



JUNIORS

10684



1



2



3



4







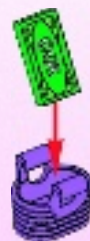
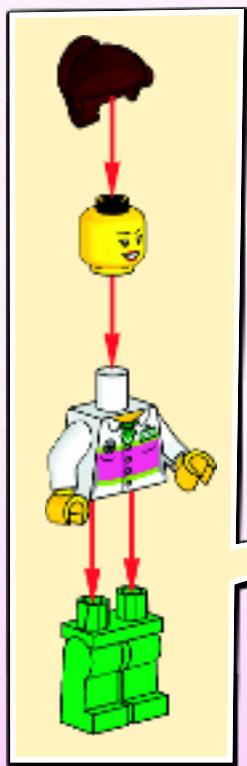

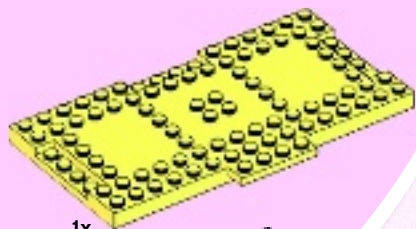

1x

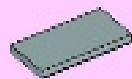

1x



2x

1

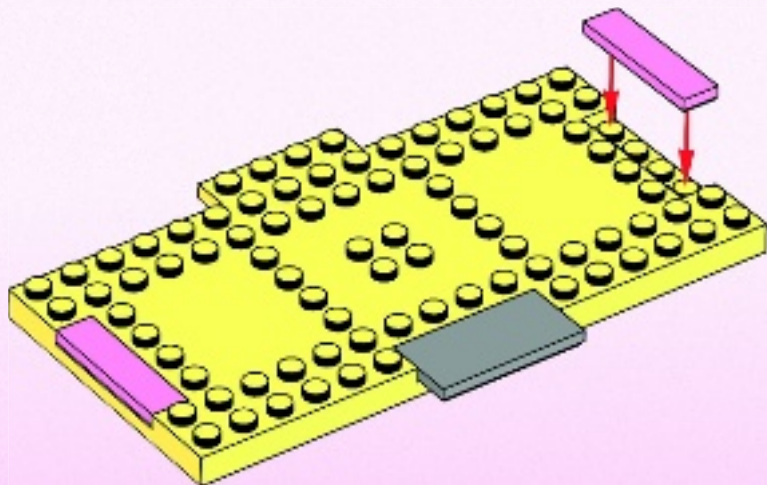

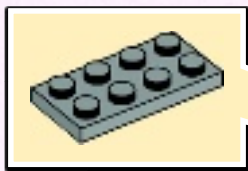

2

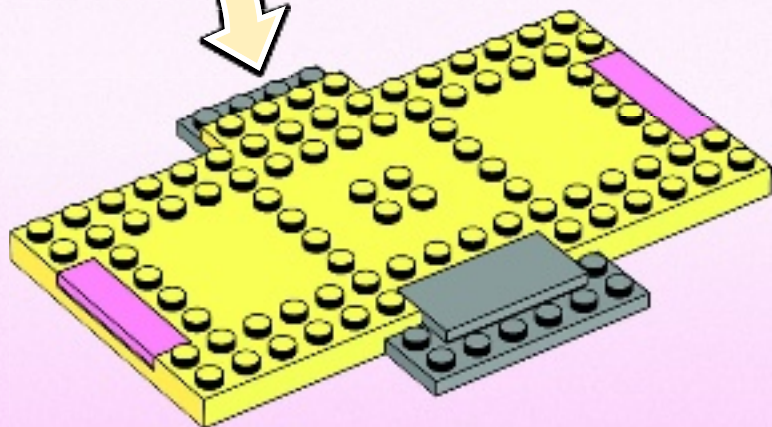

1x



1x



2x



3

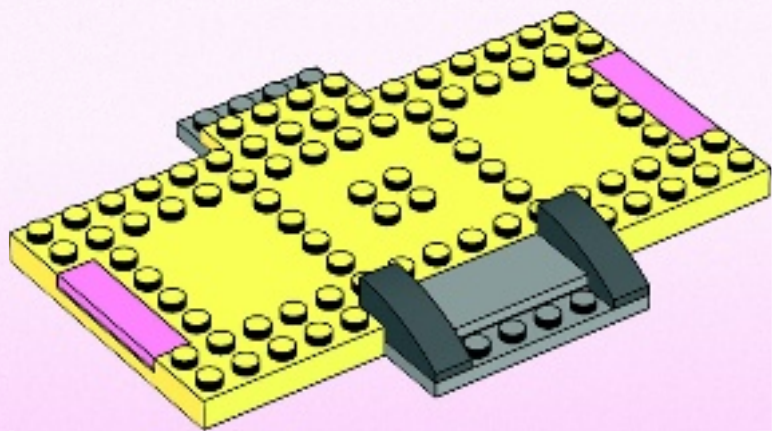

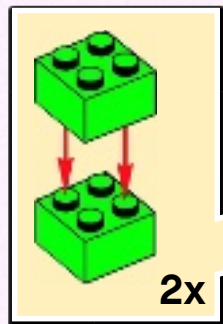

4

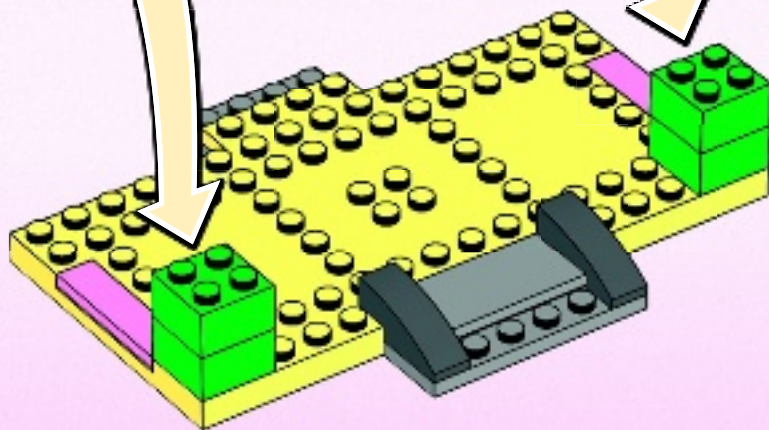

4x



2x



2x

5

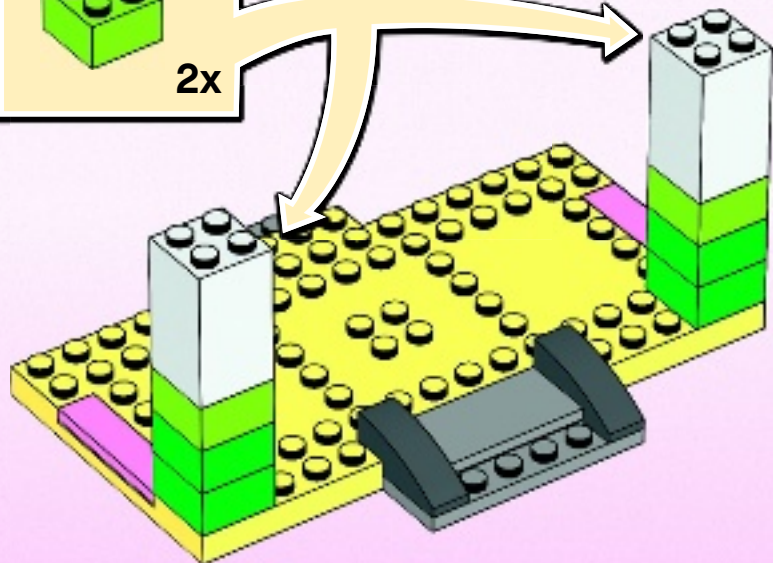
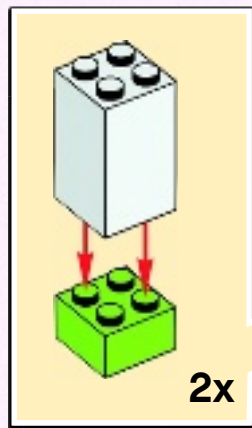

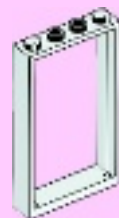
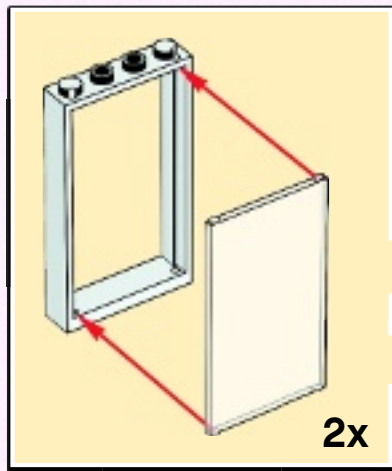

6

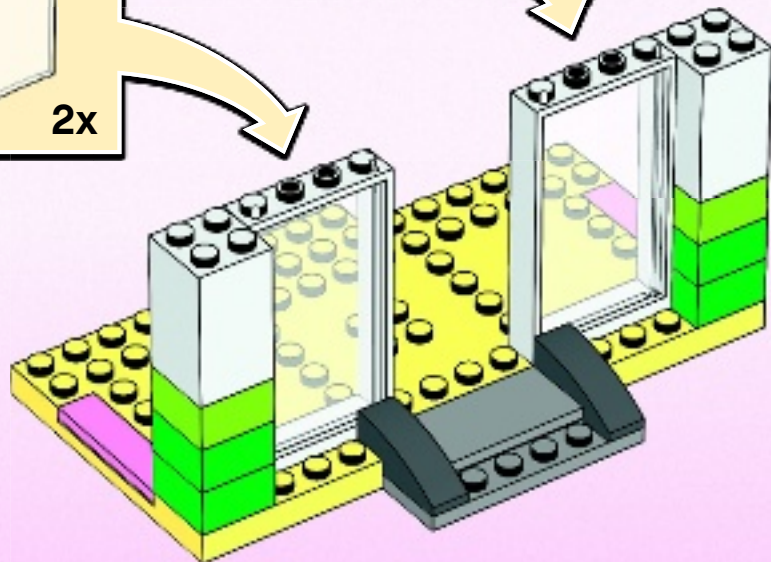

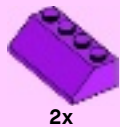

7

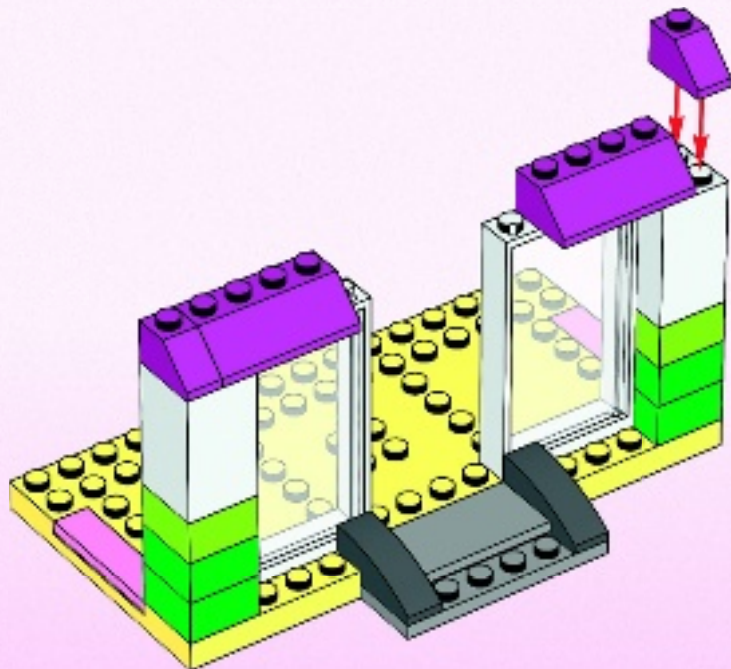

1

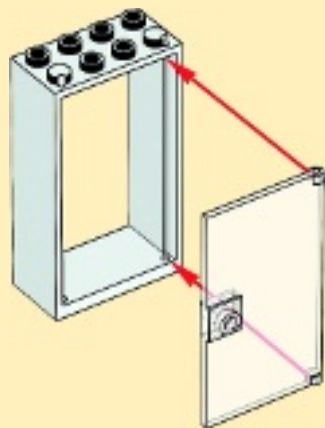

2



8

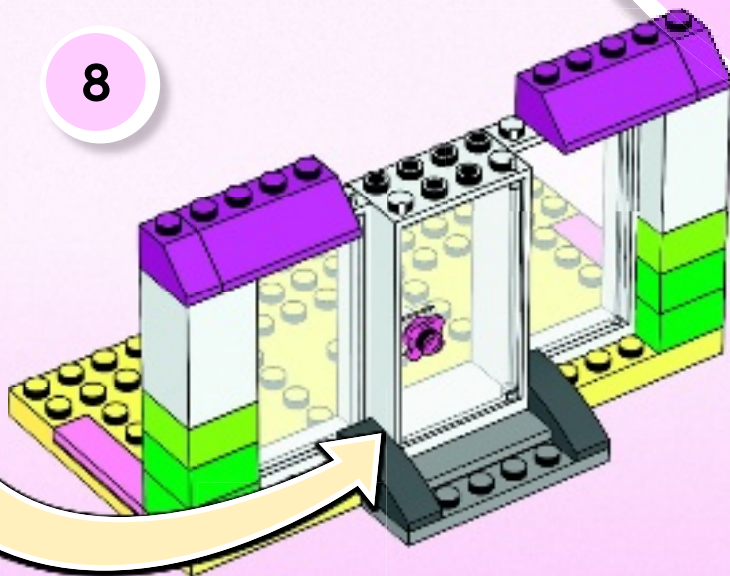

1x



1x



1x

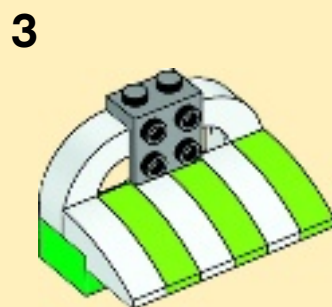
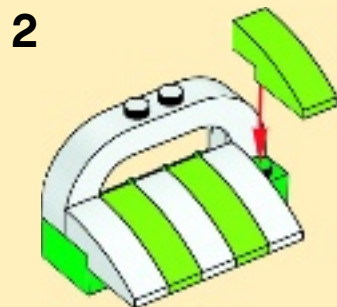
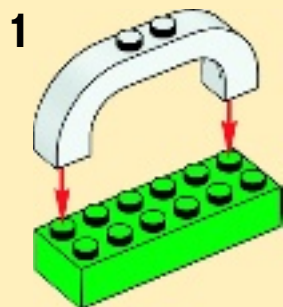
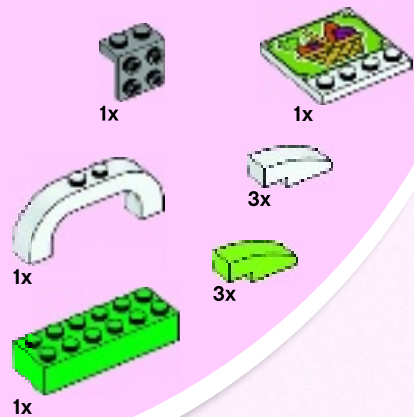

4



9

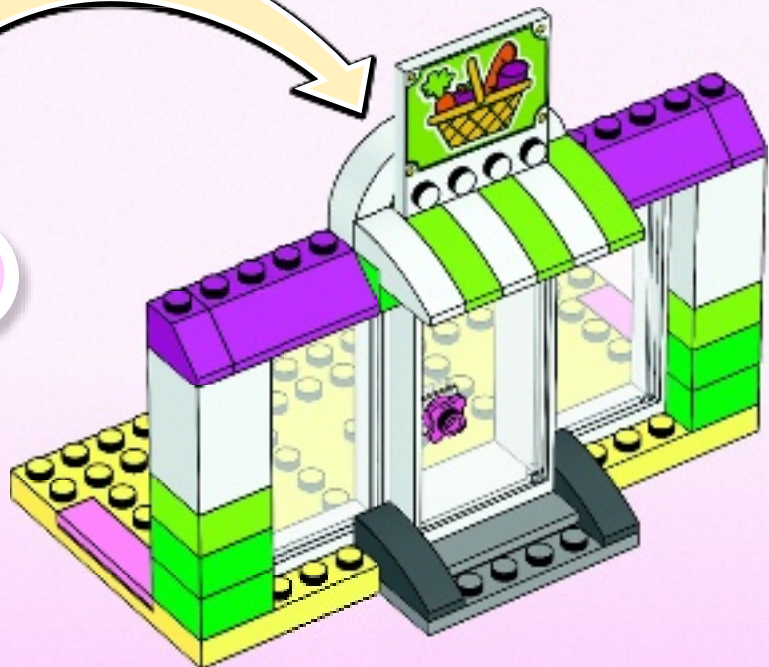



1x



1x



1x



1x



1

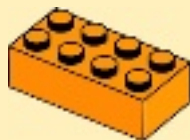

2



3





10

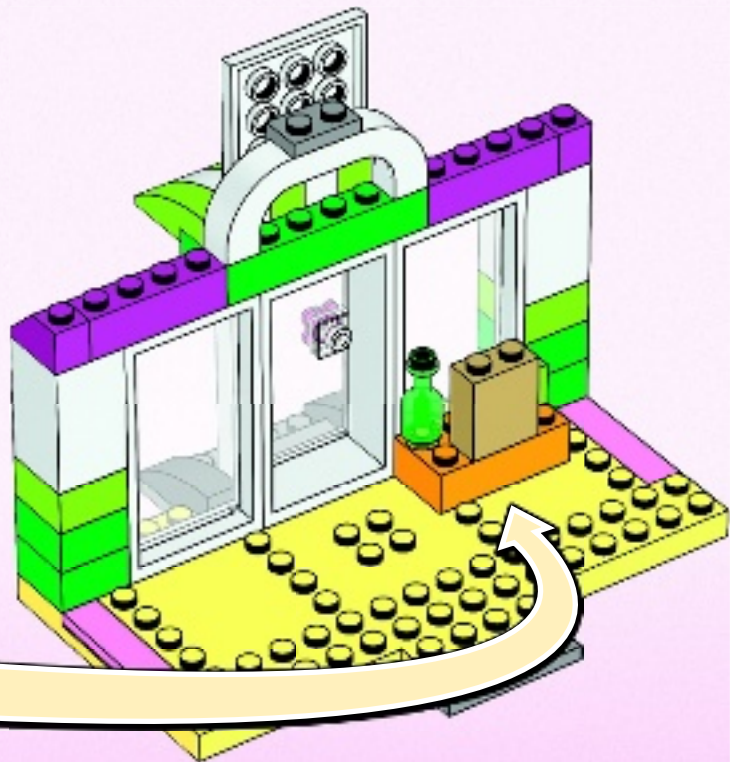



2x



2x



3x



1x



1x



1x

1



2

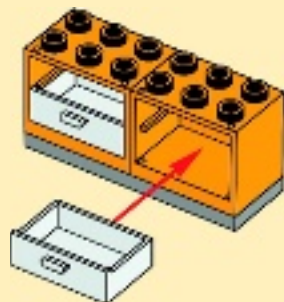

3

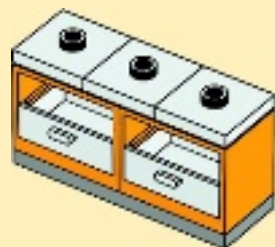

4



11

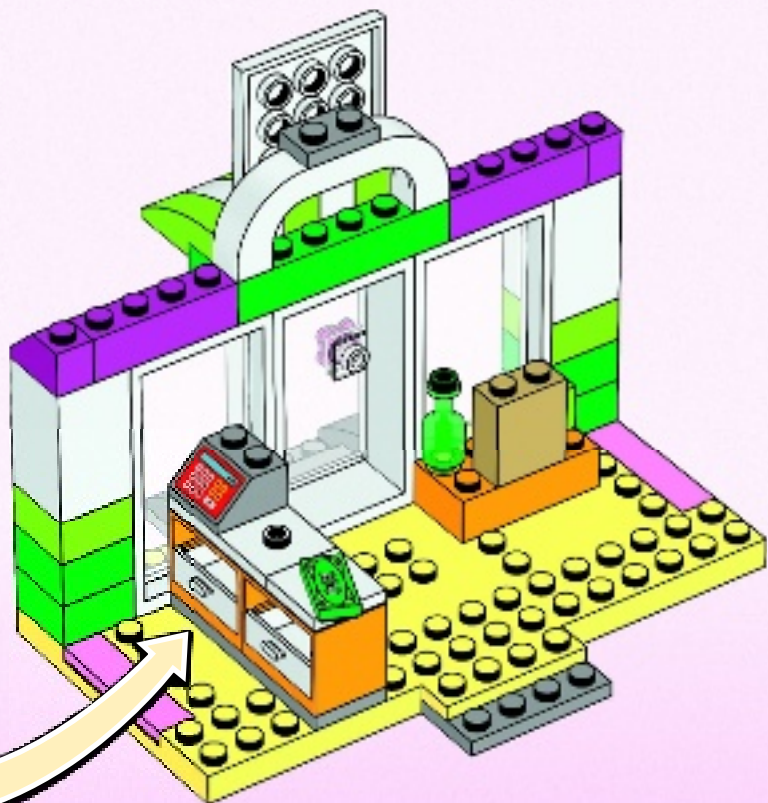



2x



1x



1x

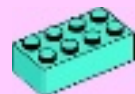

1x



1

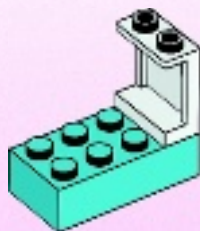

2

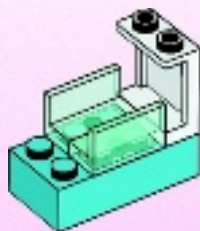

3

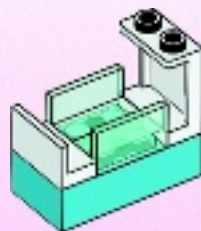

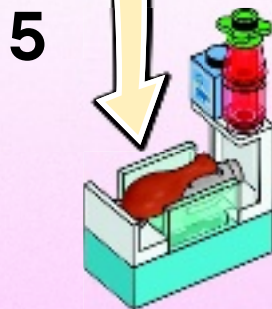
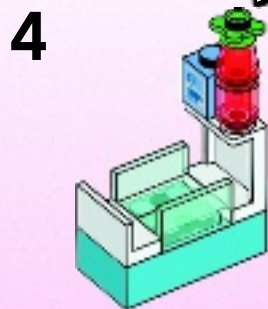
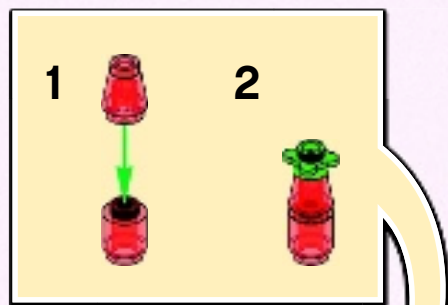

12

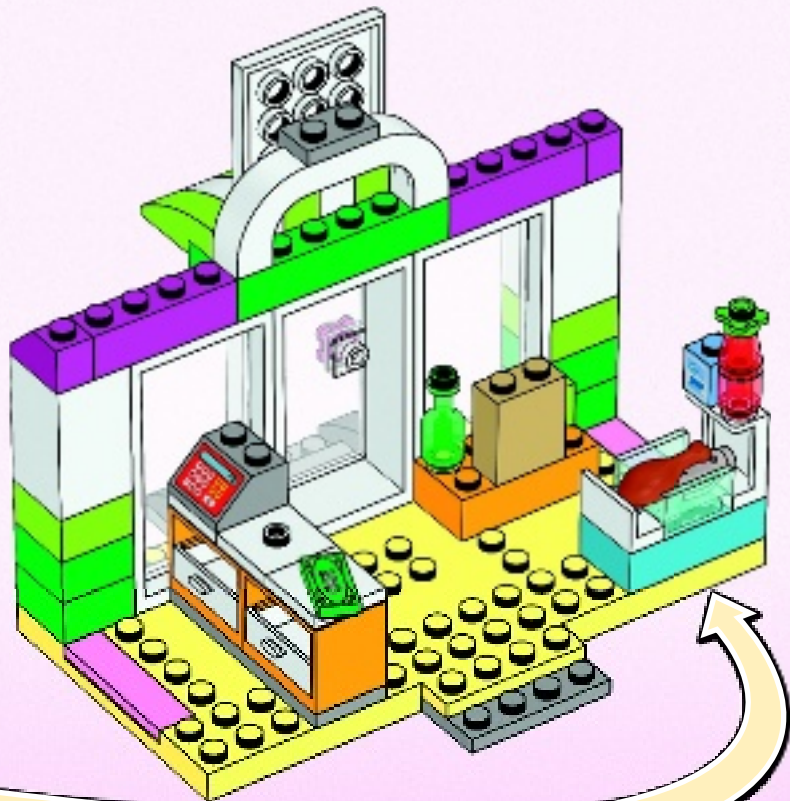

Ready for more? build and play

- Bereit für mehr? Bauen und Spielen
- Encore plus de jeu ? construis et joue
- ¿Estás preparado? ¡Más construcción y más juegos!
- Estas pronto para más? constrói e brinca
- Készen állsz MÉG TÖBB építésre és játékra?
- 想要更多么? 拼砌和玩耍

LEGO JUNIORS
4-7



...with **LEGO® Friends in Heartlake City**

LEGO.com/friends

WIN

GO TO WWW.LEGO.COM/PRODUCTFEEDBACK AND
GIVE US YOUR SHORT **FEEDBACK** ABOUT THIS
LEGO® SET FOR A CHANCE TO WIN
A COOL LEGO PRIZE.



LEGO.com/productfeedback

GEWINNE



Erzähle uns auf
www.LEGO.com/productfeedback

etwas über die Erfahrungen, die du mit
diesem LEGO® Set gemacht hast, und
sichere dir die Chance auf einen coolen
LEGO Preis!

GAGNE



Rends-toi sur
www.LEGO.com/productfeedback

et donne-nous quelques commentaires
sur ce produit LEGO® pour avoir une
chance de gagner un prix LEGO !

GANAN



Visita
www.LEGO.com/productfeedback

y envíanos tu opinión acerca de este set
LEGO®. ¡Participarás en el sorteo de un
premio LEGO!

获取奖品



登录
www.LEGO.com/productfeedback

给出关于此乐高®套装的简短反馈，
就有机会获得炫酷乐高奖品