



DC COMICS  
**SUPER  
HEROES**



76028



1



2



3



4





[LEGO.com/brickseparator](https://LEGO.com/brickseparator)



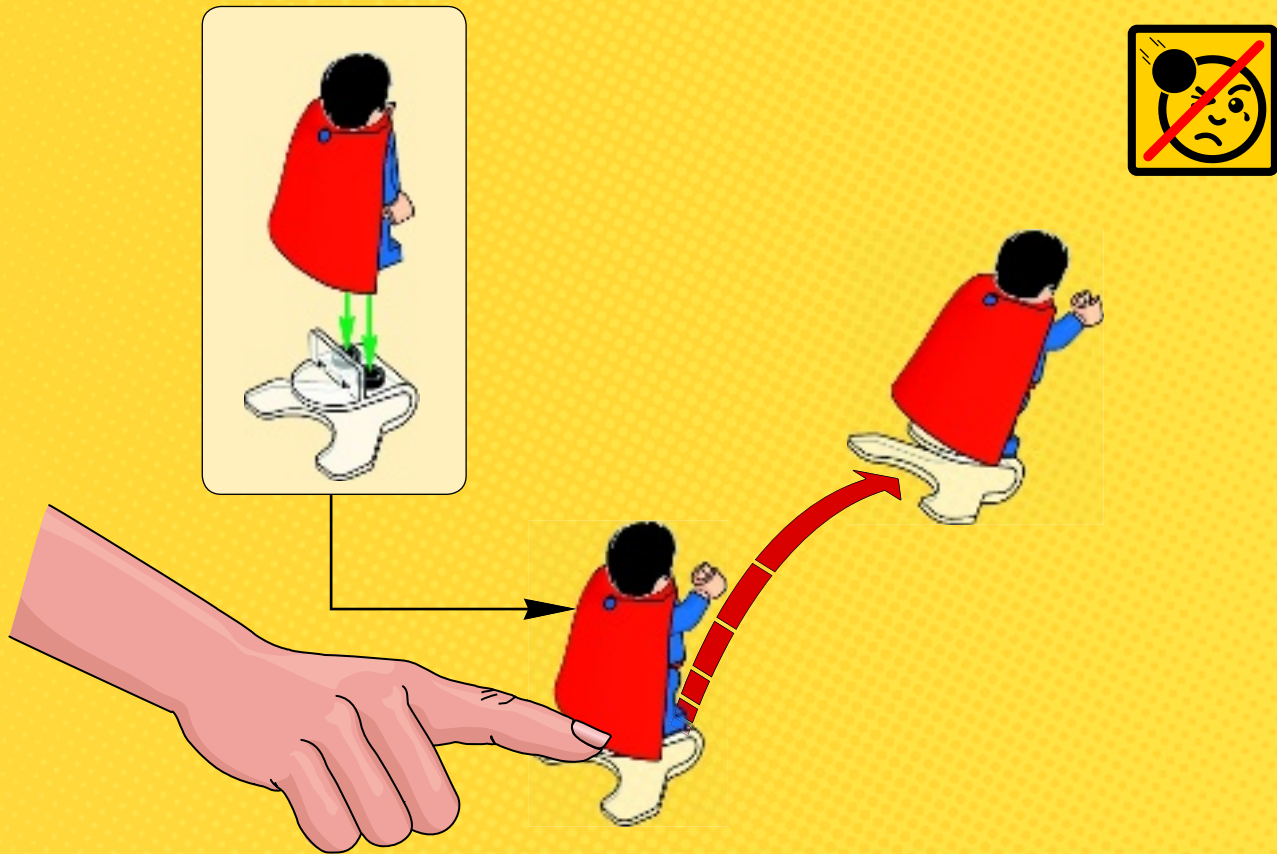

1



2



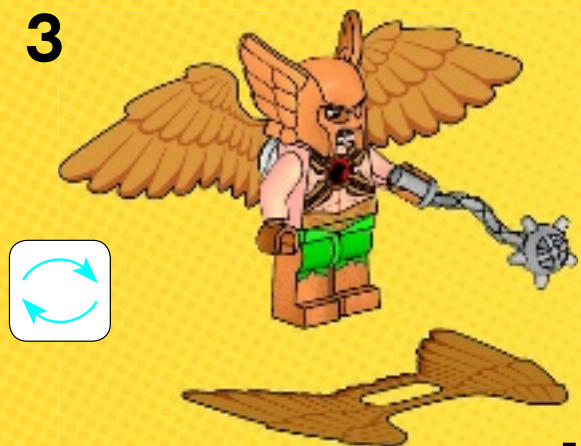
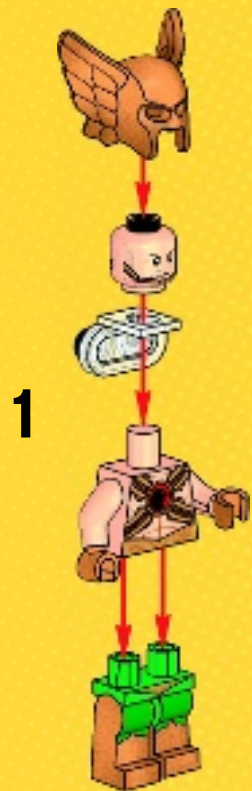



1



2







3

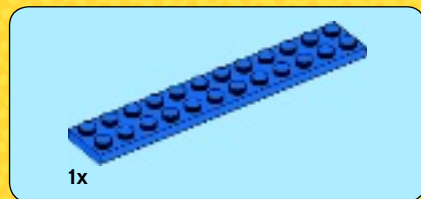

4

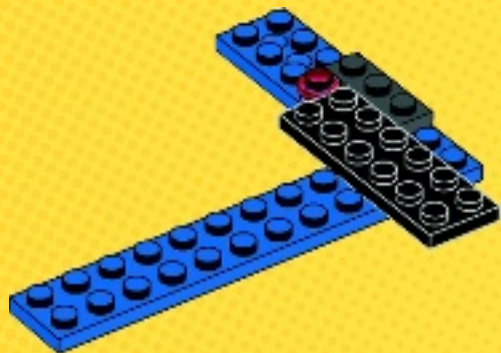



5

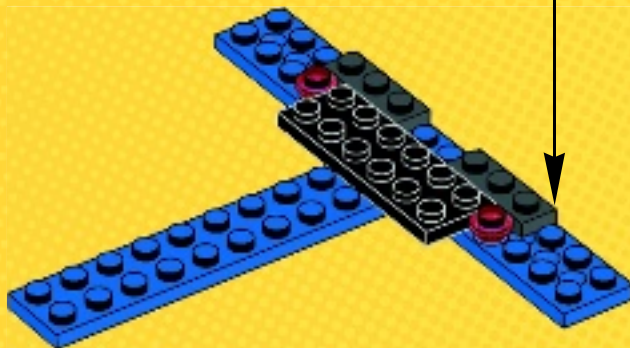
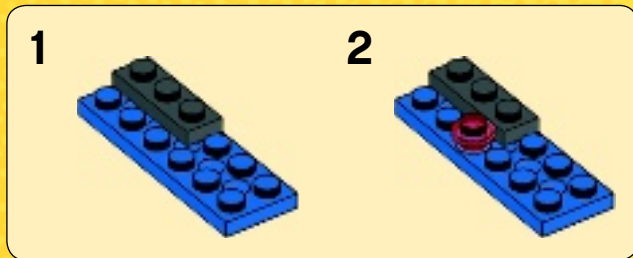



2x

6

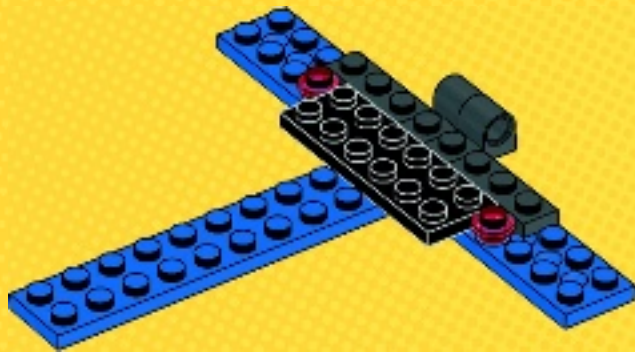



4x

7

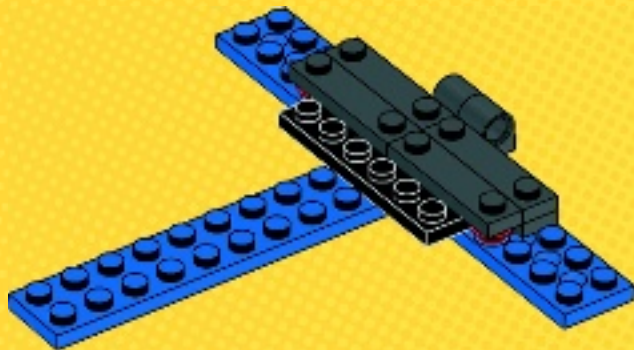



2x



2x

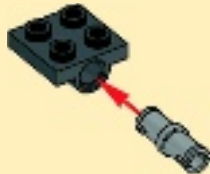

2x

8

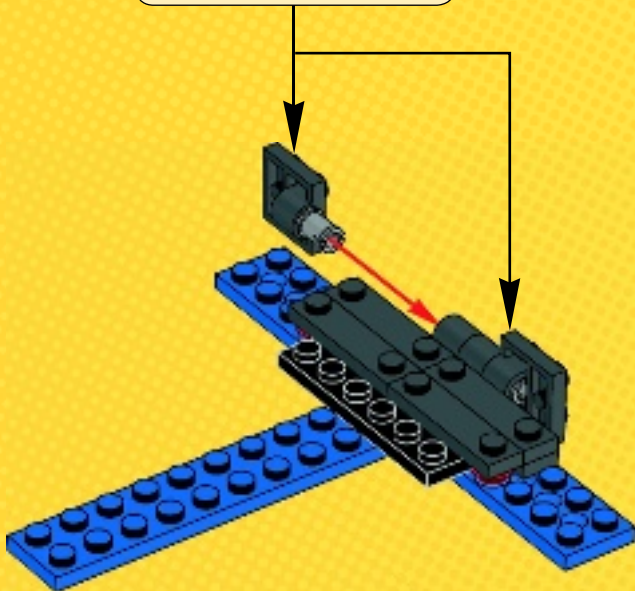



2x



1x

9

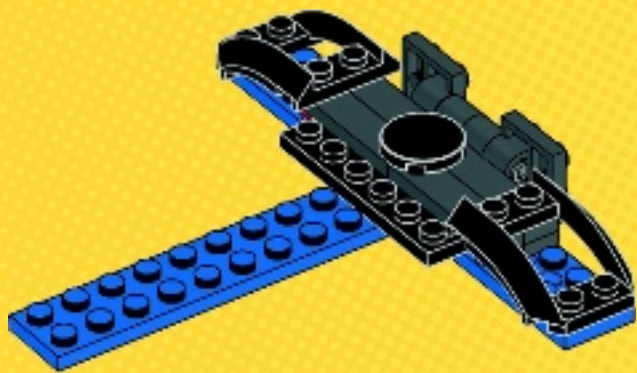



2x

10

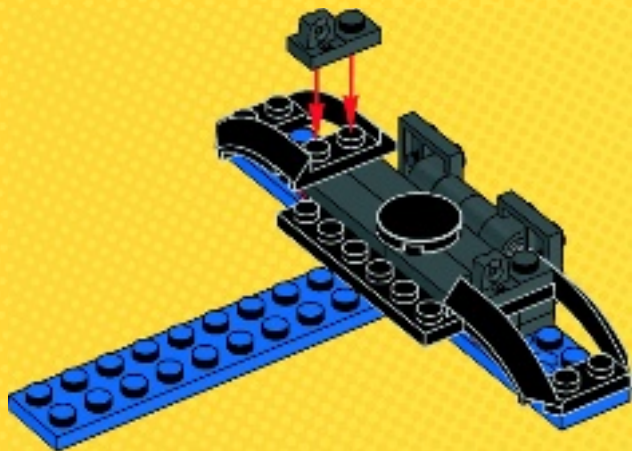



1x

1



2x

2







2x

3



1x



1x

4





1x

5



11

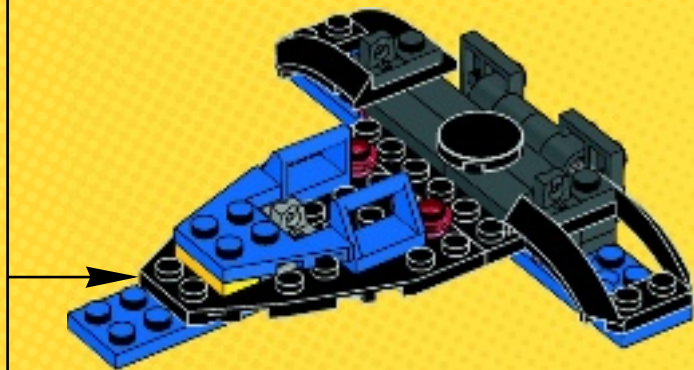



1x



2x

# 12

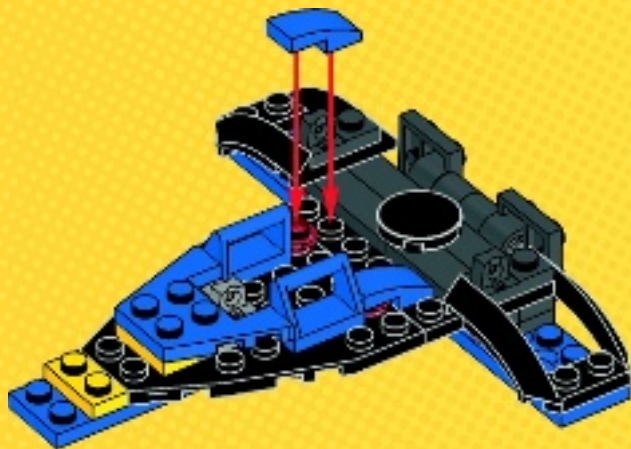



1x

13

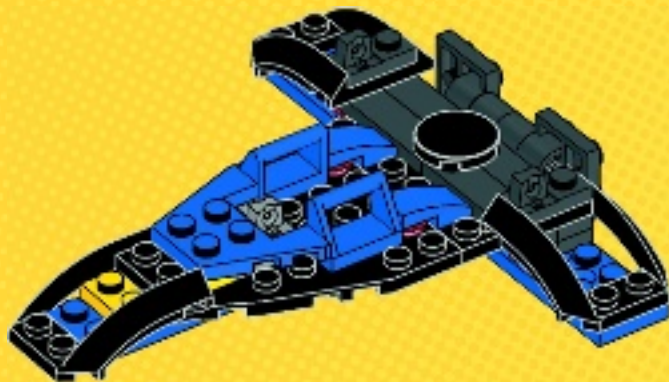



1x

14

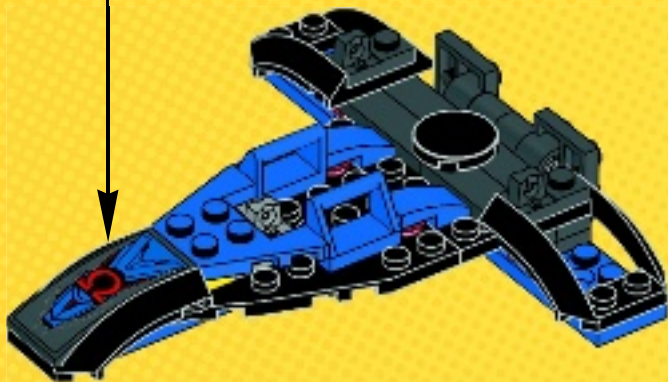



15

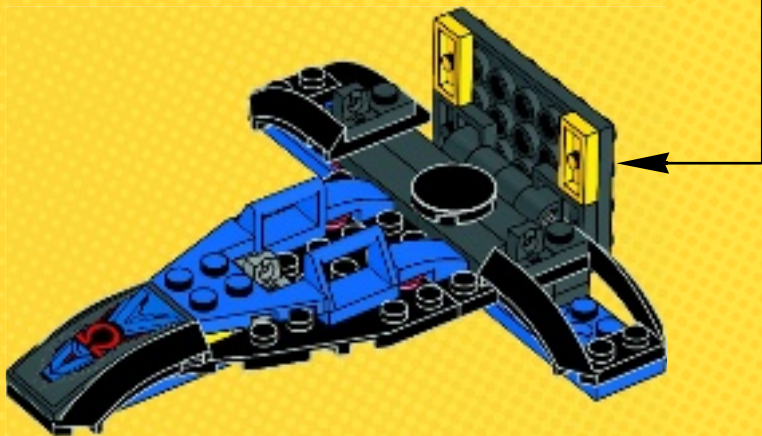
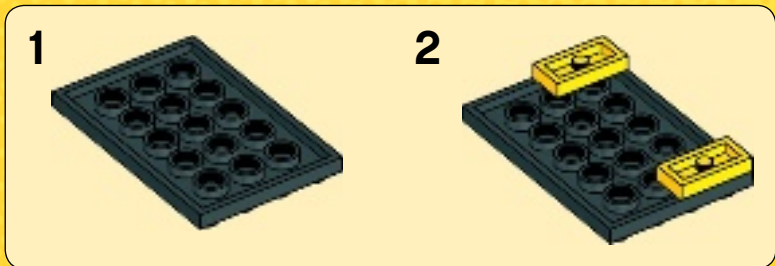

# 16

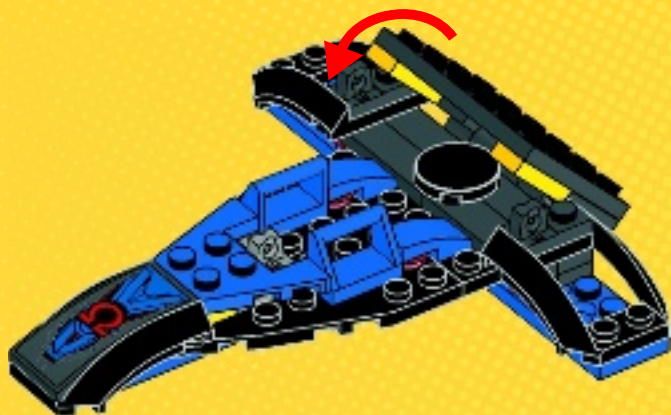

# 17

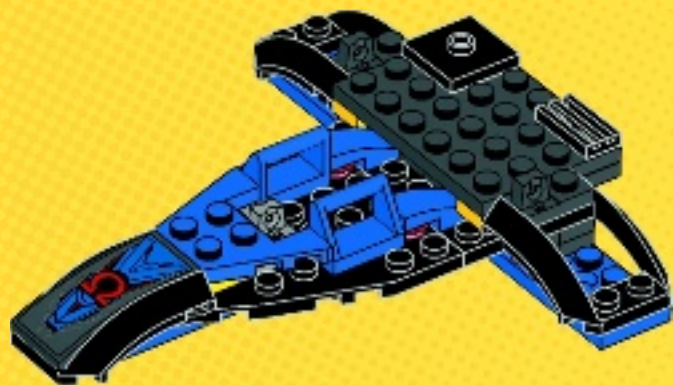

1x

1x



1x



2x



1x

# 18

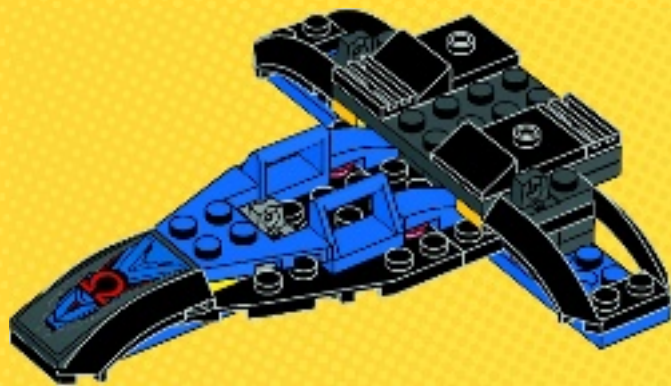



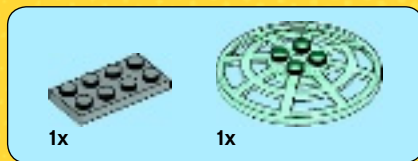

19

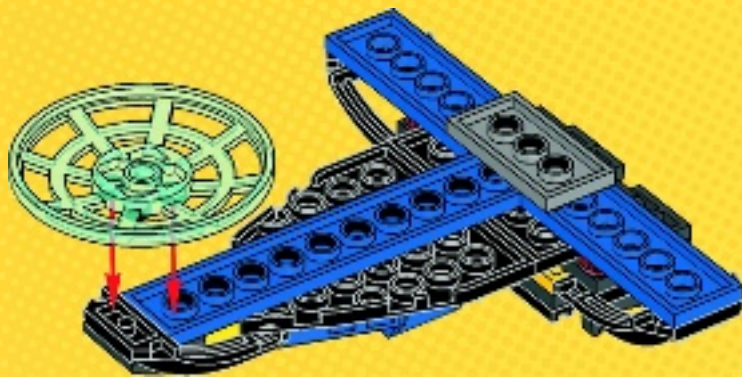



1x

20

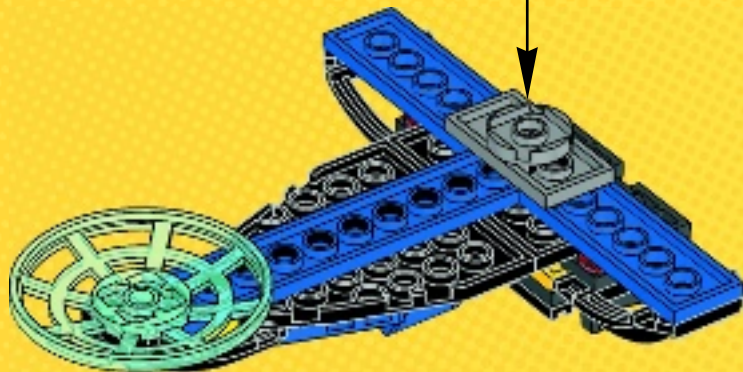



21

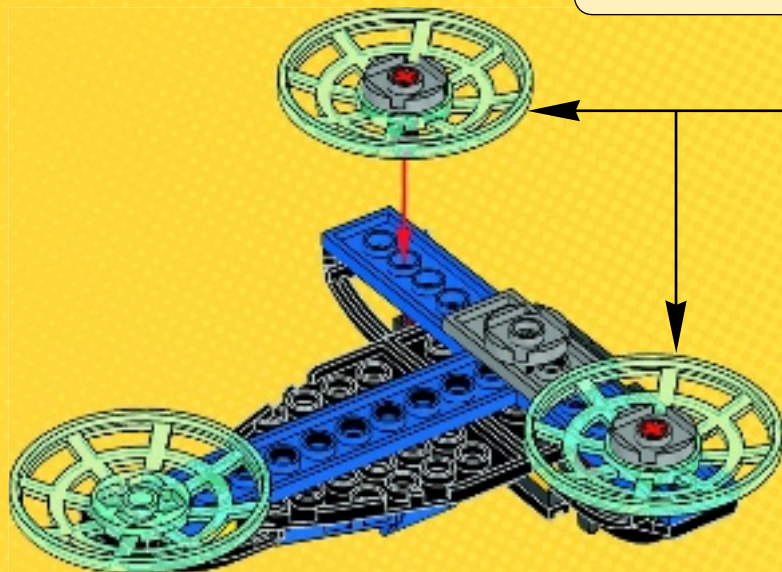
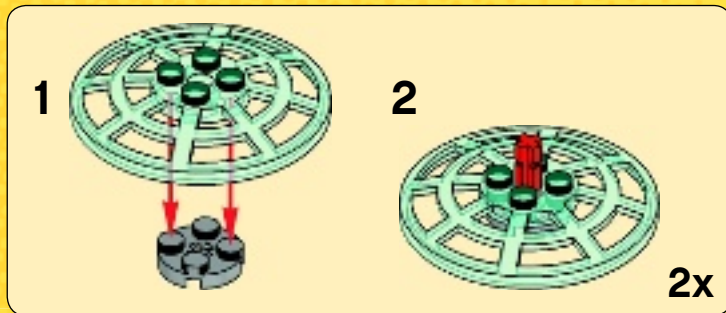



2x

22

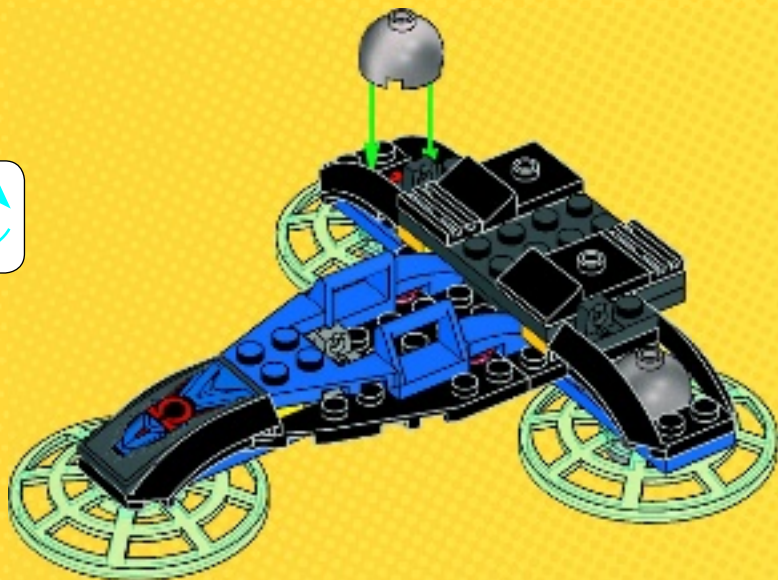



23

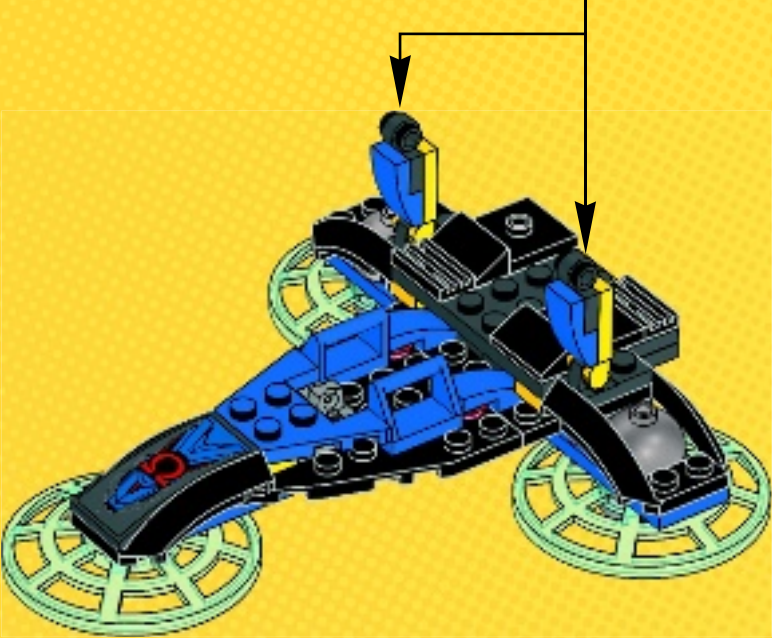
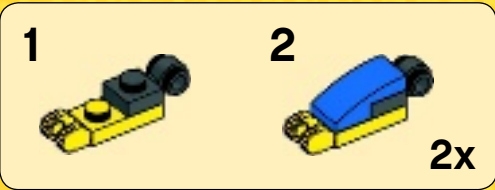

24

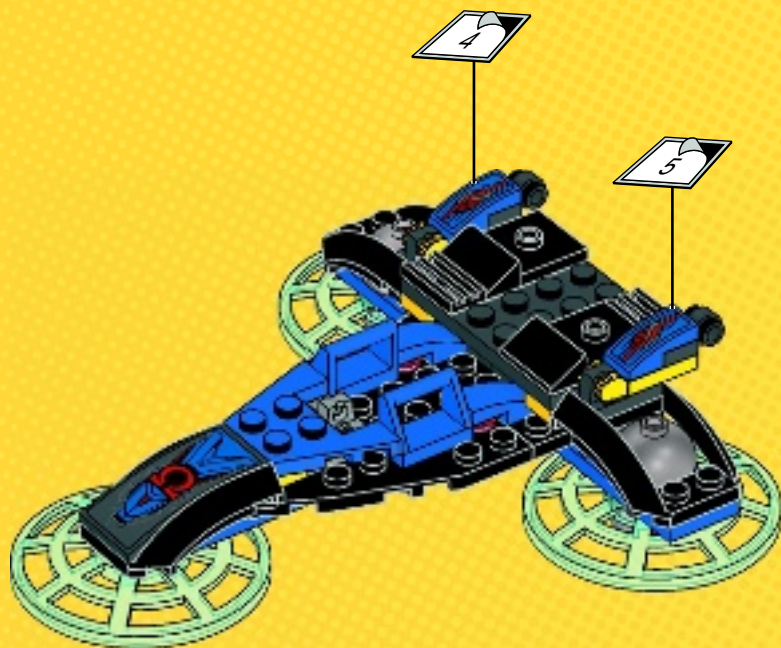

25

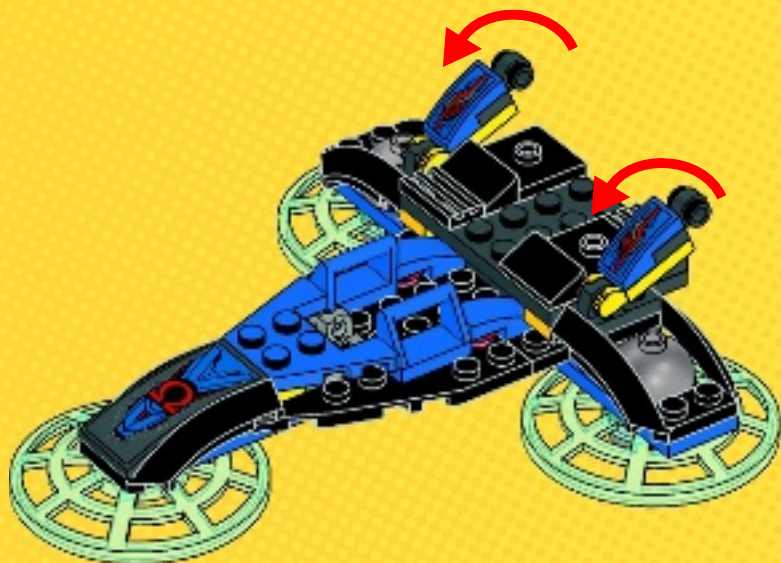

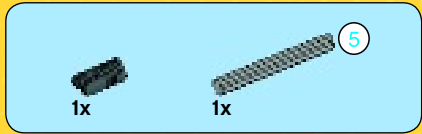

1



2







3



4



26

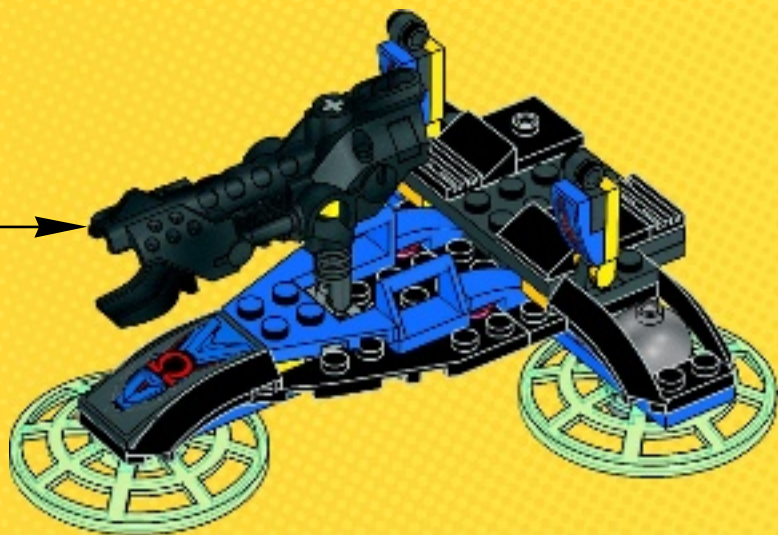



2x

27

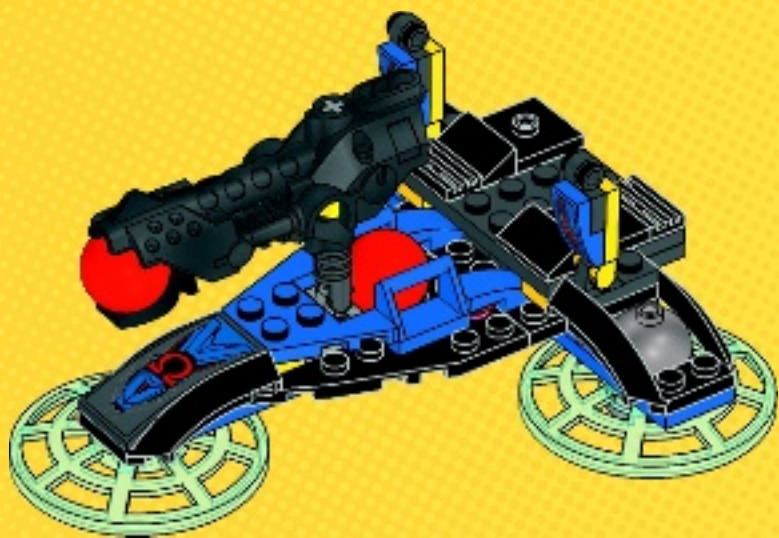

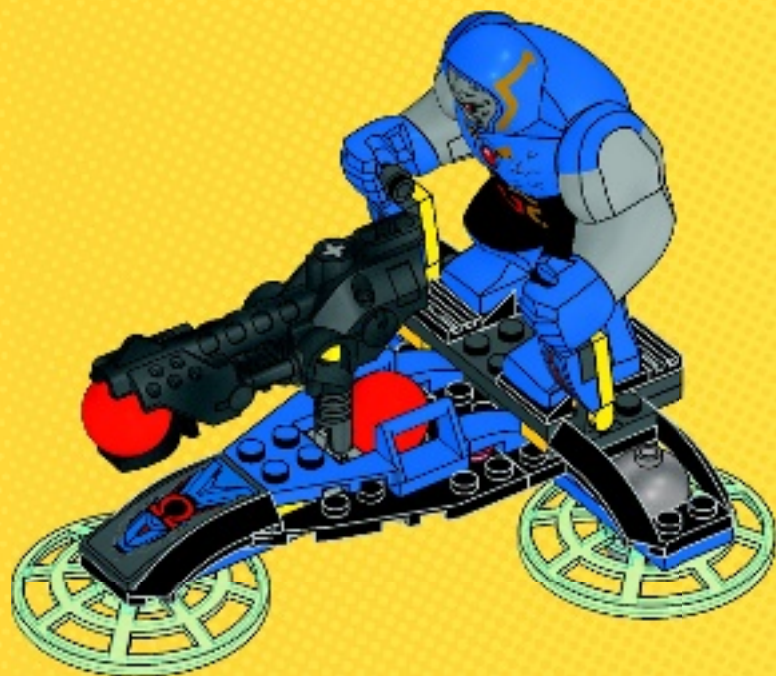





LEGO

# BATMAN 3

## BEYOND GOTHAM



7

[www.pegi.info](http://www.pegi.info)

PROVISIONAL

Check the Classification

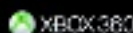

PC

Wii U

NINTENDO 3DS

Nintendo eShop



© 2014 The LEGO Group.™ & © DC Comics.™ & © WB. (3/14)

# IT'S AN ALL-NEW LEGO® MOVIE!

LOOK FOR IT ON BLU-RAY,™  
DVD AND DIGITAL HD



LEGO, the LEGO logo and the Minifigure are trademarks of the LEGO Group.  
©2015 The LEGO Group.

© 2015 Warner Bros. Entertainment Inc.

JUSTICE LEAGUE and all related characters and elements are trademarks of and © DC Comics.

NOT RATED

[dccomics.com](http://dccomics.com)

[warnervideo.com](http://warnervideo.com)



DC  
COMICS™



# DC COMICS **SUPER HEROES**



76025



76026



76027



76028



LEGO and the LEGO logo are trademarks of the LEGO Group. ©2015 The LEGO Group.

DC Comics characters and all related elements are trademarks of and © DC Comics.

WB SHIELD: TM & © Warner Bros. Entertainment Inc.  
(s15)

6112309