



# CITY

60080



 [LEGO.com/city](https://www.lego.com/city)



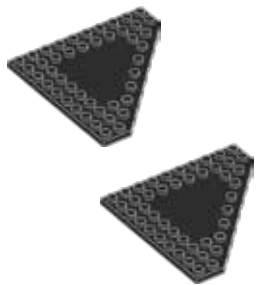

+

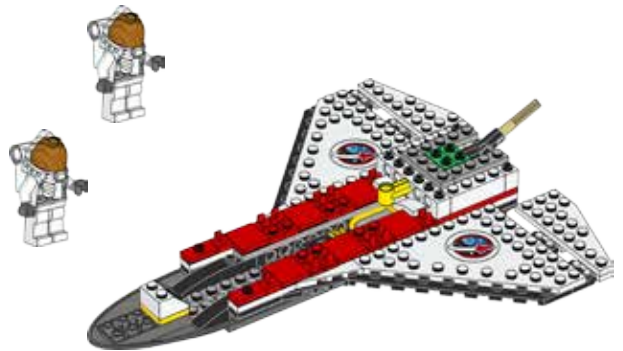
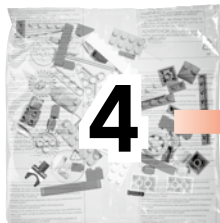

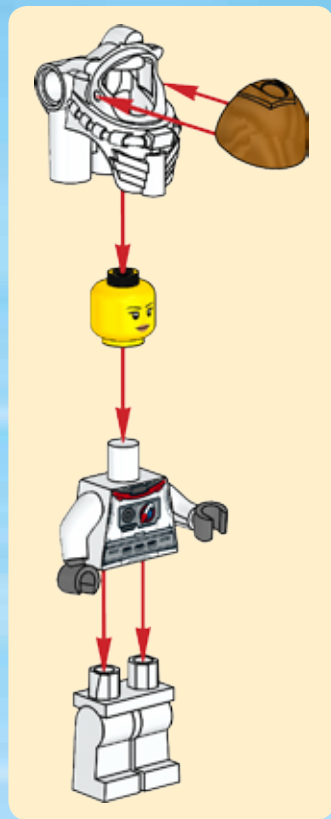
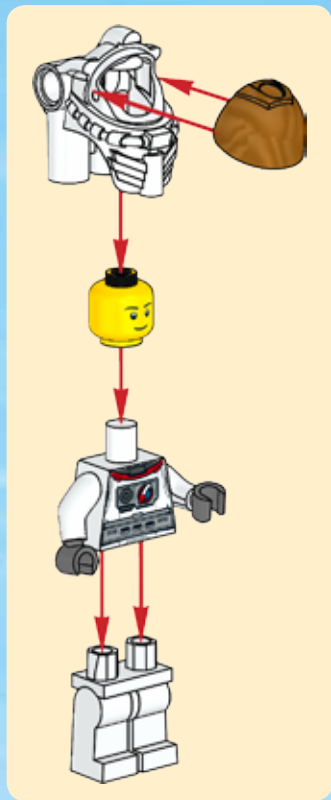

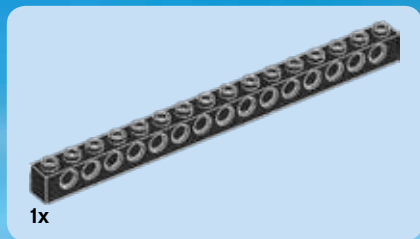

1x

**1**

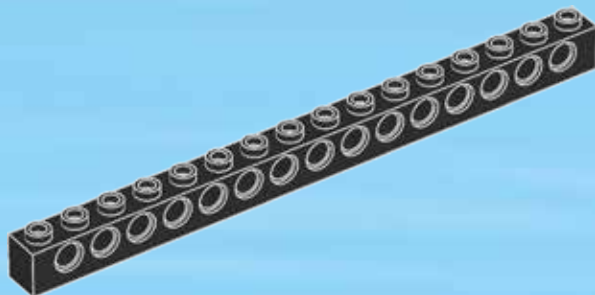



2x

2

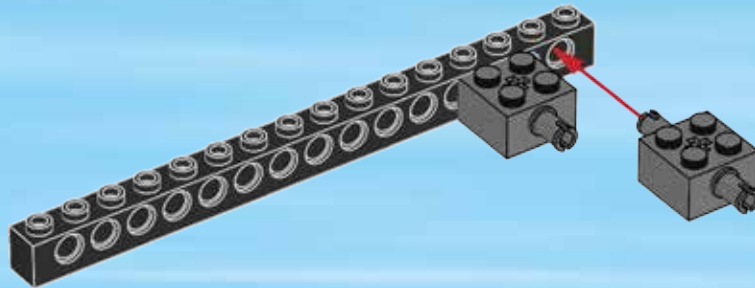



1x



1x

3

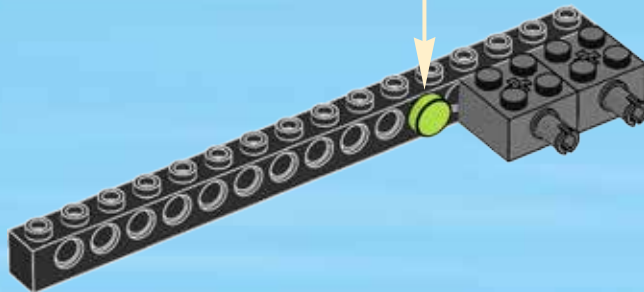



2x

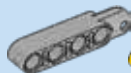

1x



2x



2x

# 4

## 1



## 2

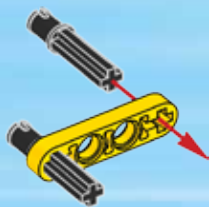

## 3



## 4

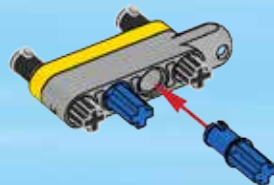

5

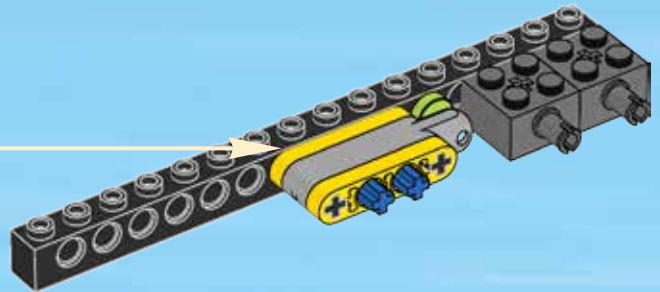



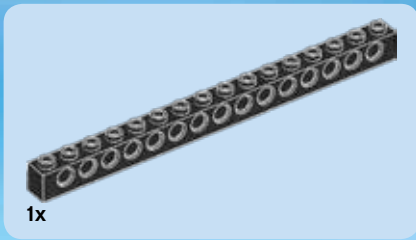

1x

5

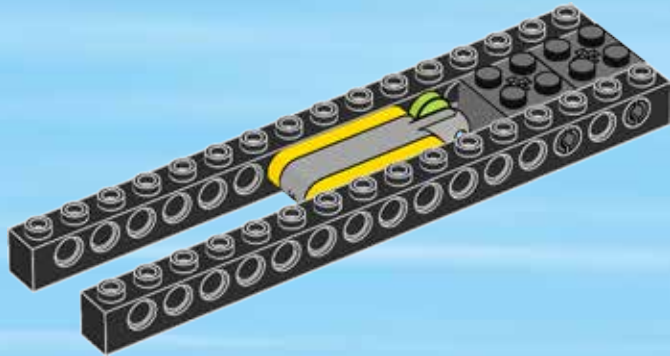



1x

6

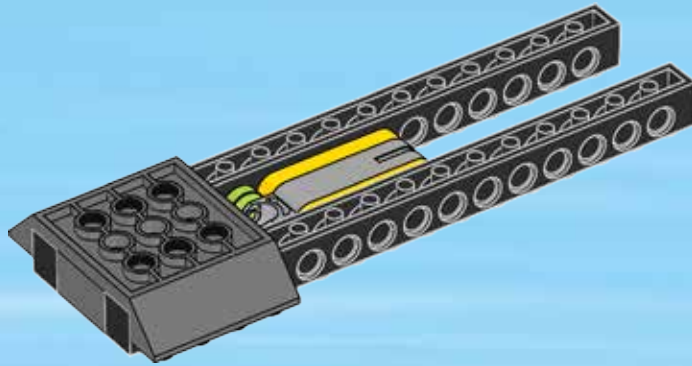



2x

7

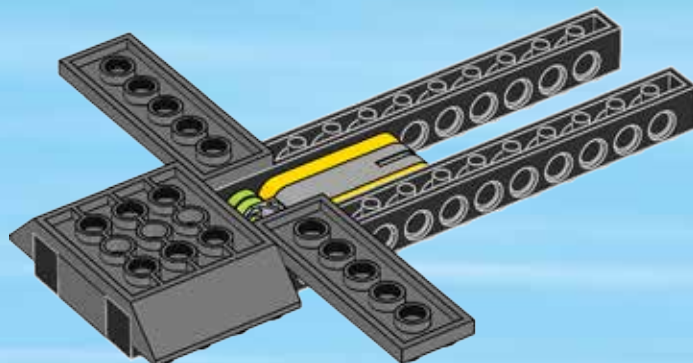

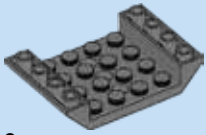

3x

8

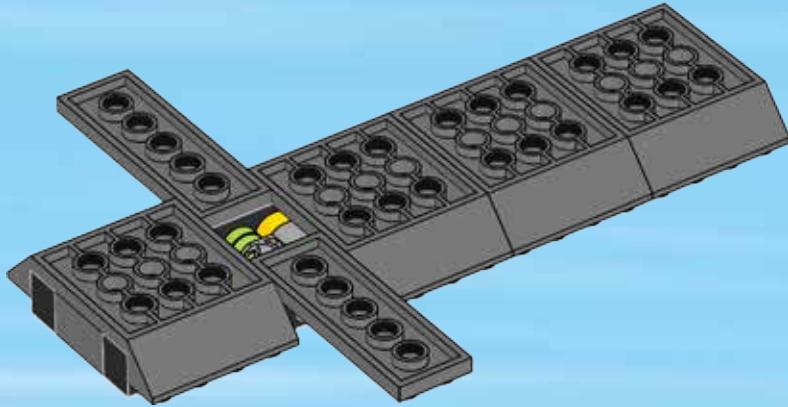

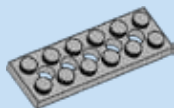

1x

9

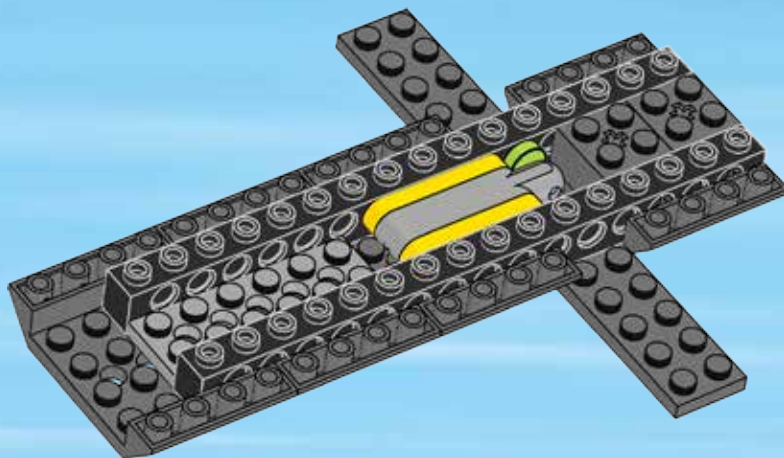



1x



1x

# 10

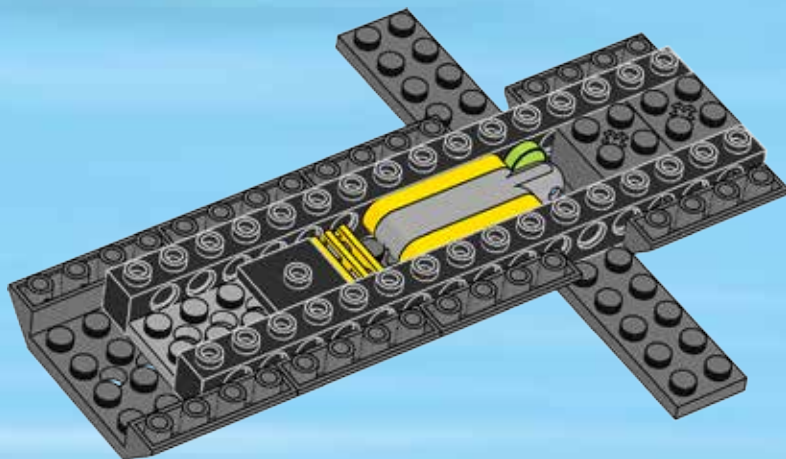



2x



4x

# 11

1



2



2x

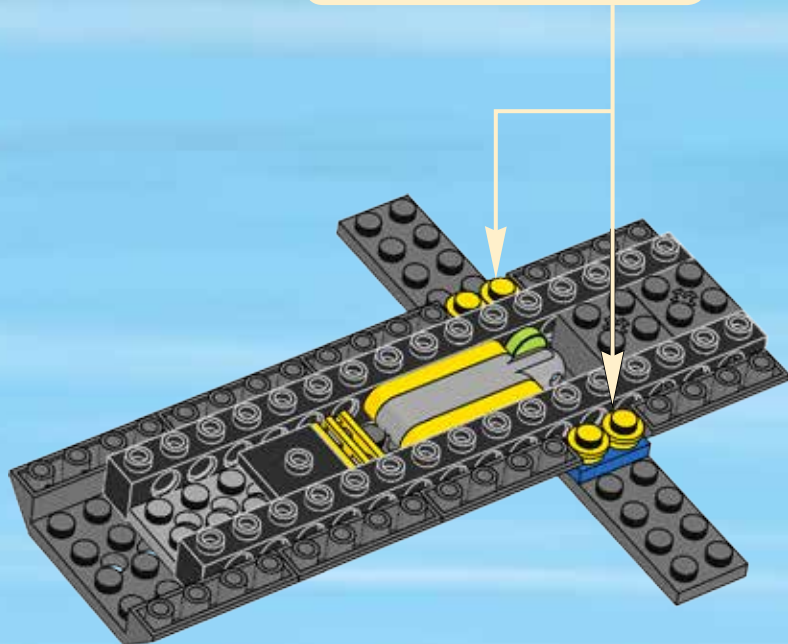

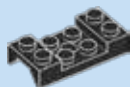

2x

# 12

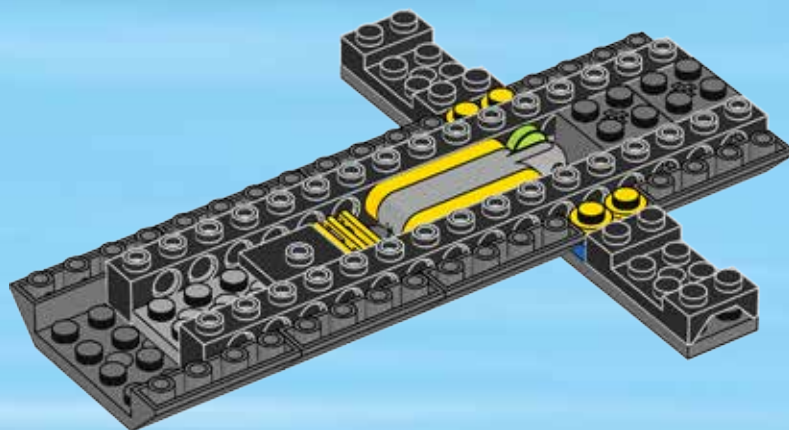





2x

13

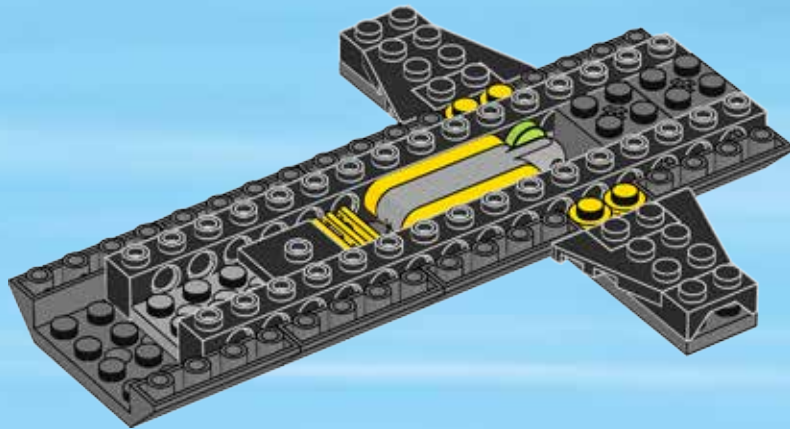



2x

# 14

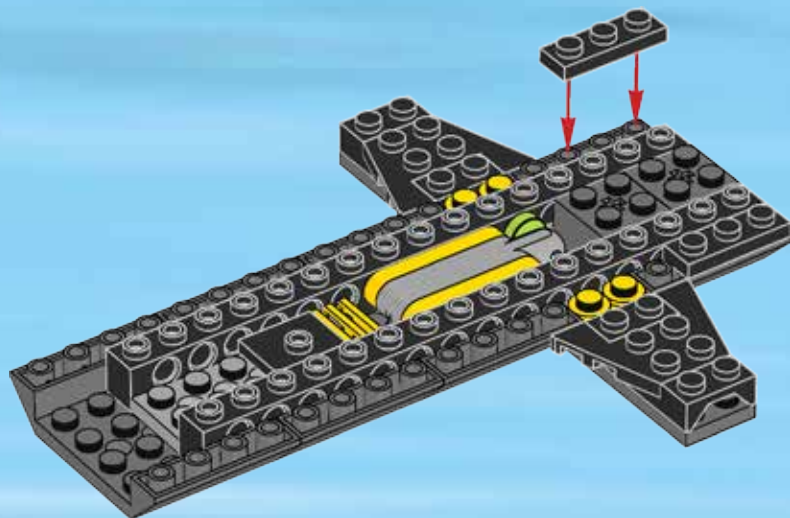

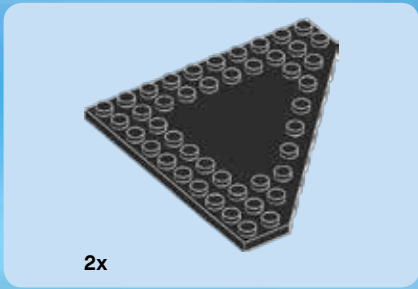

15

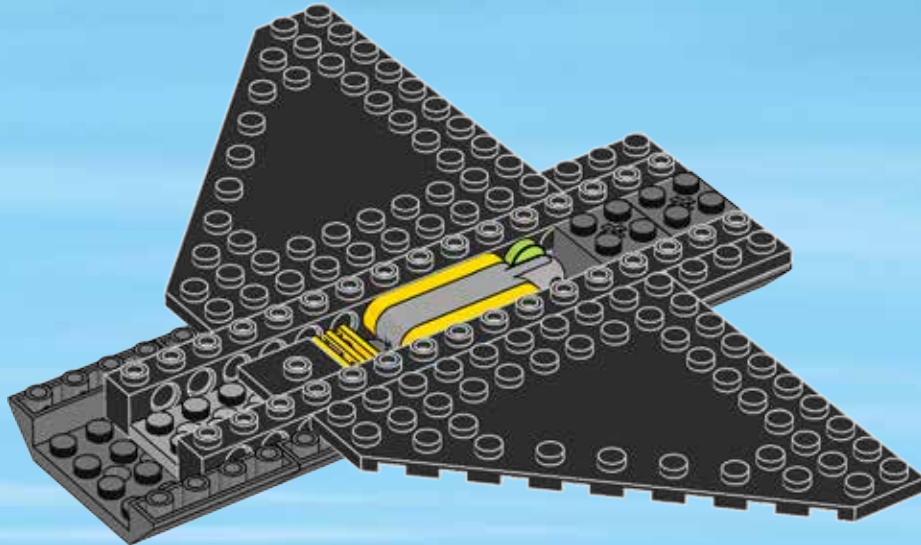

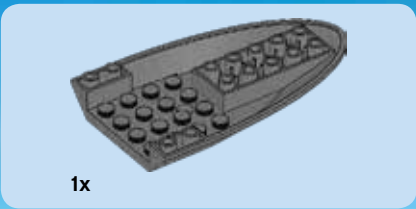

# 16

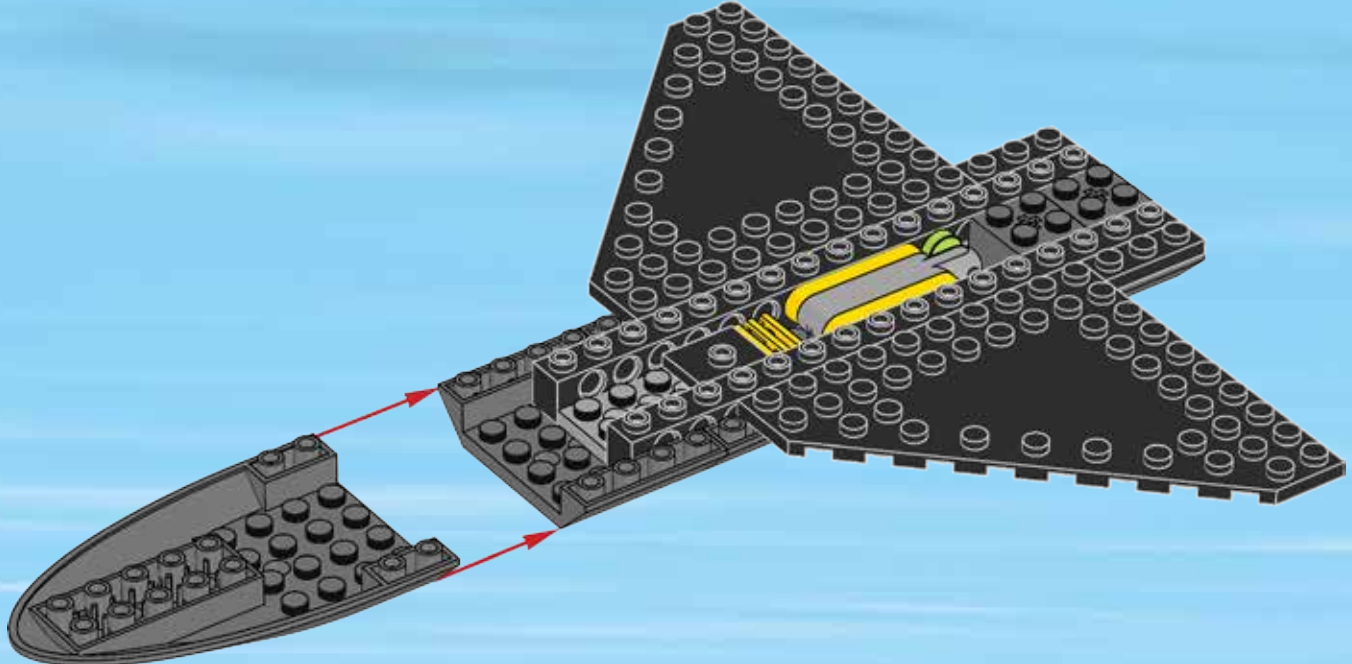

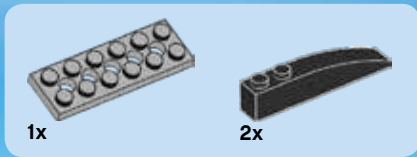

# 17

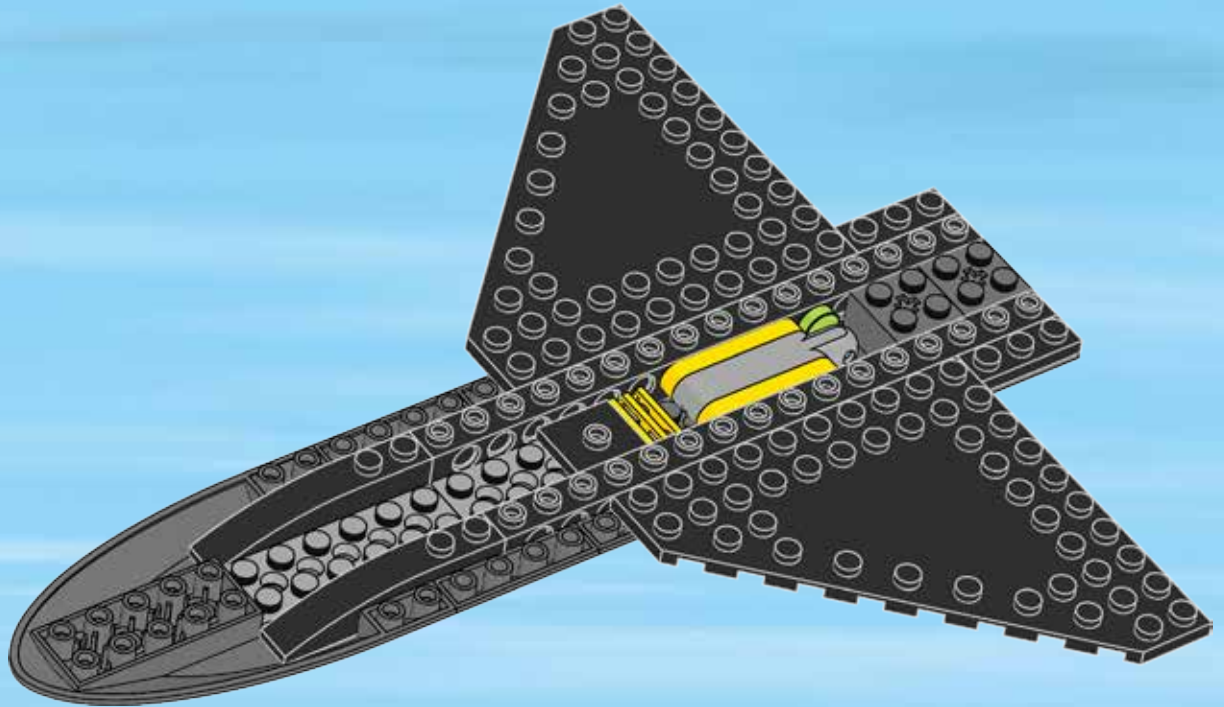



1x



1x

# 18

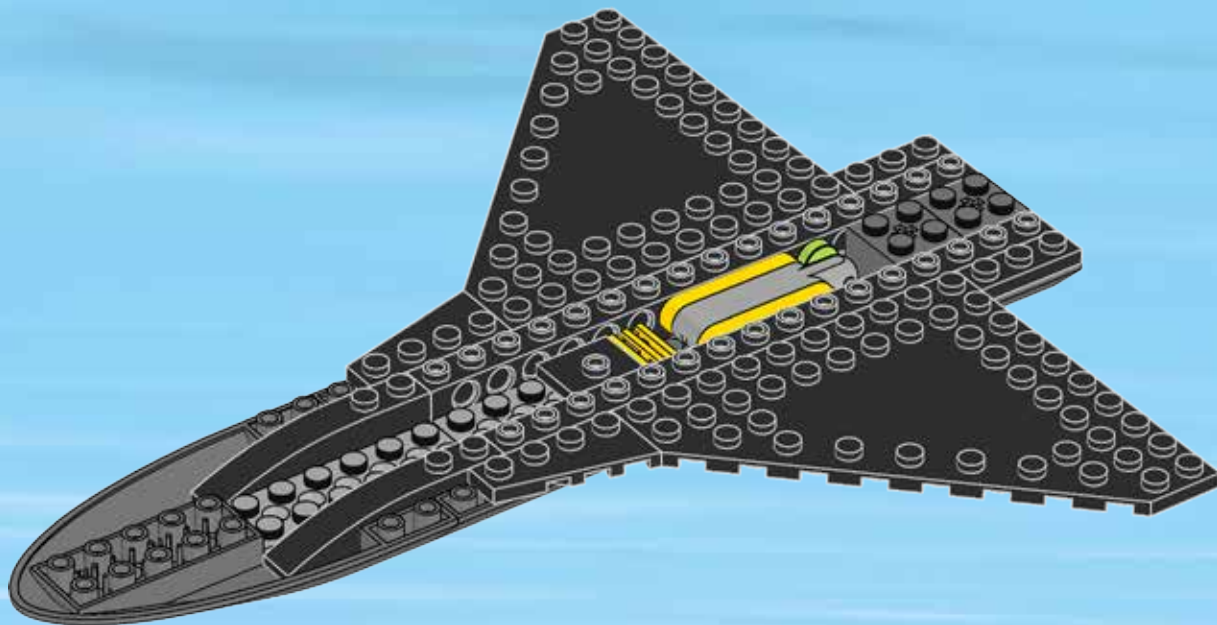



2x



1x

# 19

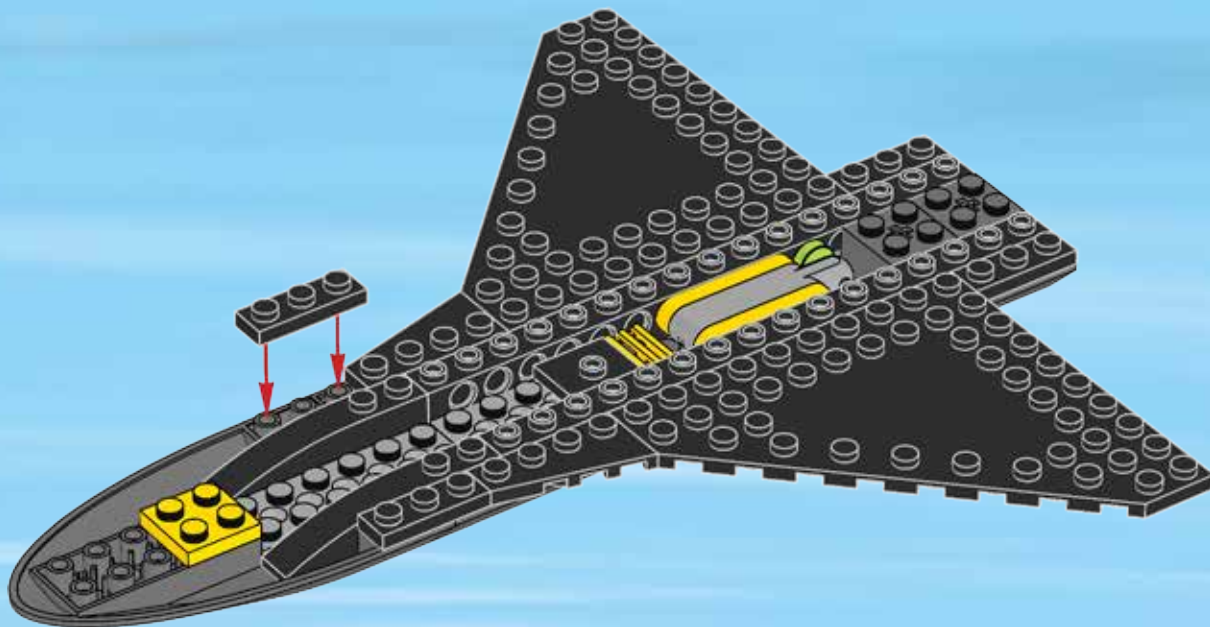

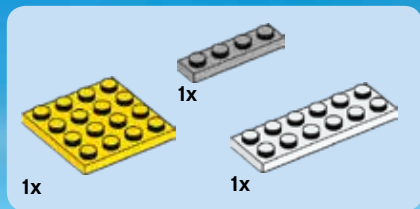

20

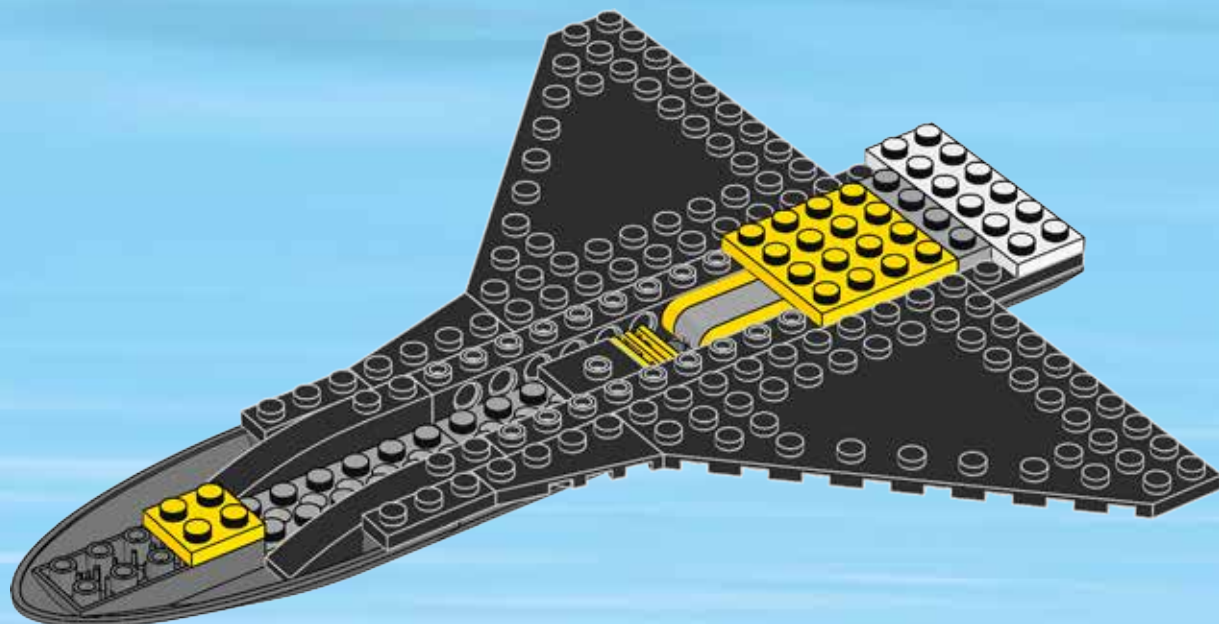





2x

21

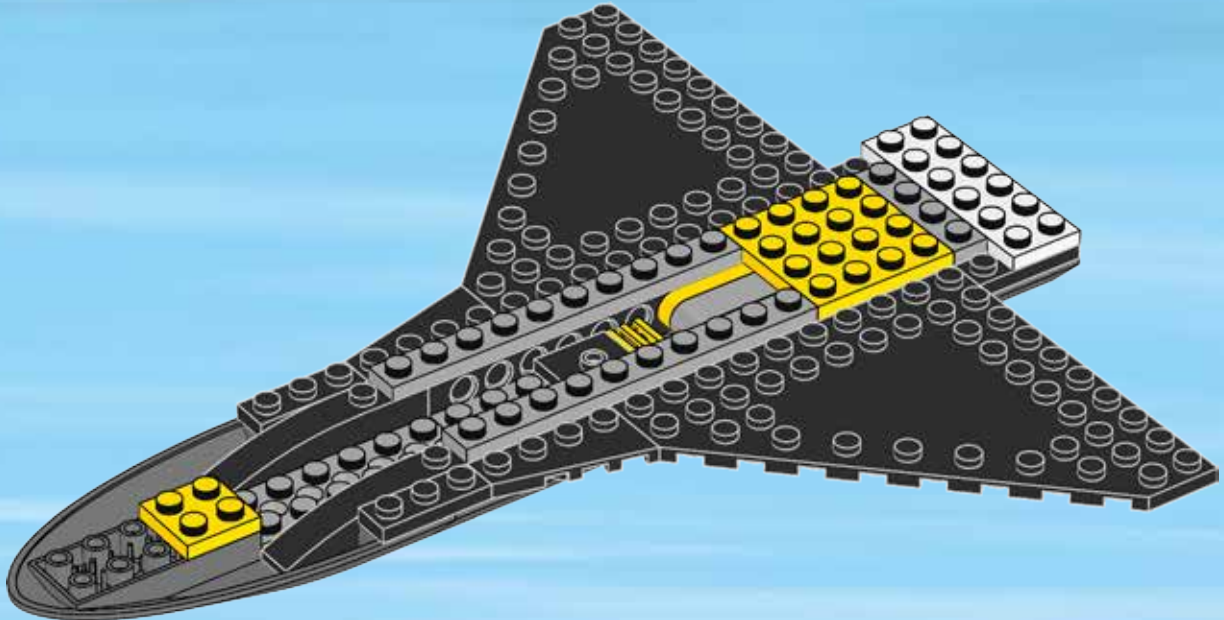

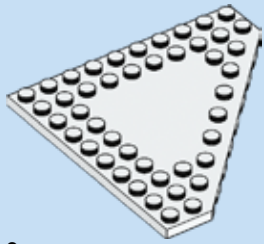

2x

22

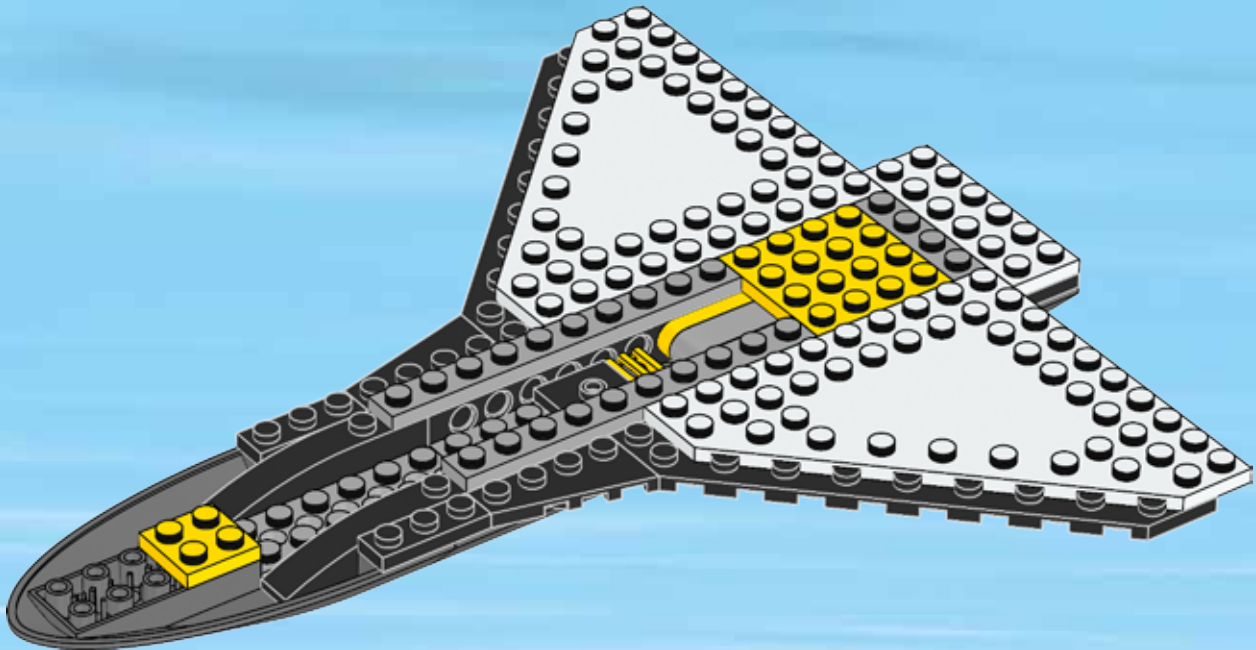

23

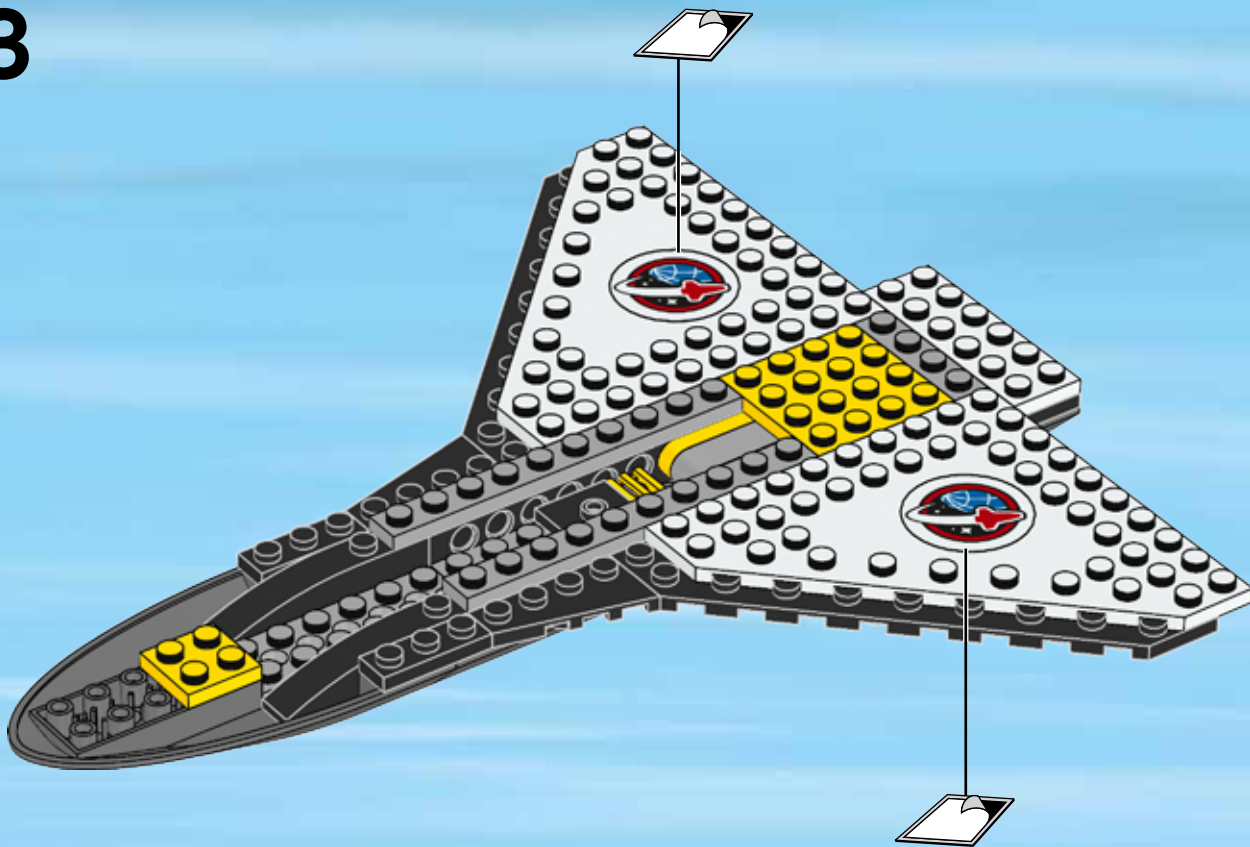



1x



1x

# 24

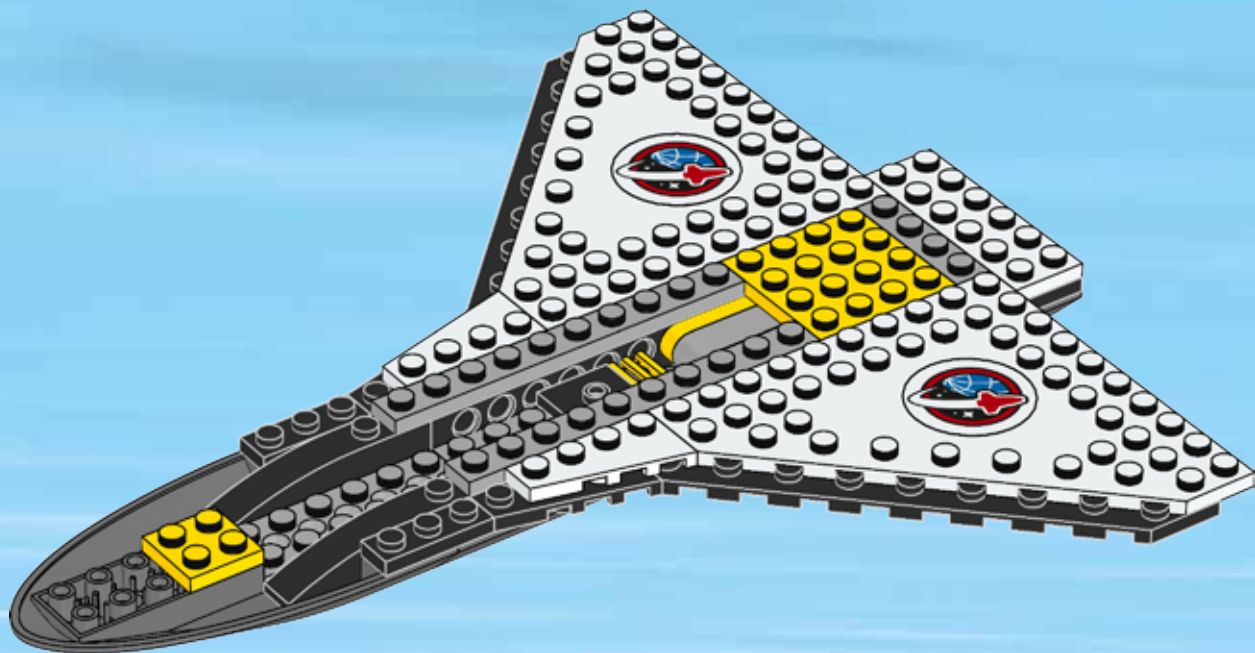



2x

# 25

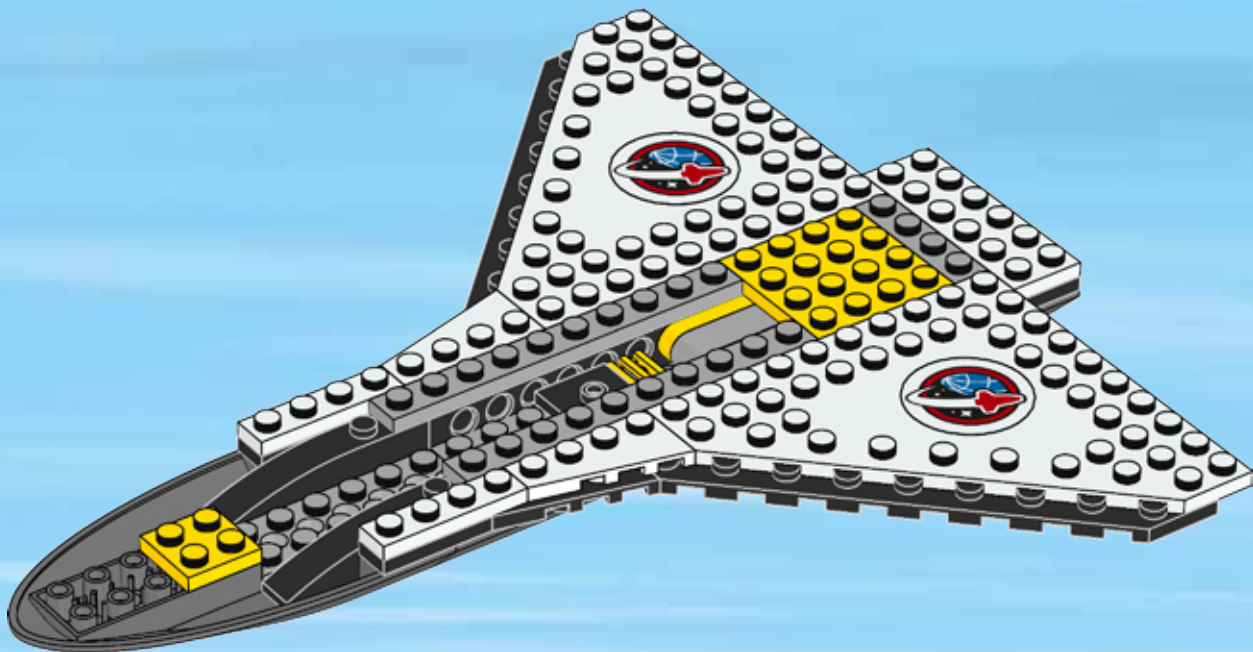

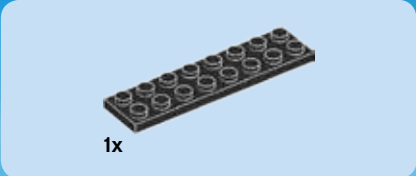

26

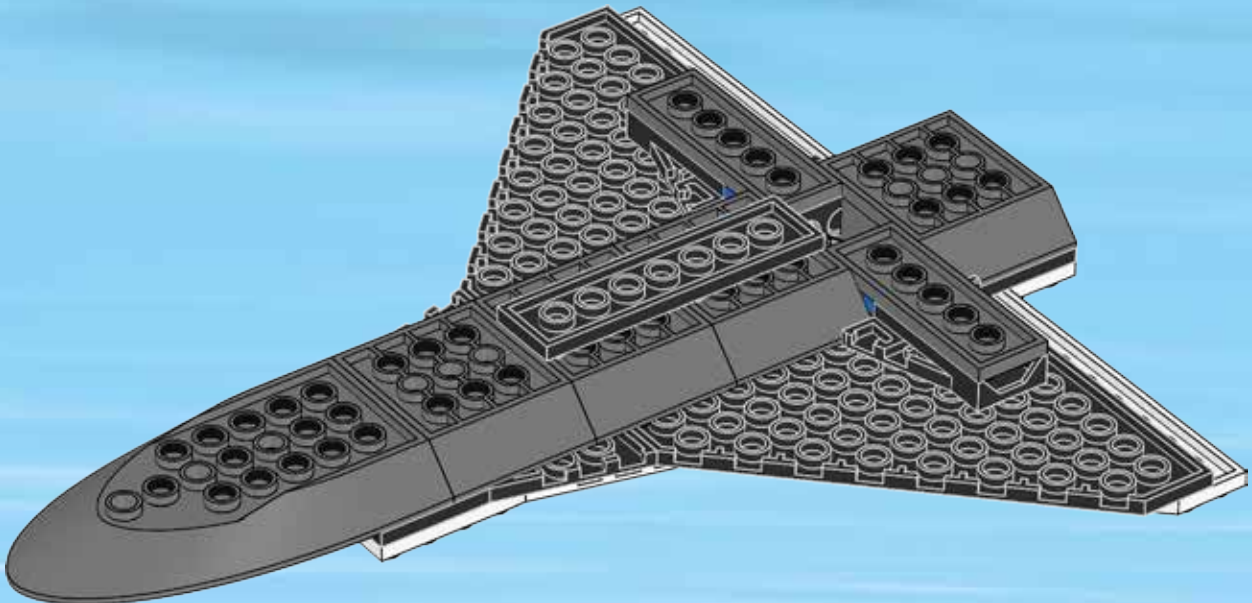

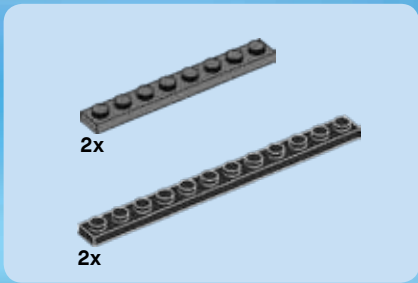

27

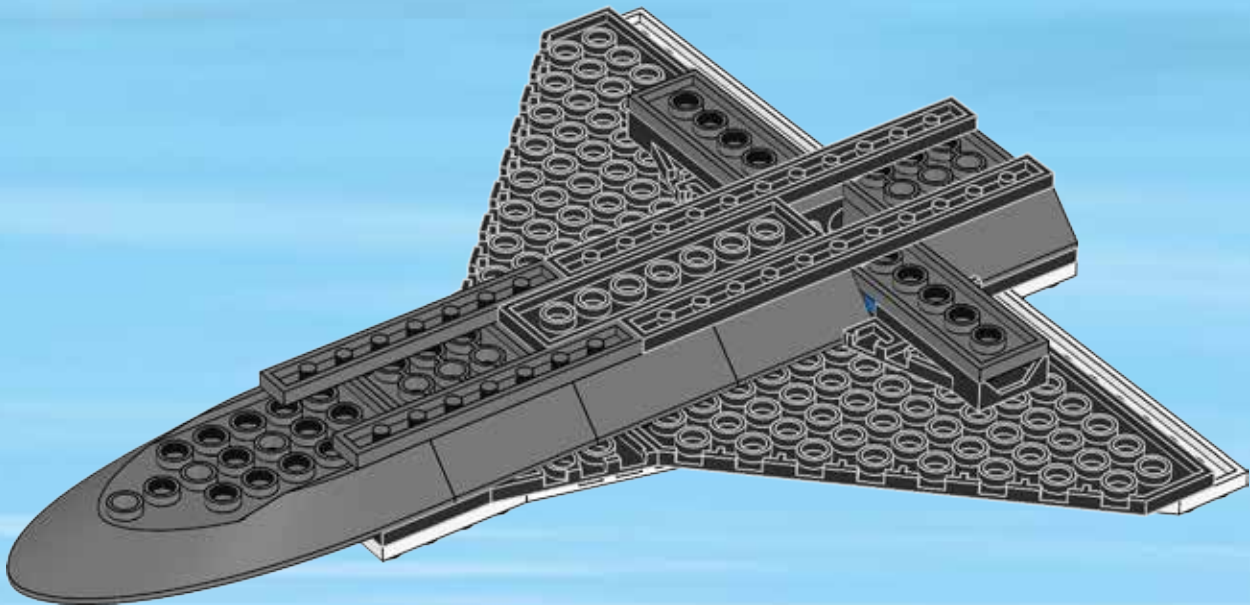

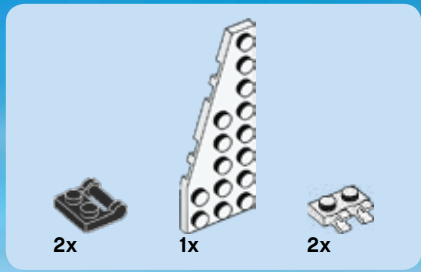

# 28

1

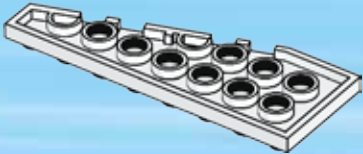

2

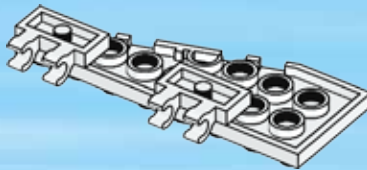

3

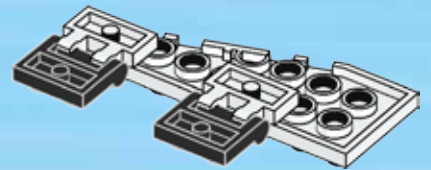



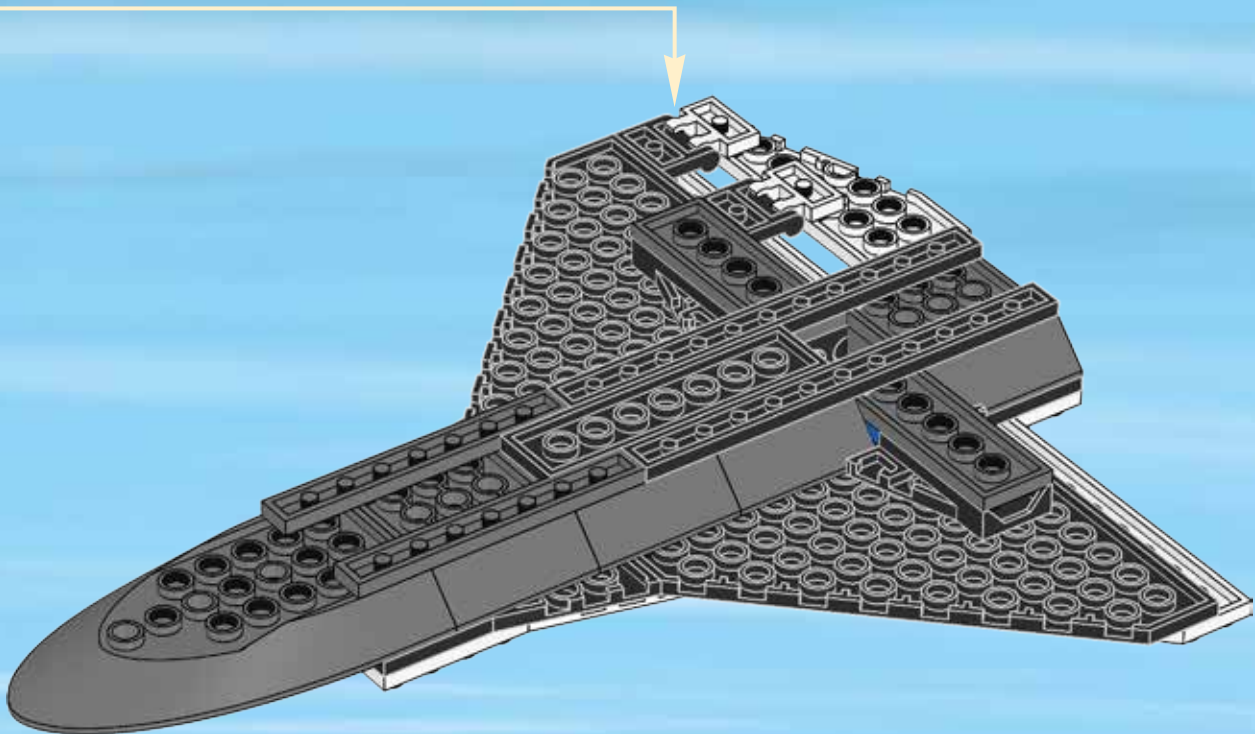

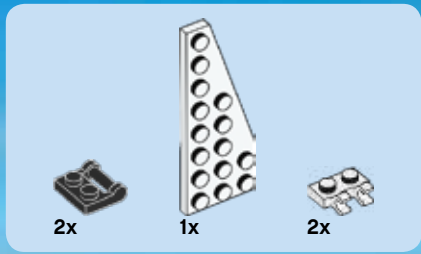

# 29

1

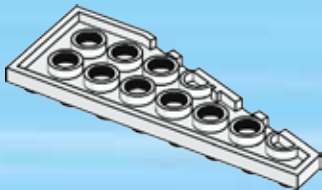

2

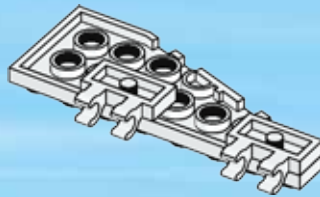

3

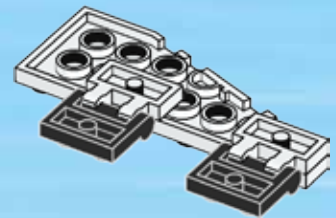

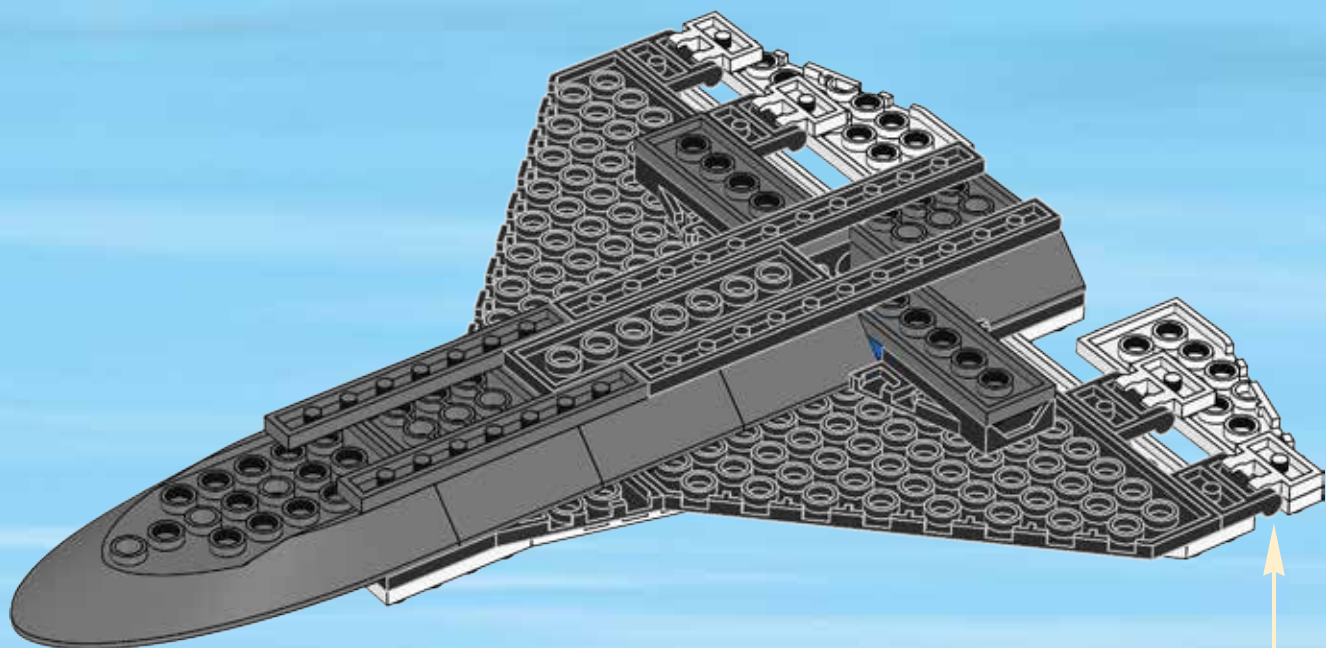



2x



1x

# 30

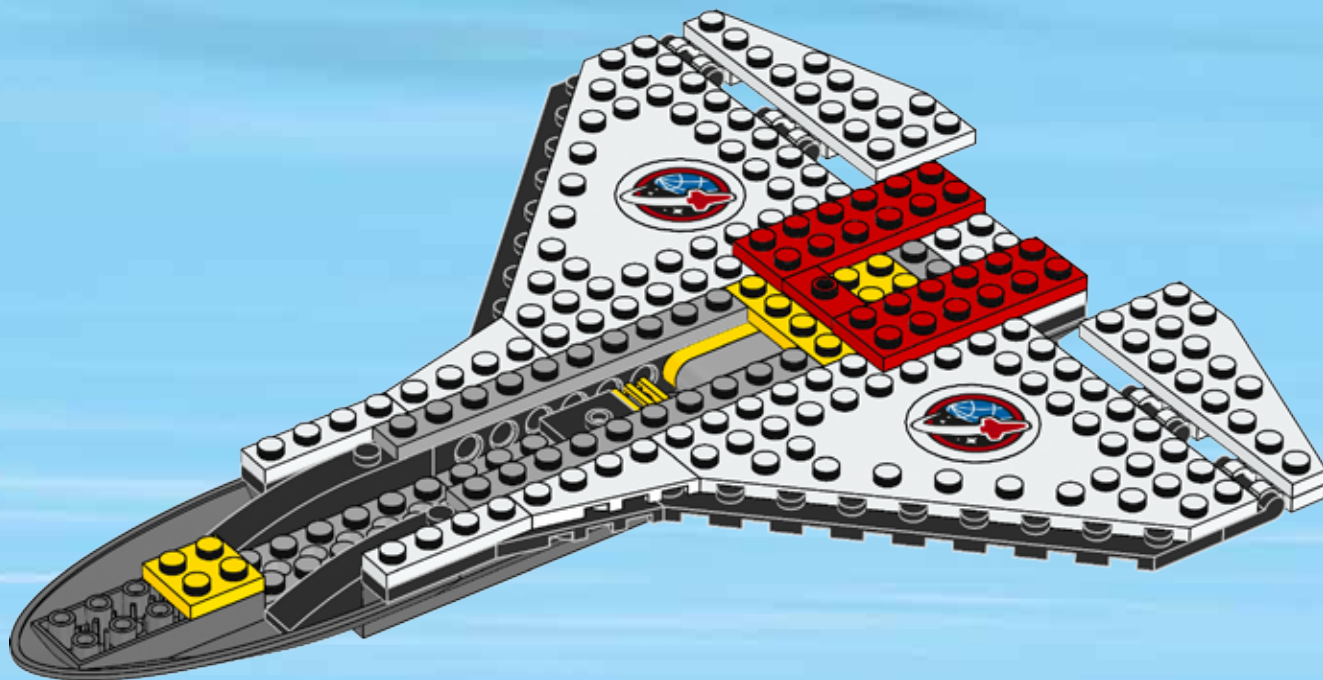



1x



1x

# 31

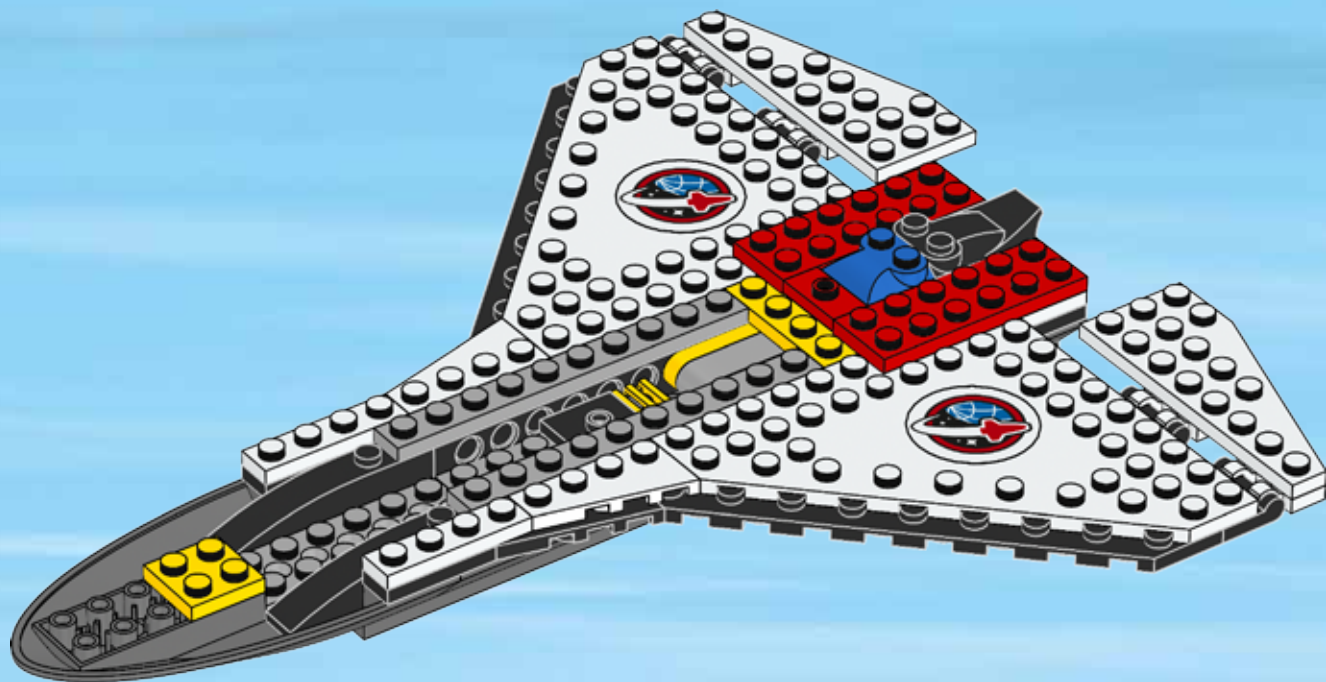



2x

# 32

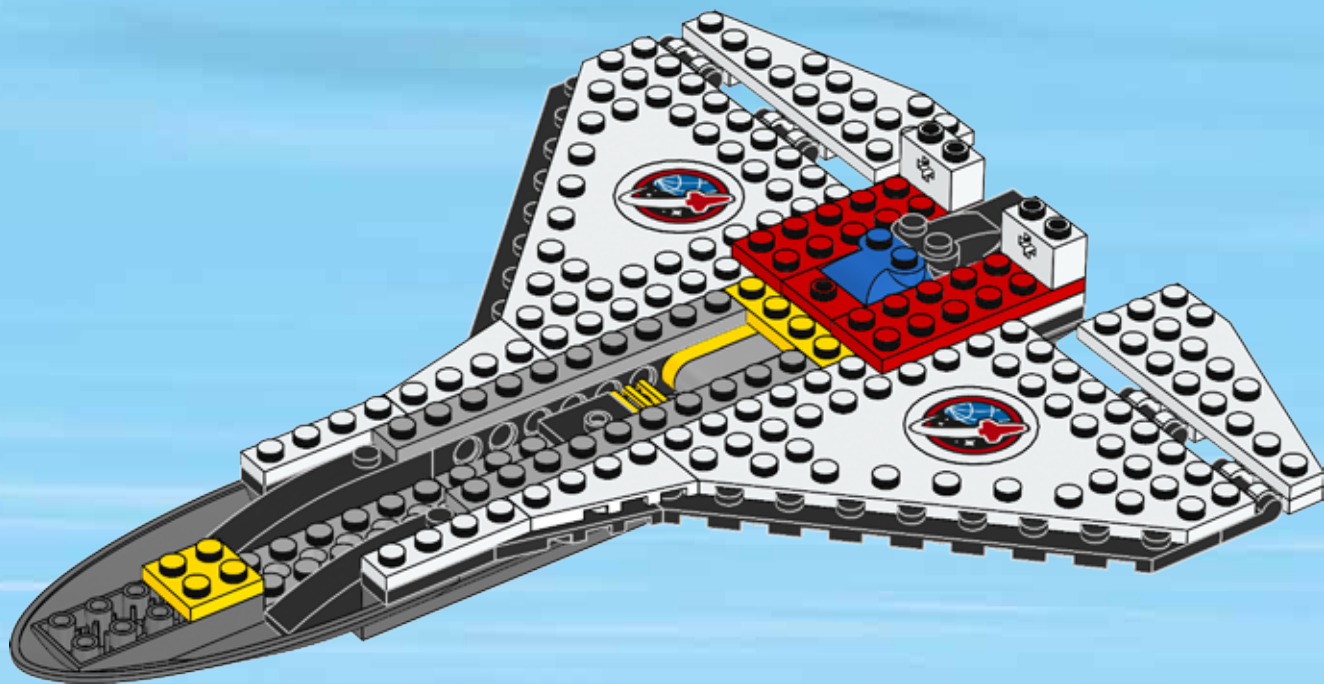



2x

# 33

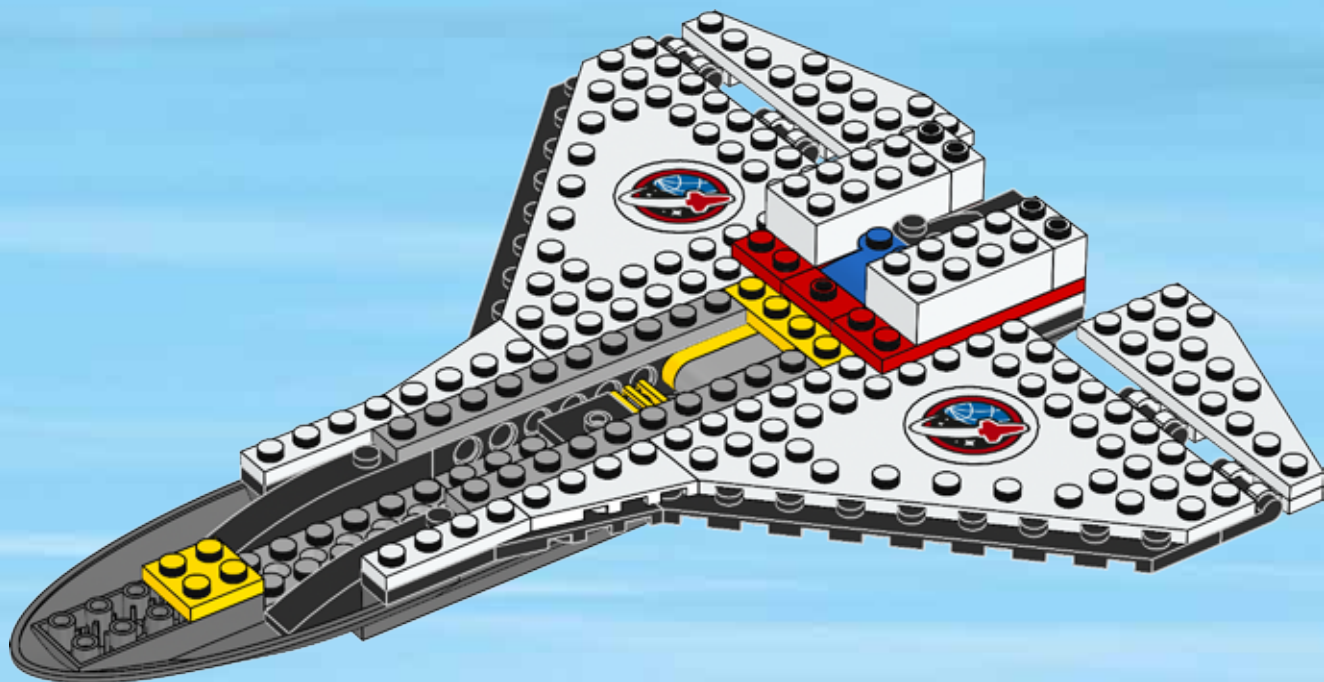



2x

# 34

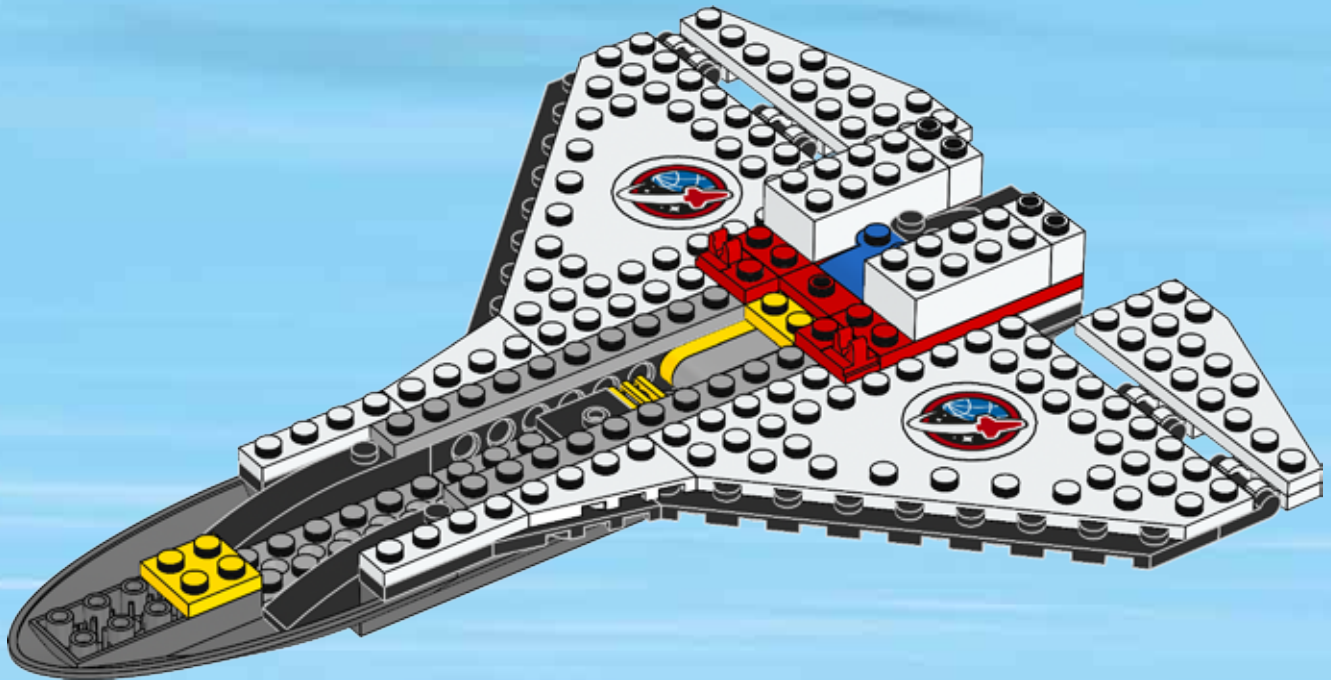





2x

# 35

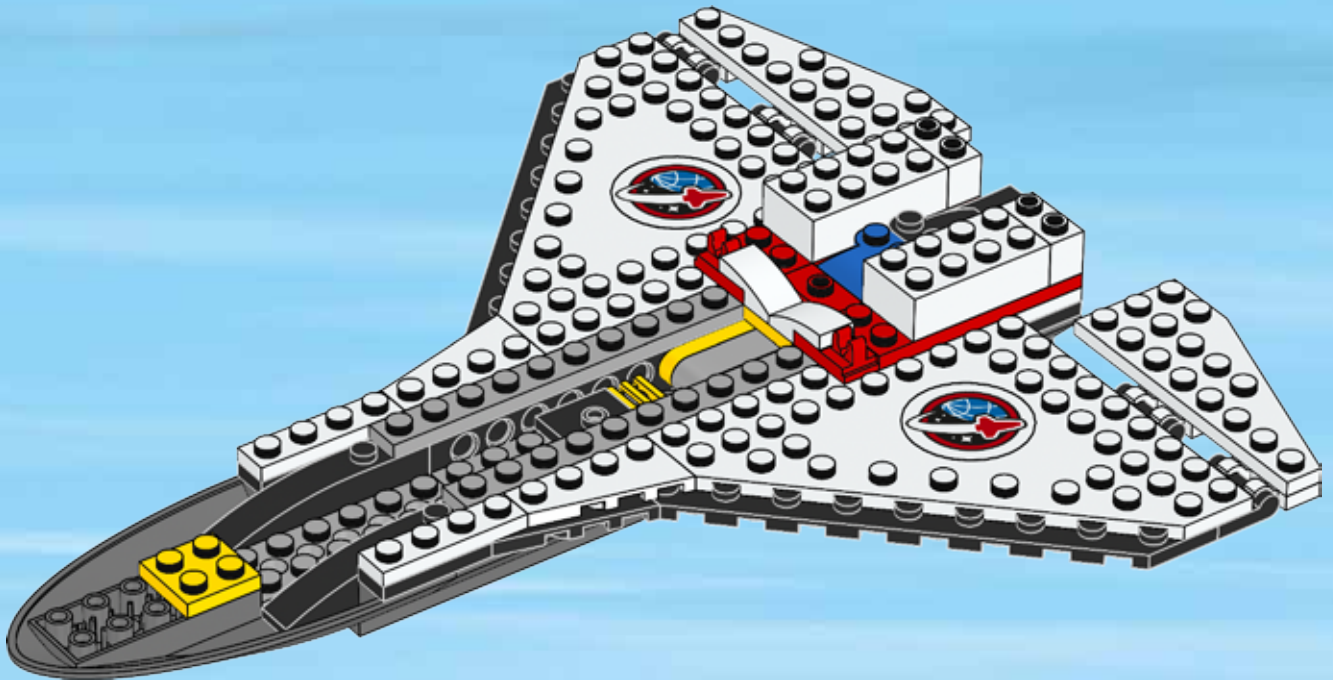



1x



2x

# 36

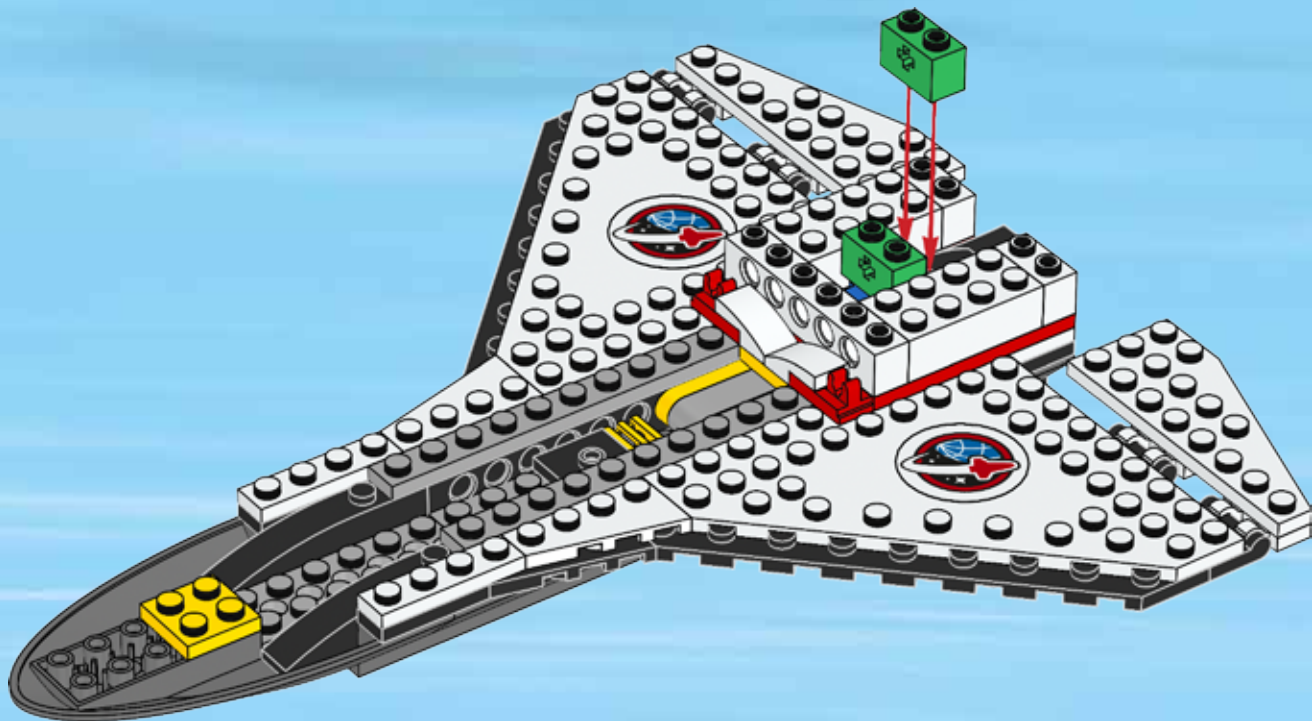



3x

# 37

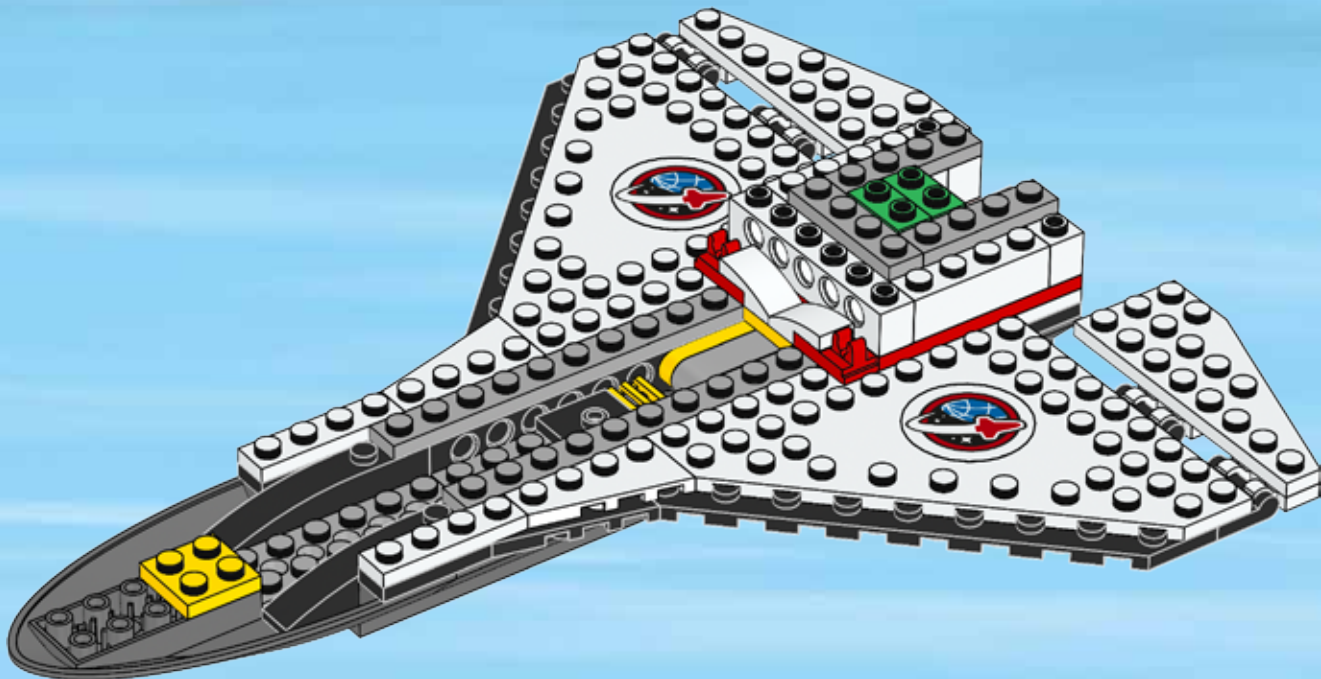

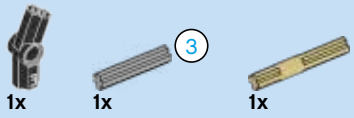

# 38

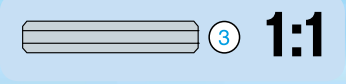
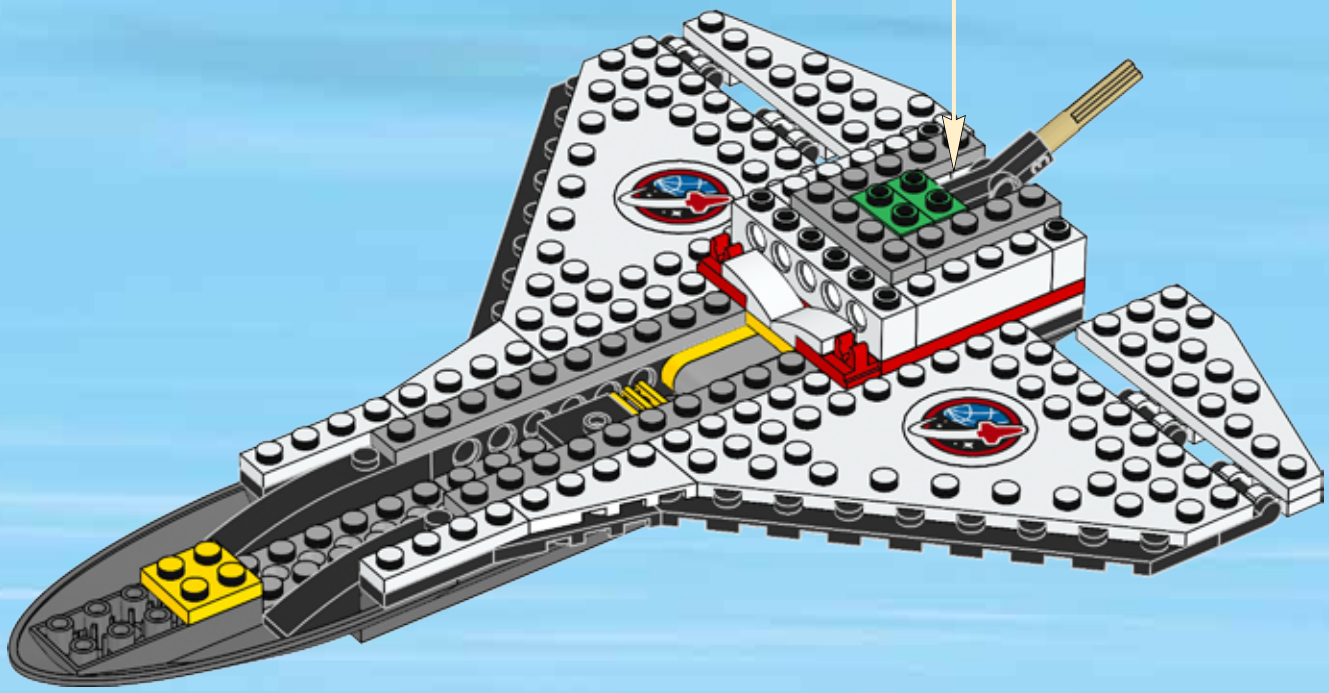
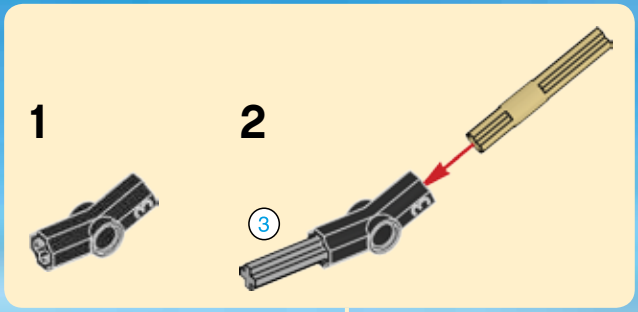



1x



1x

# 39

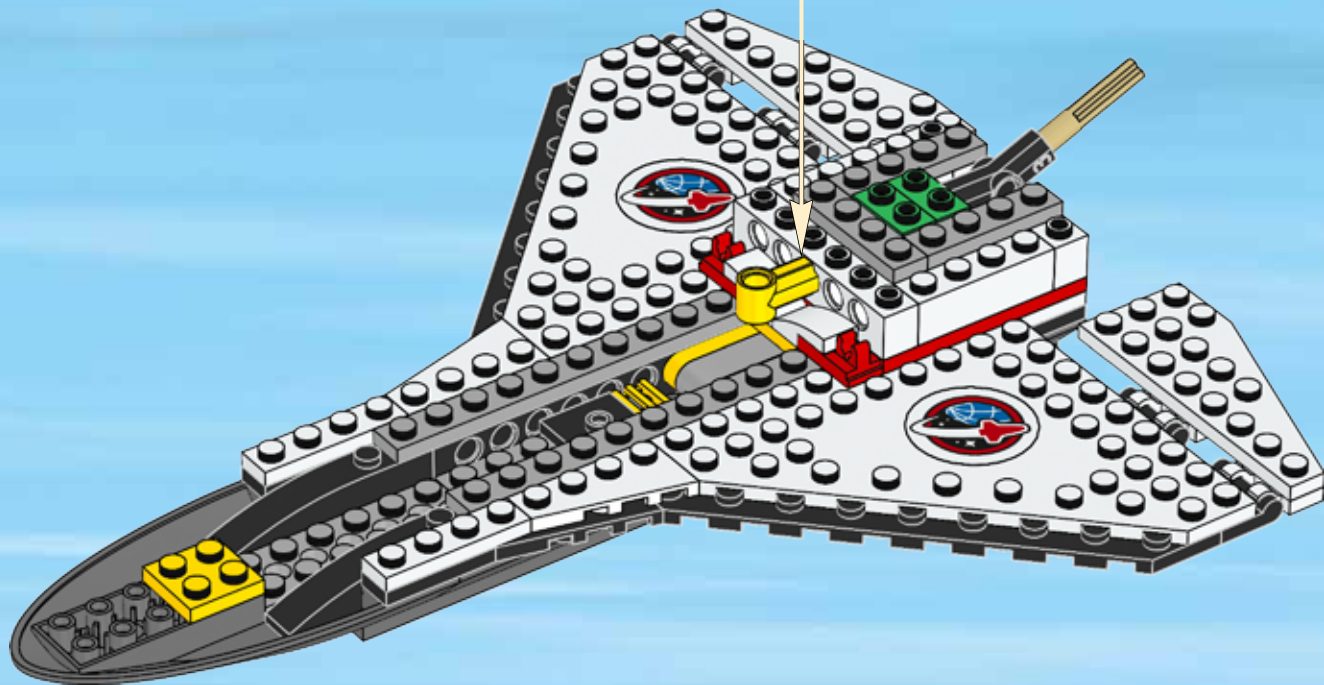
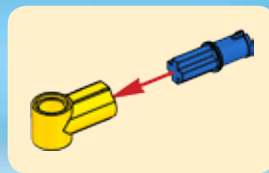



2x

# 40

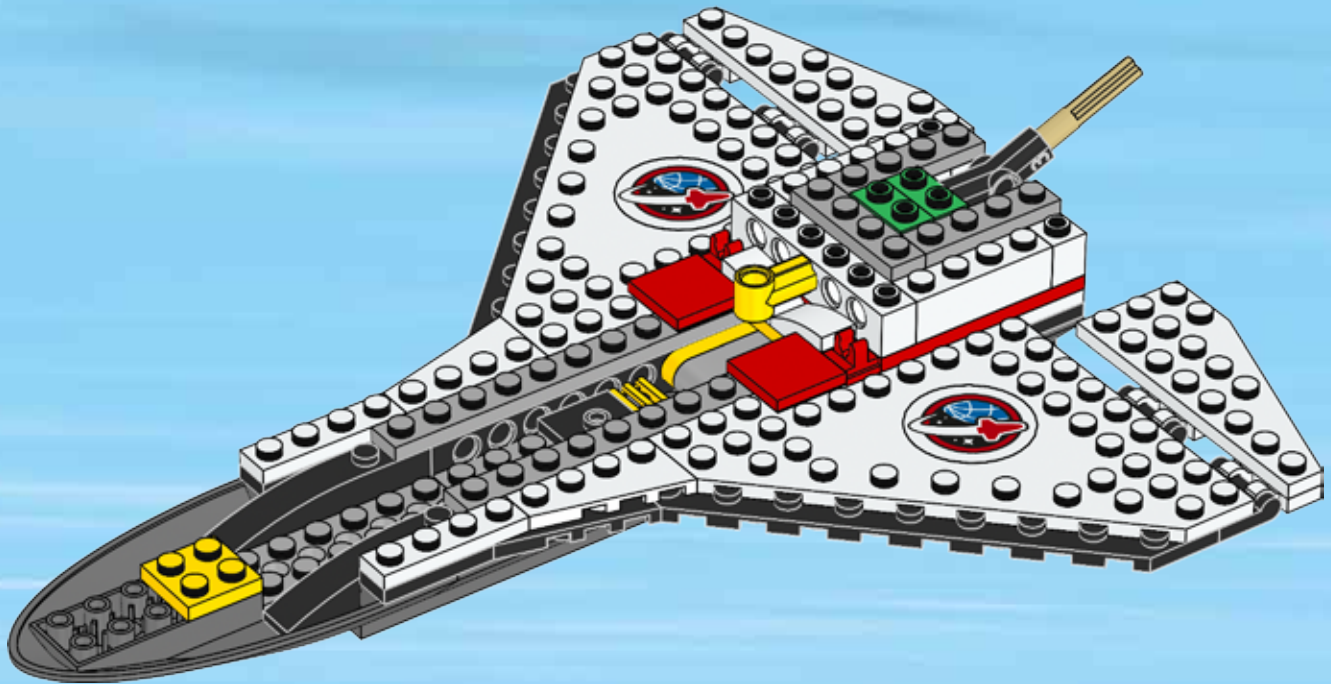



4x

41

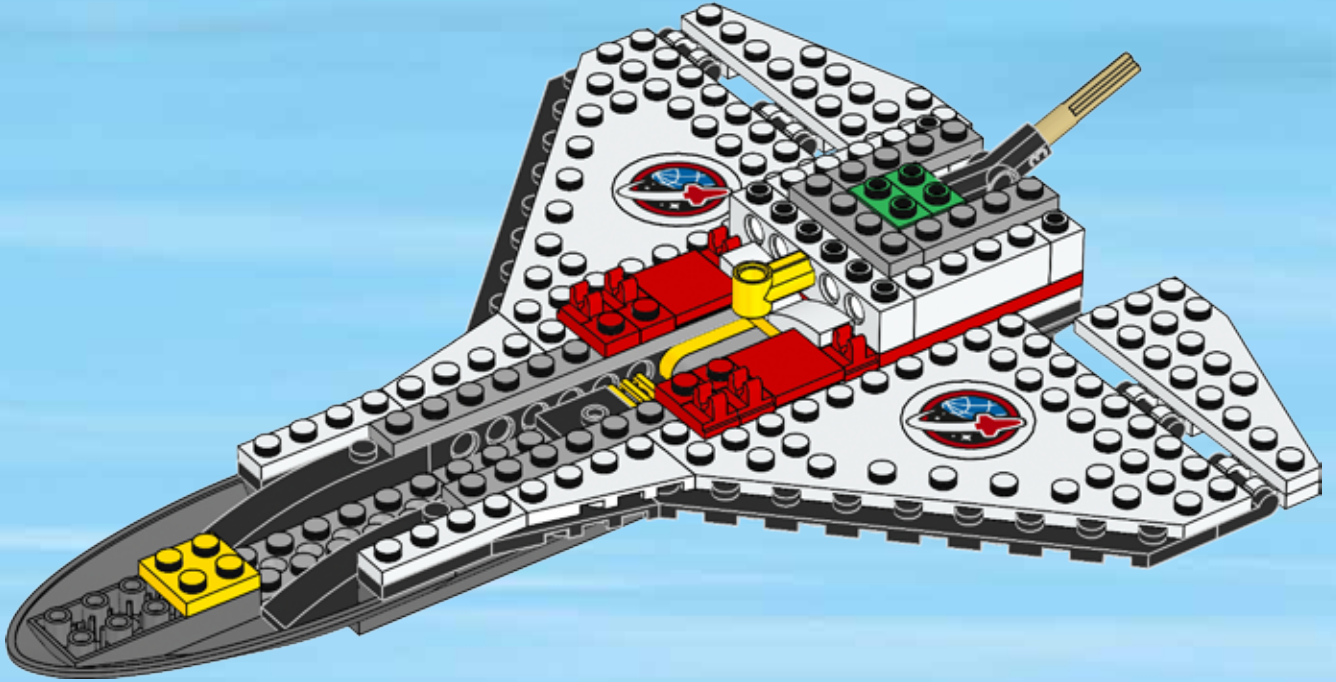



2x

42

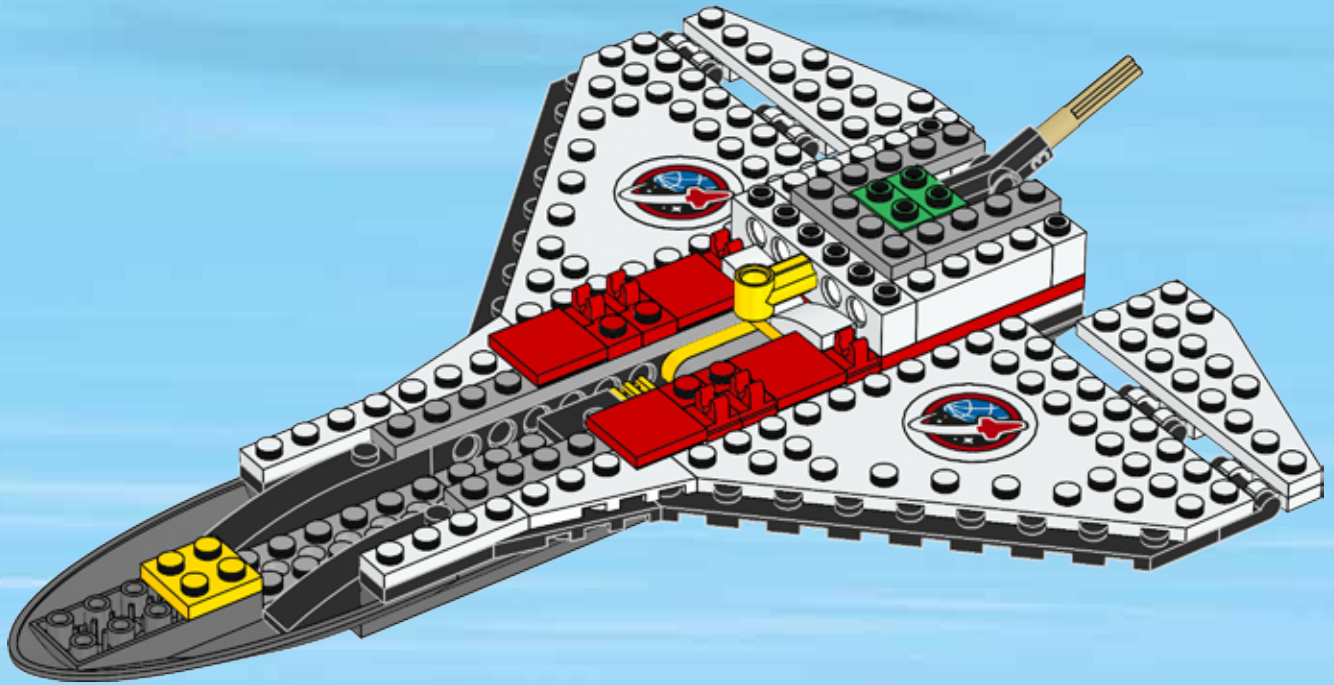





4x



2x

# 43

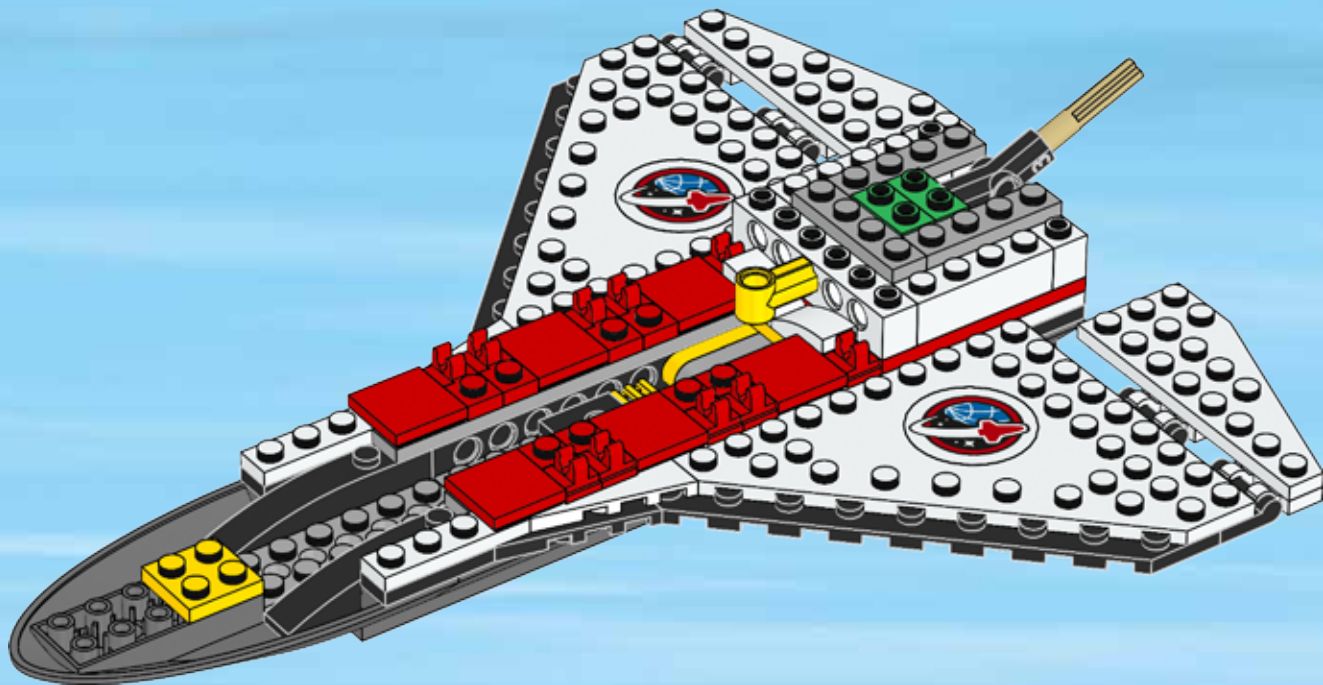



1x



2x



2x

# 44

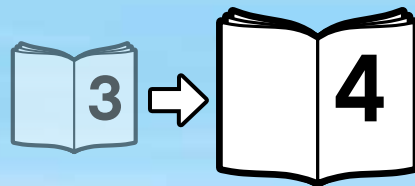
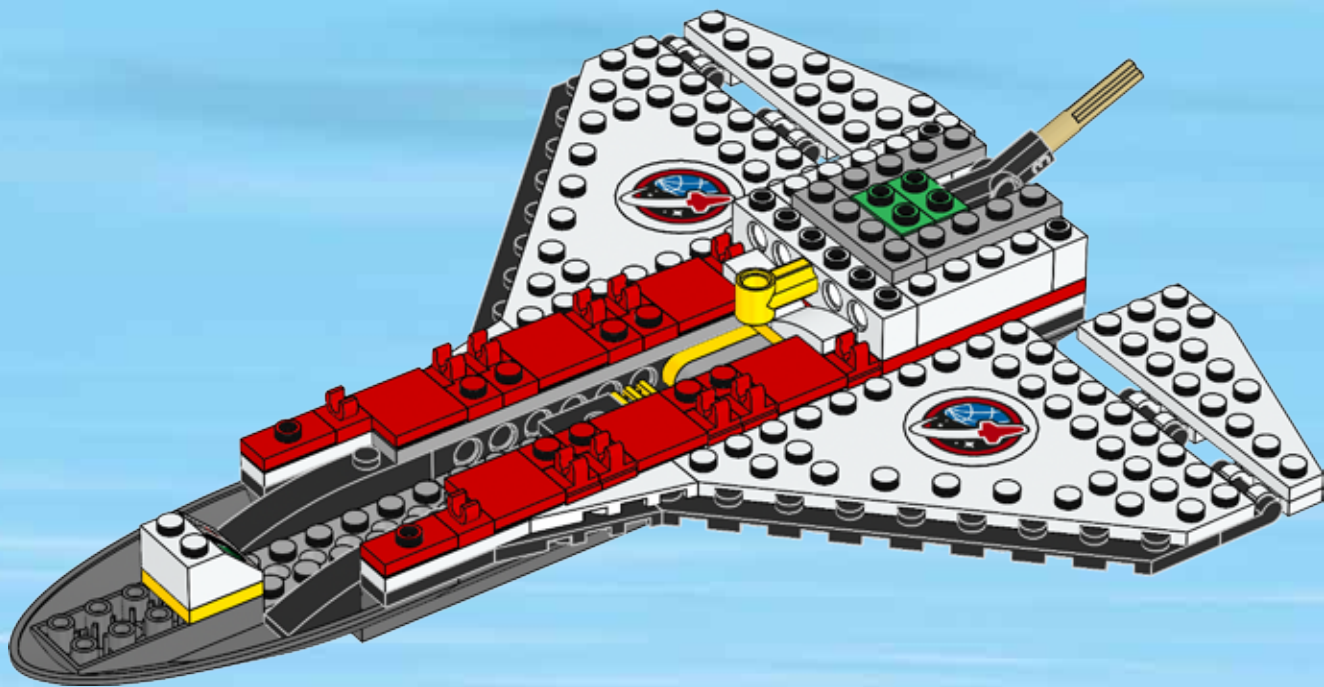



# CITY

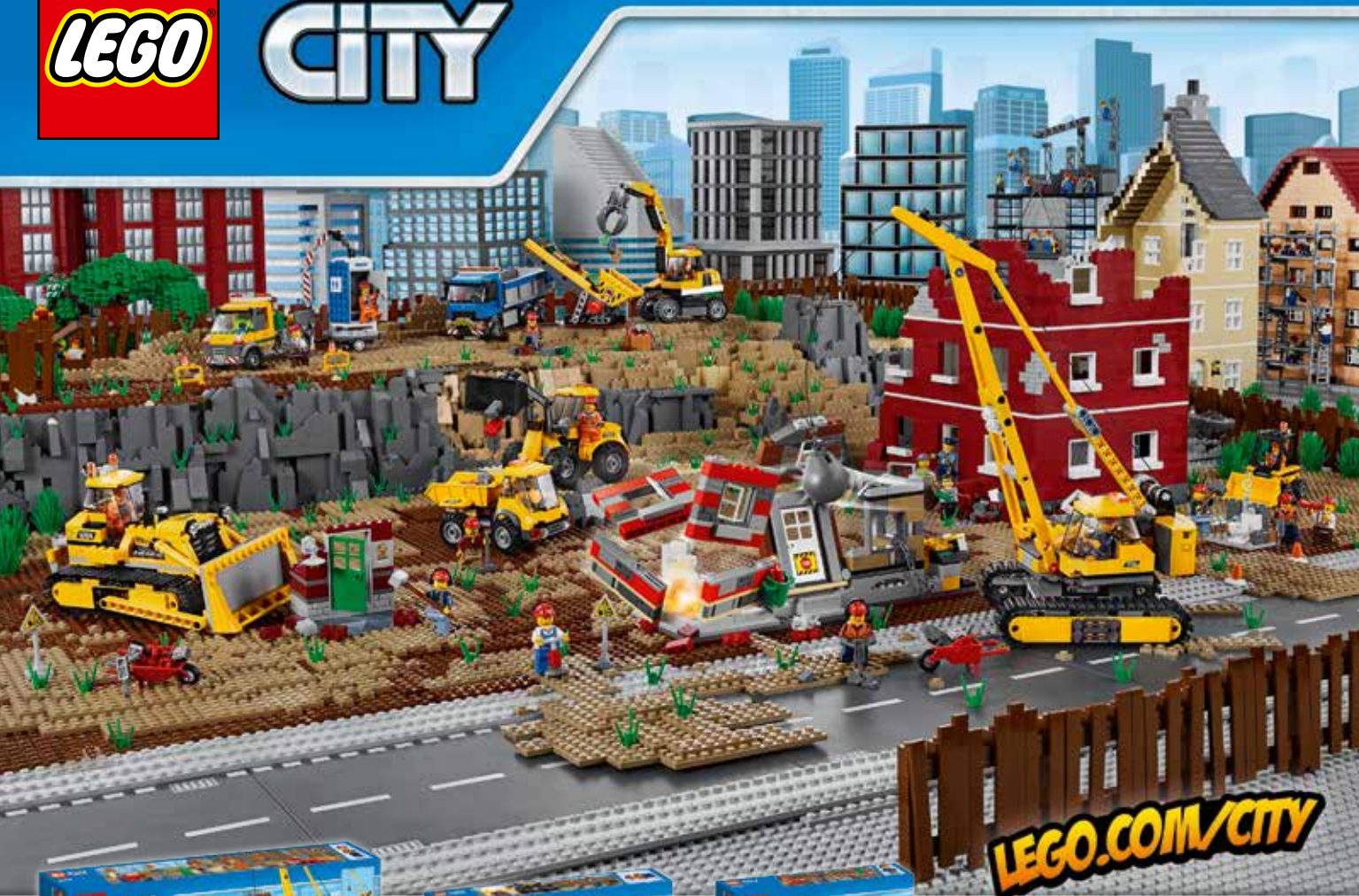

[LEGO.COM/CITY](http://LEGO.COM/CITY)



60076



60075



60074



60073



60072



# CITY

