

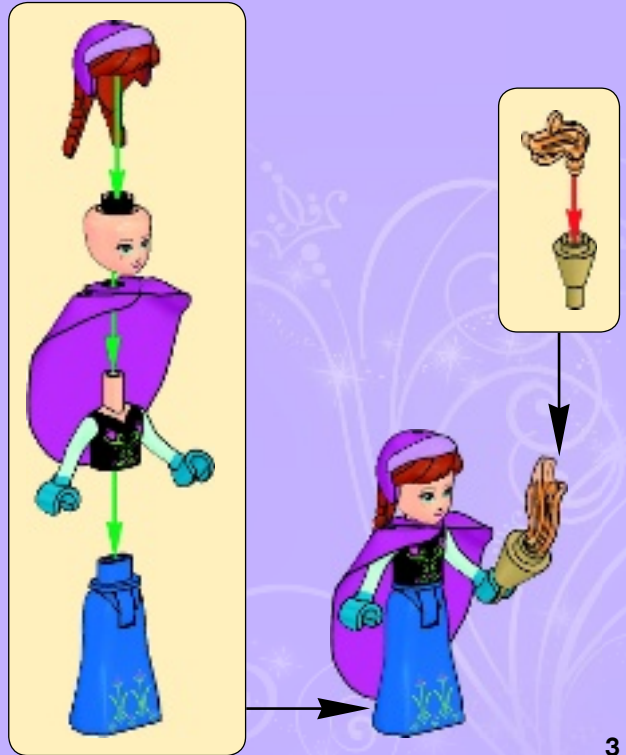

41062

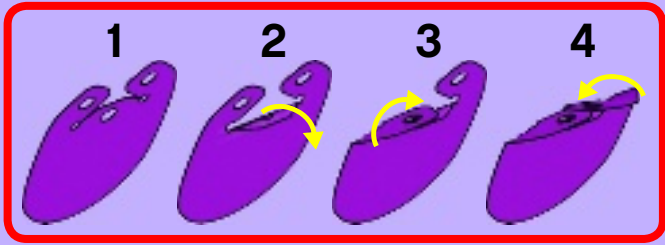

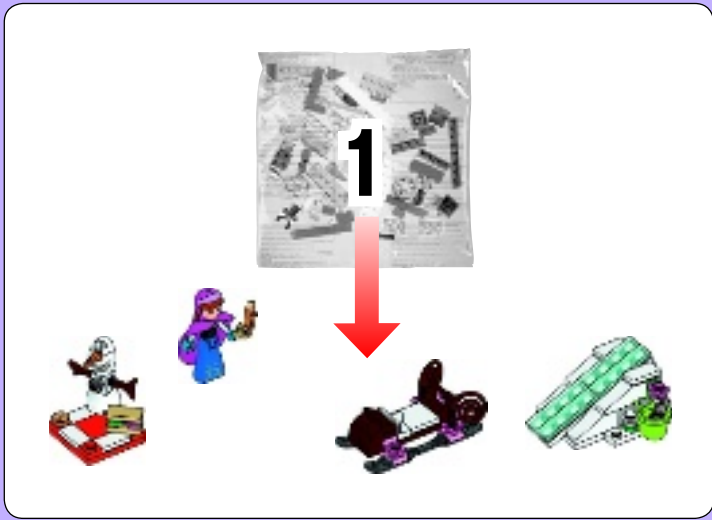



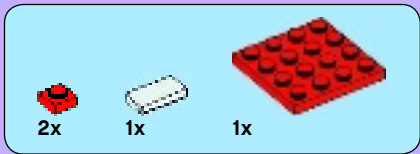

1

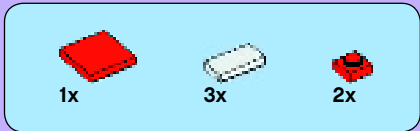
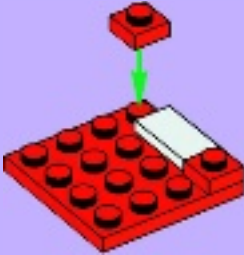

2



3

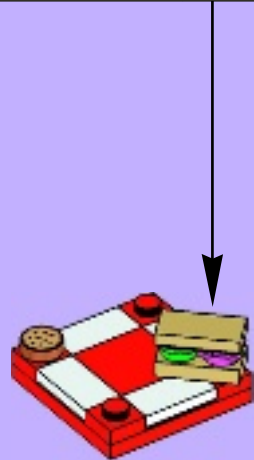
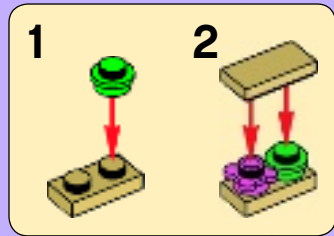

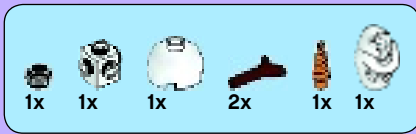

# 4

1

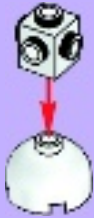

2



3



4



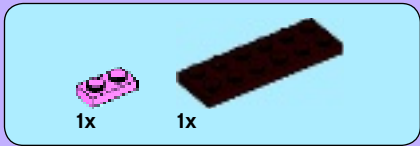

1

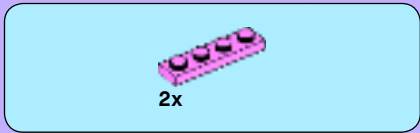
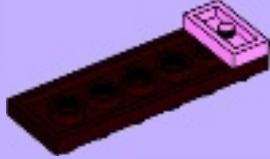

2

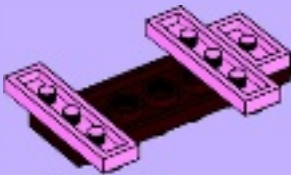

3

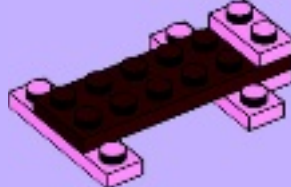
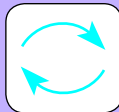

4

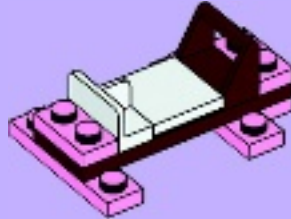



1x

2x

5

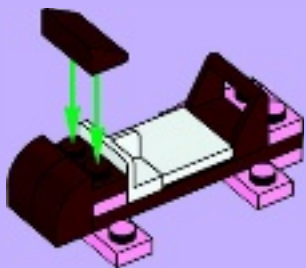

4x

6

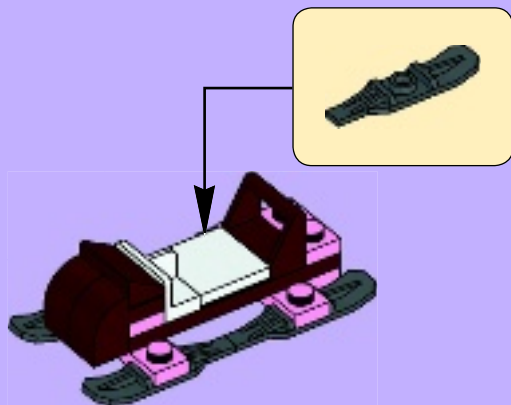

4x

7

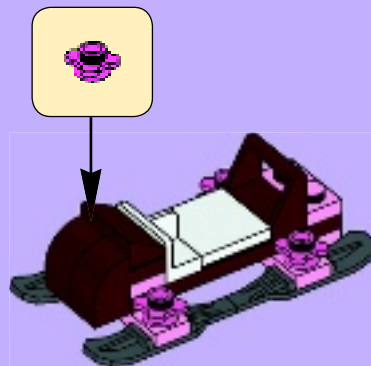

2x

8

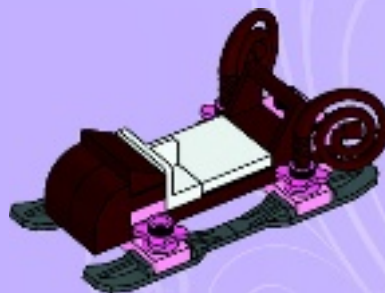

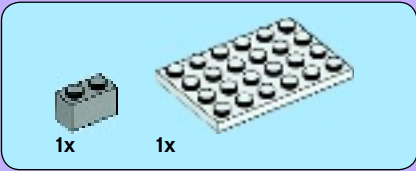

1



2

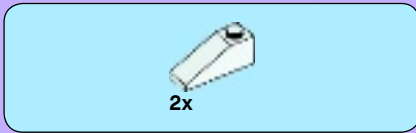

3

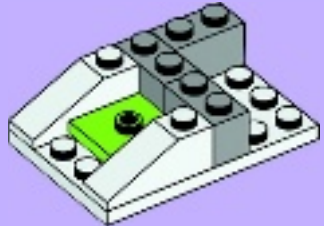





1x

4

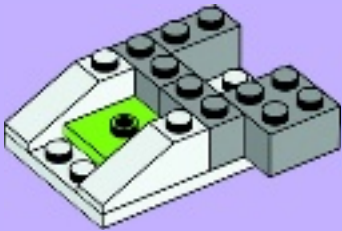

1x

5



1x



1x



2x

6

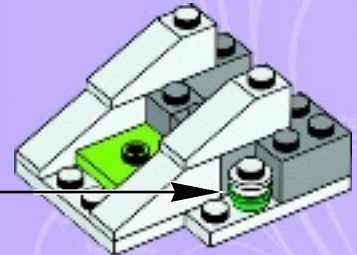
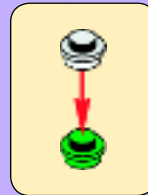



# 7

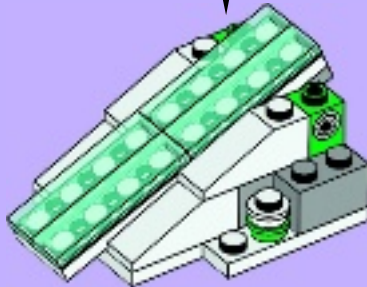
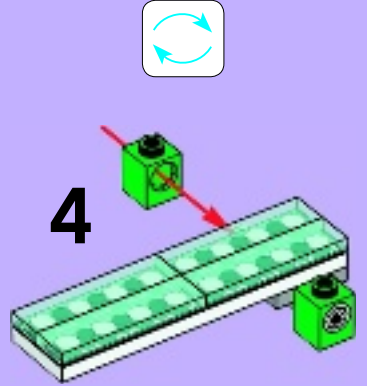
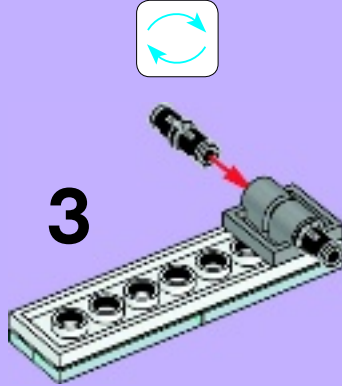
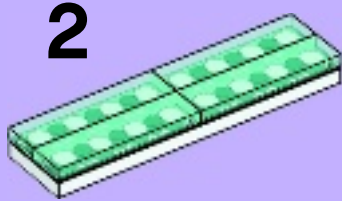
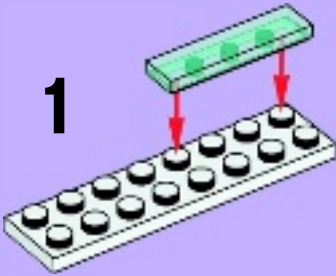

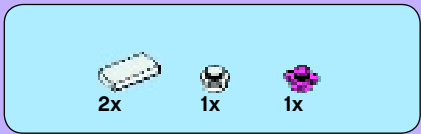

8

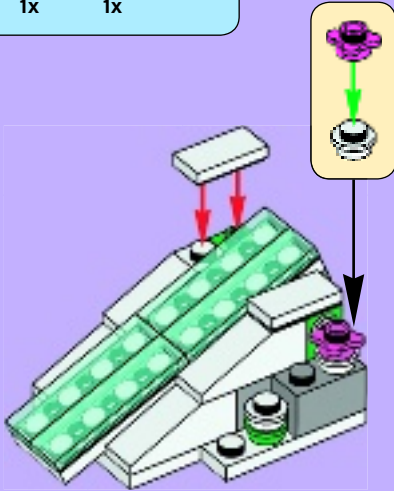

9

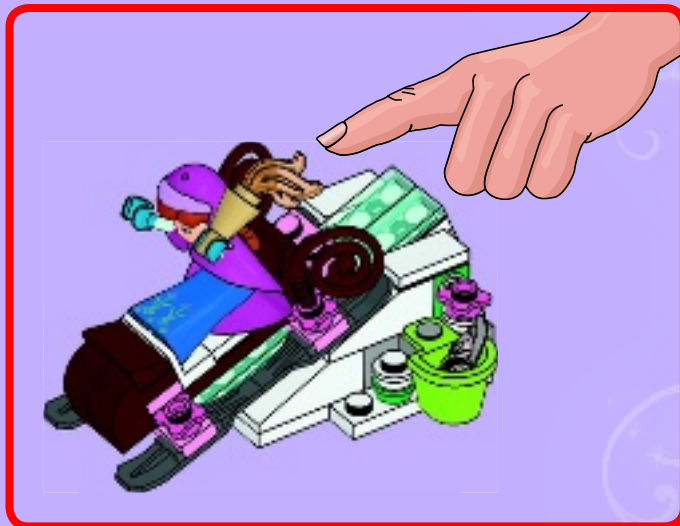
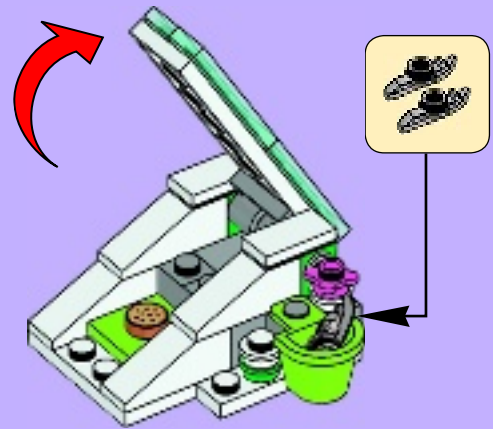

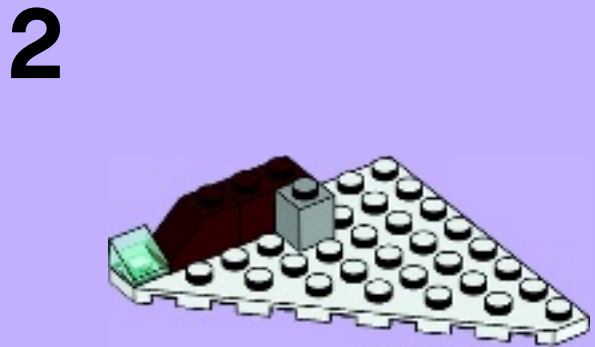
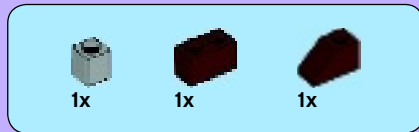
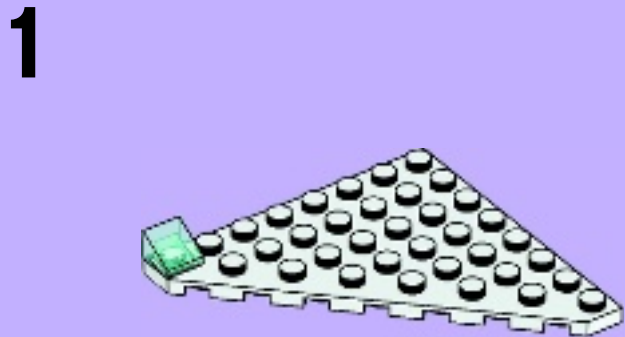
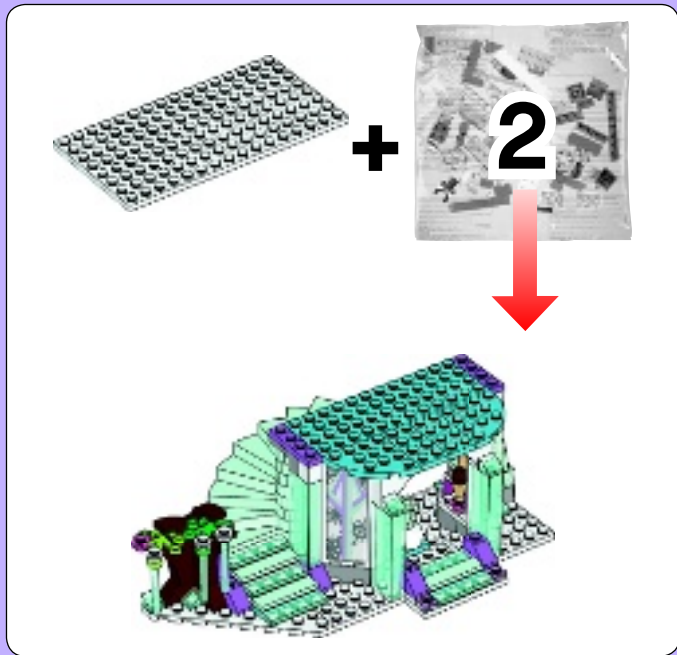

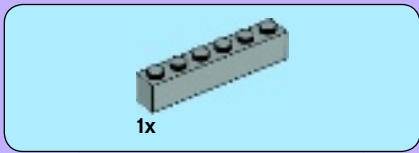

4

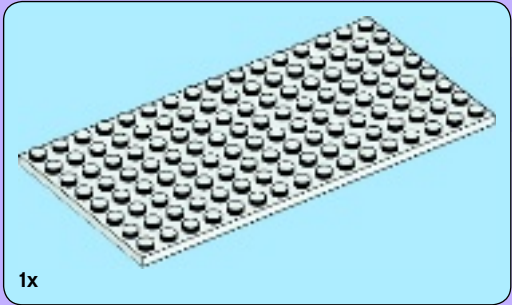
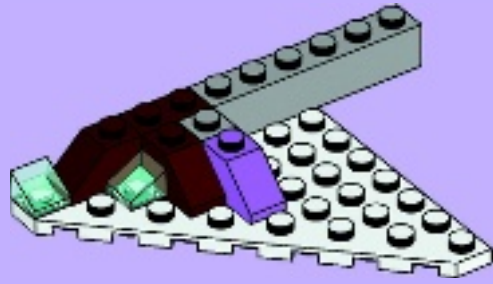

5

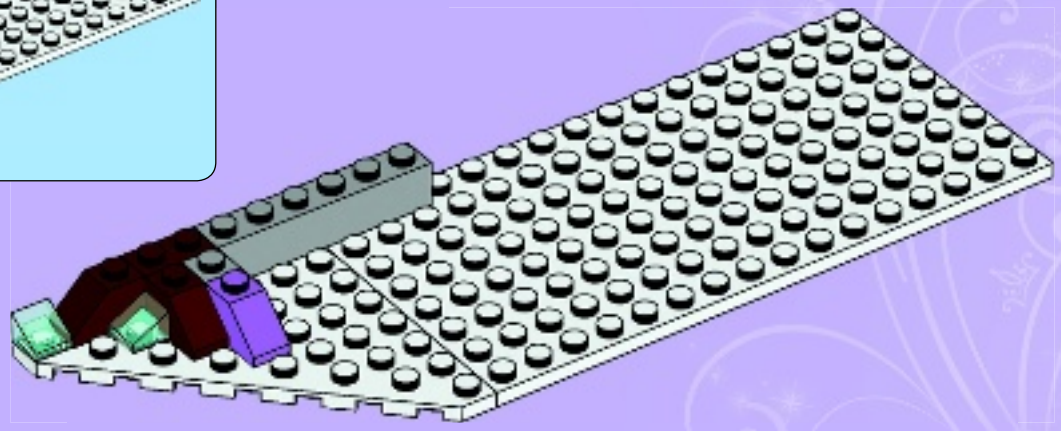



1x



1x

# 6

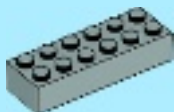
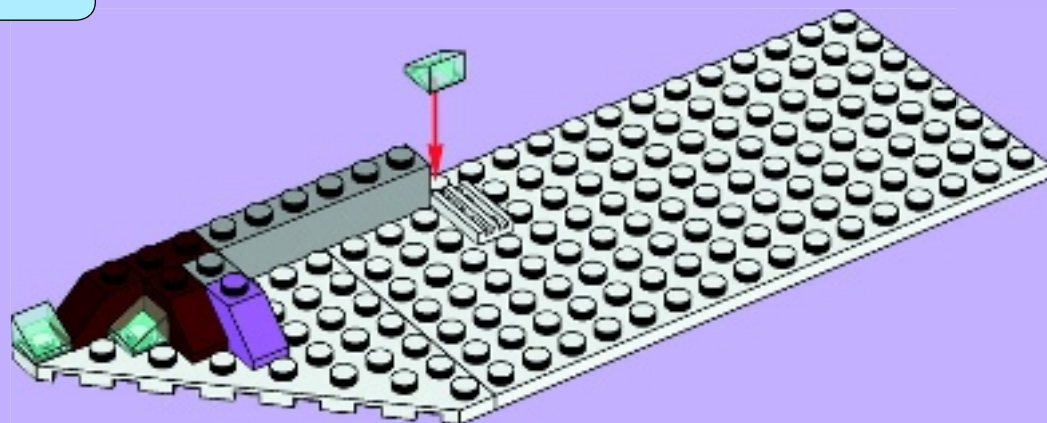

1x

# 7

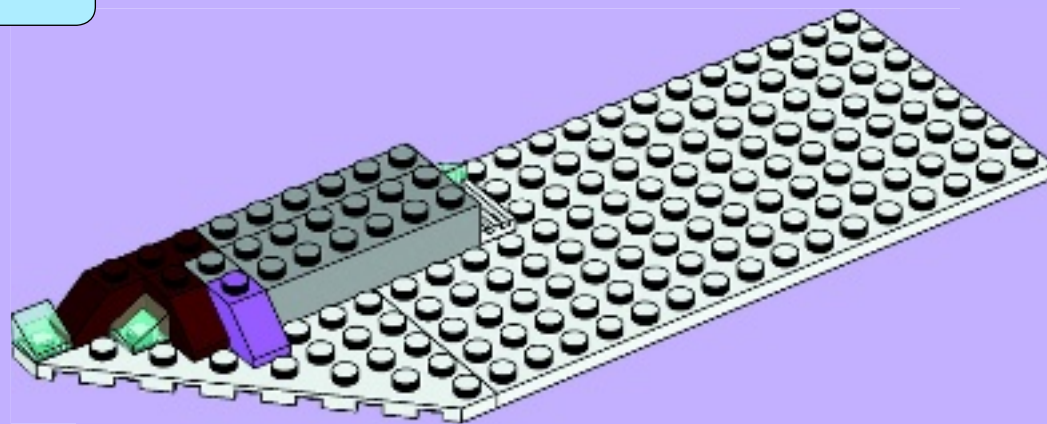



8

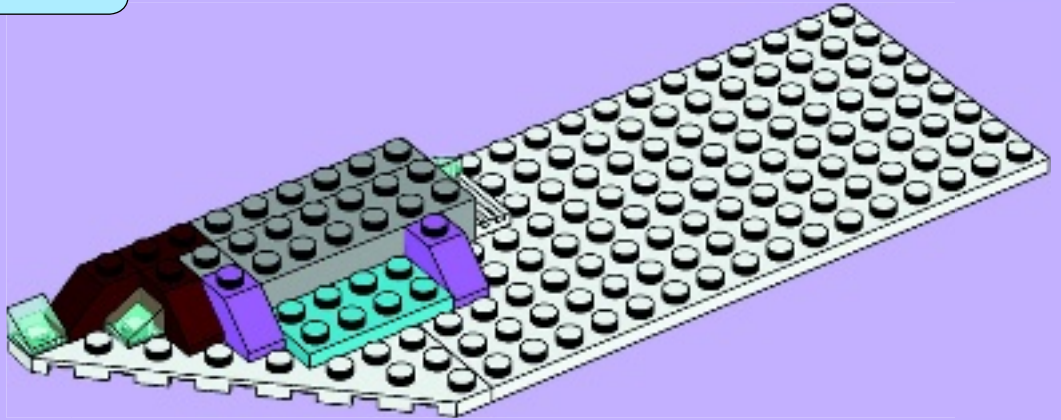

9

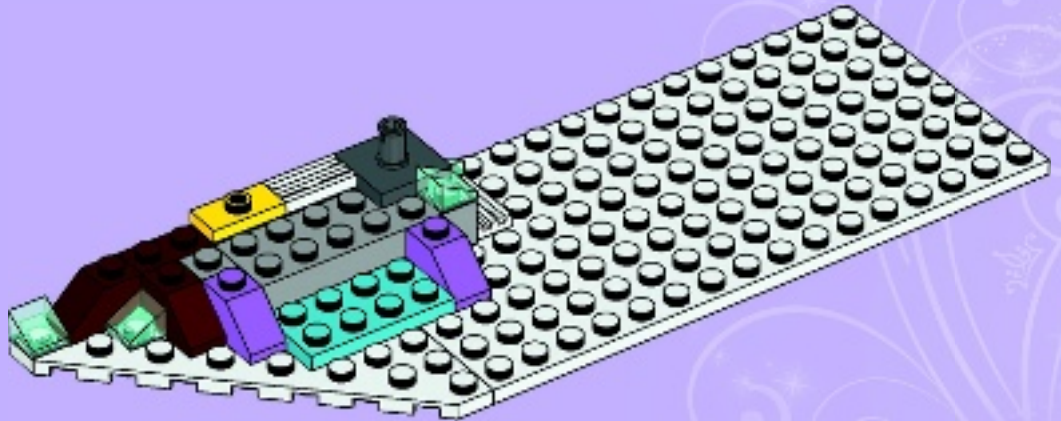

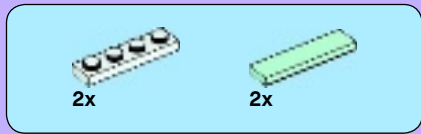

10

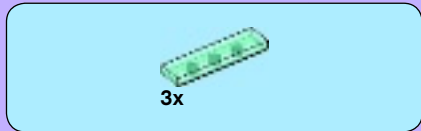
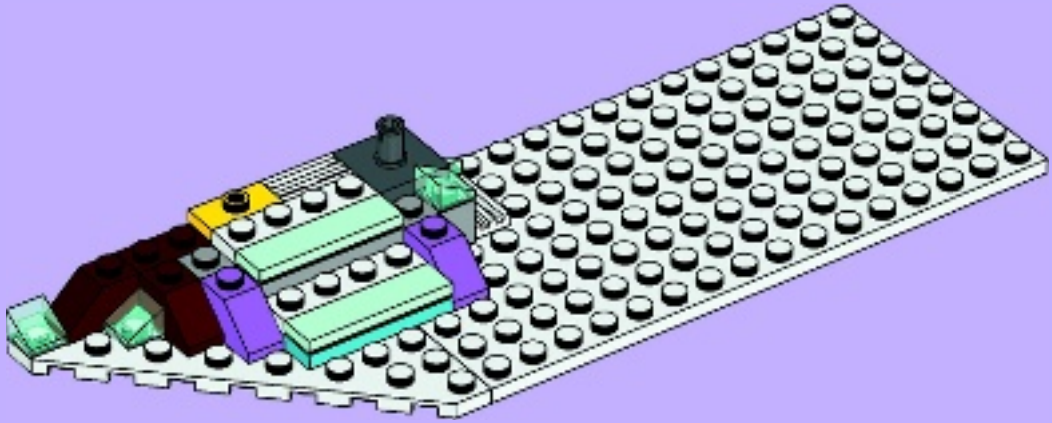

11

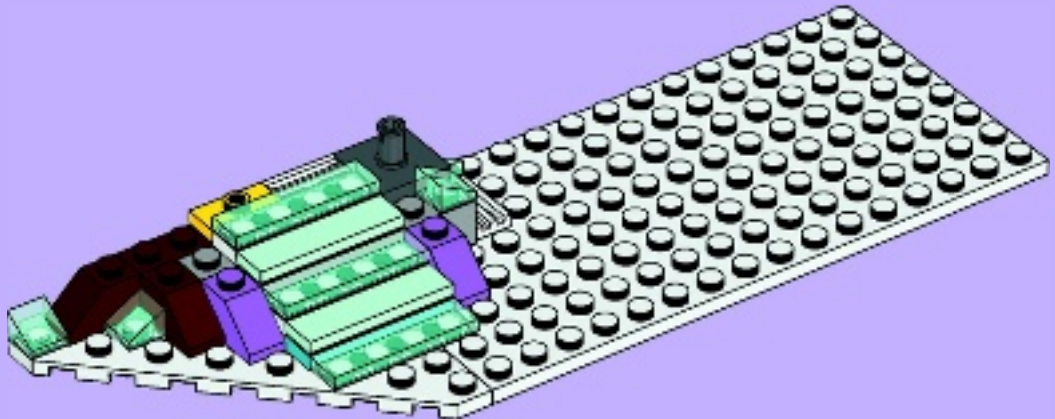





1x



1x

# 12

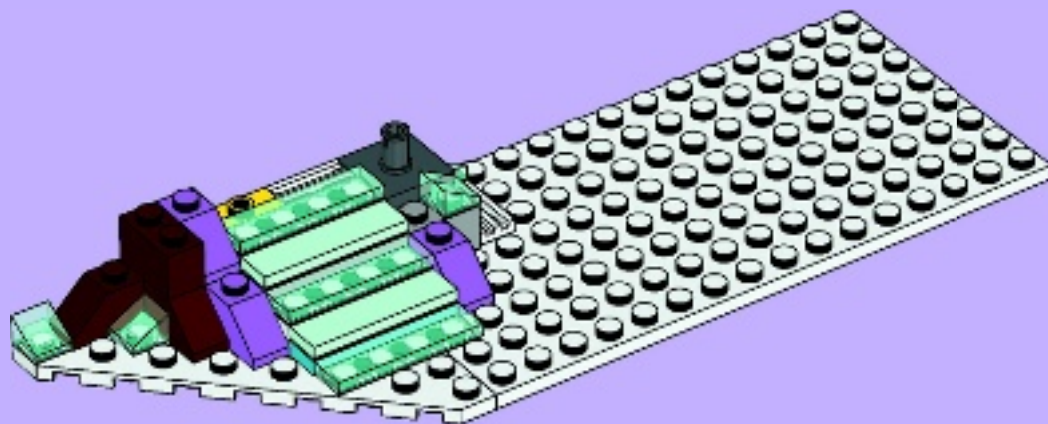

1x



2x

# 13

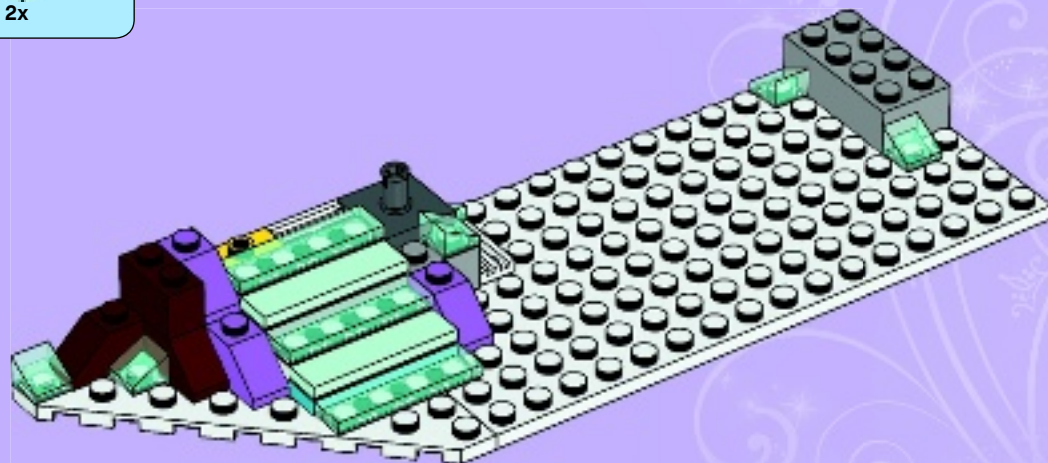



1x



2x

# 14

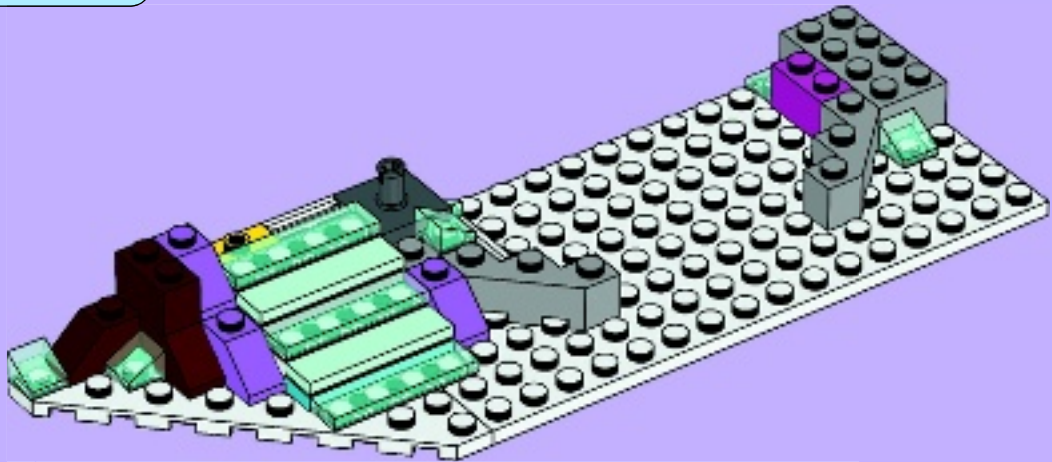

2x

# 15

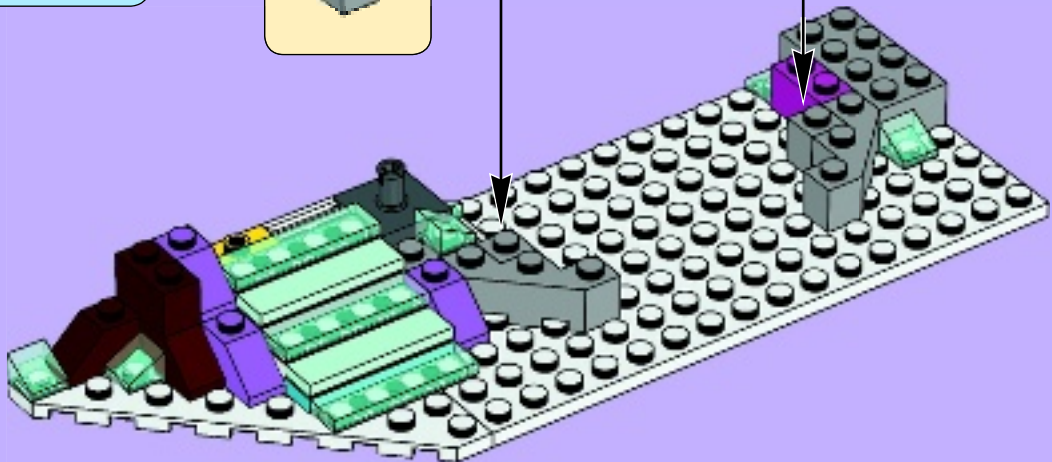
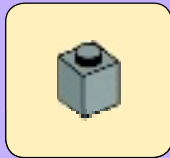



2x



1x

# 16

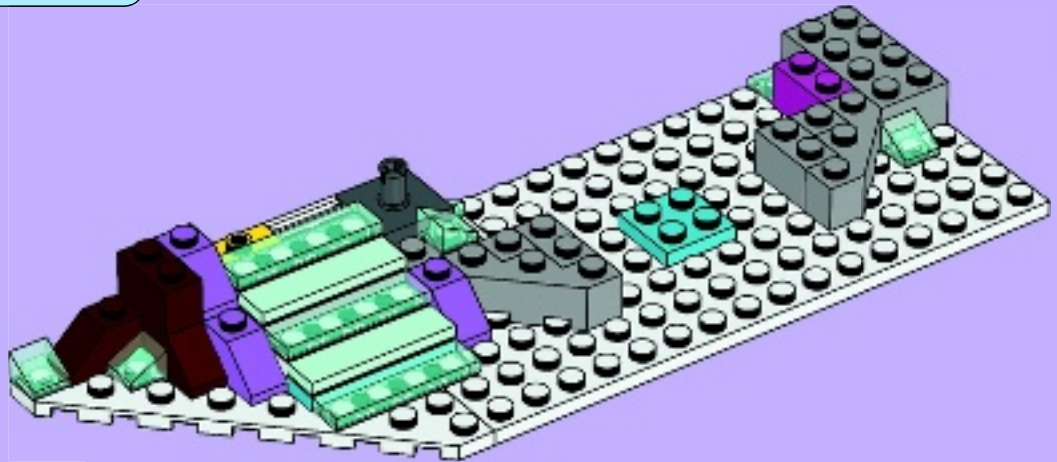

2x

# 17





1x



1x

# 18

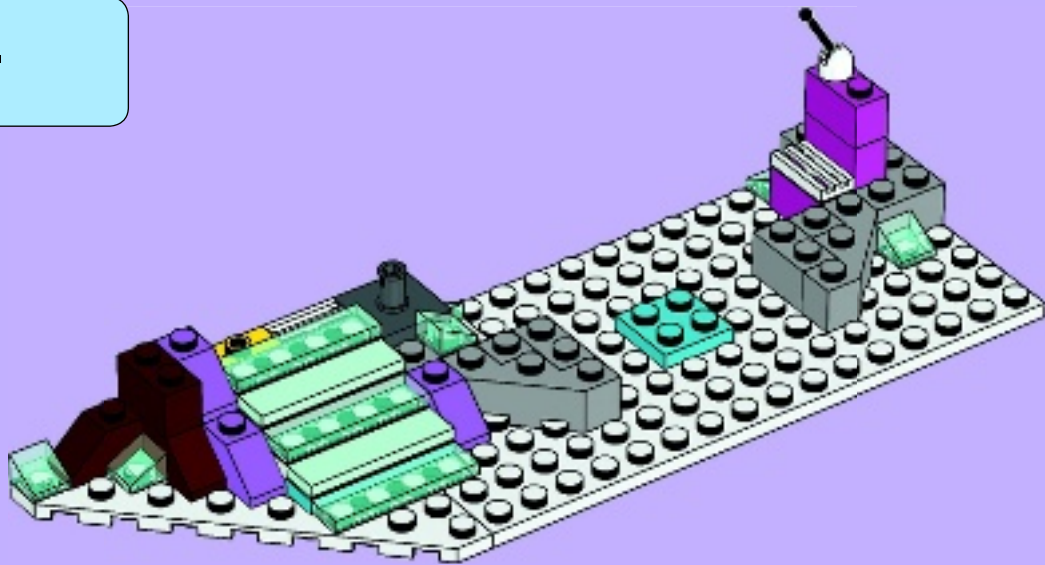

2x



1x

# 19

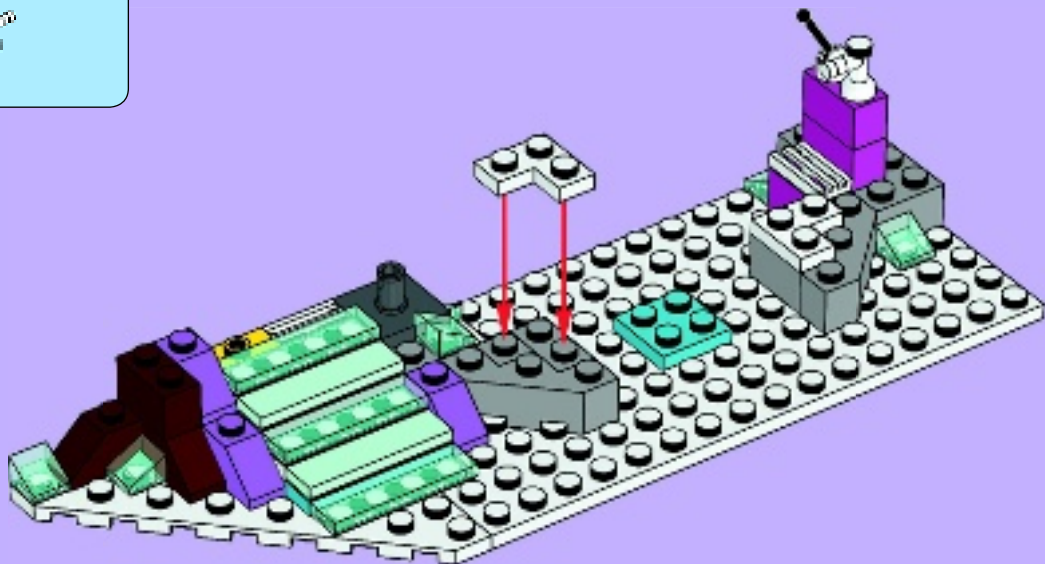

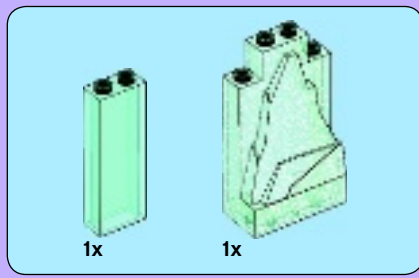

20

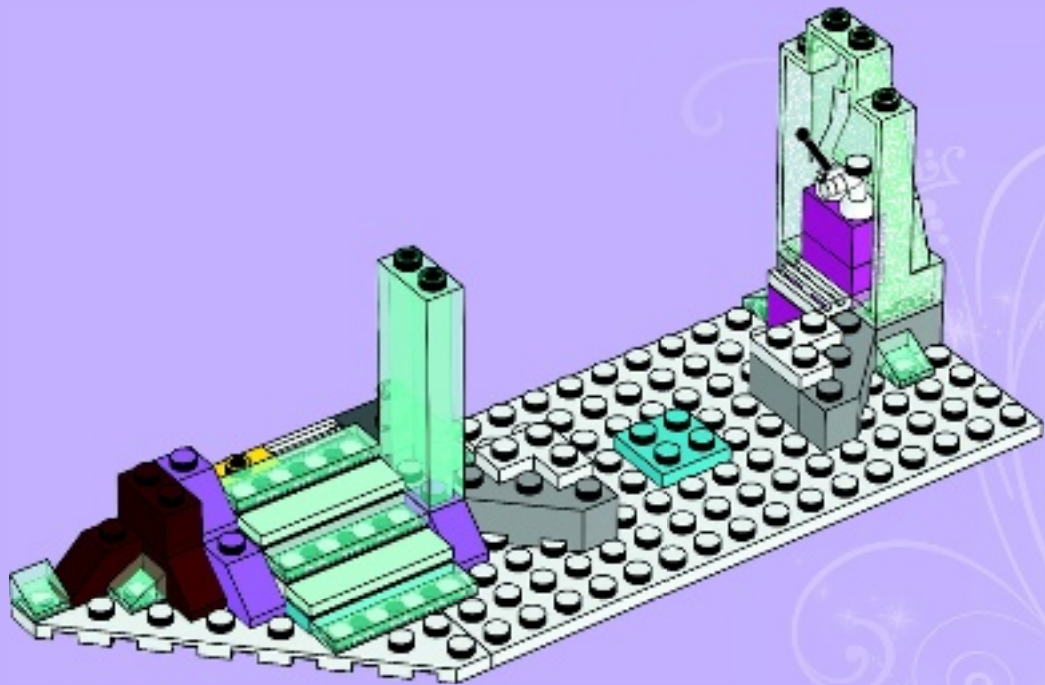

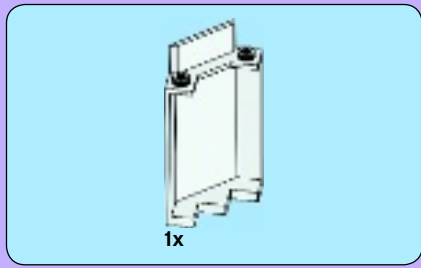

21

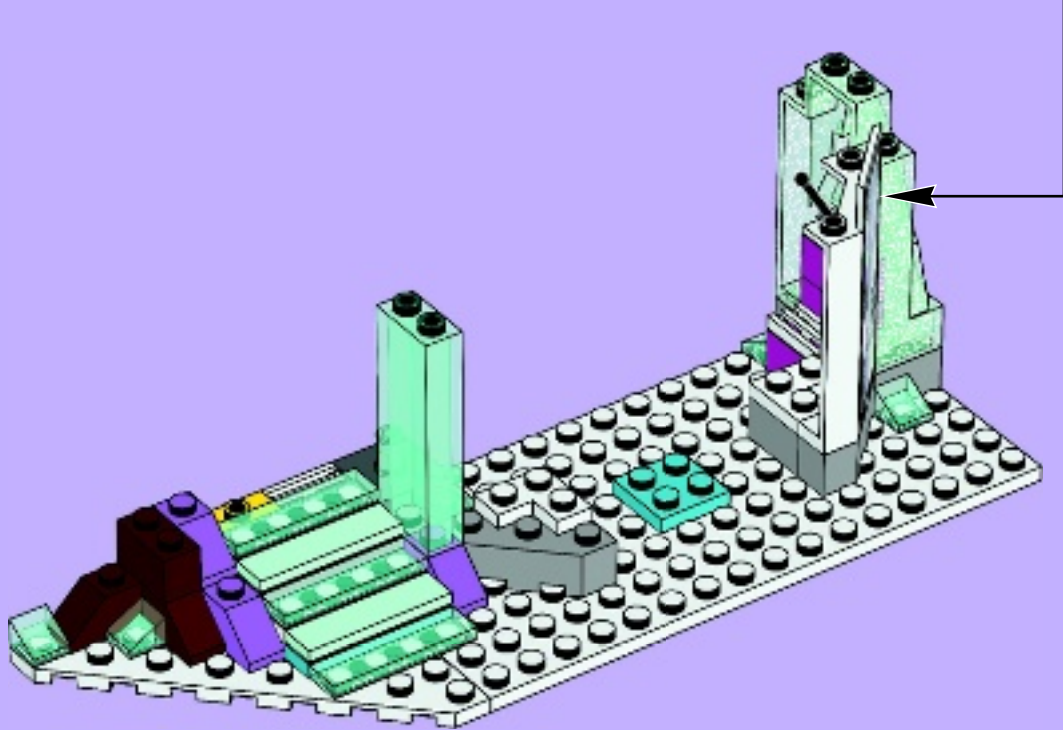
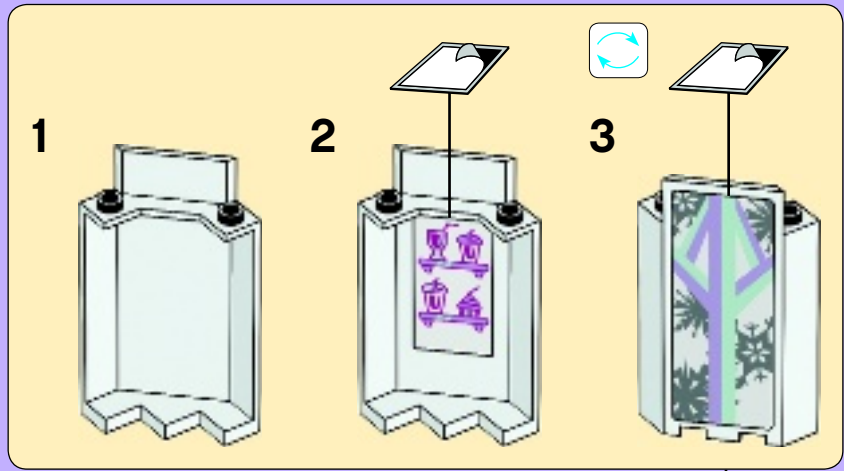

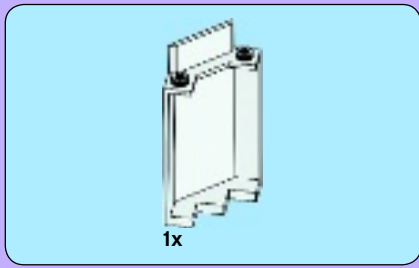

22

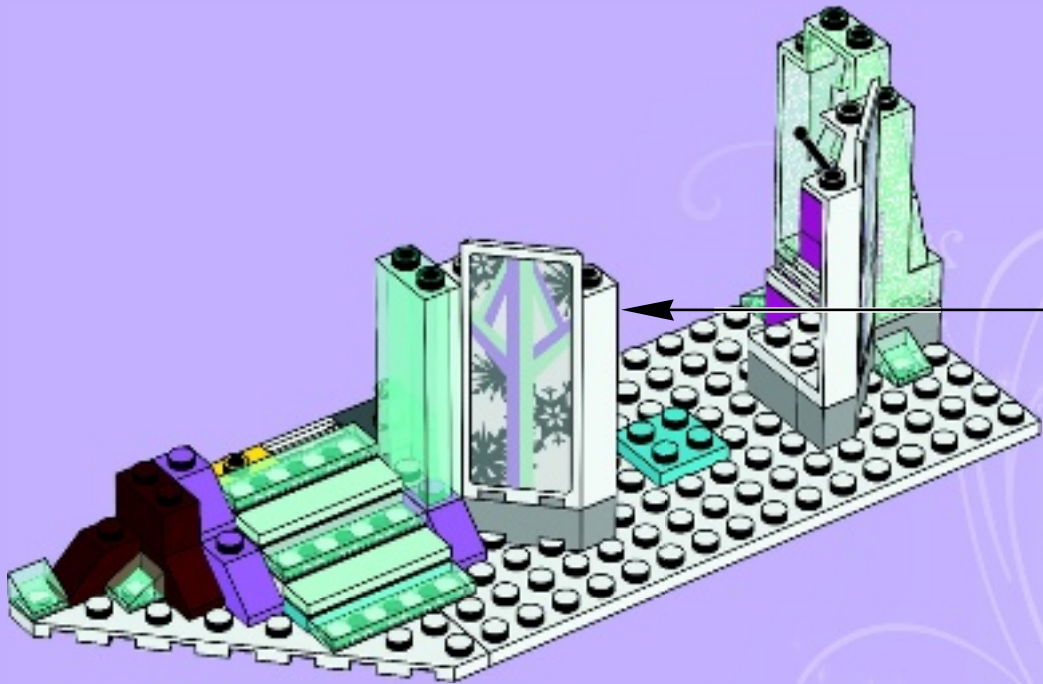
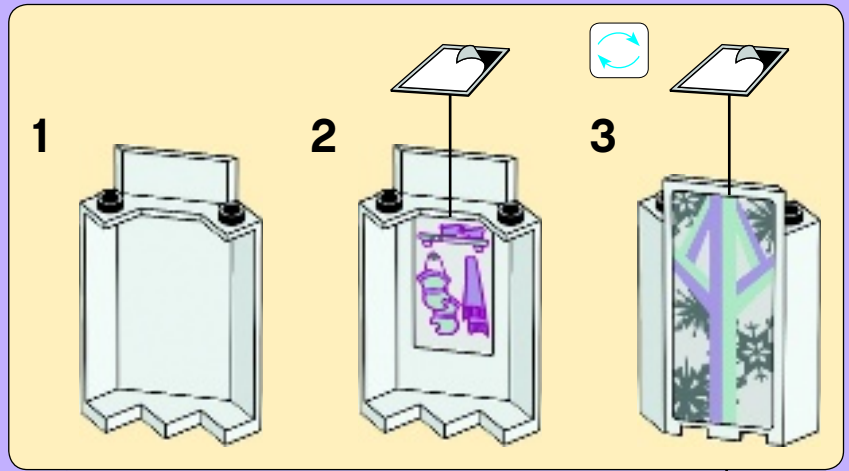



2x



1x



1x

# 23

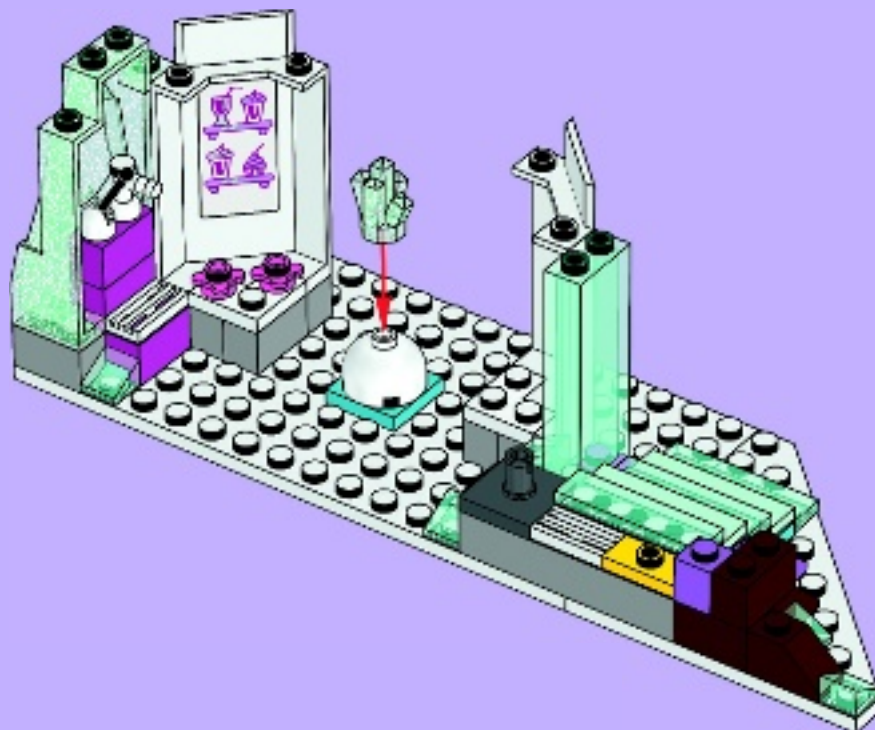
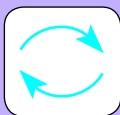



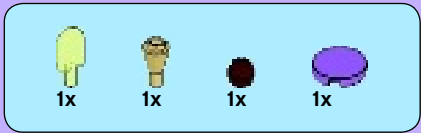

# 24

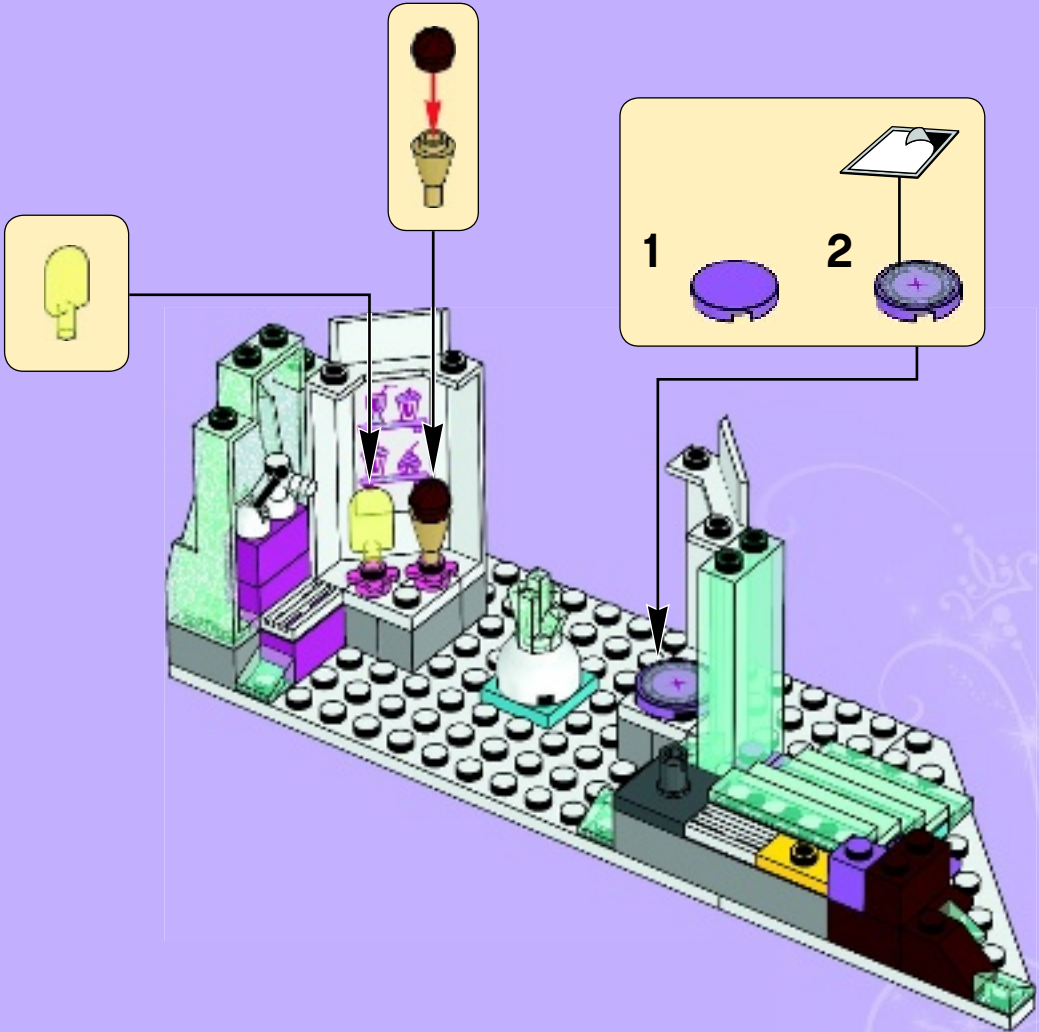

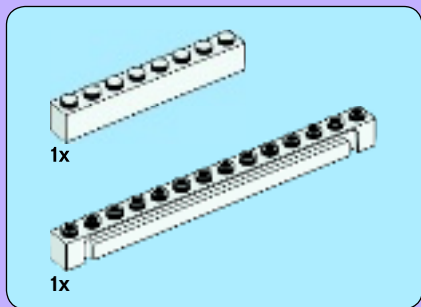

25

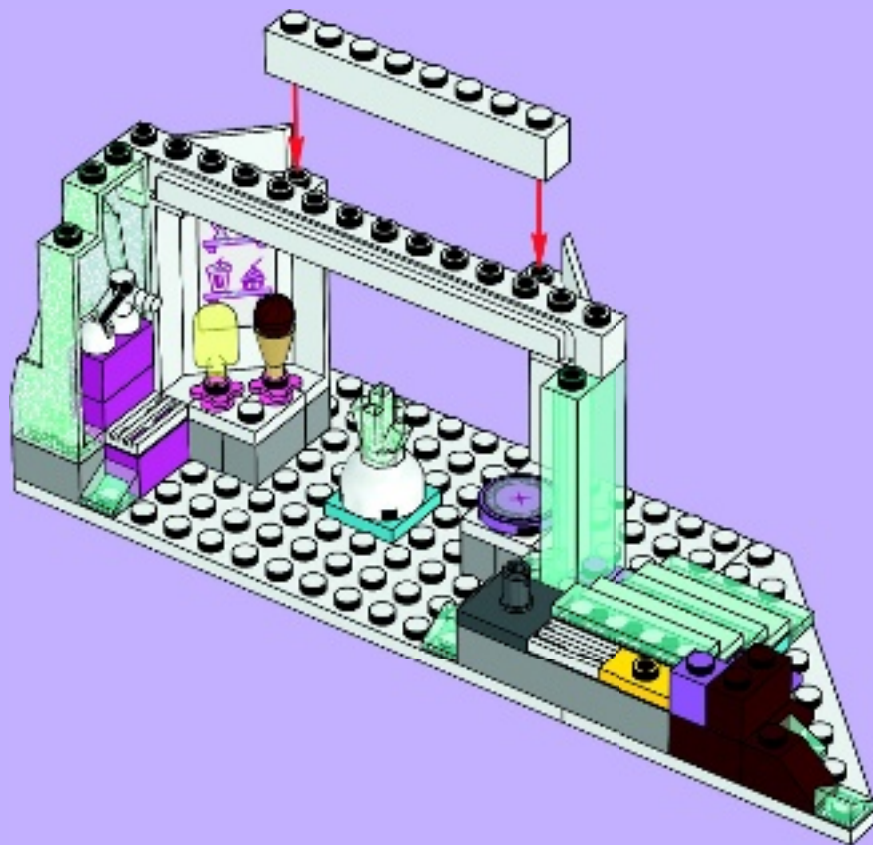



26



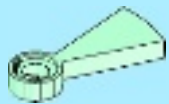

1x

# 27

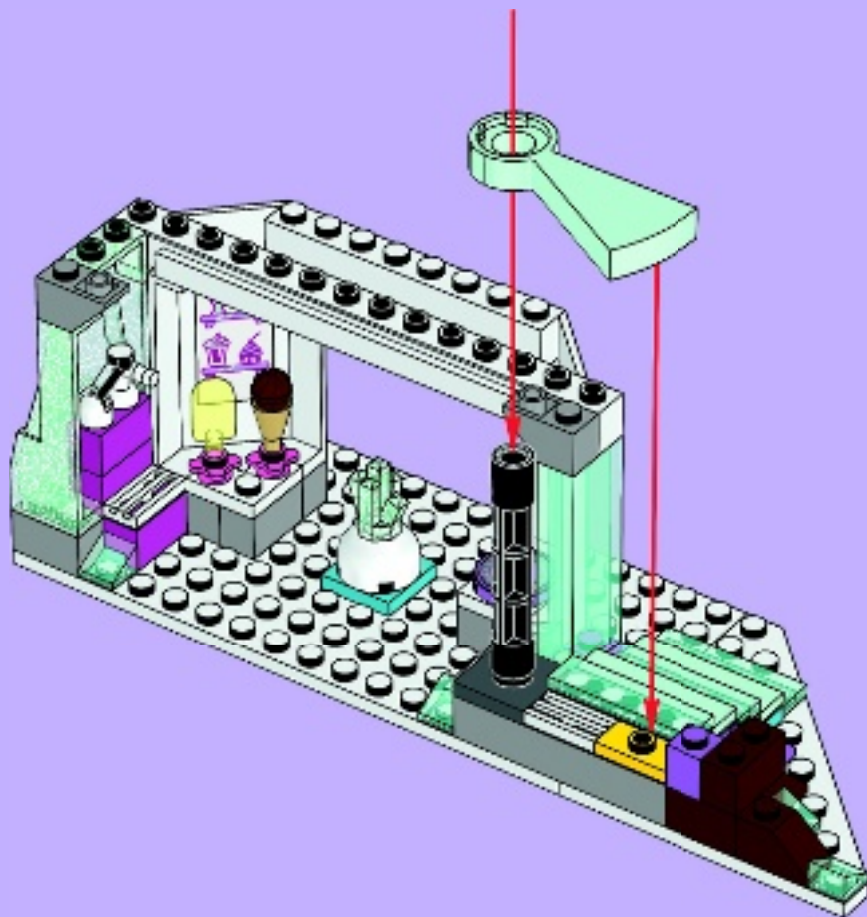



1x

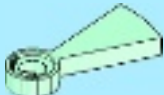

7x

# 28

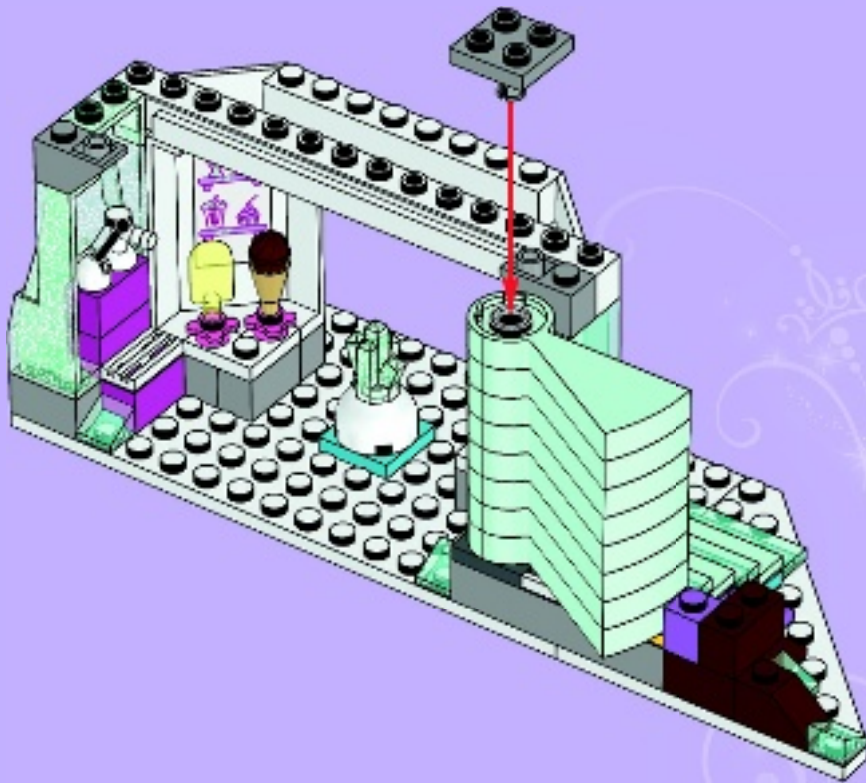



2x

29

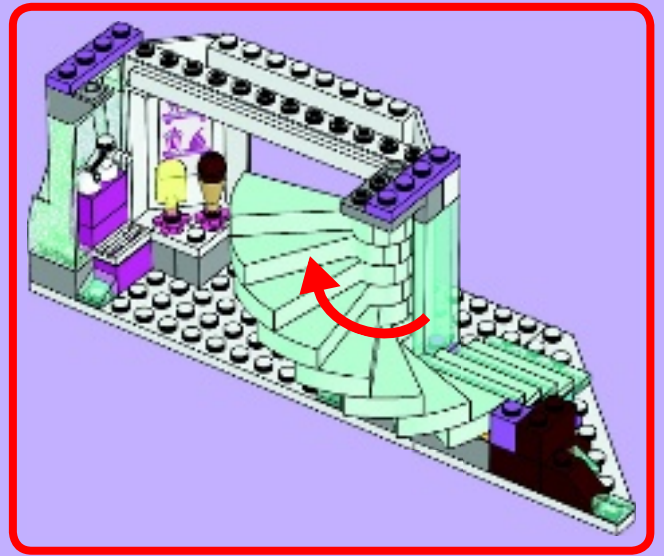

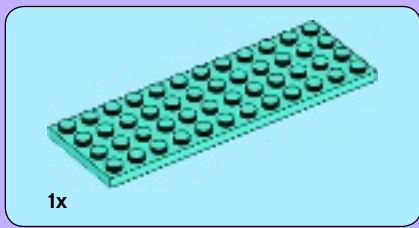

30

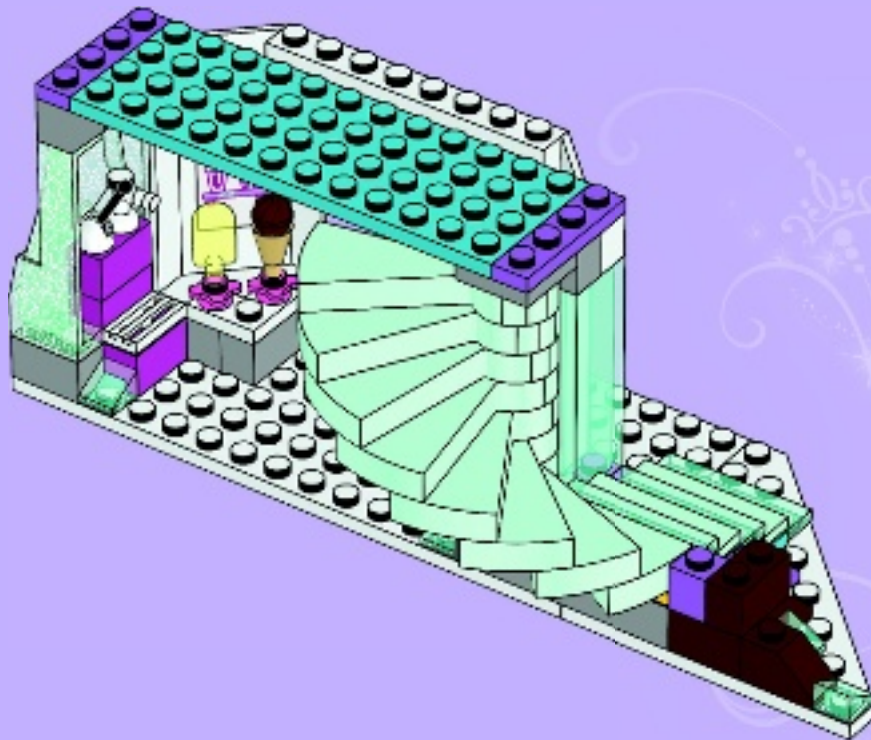



# 31

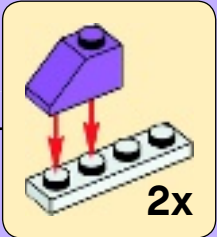
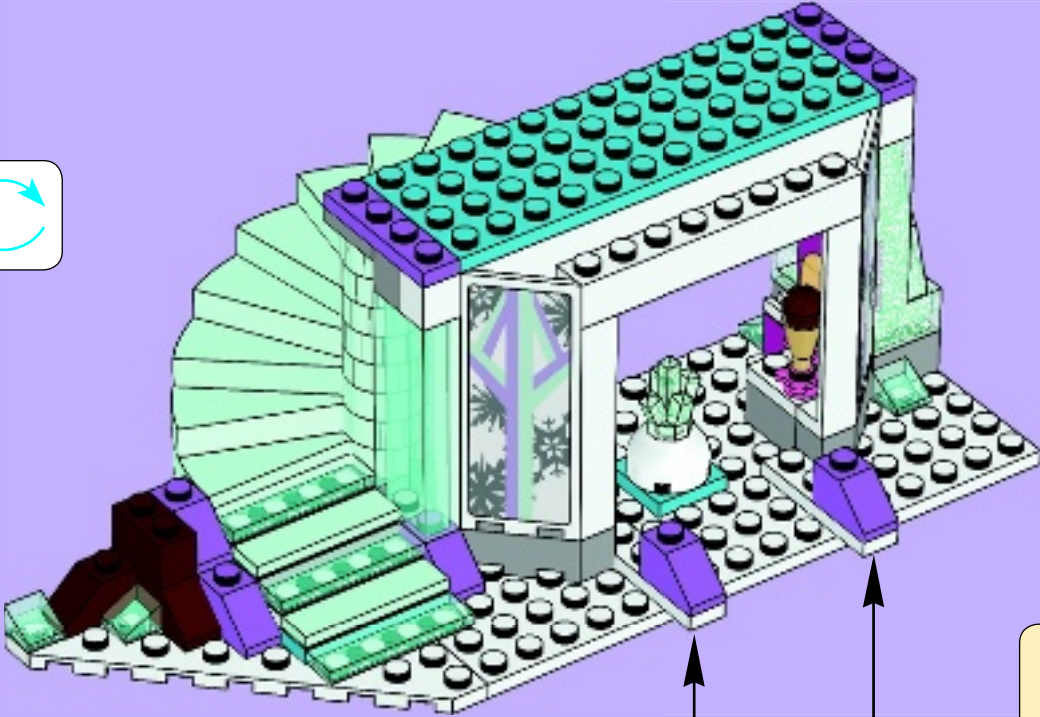



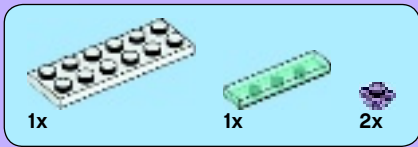

# 32

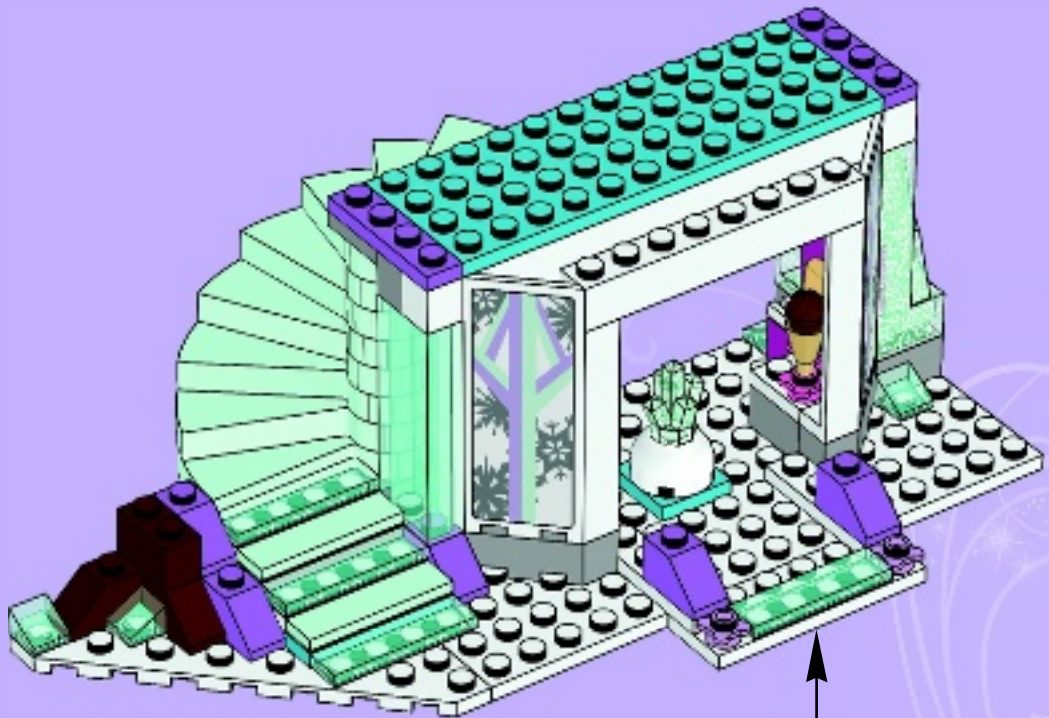



# 33

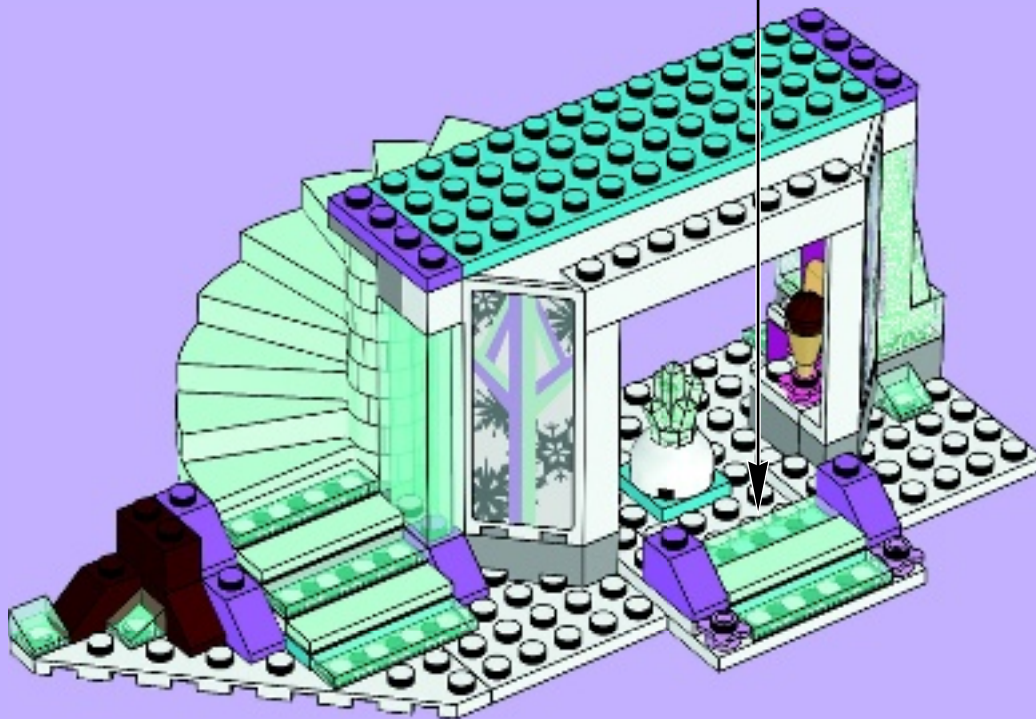
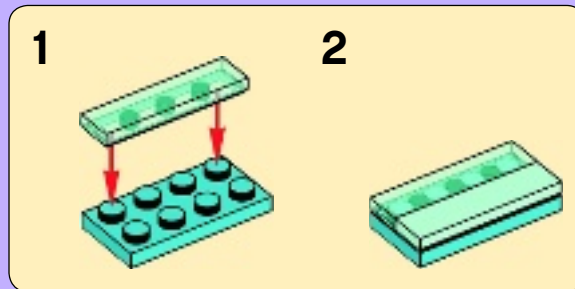

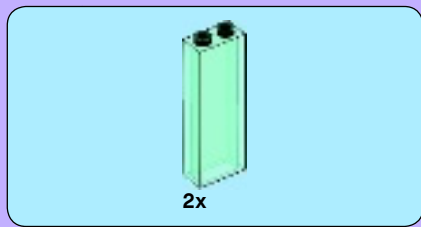

34

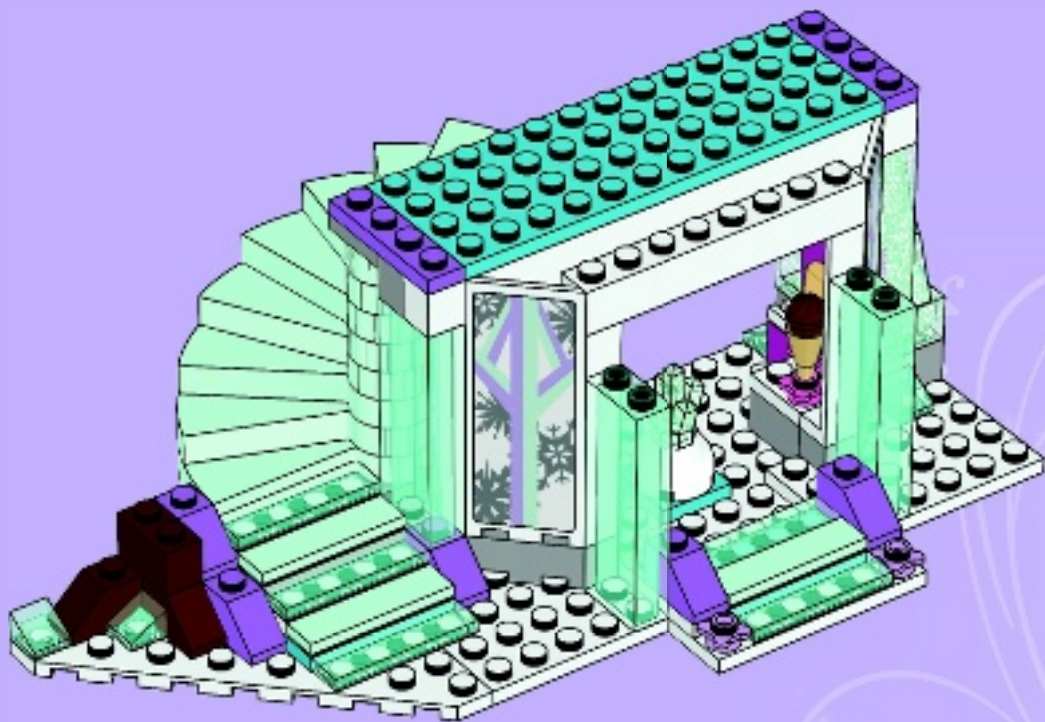

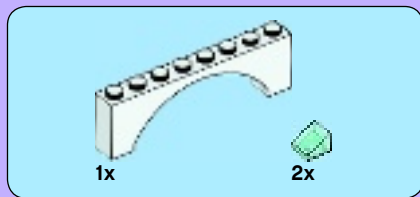

35

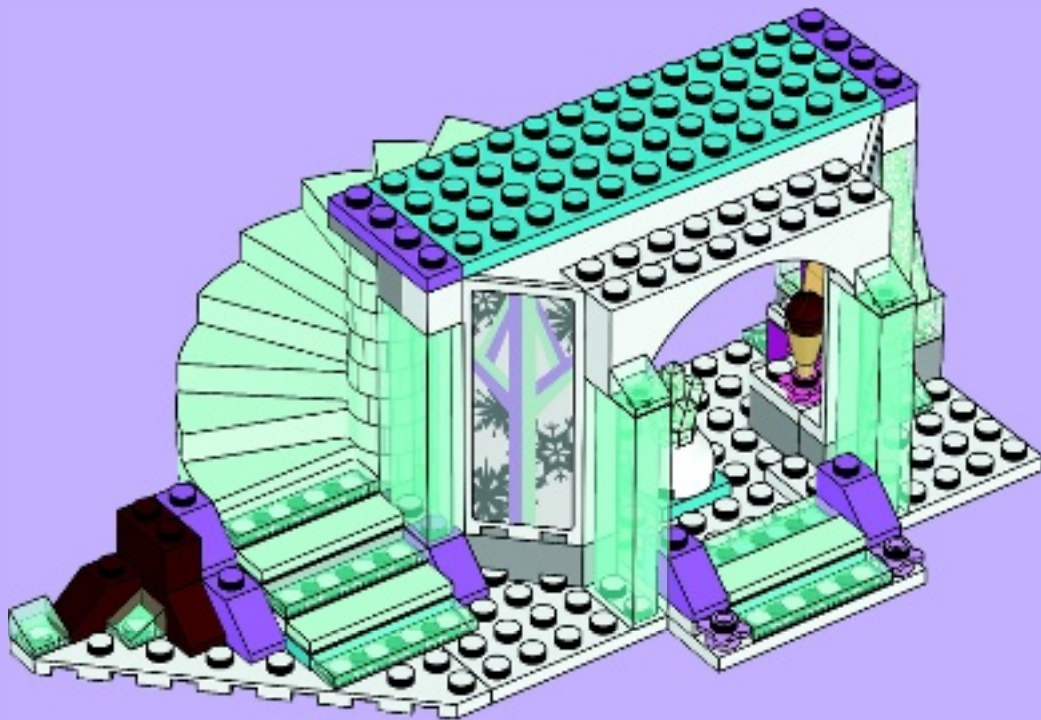



2x

# 36

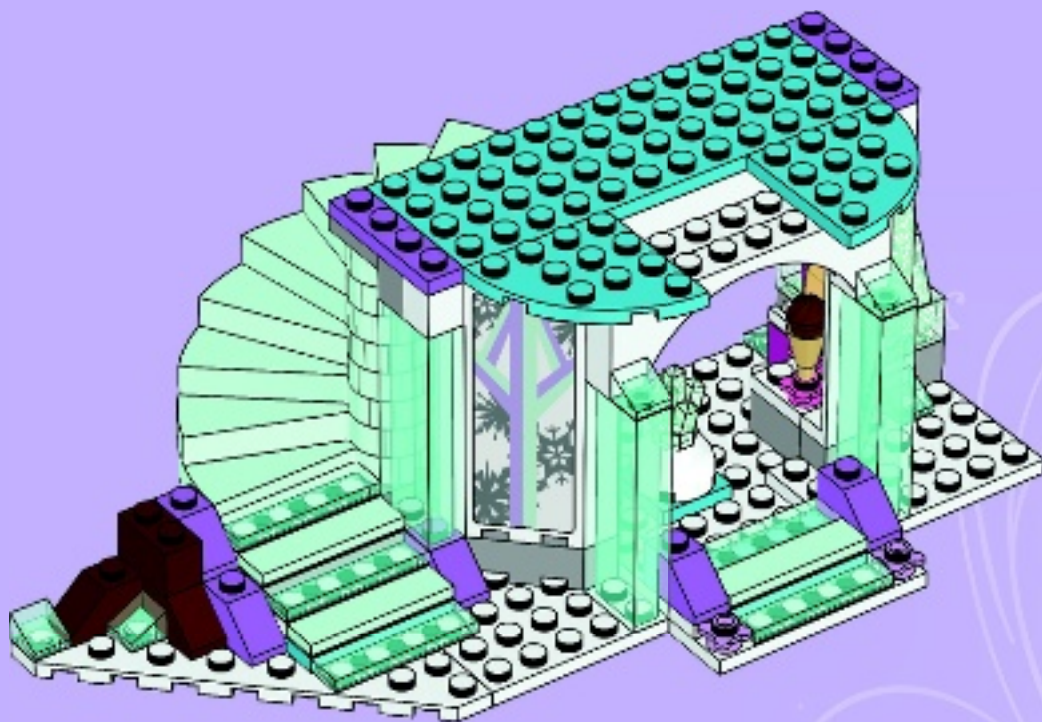



2x

# 37

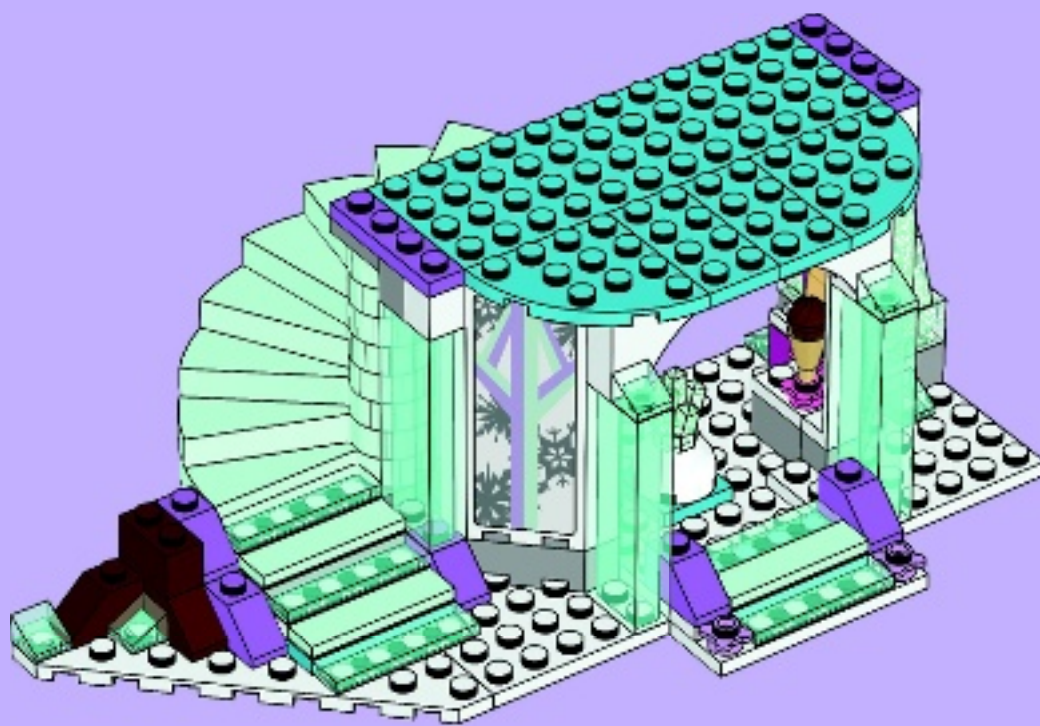

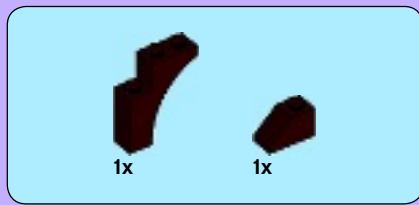

38



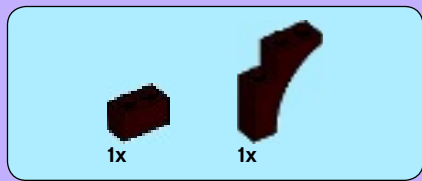

39

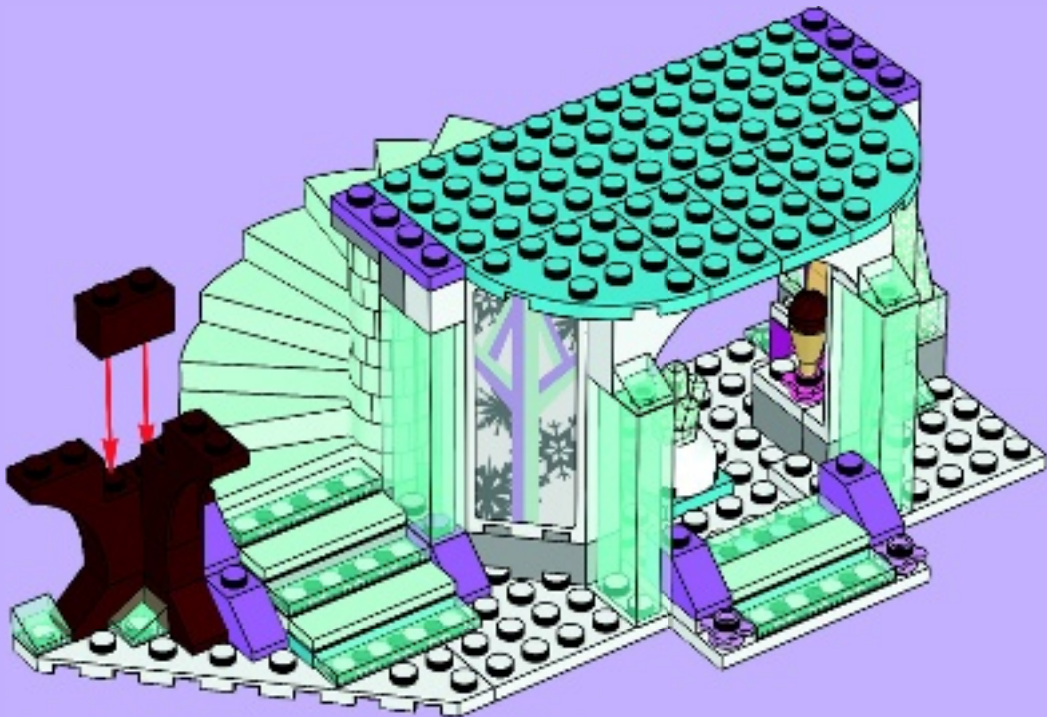





1x

# 40



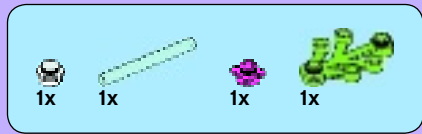

41

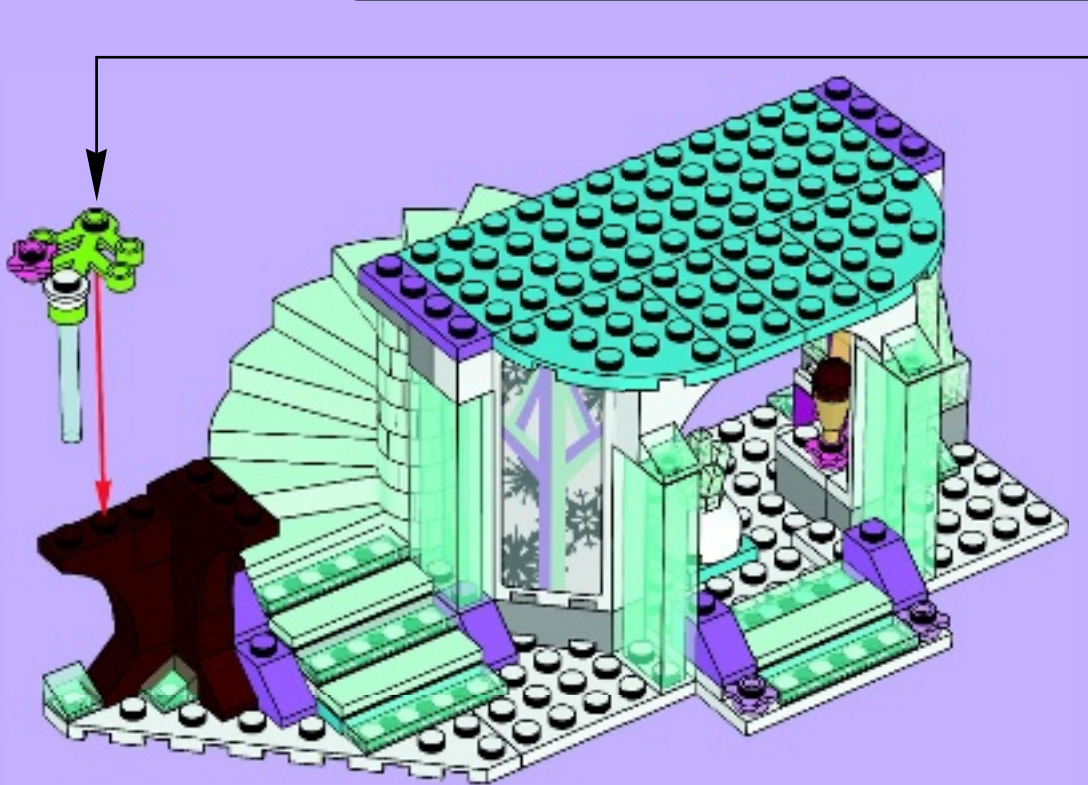
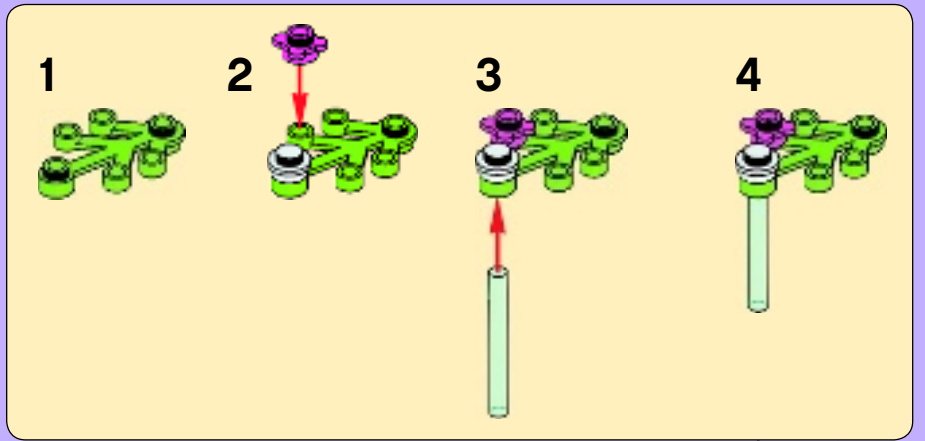

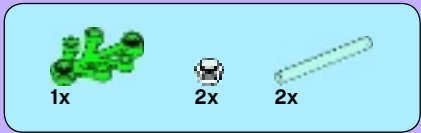

42

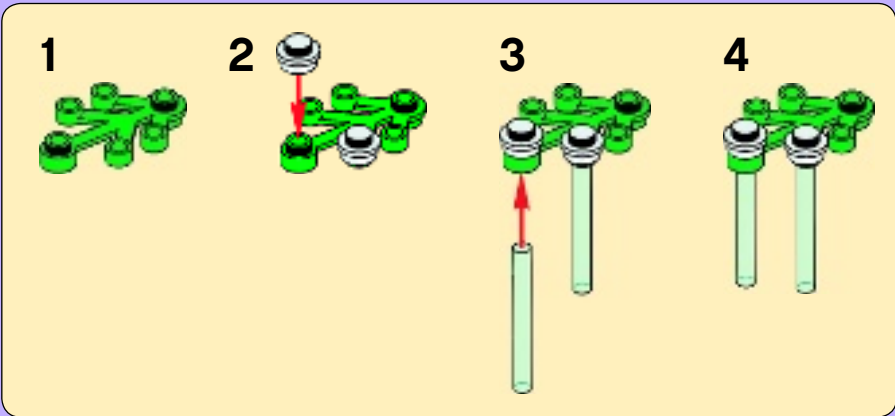

2x

43

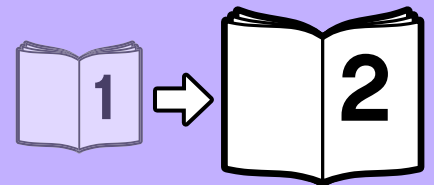



# Friends



41085



41086



41087



41088



41089

[LEGO.com/friendsvet](http://LEGO.com/friendsvet)

41062

FROZEN

41055

41054





# WIN

GO TO [WWW.LEGO.COM/PRODUCTFEEDBACK](http://WWW.LEGO.COM/PRODUCTFEEDBACK) AND  
GIVE US YOUR SHORT **FEEDBACK** ABOUT THIS  
LEGO® SET FOR A CHANCE TO WIN  
A COOL LEGO PRIZE.



## LEGO.com/productfeedback

### GEWINNE



Erzähle uns auf  
[www.LEGO.com/productfeedback](http://www.LEGO.com/productfeedback)

*etwas über die Erfahrungen, die du mit  
diesem LEGO® Set gemacht hast, und  
sichere dir die Chance auf einen coolen  
LEGO Preis!*

### GAGNE



Rends-toi sur  
[www.LEGO.com/productfeedback](http://www.LEGO.com/productfeedback)

*et donne-nous quelques commentaires  
sur ce produit LEGO® pour avoir une  
chance de gagner un prix LEGO !*

### GANA



Visita  
[www.LEGO.com/productfeedback](http://www.LEGO.com/productfeedback)

*y envíanos tu opinión acerca de este set  
LEGO®. ¡Participarás en el sorteo de un  
premio LEGO!*

### 获取奖品



登录  
[www.LEGO.com/productfeedback](http://www.LEGO.com/productfeedback)

*给出关于此乐高®套装的简短反馈，  
就有机会获得炫酷乐高高奖品*