



Architecture

Flatiron Building

New York City, NY, USA



Le Flatiron Building

New York, NY, États-Unis

Edificio Flatiron

Ciudad de Nueva York,
Nueva York (EE. UU.)



-  Booklet available in English on
-  Livret disponible en français sur
-  Folleto disponible en español en



[LEGO.com/architecture](https://www.lego.com/architecture)

Flatiron Building

Sitting on the intersection where Fifth Avenue and Broadway cross, the Flatiron Building (originally named the Fuller Building) remains one of New York City's most popular and memorable structures. Today it is difficult to imagine the controversy this architectural landmark created on its completion in 1902.

[I found myself agape, admiring a sky-scraper...
ploughing up through the traffic of Broadway
and Fifth Avenue in the afternoon light.]

H. G. Wells, 1906



© Per Tropp-Christiansen

History

As the city of New York expanded northward during the second half of the 19th century, small plots of land in between or on the edge of new buildings remained undeveloped. One of the most well known of these was the narrow triangular site at 23rd Street, between Fifth Avenue and Broadway. The "Flat Iron," as it quickly became known, changed owners many times, but wouldn't be developed until the Chicago-based Fuller Company bought the site in 1901.

The Fuller Company, a major Chicago-based contracting firm specializing in the construction of skyscrapers, planned to build a new showcase headquarter on the site. The founder of the company, George A. Fuller, had died the year before, and the new building would be named the Fuller Building in his honor.

The Fuller Company engaged Chicago architect Daniel H. Burnham to design the building and, utilizing the Fuller Company's expertise with steel frame construction, he proposed a 20-story structure that would reach a height of 285 ft. (86.9 m). A penthouse would be added in 1905, increasing the building's height to 307 ft. (93 m). The building's Broadway front would be 190 ft. (60 m) wide, the Fifth Avenue front 173 ft. (52.7 m) wide, and the 22nd Street side just short of 87 ft. (26.5 m) wide. At the "point" of the triangle the building would only be 6.5 ft. (2 m) wide and would form a 25-degree acute angle.

Burnham saw the building as a vertical Renaissance palazzo with Beaux-Arts, or neoclassical, styling. Visually the building would be divided into three distinct sections. It would consist of a richly decorated, three-story limestone façade at the bottom and a broad, repetitive midsection in a light tan monochrome terra cotta. The structure would then be topped off with a crowning cornice that would run the entire length of the building.



© Getty Images



© Getty Images

With its steel skeleton structure, the construction of the building was carried out rapidly and without major incident. While other New York skyscrapers at the time were often thin towers rising from pedestal-like blocks, the Flatiron was a single massive structure. This radical design, combined with its great height and unusual shape, created a great deal of debate as the building neared completion in 1902.

Many New Yorkers believed the structure would be unstable and would fall over at the first gust of wind. The building had even been nicknamed “Burnham’s Folly” and bets were placed on how far the debris would reach when it blew over. Strong winds came and went, and the Flatiron Building withstood them—as it continues to do today, over a century later. It is proof that the structure was not only a strong architectural idea, but a groundbreaking engineering marvel as well.

The Architect

Born in New York and raised in Chicago, Daniel H. Burnham would become one of the founding fathers of the first Chicago School of architects. Together with his then-partner John W. Root, Burnham built one of the first American skyscrapers, the 21-story Masonic Temple Building in Chicago in 1892, and planned the architectural layout of the largest World Fair ever held at that time in 1893.

Burnham's architecture mixed elements of Modernism with a more neoclassical style. Many of his buildings, including the Flatiron Building, followed the convention of the classical column: three distinct parts made up of a base, a middle section, and an ornate cornice at the top.

Burnham's early sketches for the Flatiron Building included a clock face and a far more elaborate crown at the top of the building, but he was persuaded to remove both by his former partner John W. Root. Although Burnham retained overall control of the project, he engaged the architect F. P. Dinkelberg (1859–1935) to carry out most of the supervising work during the actual construction.

After the Flatiron Building, Burnham would continue to work on a series of impressive architectural projects, including a number of major planning tasks for the cities of San Francisco, Washington, D.C., and Manila in the Philippines. At the time of his death in 1912, his D. H. Burnham & Co. architectural firm was the largest in the world.



Daniel Hudson Burnham (1846 – 1912)

© Wikipedia



© Wikipedia

Plan for the development of Manila, submitted to the Philippine Commission by D. H. Burnham, 1905



© Wikipedia

Plan for San Francisco by Daniel Burnham and William Bennett, published 1906



The Building Today

Although never the tallest building in New York, or even the first building in the country with a triangular ground plan, the Flatiron Building remains an iconic symbol of the city of New York. Its enduring popularity with tourists, artists, and photographers also makes it one of the most photographed buildings in the world.

The famous building has appeared in countless movies, TV series, and comics. It was home to Peter Parker's *Daily Bugle* in the *Spiderman* movies, and was even accidentally destroyed by the U.S. Army in the 1998 film *Godzilla*.

The building was designated a New York City Landmark in 1966, added to the National Register of Historic Places in 1979, and became a National Historic Landmark in 1989. Valued today at \$190 million, the Flatiron Building continues to function as a popular retail and office space, and is home to a large number of U.S. and international companies. In 2009, Sorgente Group of America acquired the majority stake of the Flatiron Building. Sorgente Group of America is the American Holding of Sorgente Group, an Italian real estate investment company.

[... appeared to be moving toward me like the bow of a monster ocean steamer—a picture of a new America still in the making.]

Photographer Alfred Stieglitz

Facts about Flatiron Building

Location: New York City, USA
Architect: D. H. Burnham & Co: Daniel H. Burnham
Style: Renaissance Revival with Beaux-Arts styling
Materials: Steel frame structure, façade of limestone and terra-cotta
Height: 1902: 285 ft. (86.9 m). Today: 307 ft. (93 m).
Weight: 3,680 tons (3,338.5 metric tons)
Opened: 1902





© Shutterstock

Le Flatiron Building

Situé à l'intersection de la Cinquième avenue et de Broadway, le Flatiron Building (appelé à l'origine Fuller Building) reste l'une des structures les plus populaires et les plus mémorables de New York. Il est aujourd'hui difficile d'imaginer la controverse que ce monument architectural suscita lorsque sa construction prit fin en 1902.

[Je me trouvais stupéfait, à admirer un gratte-ciel... en avançant dans la circulation de Broadway et de la Cinquième avenue dans la lumière de l'après-midi.]

H. G. Wells, 1906



© Per Tropp-Christiansen

Histoire

Alors que la ville de New York s'étendait vers le nord pendant la deuxième moitié du 19^e siècle, de petites parcelles de terrain entre les nouveaux bâtiments ou alentour restaient non construites. L'une des plus célèbres était un étroit terrain triangulaire situé au carrefour de la 23^e rue, la Cinquième avenue et Broadway. Le « Flat Iron », comme il fut rapidement connu, changea de propriétaires de nombreuses fois, mais rien n'y fut construit jusqu'à ce que la société Fuller de Chicago achète le terrain en 1901.

La société Fuller, une grande entreprise de Chicago spécialisée dans la construction de gratte-ciels, prévoyait de construire un nouveau siège social spectaculaire sur ce site. Le fondateur de l'entreprise, George A. Fuller, était décédé l'année précédente, et le nouveau bâtiment serait nommé Fuller Building en son honneur.

La société Fuller engagea l'architecte de Chicago Daniel H. Burnham pour concevoir le bâtiment. S'inspirant de l'expertise de la société Fuller en matière de construction à charpente d'acier, Burnham proposa une structure de 20 étages qui atteindrait une hauteur de 86,9 m. Un penthouse allait être ajouté en 1905, augmentant la hauteur du bâtiment à 93 m. La façade du bâtiment sur Broadway devait mesurer 60 m de large, la façade sur la Cinquième avenue 52,7 m de large et le côté sur la 22^e rue seulement un peu moins de 26,5 m de large. À la « pointe » du triangle, le bâtiment ne mesurerait que 2 m de large et formerait un angle aigu de 25 degrés.

Burnham voyait le bâtiment comme un palazzo vertical de la Renaissance avec un style Beaux-Arts ou néoclassique. Le bâtiment serait séparé visuellement en trois sections distinctes. Il serait composé d'une façade en pierre calcaire richement décorée pour les trois étages du bas, et d'une section intermédiaire large et répétitive en terre cuite monochrome beige clair. La structure serait ensuite couronnée d'une corniche sur toute la longueur du bâtiment.





© Getty Images

Grâce à la charpente en acier, la construction du bâtiment fut effectuée rapidement et sans incident majeur. Alors que d'autres gratte-ciels de New York à l'époque étaient souvent de fines tours s'élevant à partir de blocs ressemblant à des piédestaux, le Flatiron était une structure massive unique. Ce design radical, combiné avec sa grande hauteur et sa forme inhabituelle, suscita beaucoup de débats lorsque la construction du bâtiment prit fin en 1902.

De nombreux New-yorkais pensaient que la structure allait être instable et tomberait au premier coup de vent. Le bâtiment avait même été surnommé la « folie de Burnham », et des paris furent placés sur la distance qu'atteindraient les débris lorsqu'il s'écroulerait. Des vents forts allaient et venaient, et le bâtiment Flatiron leur résistait, comme il continue de le faire aujourd'hui, plus d'un siècle plus tard. Ceci est une preuve que la structure était non seulement une idée architecturale forte, mais aussi une merveille d'ingénierie.

L'architecte

Né à New York et élevé à Chicago, Daniel H. Burnham allait devenir l'un des pères fondateurs de l'École d'architecture de Chicago. Avec son partenaire de l'époque, John W. Root, Burnham construisit en 1892 l'un des premiers gratte-ciels américains, le bâtiment de 21 étages du temple maçonnique de Chicago, et créa en 1893 le plan architectural de la plus grande foire mondiale jamais organisée à l'époque.

L'architecture de Burnham mélangeait des éléments du Modernisme avec un style plus néoclassique. Beaucoup de ses bâtiments, y compris le Flatiron, suivaient les conventions de la colonne classique : trois parties distinctes, avec une base, une section intermédiaire et une corniche ornementée en haut.

Les premières esquisses de Burnham pour le Flatiron incluait une horloge en façade et une couronne beaucoup plus élaborée en haut du bâtiment, mais il fut convaincu de supprimer ces deux éléments par son ancien partenaire John W. Root. Burnham conserva le contrôle général du projet, mais il engagea l'architecte F. P. Dinkelberg (1859–1935) pour effectuer la majorité du travail de supervision pendant la construction.



© Wikipedia

Daniel Hudson Burnham (1846 – 1912)

Après le Flatiron Building, Burnham continua à travailler sur une série de projets architecturaux impressionnants, notamment plusieurs grands travaux de planification pour les villes de San Francisco, Washington, D.C., et Manille aux Philippines. Au moment de sa mort en 1912, son cabinet d'architecture, D. H. Burnham & Co., était le plus grand du monde.



© Wikipedia

Plan pour le développement de Manille, soumis à la Commission philippine par D. H. Burnham, 1905



© Wikipedia

Plan pour San Francisco par Daniel Burnham et William Bennett, publié en 1906



Le bâtiment aujourd'hui

Le Flatiron n'a jamais été le plus haut bâtiment de New York, ni même le premier immeuble du pays avec un plan triangulaire, mais il reste cependant un symbole célèbre de New York. Sa popularité auprès des touristes, des artistes et des photographes en fait aussi l'un des bâtiments les plus photographiés au monde.

Ce célèbre bâtiment est apparu dans d'innombrables films, séries télé et bandes dessinées. Il abritait le journal *Daily Bugle* de Peter Parker dans les films de *Spiderman* et fut même accidentellement détruit par l'armée américaine dans le film *Godzilla* de 1998.

Le bâtiment devint un bâtiment historique de la ville de New York en 1966, fut ajouté au registre national des lieux historiques en 1979, et devint un monument historique national en 1989. Évalué aujourd'hui à 190 millions de dollars, le Flatiron Building continue de servir d'espace populaire de bureaux et de magasins, et abrite de nombreuses sociétés américaines et internationales. En 2009, le Sorgente Group of America acquit une participation majoritaire dans le Flatiron Building. Sorgente Group of America est la société de portefeuille américaine du Sorgente Group, une entreprise italienne d'investissement immobilier.

[... semblait avancer vers moi comme la proue d'un énorme transatlantique, une image d'une nouvelle Amérique en construction.]

Alfred Stieglitz, photographe

Informations sur le Flatiron Building

Lieu : New York, États-Unis
Architecte : D. H. Burnham & Co ; Daniel H. Burnham
Style : Néo-Renaissance avec style Beaux-Arts
Matériaux : Charpente en acier, façade en pierre calcaire
et terre cuite
Hauteur : 1902 : 86,9 m. Aujourd'hui : 93 m.
Poids : 3 338,5 tonnes
Inauguration : 1902





© Shutterstock

Edificio Flatiron

Situado en el cruce entre la Quinta Avenida y Broadway, el Edificio Flatiron (bautizado como «Edificio Fuller») continúa siendo una de las estructuras más populares y emblemáticas de la ciudad de Nueva York. Hoy es difícil imaginar la controversia que generó este hito arquitectónico cuando se inauguró en 1902.

[Me encontré a mí mismo boquiabierto, admirando un rascacielos... abriéndome paso a través del tráfico de Broadway y la Quinta Avenida bajo la luz de la tarde.] H.G. Wells, 1906



© Per Tropp-Christiansen

Historia

La expansión hacia el Norte que experimentó la ciudad de Nueva York durante la segunda mitad del siglo XIX dio lugar a la aparición de pequeños espacios sin construir entre los nuevos edificios o junto a ellos. Uno de los más populares era el estrecho terreno triangular de la Calle 23, entre la Quinta Avenida y Broadway. El «Flat Iron», como comenzó a conocerse poco después, cambió de propietario varias veces, pero ninguno de ellos se decidió a construir en él hasta que Fuller Company, una compañía con sede en Chicago, adquirió el sitio en 1901.

Fuller Company, una importante firma contratista con sede en Chicago especializada en la construcción de rascacielos, planeaba construir una nueva sucursal que le sirviese de escaparate. El fundador de la compañía, George A. Fuller, había muerto un año antes, y el nuevo edificio se bautizaría como «Edificio Fuller» en su honor.

Fuller Company encargó el diseño del edificio a Daniel H. Burnham (un arquitecto de Chicago), quien, aprovechando la experiencia de Fuller Company en la construcción de estructuras de acero, propuso un edificio de 20 plantas que alcanzaría una altura de 86,9 m. En 1905 se construiría un ático que elevaría la altura del edificio hasta los 93 m. La fachada del edificio orientada hacia Broadway poseería 60 m de anchura; la orientada hacia la Quinta Avenida, 52,7 m; y la orientada hacia la Calle 22, tan sólo 26,5 m. En la «punta» del triángulo, el edificio mediría sólo 2 m de ancho y formaría un ángulo agudo de 25 grados.

Burnham concibió el edificio como un *palazzo* renacentista de estilo «Beaux-Arts» o neoclásico. Visualmente, el edificio se dividiría en tres secciones diferentes. De este modo, se compondría de una fachada de tres plantas en piedra caliza generosamente decorada en la parte inferior, y una amplia sección central iterativa en terracota marrón claro. Finalmente, la estructura quedaría coronada por una cornisa que recorrería la totalidad del perímetro del edificio.





© Gettyimages

Gracias a su estructura de acero, la construcción del edificio tuvo lugar rápidamente y sin mayores inconvenientes. Mientras que otros rascacielos neoyorquinos de la época eran a menudo comparables a una delgada torre construida con bloques a modo de pedestal, el Edificio Flatiron era una única y enorme estructura. Este radical diseño, sumado a su gran altura e inusual forma, dio lugar a intensas discusiones cuando la construcción se acercaba a su final en 1902.

Muchos neoyorquinos creían que la estructura sería inestable y se derrumbaría con la primera ráfaga de viento. Algunos incluso apodaron el edificio como «la locura de Burnham» y apostaron a la distancia que alcanzarían los escombros cuando fuese derribado. Fuertes vientos fueron y vinieron, y el Edificio Flatiron los soportó... y continúa soportándolos hoy, más de un siglo después. Es una prueba de que la estructura no sólo era una sólida idea arquitectónica, sino también una revolucionaria maravilla de la ingeniería.

El arquitecto

Nacido en Nueva York y criado en Chicago, Daniel H. Burnham se convertiría en uno de los padres fundadores de la primera Escuela de Chicago de arquitectura. Junto con su entonces socio, John W. Root, Burnham construyó uno de los primeros rascacielos de América (el edificio del Templo Masónico de Chicago, de 21 plantas, en 1892) y planificó el diseño arquitectónico de la feria mundial más grande jamás celebrada en 1893.

La arquitectura de Burnham mezclaba elementos de modernismo con otros más neoclásicos. Muchos de sus edificios, incluido el Flatiron, respetaron la convención de la columna clásica, compuesta por tres partes diferentes: una base, una sección central y una cornisa ornamental en la parte superior.

Los primeros esquemas del Edificio Flatiron bosquejados por Burnham incluían un reloj y una cornisa más elaborada, pero su antiguo socio (John W. Root), lo convenció para que eliminase ambas cosas. Aunque Burnham mantuvo el control del proyecto en general, contrató al arquitecto F. P. Dinkelberg (1859–1935) para que llevase a cabo la mayor parte del trabajo de supervisión durante la construcción.



© Wikipedia

Daniel Hudson Burnham (1846 – 1912)

Después de trabajar en el Edificio Flatiron, Burnham continuó trabajando en una serie de impresionantes proyectos arquitectónicos, entre ellos el planeamiento urbanístico de ciudades como San Francisco, Washington, D.C. y Manila (Filipinas). Cuando murió en 1912, su estudio de arquitectos (D. H. Burnham & Co.) era el más grande del mundo.



© Wikipedia

Planeamiento urbanístico de Manila, presentado a la Comisión Filipina por D. H. Burnham en 1905



© Wikipedia

Planeamiento urbanístico de San Francisco, por Daniel Burnham y William Bennett, publicado en 1906



El edificio en la actualidad

Incluso sin haber sido nunca el edificio más alto de Nueva York (ni siquiera el primer edificio del país de planta triangular), el Edificio Flatiron continúa siendo un emblema de la ciudad de Nueva York. Su permanente popularidad entre turistas, artistas y fotógrafos lo ha convertido, además, en uno de los edificios más fotografiados del mundo.

El popular edificio ha aparecido en innumerables películas, series para televisión y cómics. En él se encuentra la supuesta sede del *Daily Bugle*, el periódico en el que trabaja Peter Parker en las películas de *Spiderman*, e incluso fue accidentalmente destruido por el ejército de los EE. UU. en *Godzilla* (1998).

El edificio fue declarado patrimonio de la ciudad de Nueva York en 1966 e inscrito en el Registro Nacional de Lugares Históricos en 1979, y se convirtió en Monumento Histórico Nacional de EE. UU. en 1989. Valorado en 190 millones de dólares, el Edificio Flatiron sigue albergando comercios y oficinas, y es la sede de un gran número de compañías estadounidenses e internacionales. En 2009, Sorgente Group of America adquirió la mayor parte del Edificio Flatiron. Sorgente Group of America es el brazo americano de Sorgente Group, una compañía italiana de inversión inmobiliaria.

[...parecía avanzar hacia mi como la proa de un monstruoso transatlántico; una imagen de una nueva América aún en construcción.]

Alfred Stieglitz, fotógrafo

Ficha de características del Edificio Flatiron

Situación: Ciudad de Nueva York (EE. UU.)
Arquitecto: D. H. Burnham & Co: Daniel H. Burnham
Estilo: Neorrenacentista con elementos «Beaux-Arts»
Materiales: Estructura de acero, fachada de piedra caliza y terracota
Altura: 1902: 86,9 m; hoy: 93 m
Peso: 3.338,5 toneladas métricas
Inauguración: 1902





© Shutterstock

[What the Parthenon was to Athens,
the Flatiron Building is to New York.]

Photographer Alfred Stieglitz

[Ce que le Parthénon était à Athènes,
le Flatiron est à New York.]

Alfred Stieglitz, photographe

[Lo que el Partenón fue para Atenas,
el Edificio Flatiron lo es para Nueva York.]

Alfred Stieglitz, fotógrafo



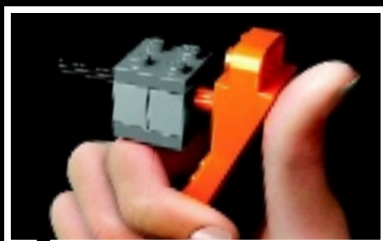

LEGO.com/brickseparator



1x

1

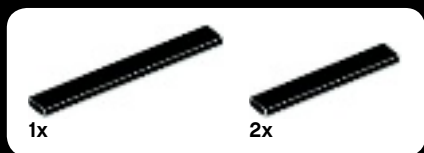
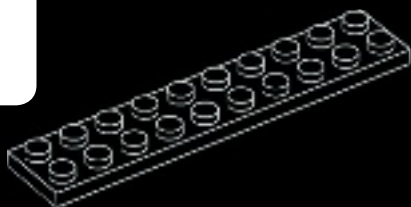

1x

2x

2

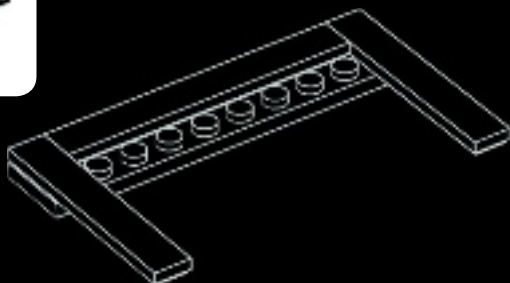

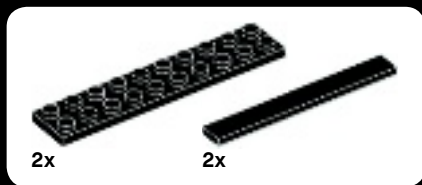

3

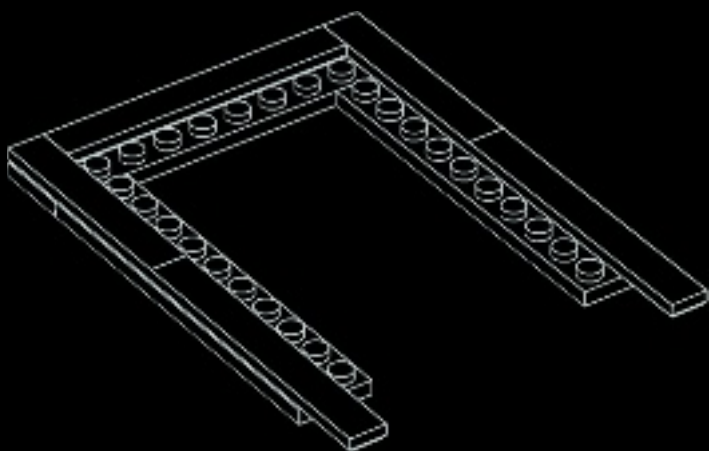

4

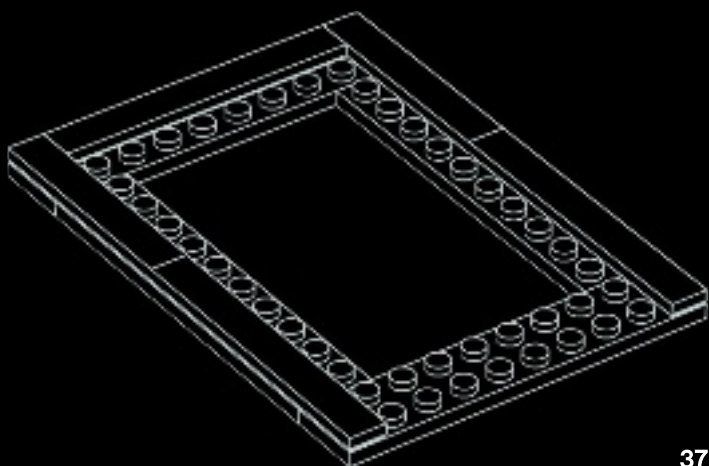



2x

1x

5

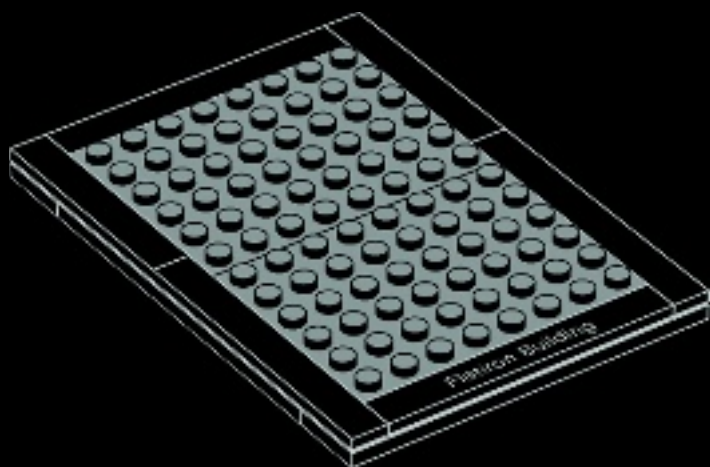

4x



4x



8x

6

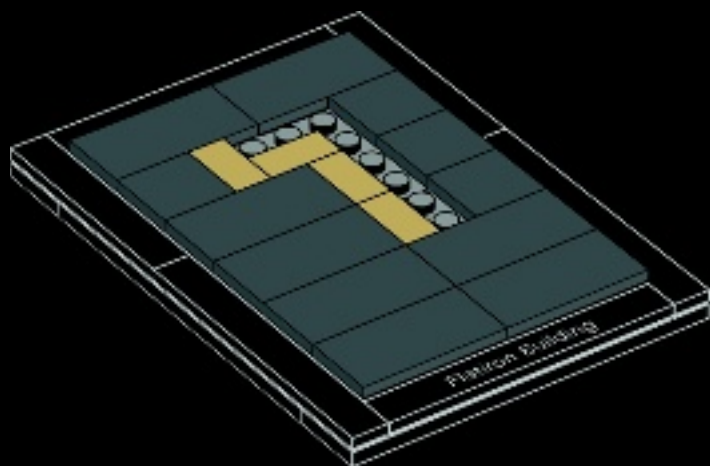



7

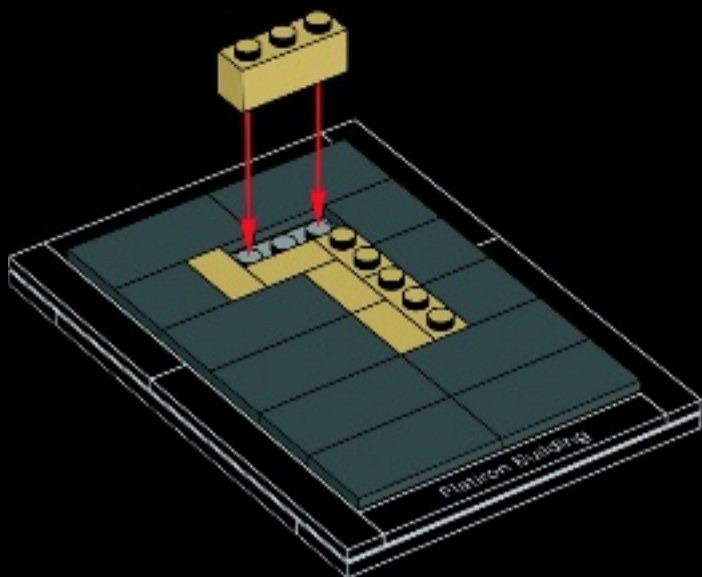

8

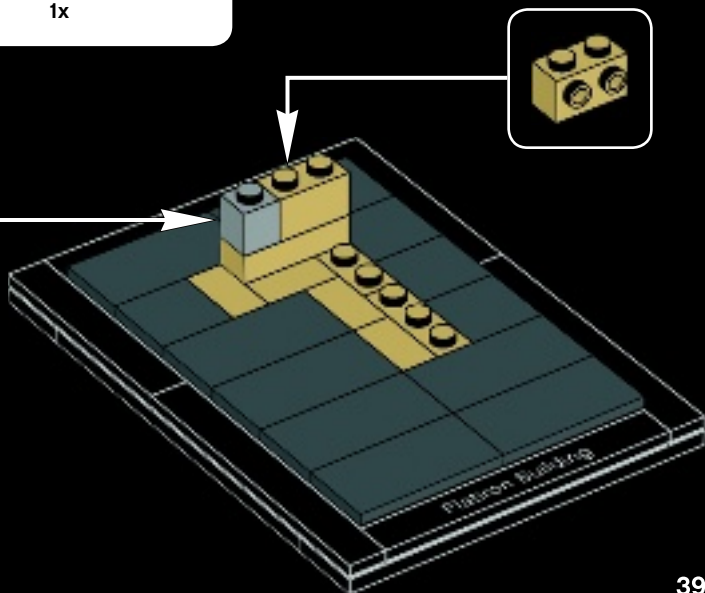



1x



1x

9

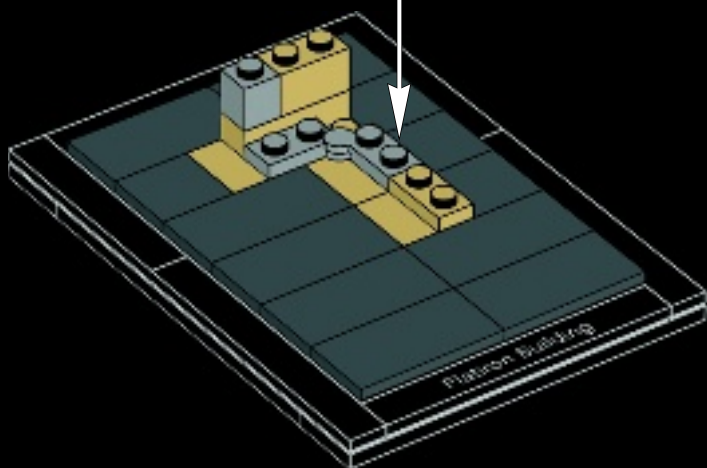

1x



1x



1x



1x



1x

10

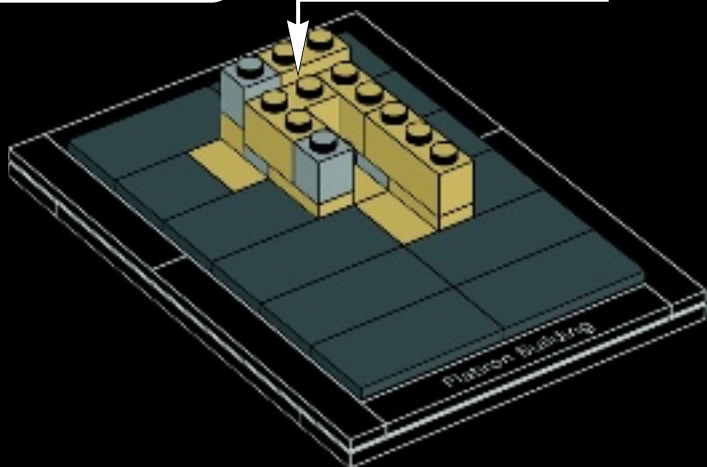
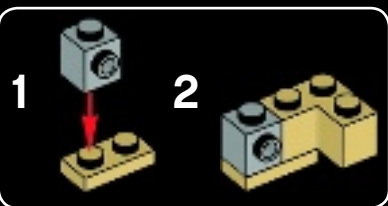



2x



1x



2x

11

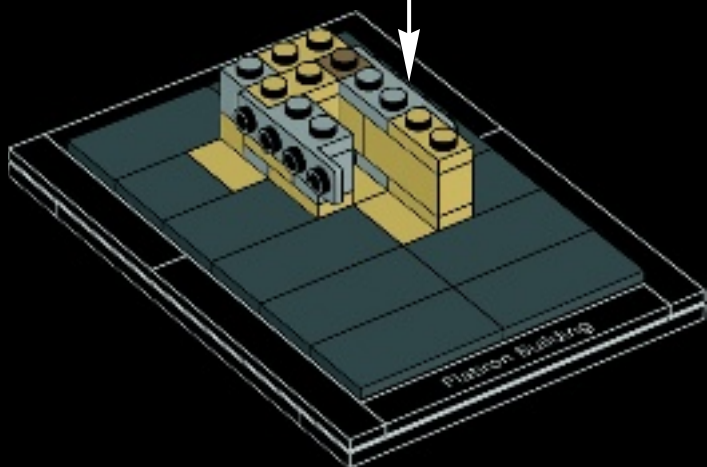

1x



1x

12

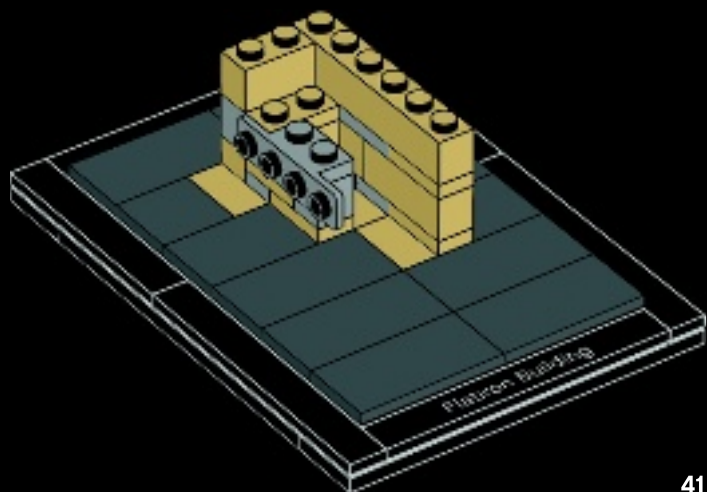



1x



1x

13

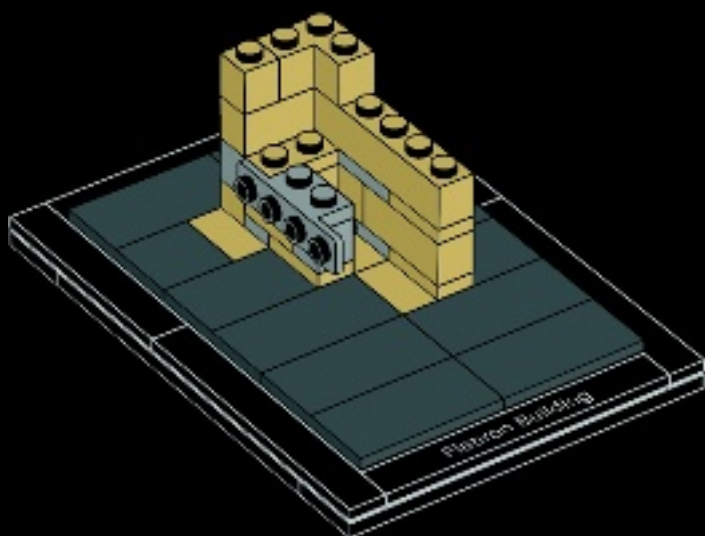

2x



1x



1x

14

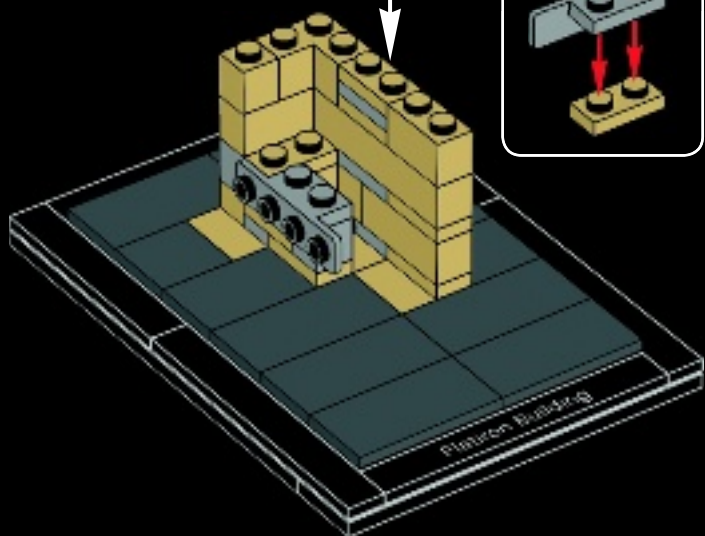



1x

15

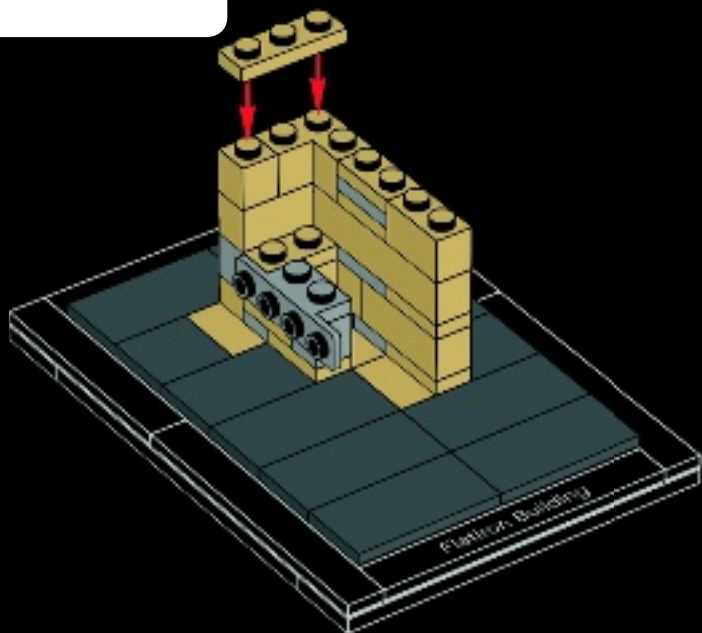

1x



1x

16

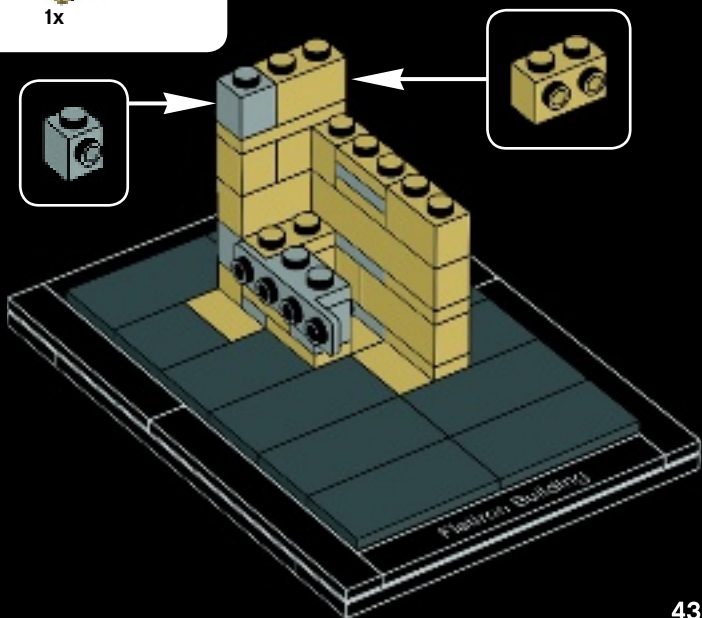



1x



1x

17

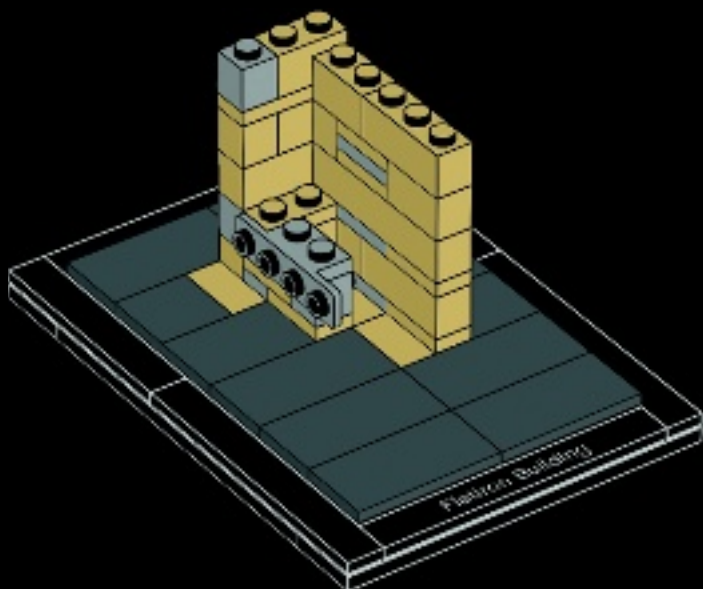

1x



1x



1x

18

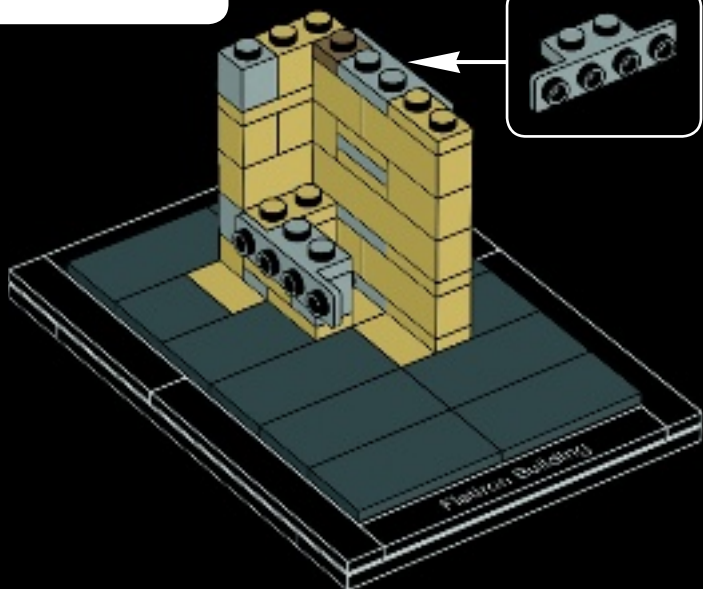



1x



1x

19

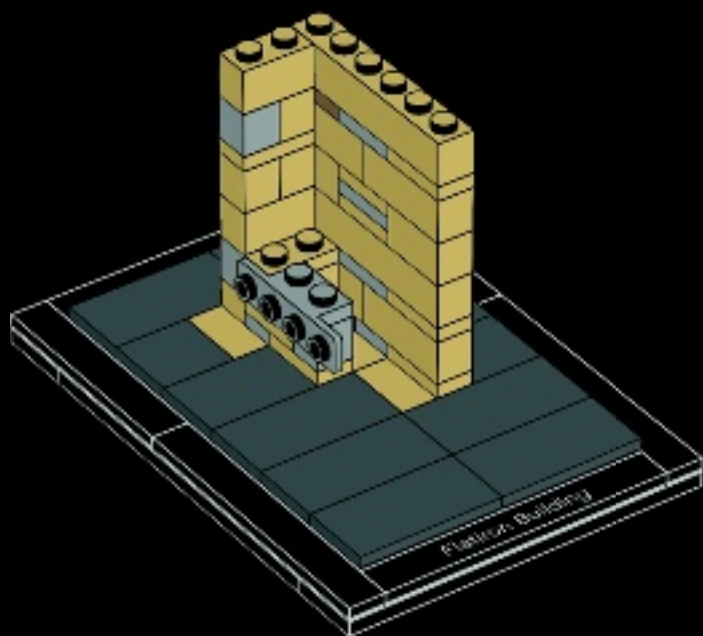



1x



2x

20

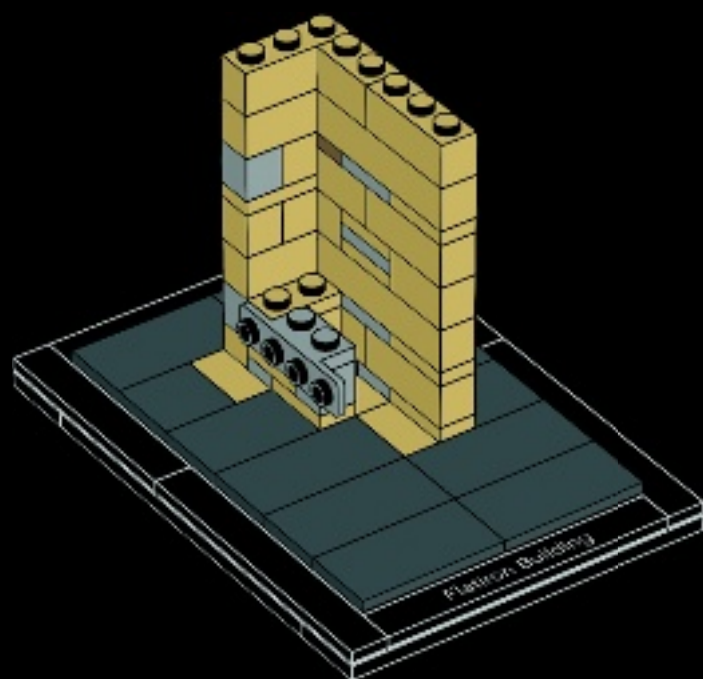



1x



1x

21

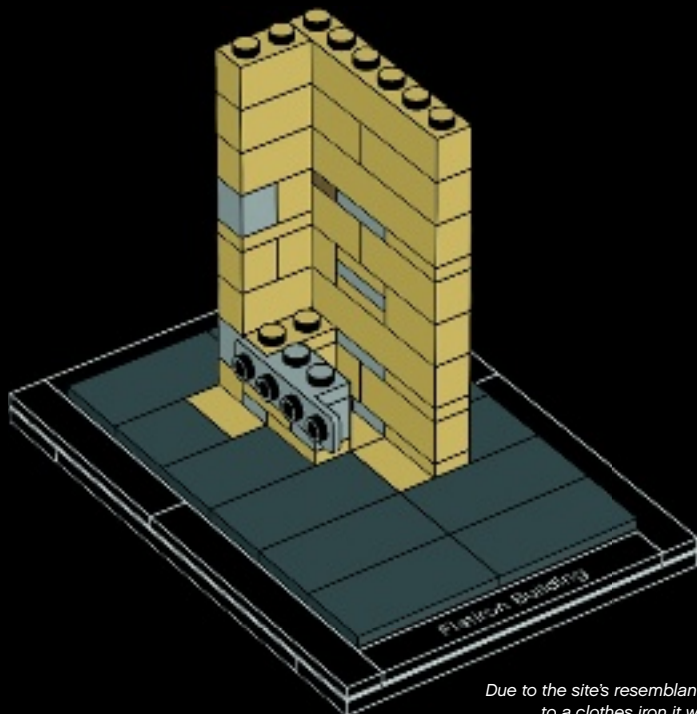

Due to the site's resemblance to a clothes iron it was called the "Flat Iron" long before the building itself was constructed.

En raison de la ressemblance du terrain avec un fer à repasser, il fut appelé le « Flat Iron » (fer à repasser en anglais) bien avant la construction du bâtiment.

El parecido entre la forma del sitio y una plancha le valió el apodo «Flat Iron» (plancha, en inglés) mucho antes de que se proyectase la construcción del edificio.



© Shutterstock



1x



1x

22

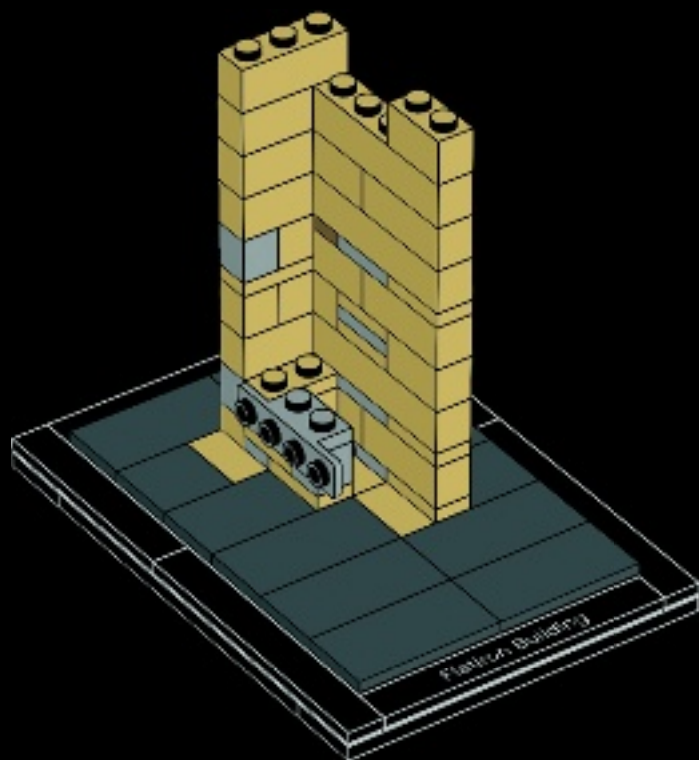

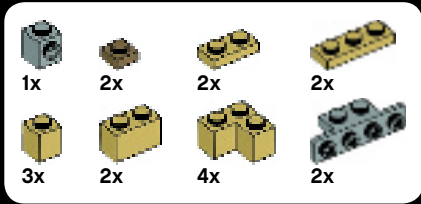

23

1



2



3

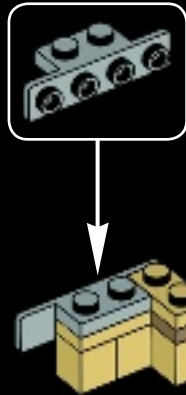

4

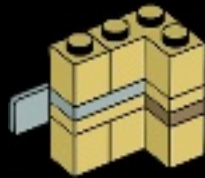

5





6

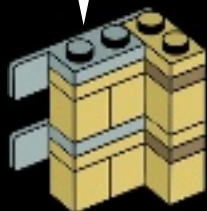

8



7

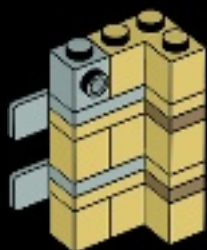

9



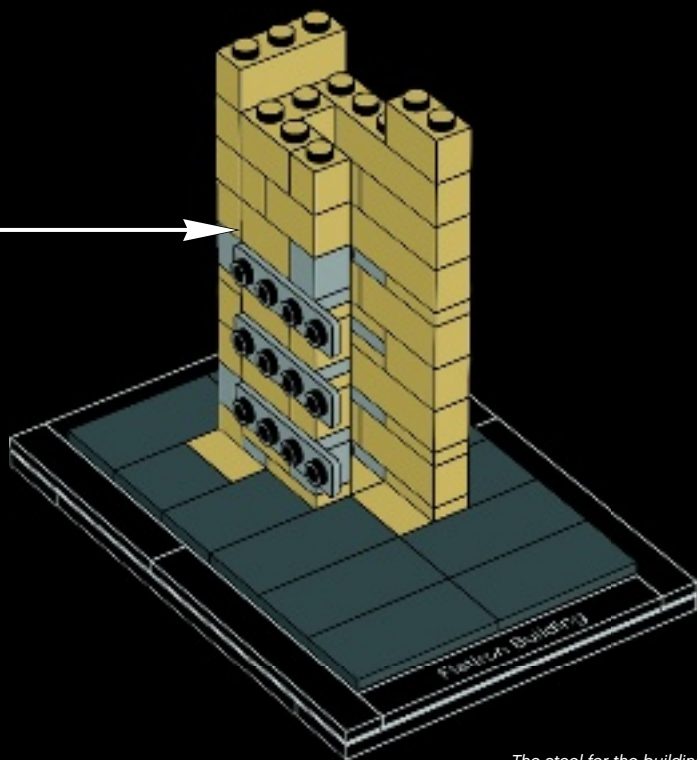

The steel for the building's skeleton frame came from the American Bridge Company mills in Pennsylvania, U.S.

L'acier pour la charpente du bâtiment fut fourni par l'aciérie American Bridge Company en Pennsylvanie, aux États-Unis.

El acero de la estructura del edificio se produjo en las fábricas de American Bridge Company, en Pensilvania (EE. UU.).



©Veronica Mainetti



1x



1x



1x

24

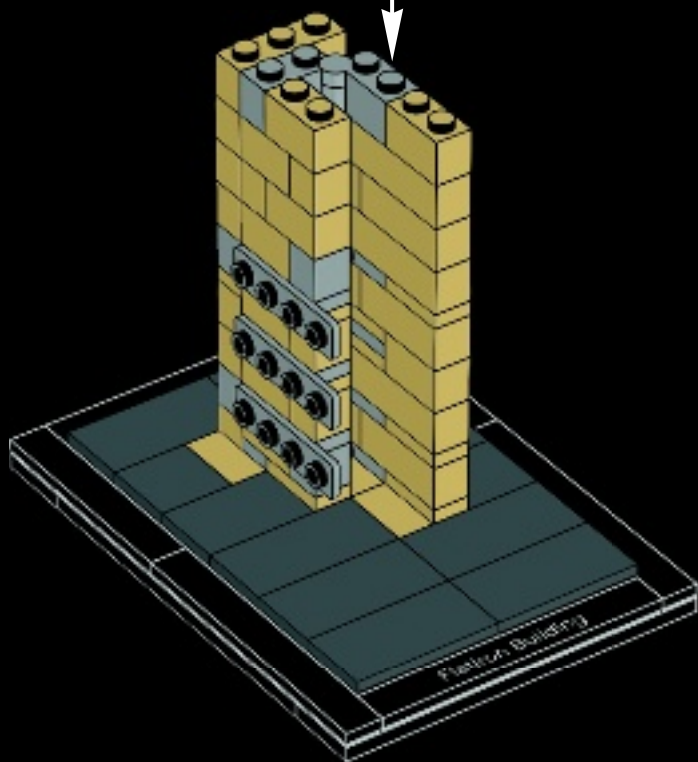
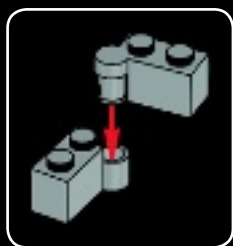



1x



1x



2x



1x



1x

25

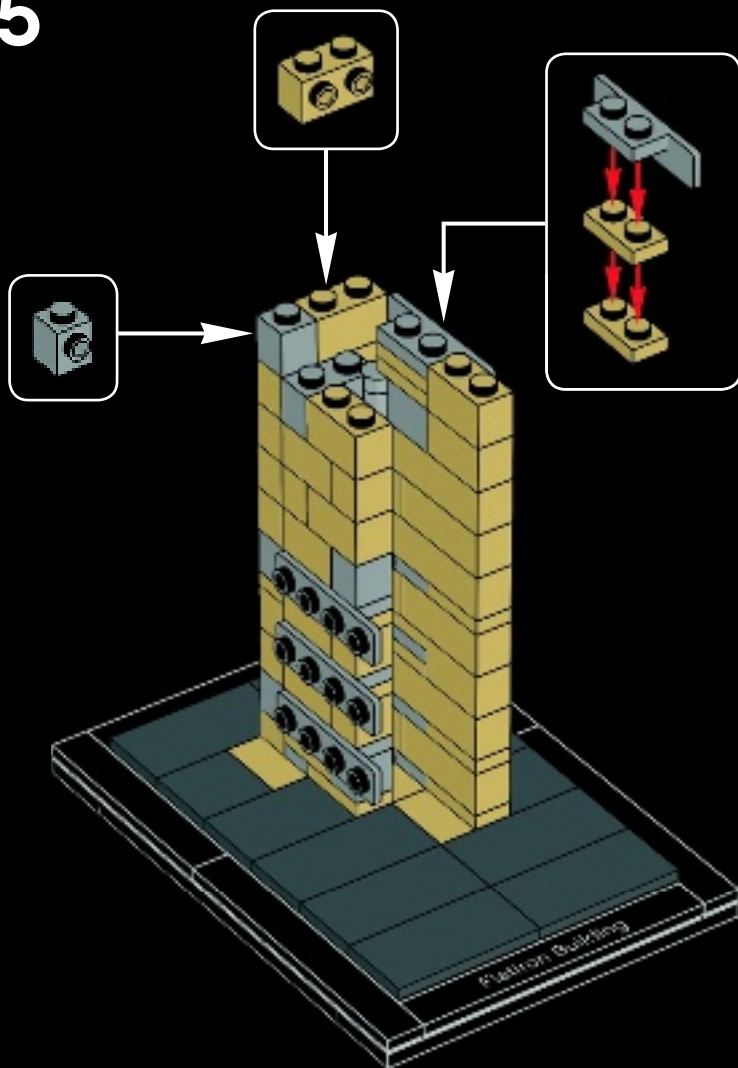



1x



1x

26

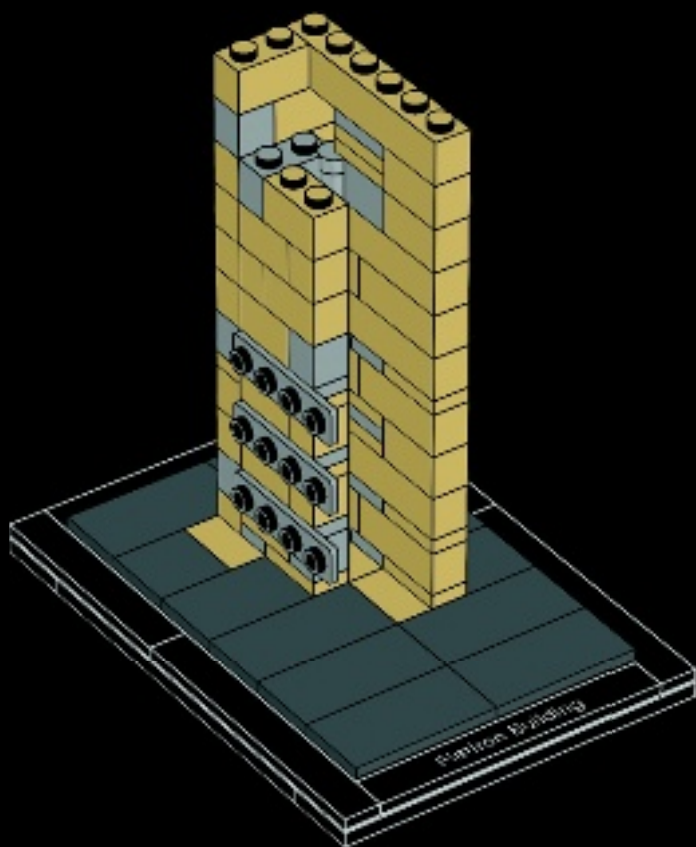



1x



1x



1x

27

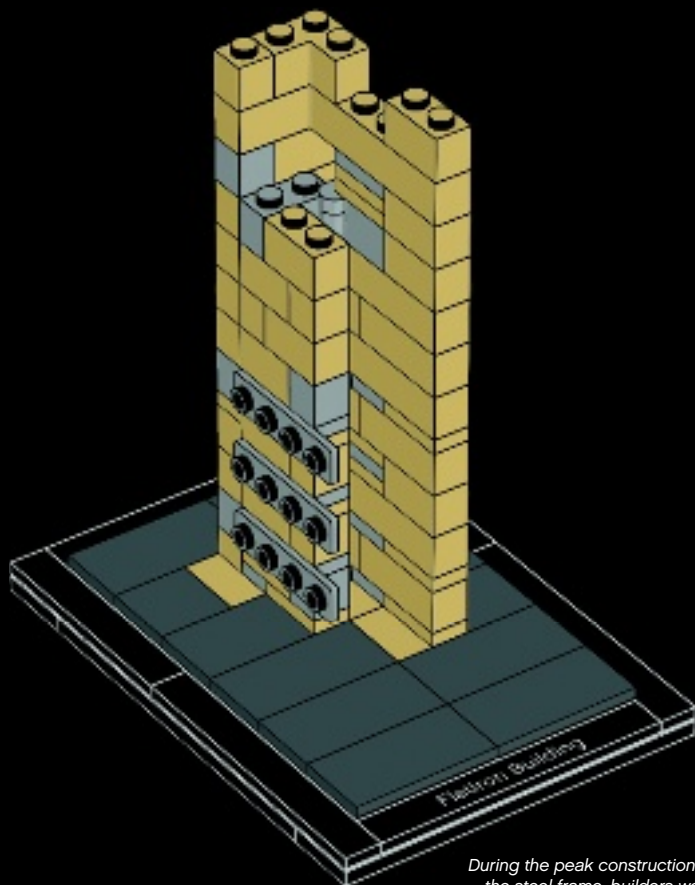

During the peak construction of the steel frame, builders were adding a new story every day.

Au plus fort de la construction de la structure en acier, les ouvriers ajoutaient un nouvel étage chaque jour.

En el momento álgido de la construcción de la estructura de acero, los obreros lograron progresar a una planta por día.



©Veronica Mainetti



2x



1x

28

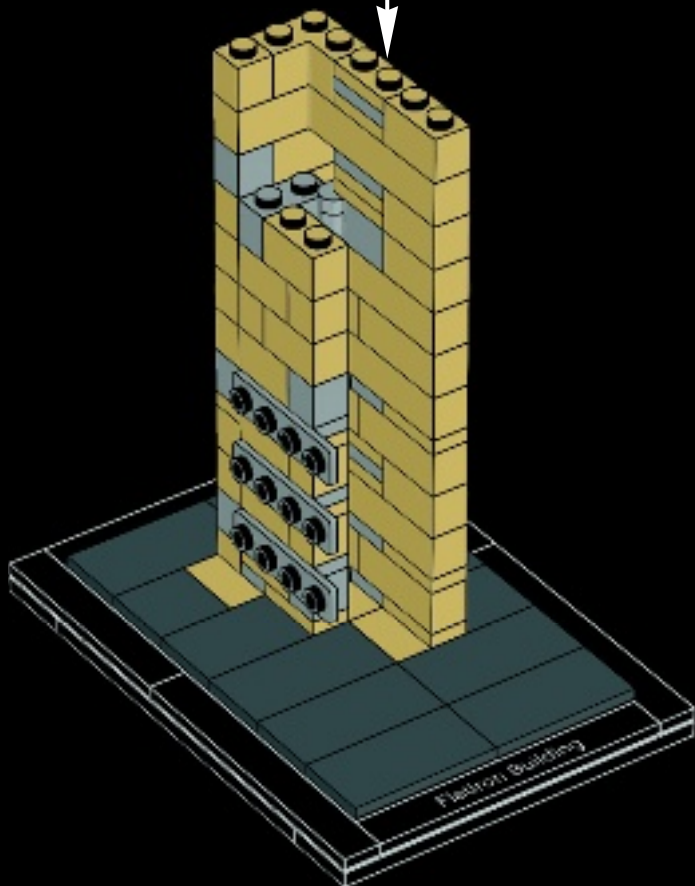
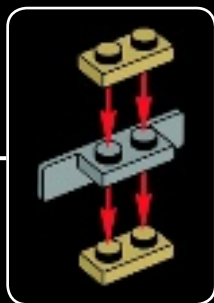



1x



1x



1x

29

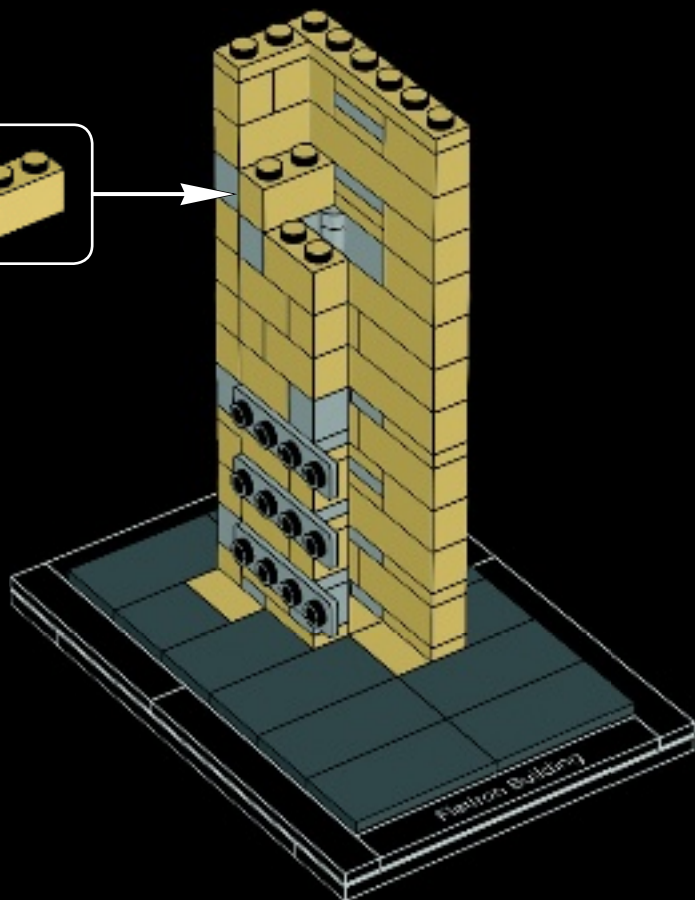



2x



1x

30

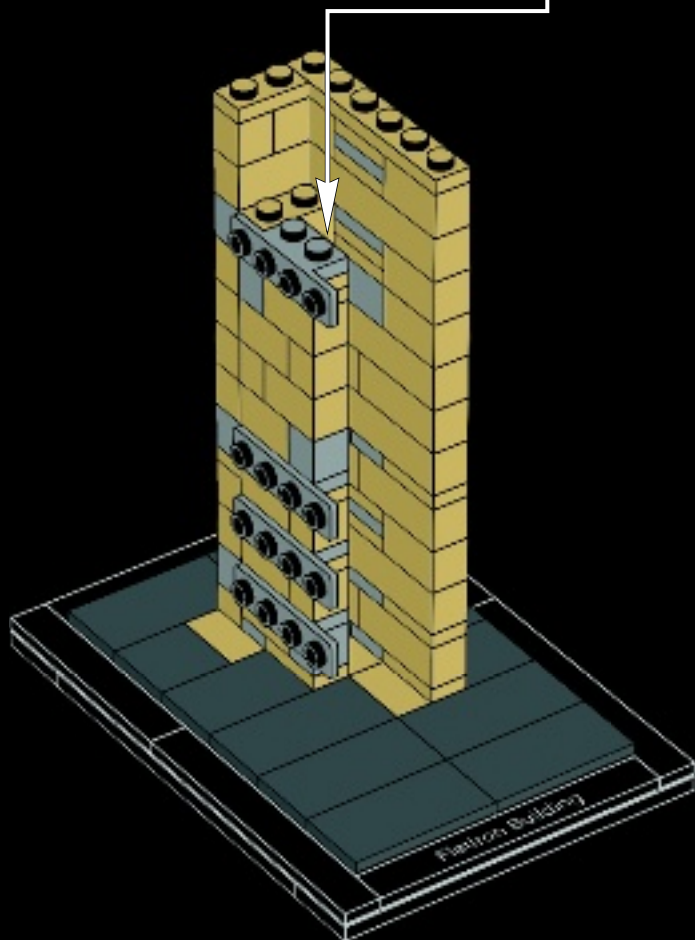
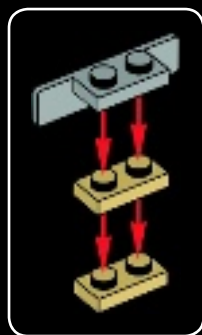

1x



1x



1x



2x



1x



1x



31

1



2



3

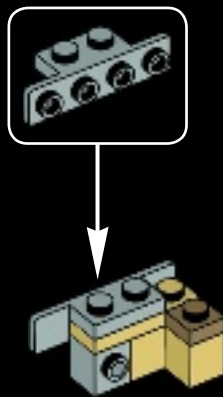

4

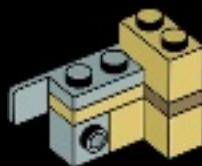

5

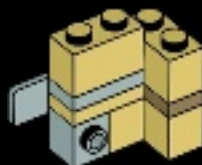

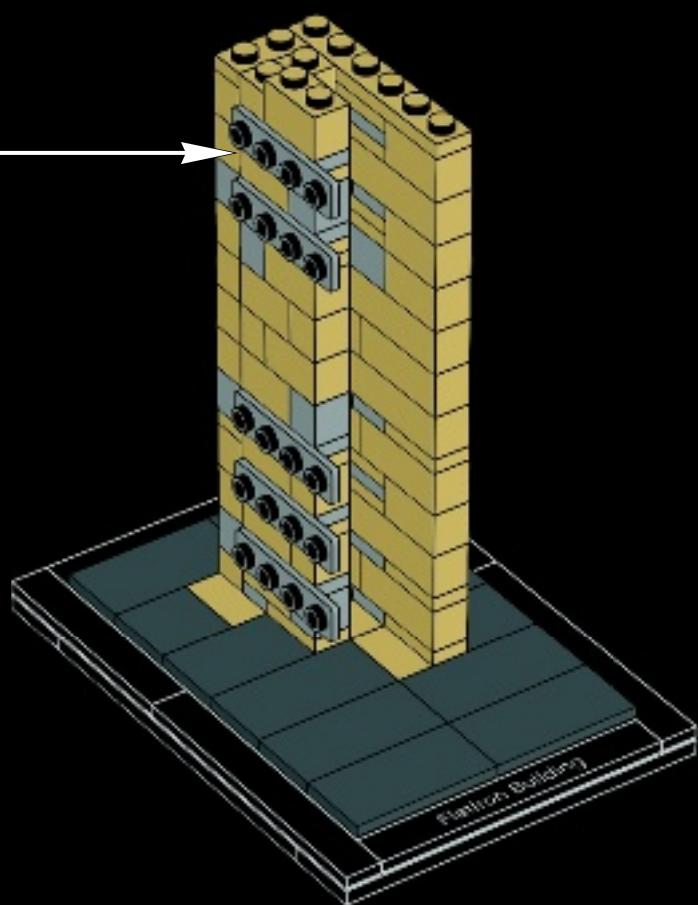



1x



1x



1x

32

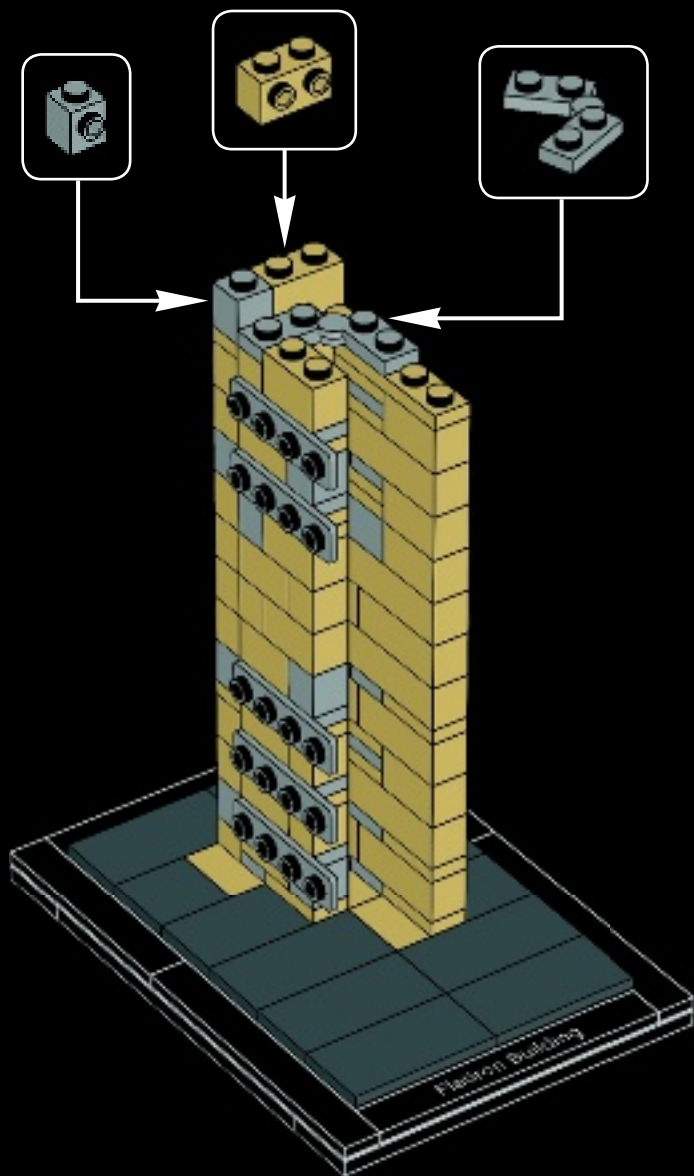



1x



1x

33

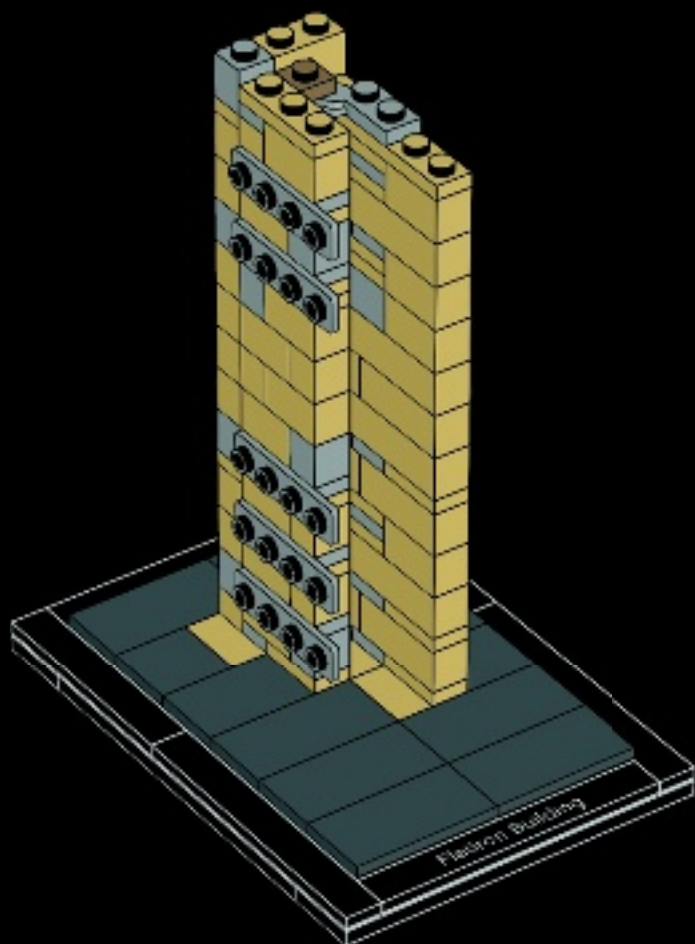



1x



1x



1x

34

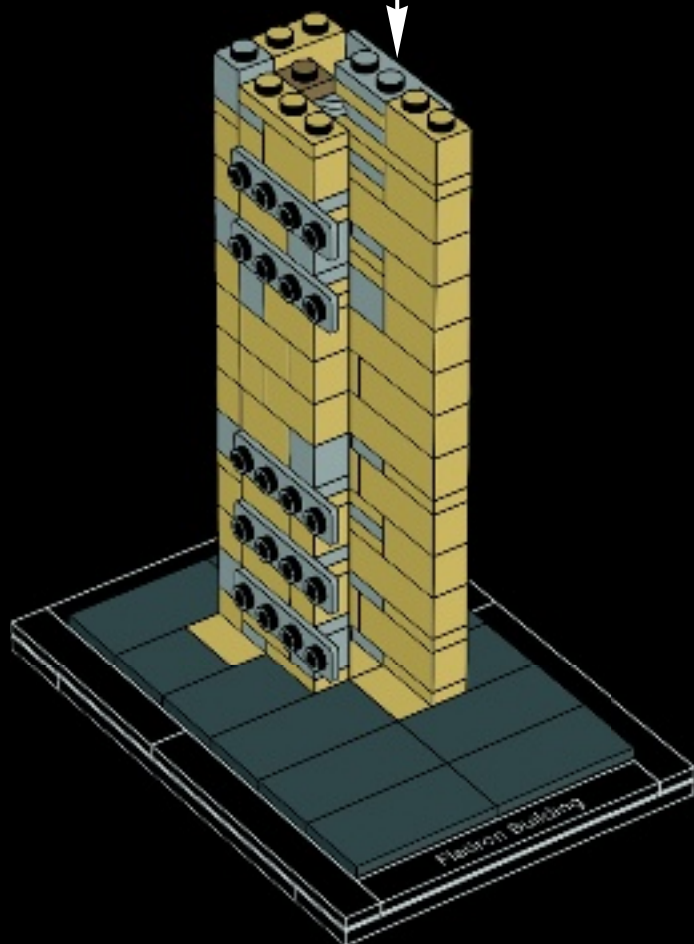
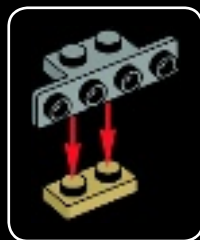



1x



1x

35

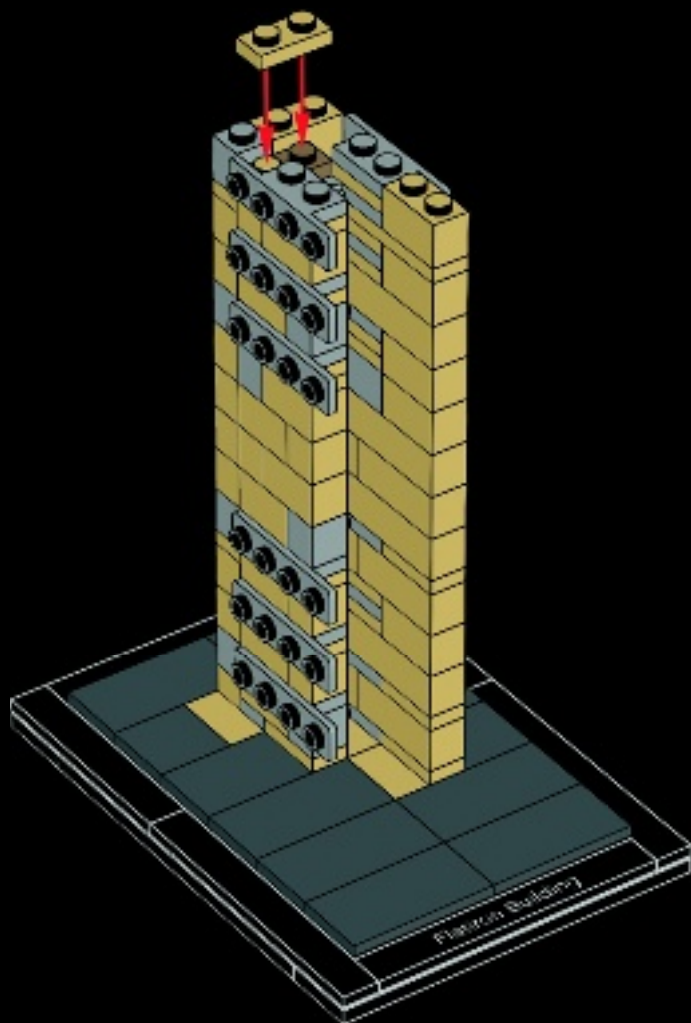



1x



1x

36

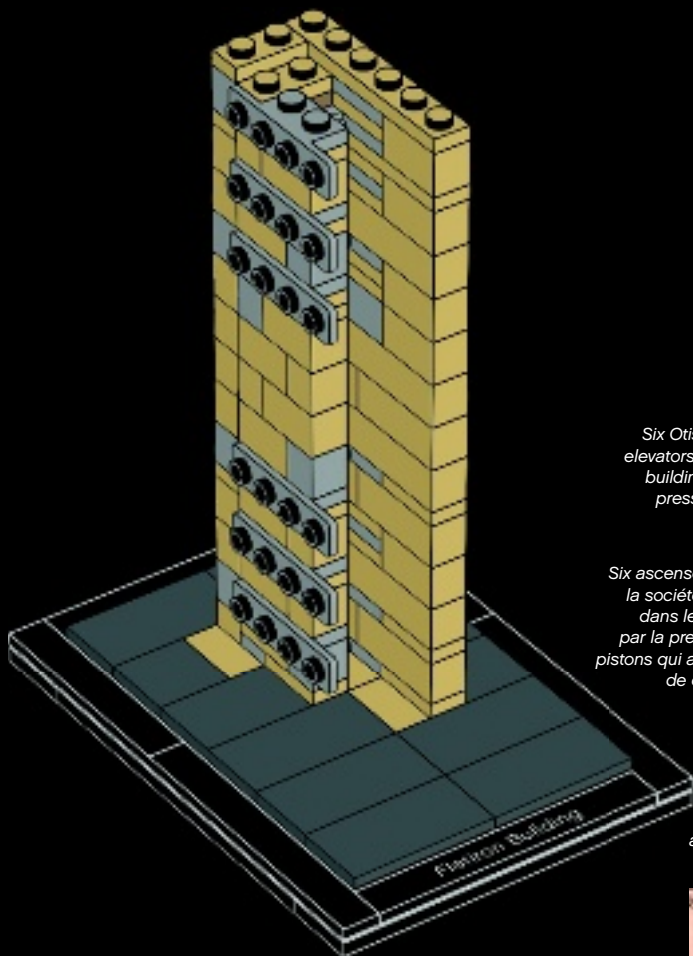

Six Otis Company hydraulic elevators were installed in the building, powered by water pressure and pistons that activated a system of ropes and pulleys.

Six ascenseurs hydrauliques de la société Otis furent installés dans le bâtiment, actionnés par la pression de l'eau et des pistons qui activaient un système de cordes et de poulies.

Otis Company equipó el edificio con seis elevadores alimentados por presión hidráulica y pistones que activaban un sistema de cables y poleas.



© Wikipedia



1x



1x

37

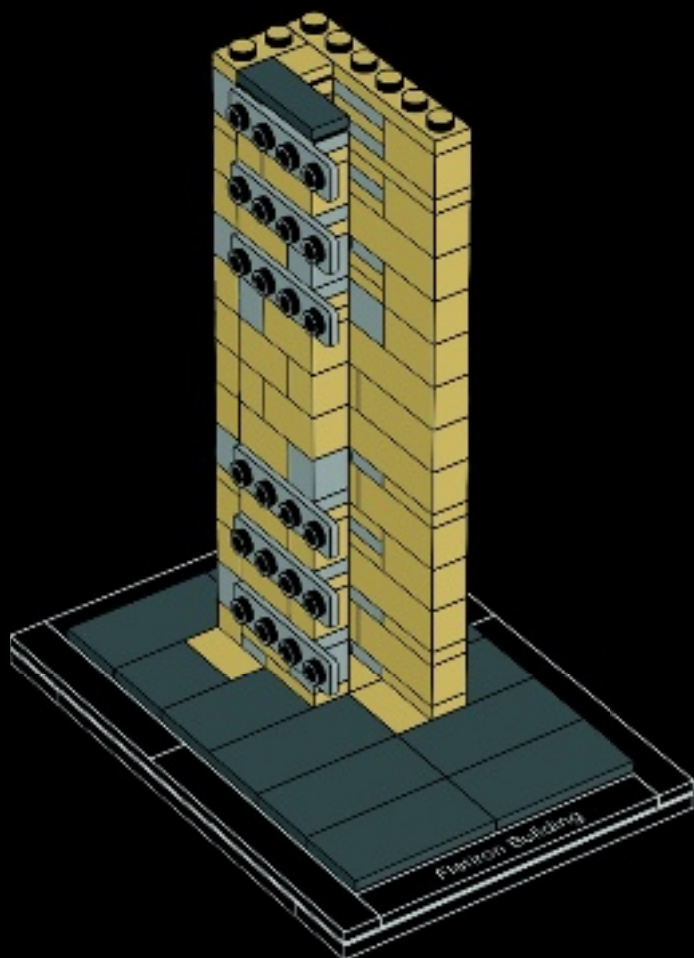



2x

38

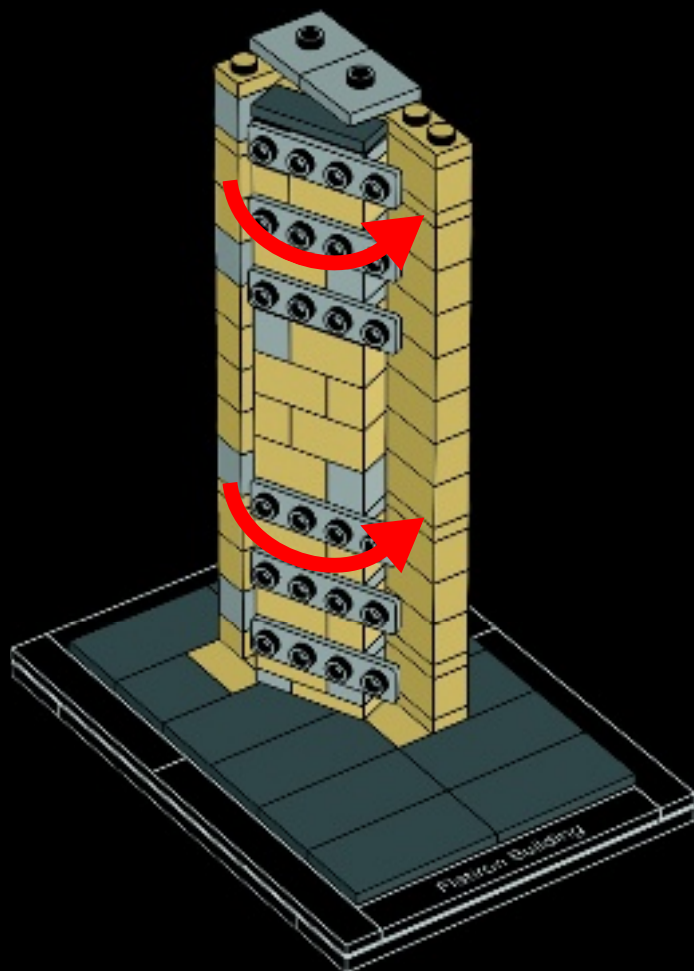

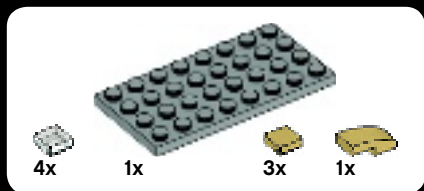

1

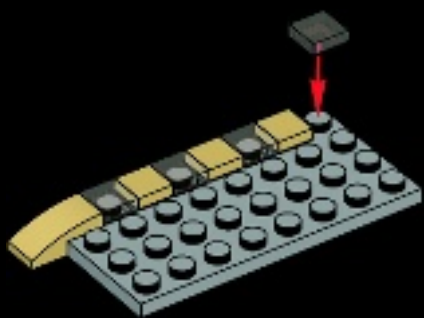

2

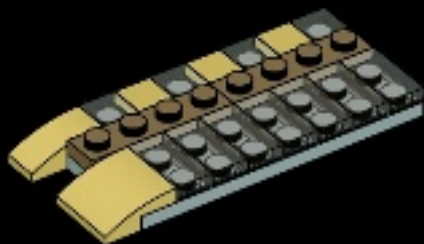

3

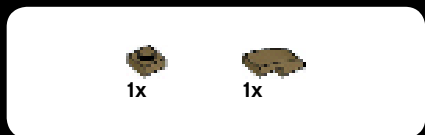

4

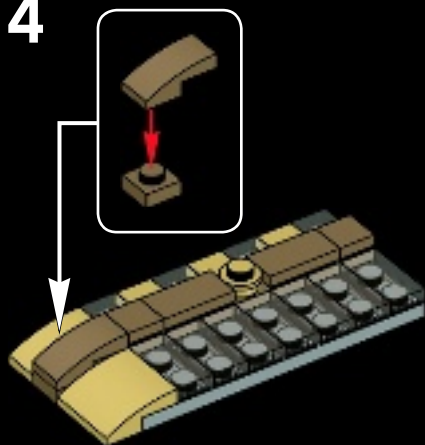

39

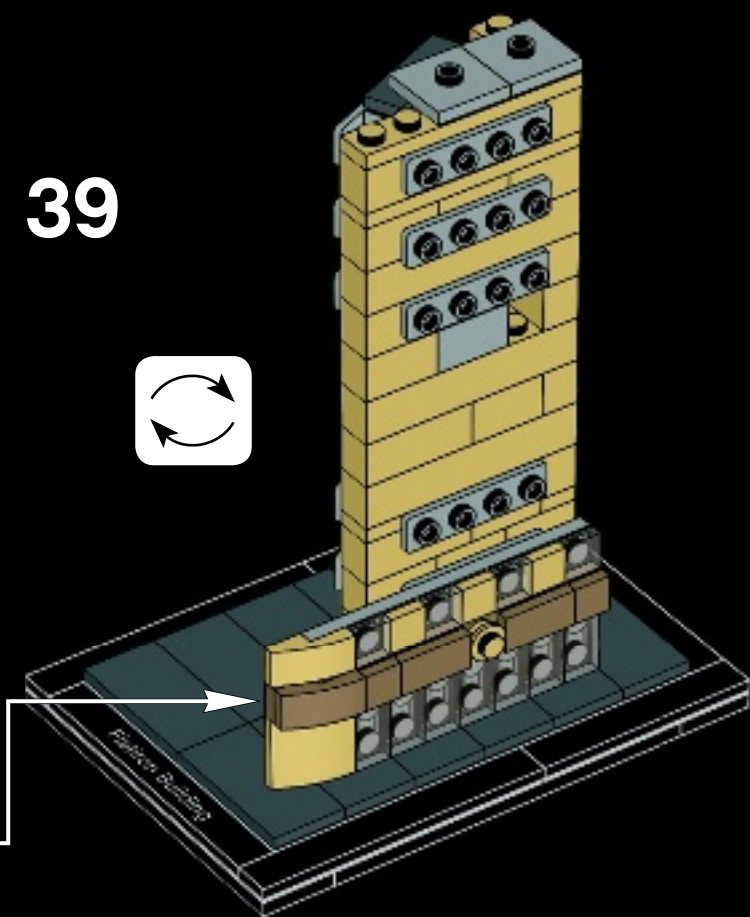

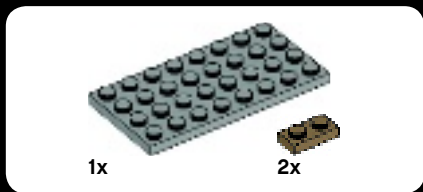

1

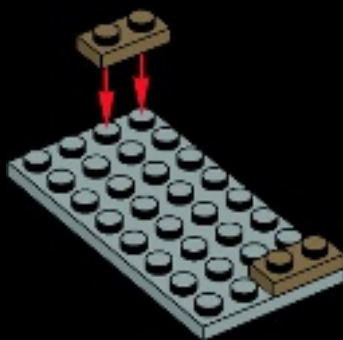

2

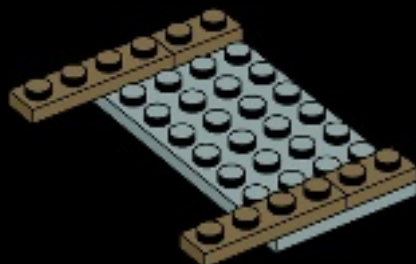



1x

3



6x



2x

4



The windows are deliberately small in size to ensure the building appears even more substantial.

Les fenêtres sont délibérément de taille réduite afin que le bâtiment paraisse encore plus monumental.

Las ventanas se hicieron pequeñas deliberadamente para que el edificio pareciera aún más robusto.

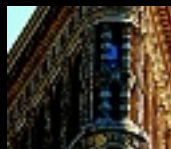

©Veronica Meinert



3x



12x

5

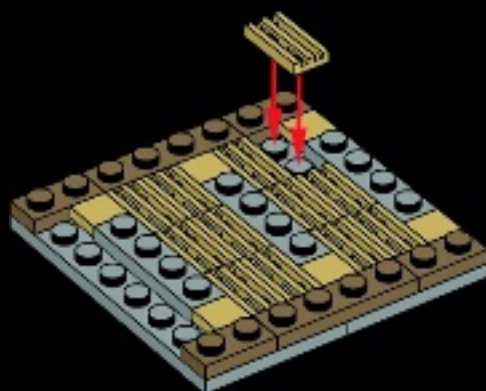

6x



3x

6

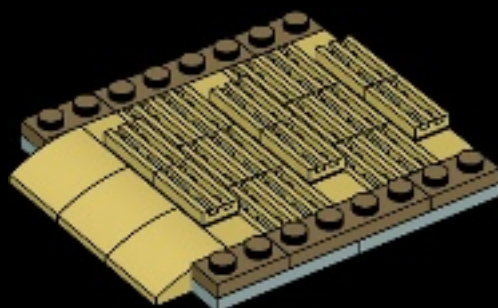



6x



4x

7

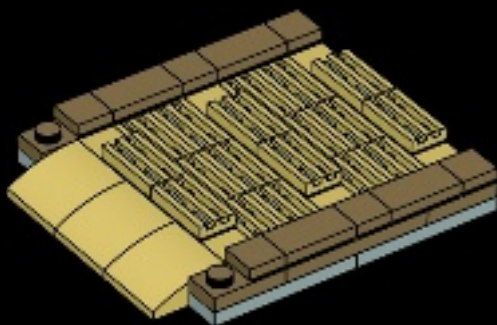

2x



2x

8

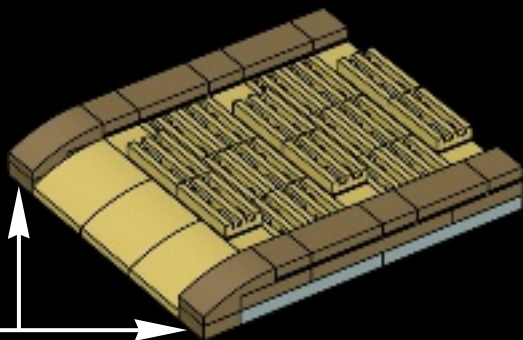

40

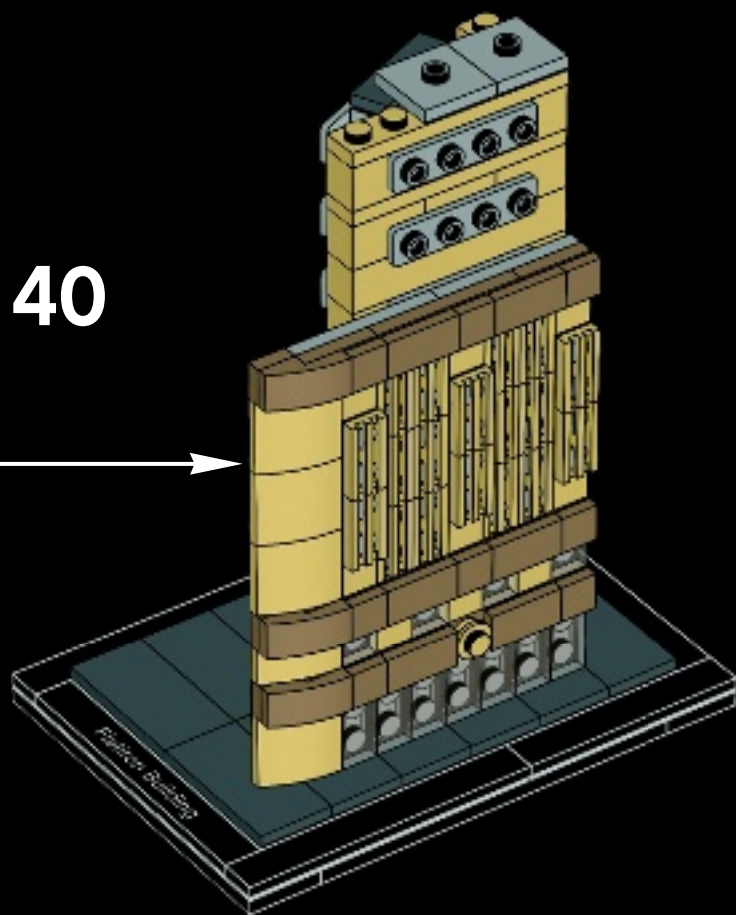

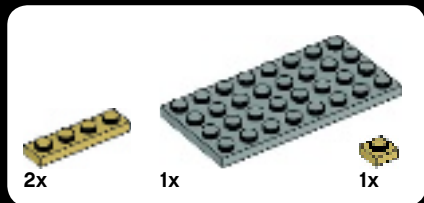

1

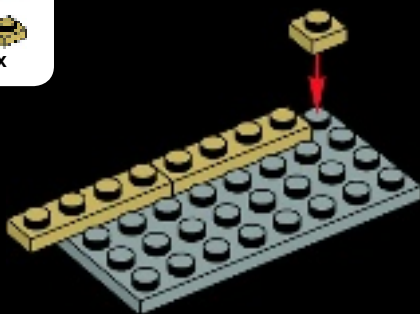

2



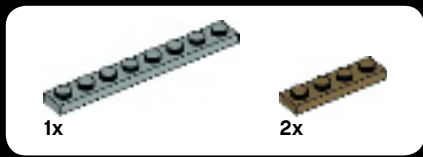

3

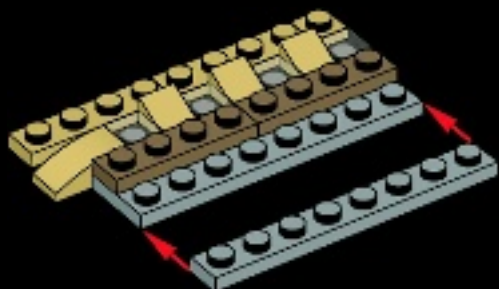

4

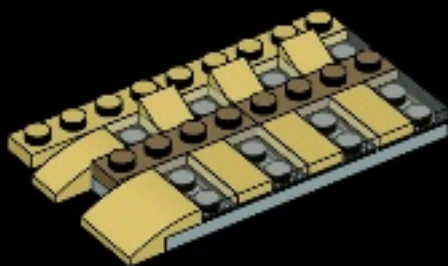



4x



1x



3x



1x



2x



1x

5

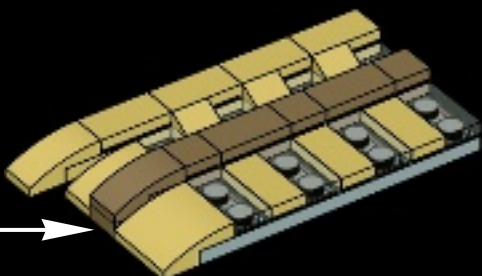

1x

6

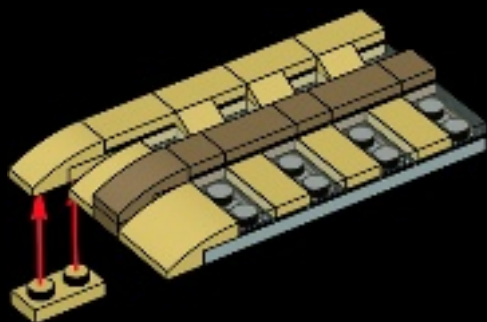

41

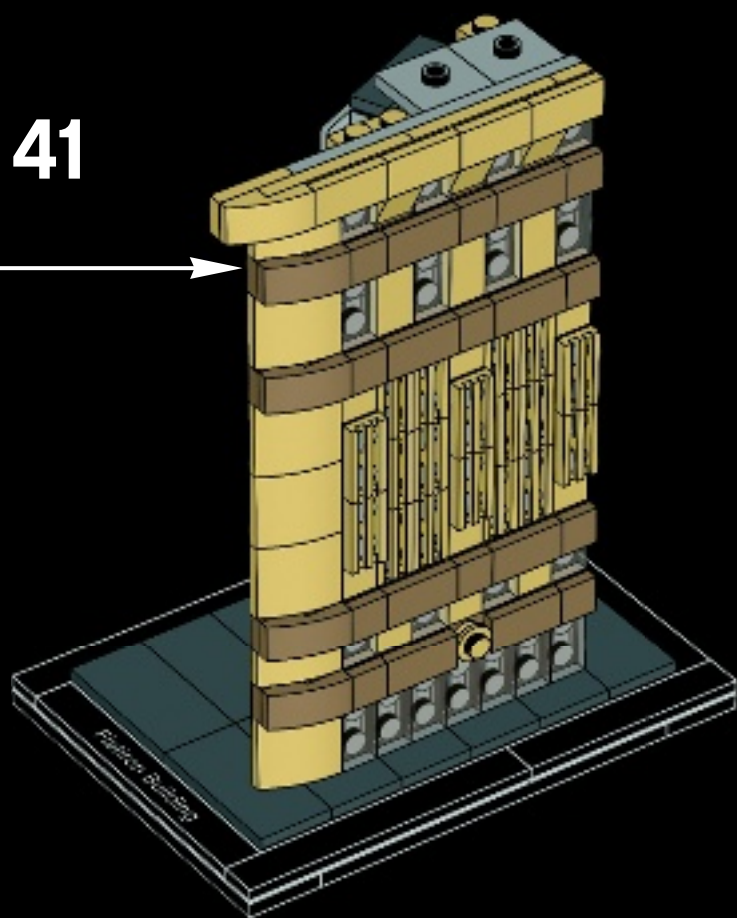



1x

1

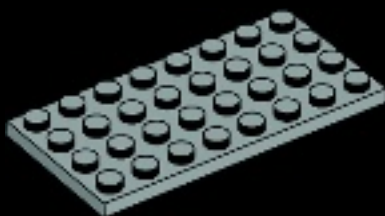

2x

2x

2x

2x

4x

2

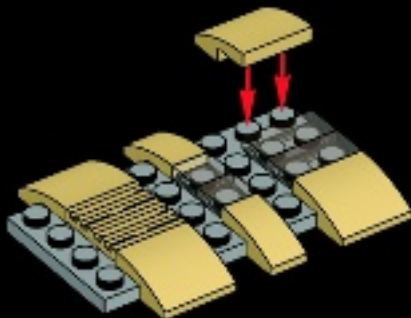

The façade includes many Italian and French Renaissance motifs, such as Greek faces and terracotta flowers.

La façade inclut de nombreux motifs de la Renaissance italienne et française, notamment des visages grecs et des fleurs en terre cuite.

La fachada incluye numerosos elementos decorativos inspirados en el Renacimiento italiano y francés, como los rostros griegos y las flores de terracota.



©Veronica Meinert



2x



2x

3

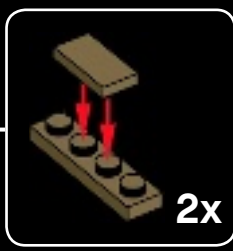
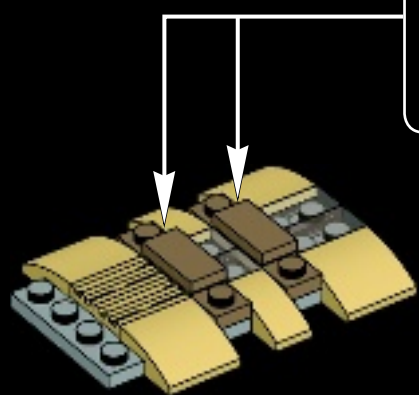

4x



4x

4

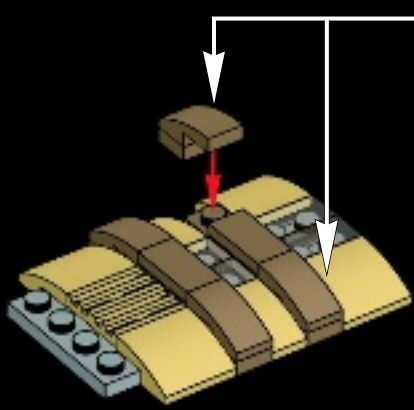



1x

5

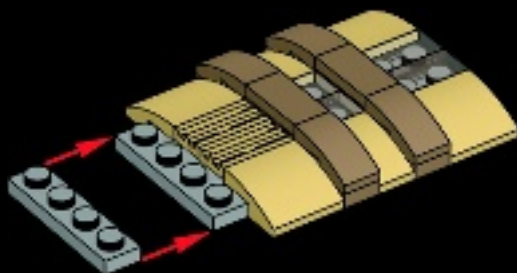

2x



2x

6

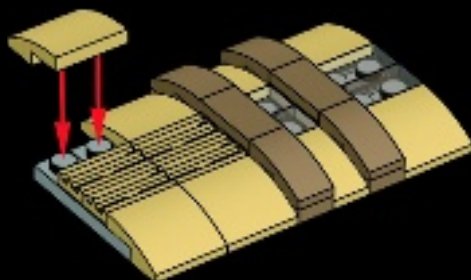

42

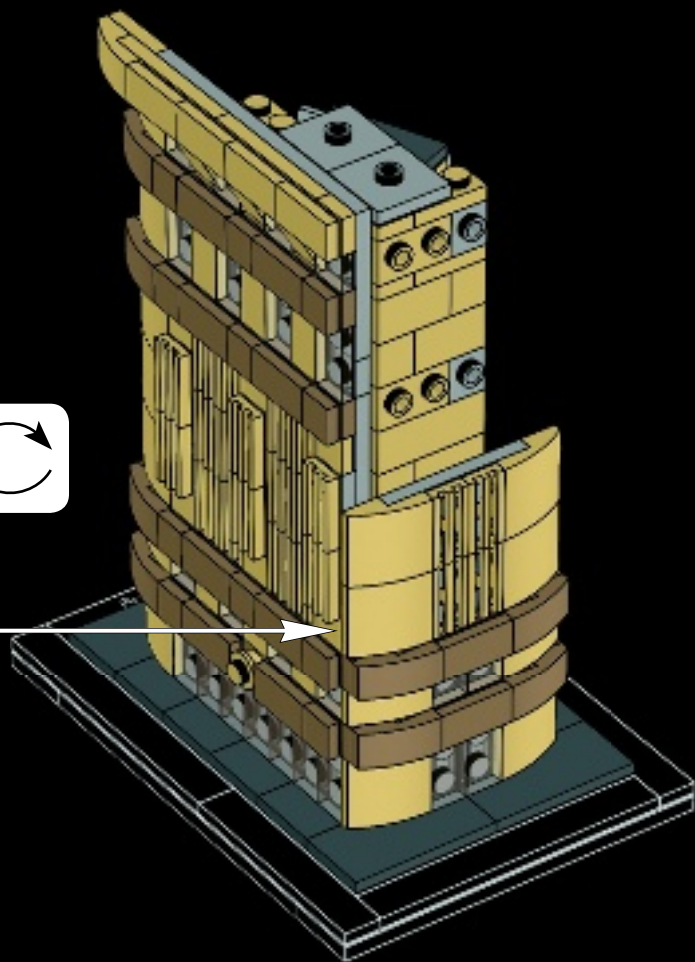

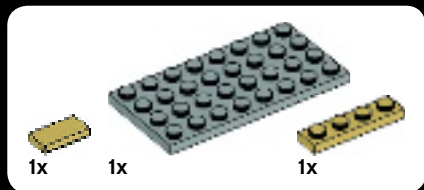

1



2

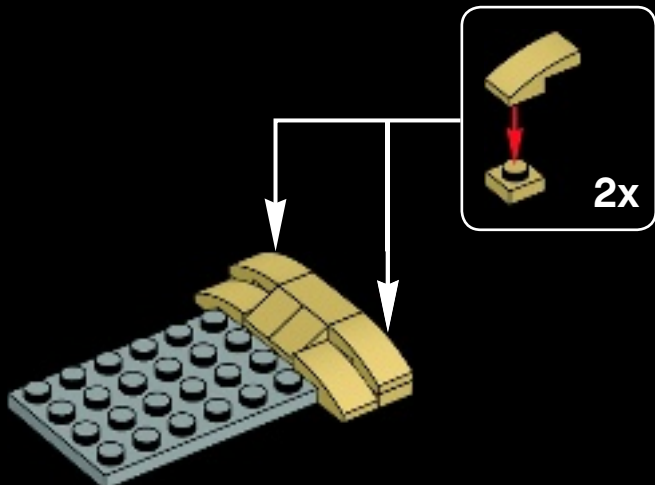



2x



2x



4x

3

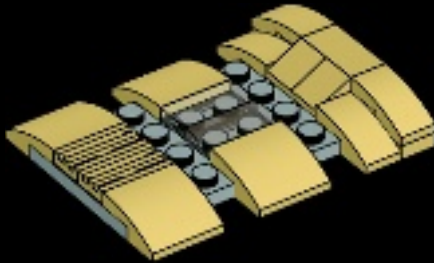

2x



2x

4

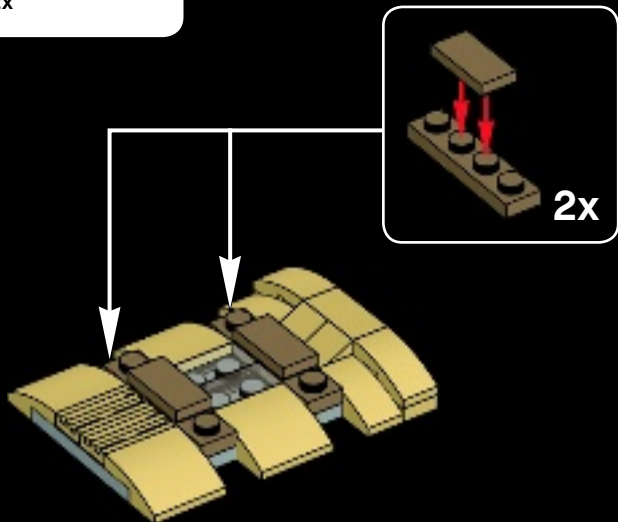



4x



4x

5

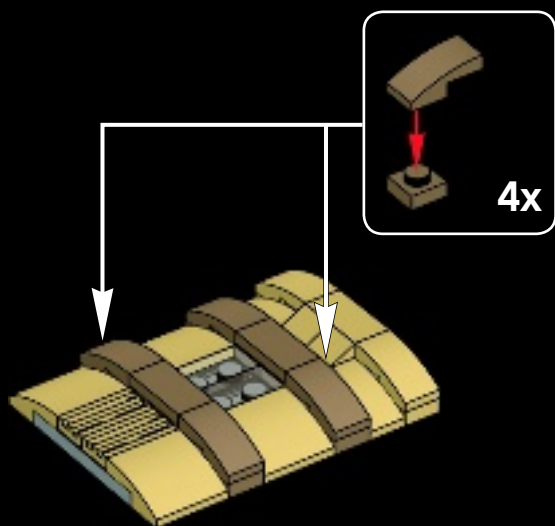

43



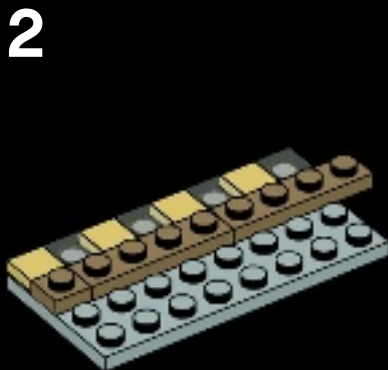
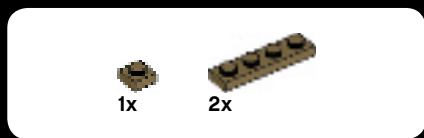
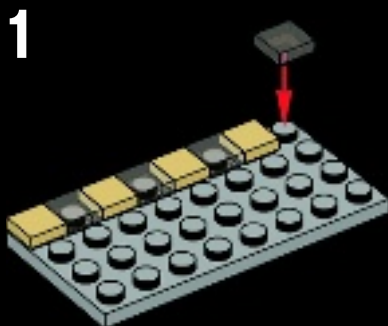

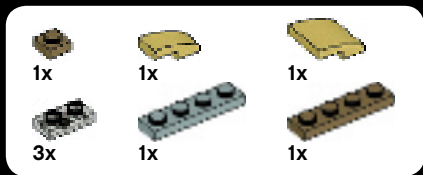

5

1



2



3

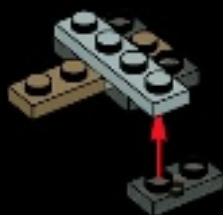

4



5



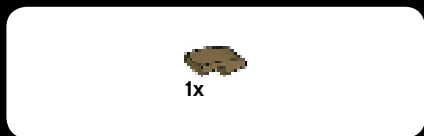
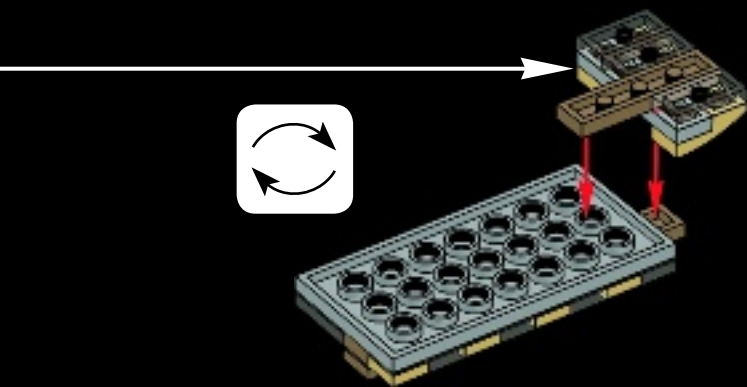

6

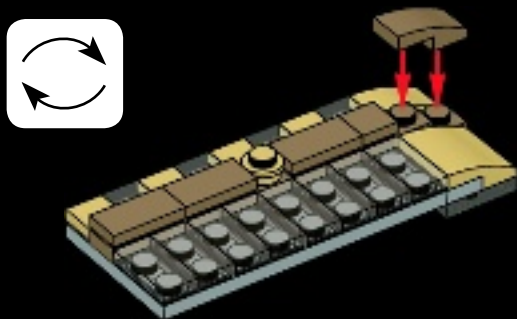

44

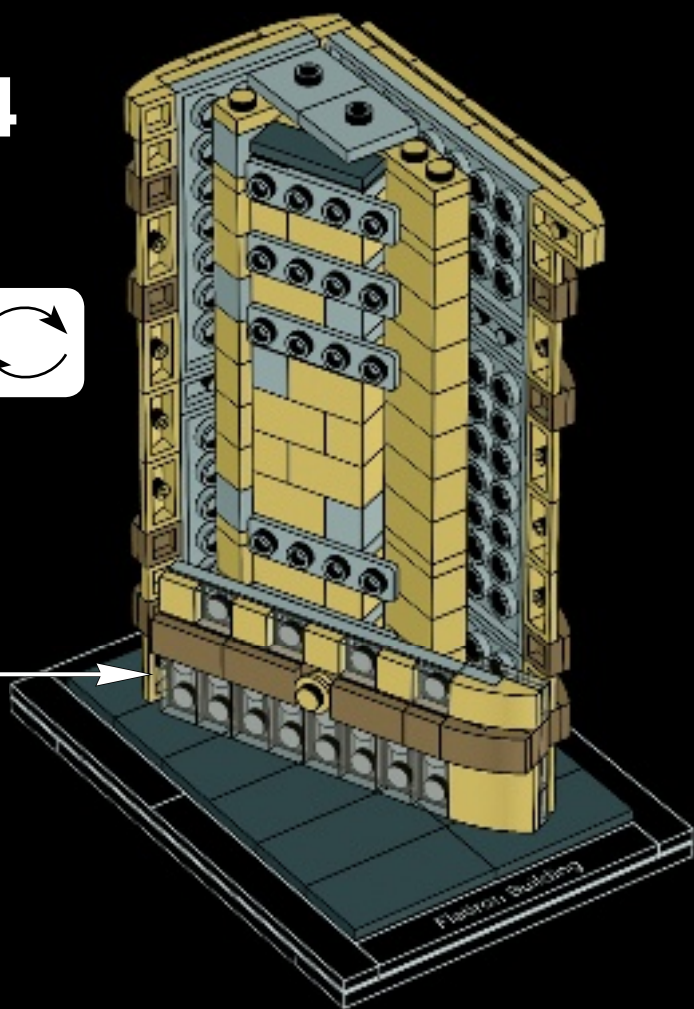



1



2





1x

3



2x



2x

4

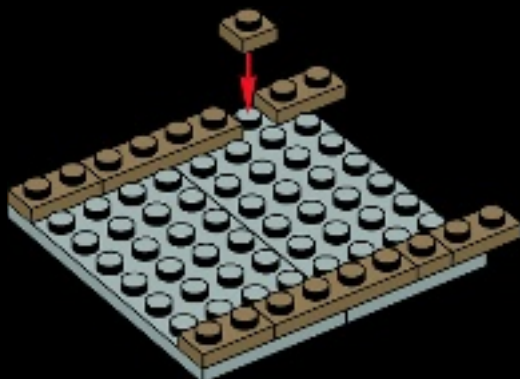



6x



3x

5



15x

6

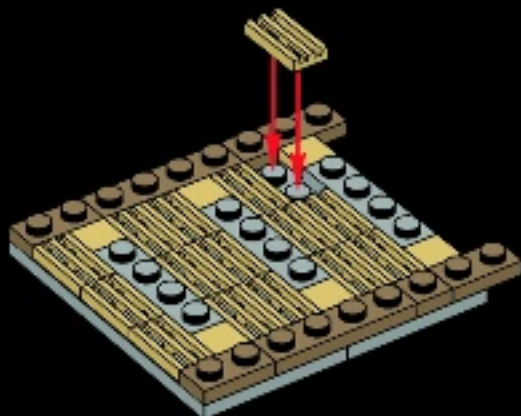



8x

7

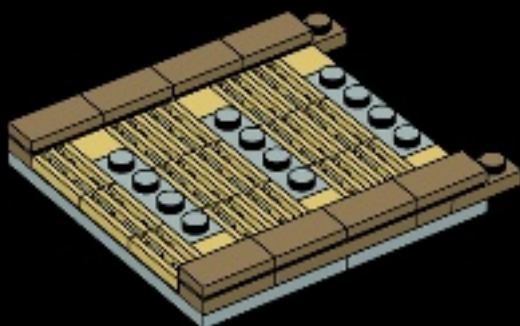

6x

8

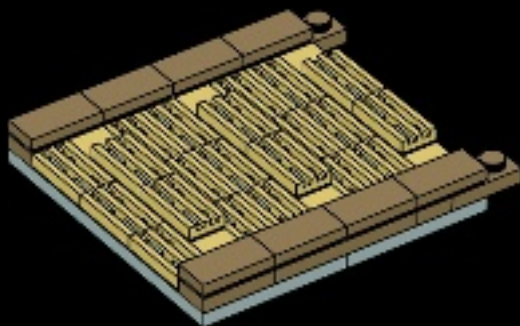

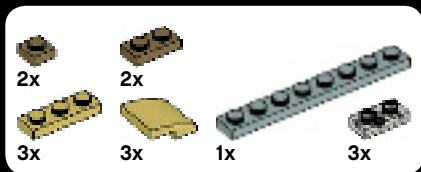

9

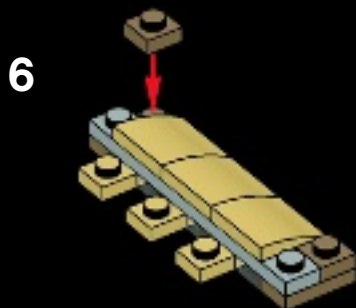
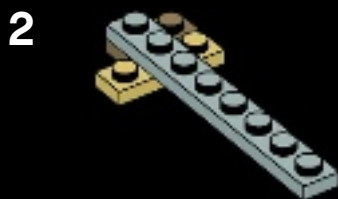

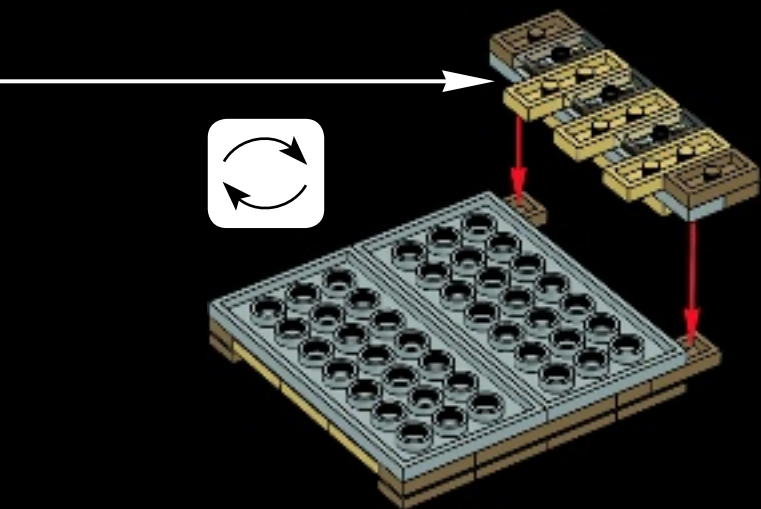

10

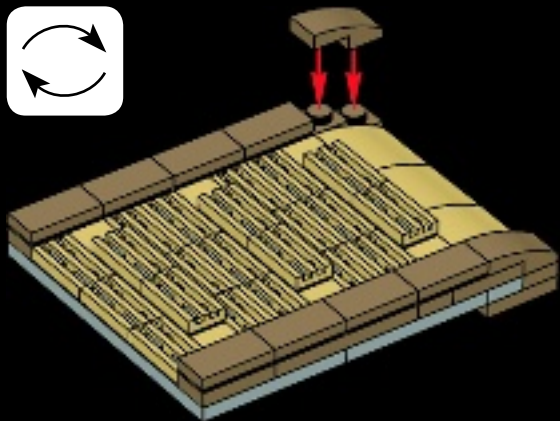

45

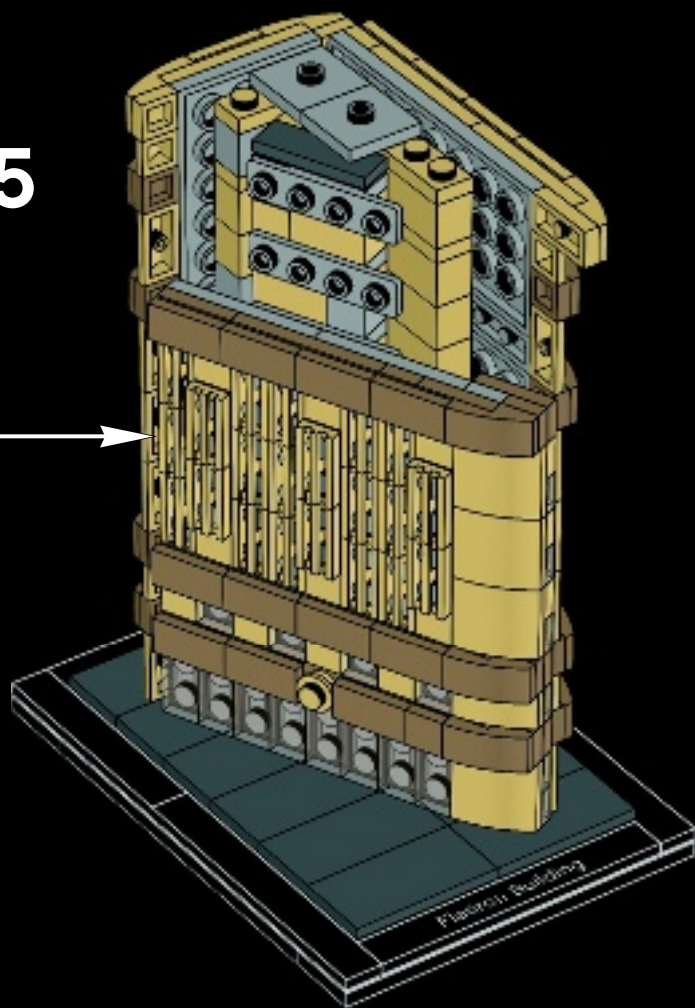

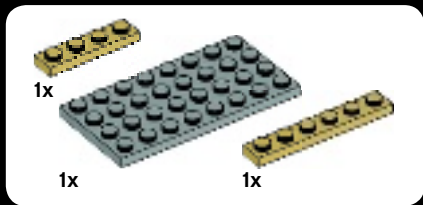

1

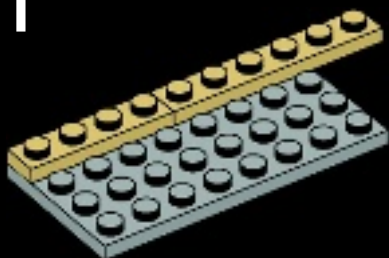

2

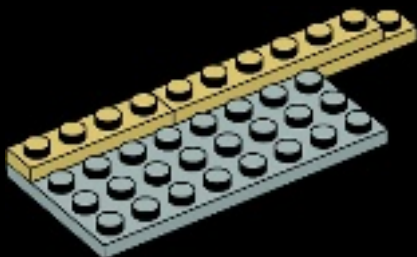

3

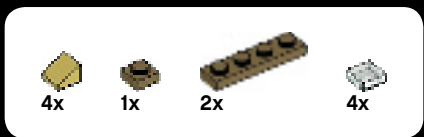
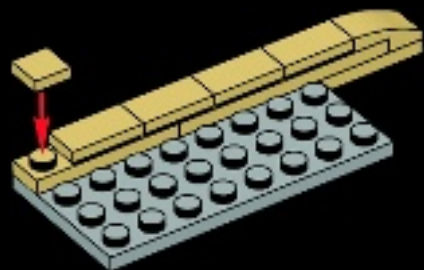

4

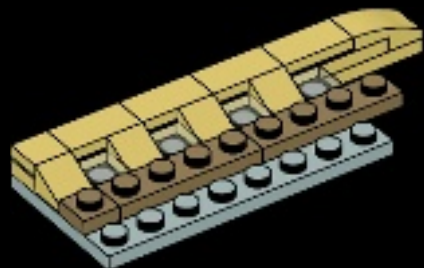

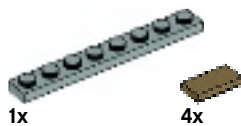

1x

4x

5

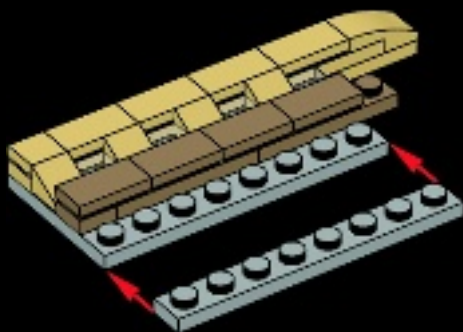

4x



4x

6

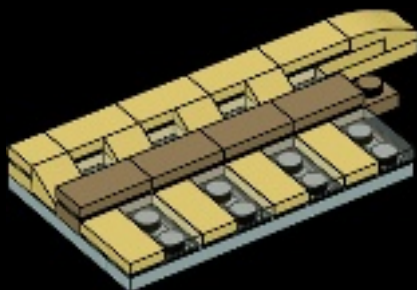



7

1



2



3

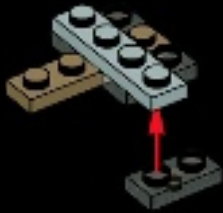

4



5



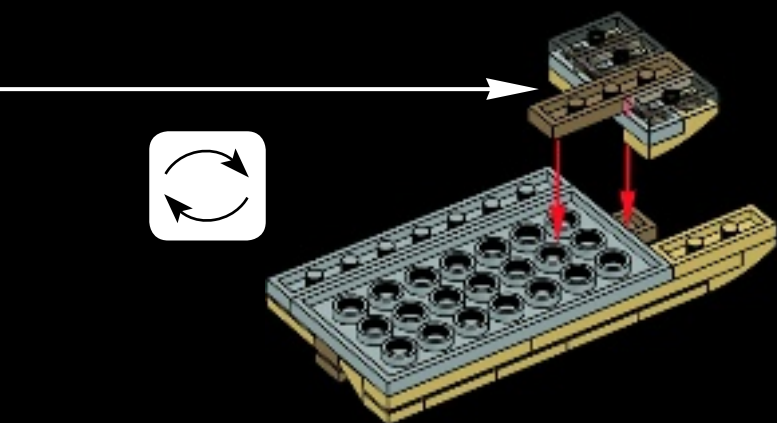

8

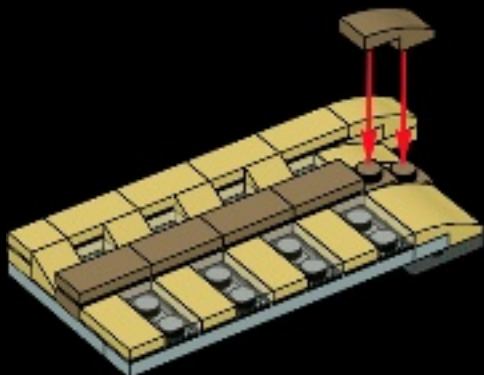

46

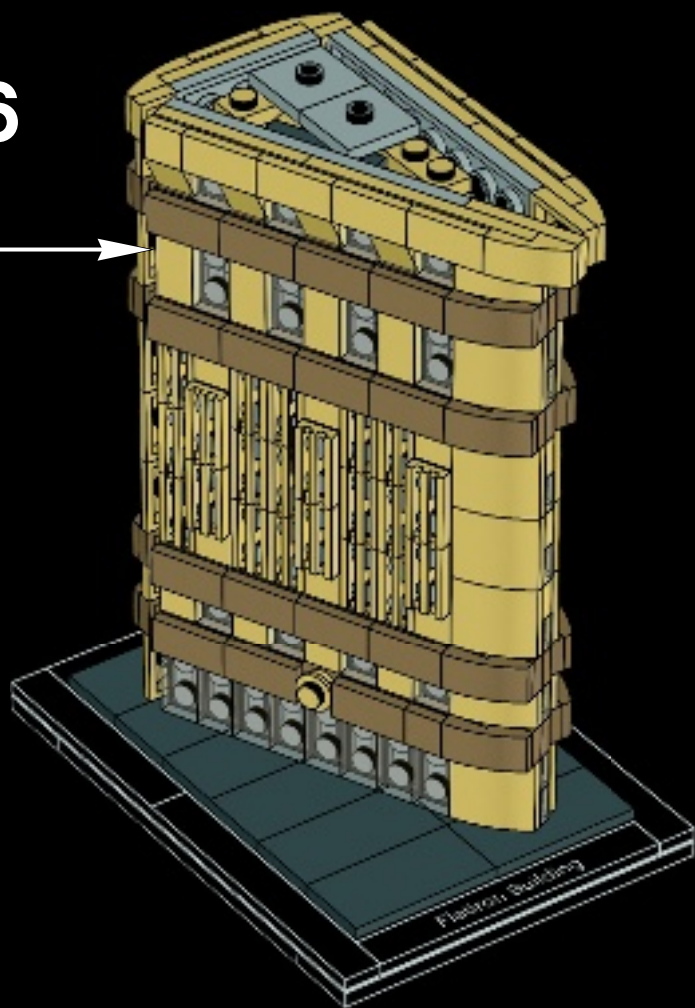



1

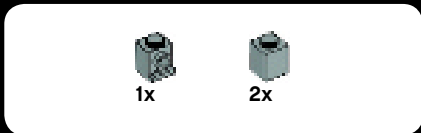
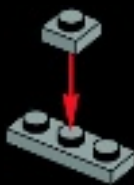

2

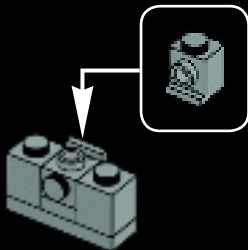

3

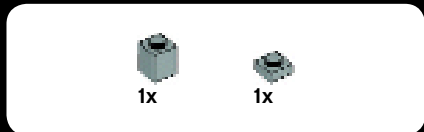
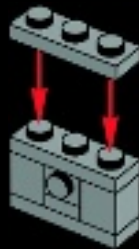

4

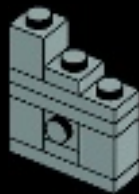

5

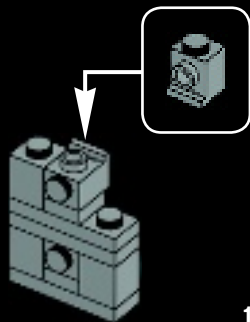



1x

6

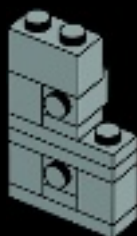

1x



1x

7

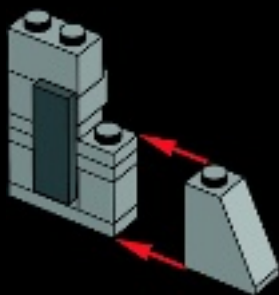

1x

8

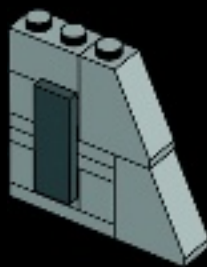

2x



1x

9

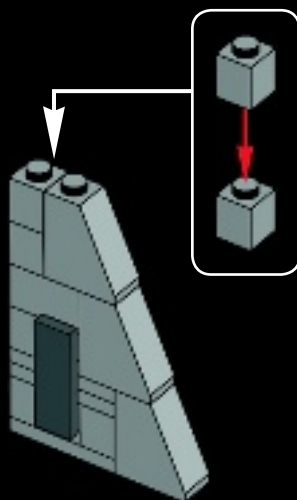



1x



1x

10

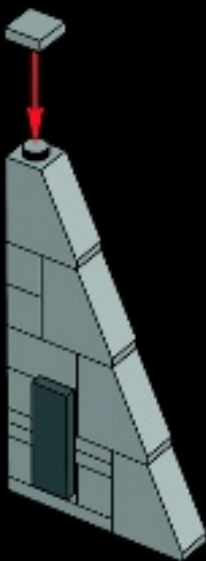

1x

11

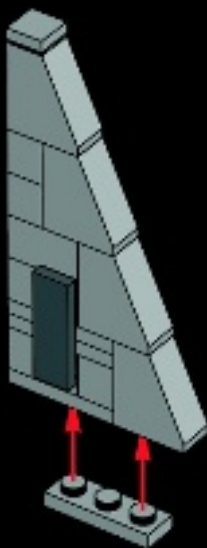

The upper floor originally housed a restaurant and an observation deck, both now closed.

L'étage supérieur abritait à l'origine un restaurant et un site d'observation, mais les deux sont maintenant fermés.

Al principio, la planta superior albergaba un restaurante y una plataforma de observación, ambos cerrados en la actualidad.



©Veronica Mainetti

47

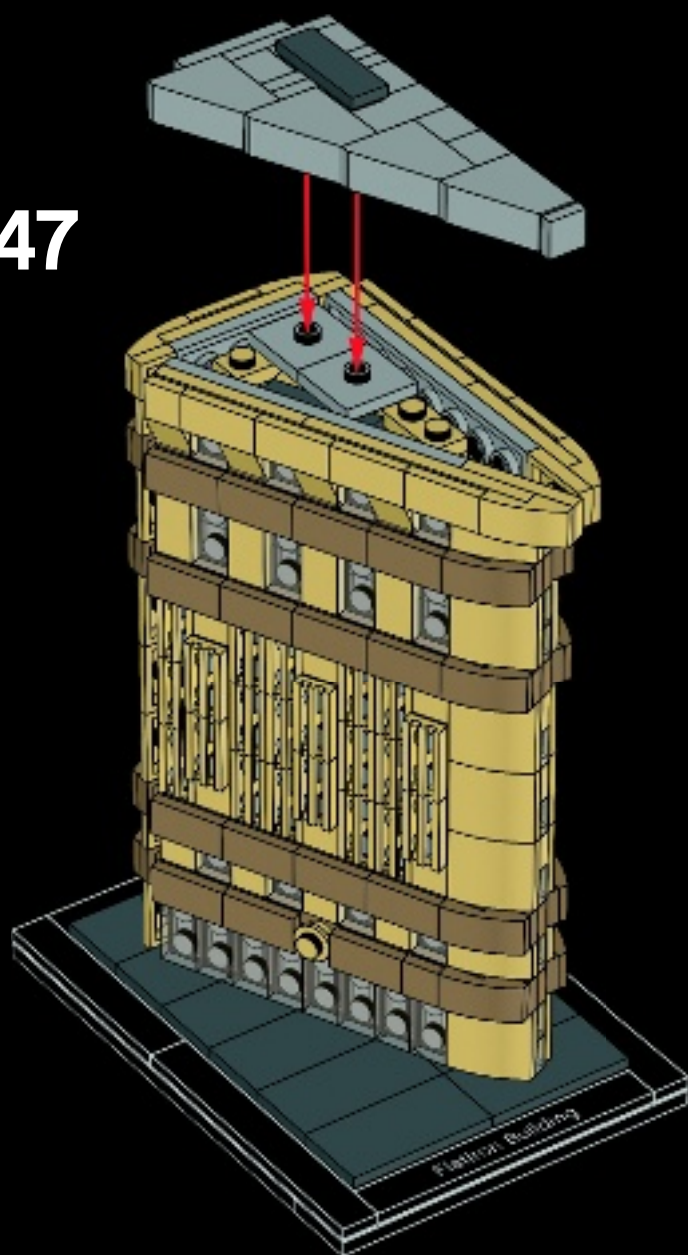

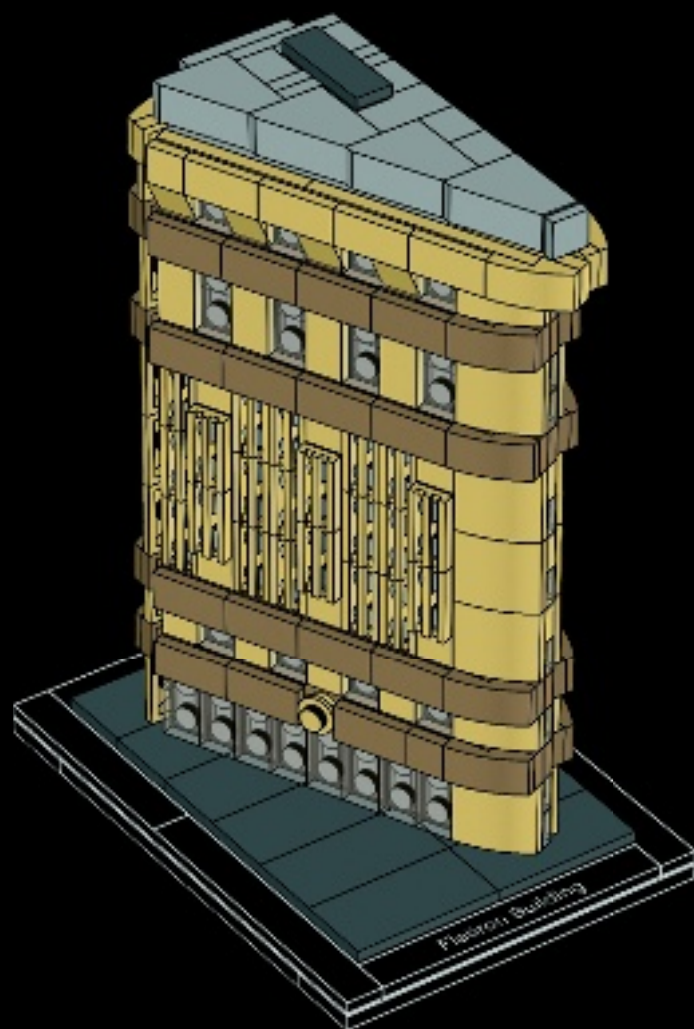

LEGO® Architecture – Then and Now

There has always been a natural connection between the LEGO® brick and the world of architecture. Fans who build with LEGO elements instinctively develop an interest in the form and function of the structures they create. At the same time, many architects have discovered that LEGO bricks are the perfect way of physically expressing their creative ideas.

This connection was confirmed in the early 1960s with the launch of the LEGO “Scale Model” line. It matched the spirit of the age where modern architects were redefining how houses look and people were taking an active interest in the design of their new homes. These sets were designed to be different from the normal, brightly colored LEGO boxes; they also included a book on architecture as a source of inspiration.



21050
LEGO Architecture Studio



Decades later, architect and LEGO fan Adam Reed Tucker revived the idea of expressing architecture using LEGO bricks and in partnership with the LEGO Group, launched the LEGO Architecture line that we know today. His first models, and the original sets in the current LEGO Architecture series, were interpretations of famous skyscrapers from his hometown of Chicago. Since then LEGO Architecture has developed and evolved, first with well-known buildings from other cities in the United States, and now with iconic structures from Europe, the Middle East, and Asia.

The introduction of our LEGO Architecture Studio set echoes the ambitions of the earlier LEGO “Scale Model” line and widens the potential of the LEGO Architecture series. Now you can enjoy building and learning about specific landmark buildings, or create exciting architectural models from your own fantasy. An inspiring 270-page book, featuring a number of renowned architects from around the world, guides you through the principles of architecture and encourages you in your own creative building.

LEGO® Architecture

– Hier et aujourd'hui

Il y a toujours eu une connexion naturelle entre la brique LEGO® et le monde de l'architecture. Les fans qui construisent avec des éléments LEGO développent instinctivement un intérêt pour la forme et la fonction des structures qu'ils créent. De nombreux architectes ont quant à eux découvert que les briques LEGO sont la façon idéale d'exprimer physiquement leurs idées de création.

Cette connexion a été confirmée au début des années 1960 avec le lancement de la gamme « Maquettes à l'échelle » LEGO. Elle correspondait à l'esprit de l'époque, alors que les architectes modernes redéfinissaient les maisons, et que les gens s'intéressaient activement à la conception de la maison de leurs rêves. Ces ensembles originaux étaient conçus pour être différents des boîtes LEGO habituelles aux couleurs vives, et incluaient aussi « un livret d'architecture » comme source d'inspiration.

Des décennies plus tard, l'architecte et fan LEGO Adam Reed Tucker a fait revivre l'idée d'exprimer l'architecture en utilisant des briques LEGO. En partenariat avec le Groupe LEGO, il lança la gamme LEGO Architecture que nous connaissons aujourd'hui. Ses premiers modèles, et les modèles originaux dans la gamme LEGO Architecture actuelle, étaient des interprétations de célèbres gratte-ciel de sa ville natale de Chicago. La gamme LEGO Architecture a depuis évolué et s'est transformée, tout d'abord avec des bâtiments célèbres d'autres villes des États-Unis et maintenant avec de célèbres structures d'Europe, du Moyen-Orient et d'Asie.

L'introduction de notre ensemble LEGO Architecture Studio fait écho aux ambitions de la précédente gamme « Maquettes à l'échelle » LEGO et élargit le potentiel de la gamme LEGO Architecture. Vous pouvez maintenant apprécier et découvrir des bâtiments historiques ou créer de passionnants modèles architecturaux nés de votre imagination. Un livre d'inspiration de 270 pages, présentant plusieurs architectes célèbres du monde entier, vous guide parmi les principes de l'architecture et vous encourage dans votre propre construction créatrice.

LEGO® Architecture: entonces y ahora

Siempre ha existido una conexión natural entre el brick LEGO® y el mundo de la arquitectura. Los fans que construyen con elementos LEGO desarrollan instintivamente un interés por la forma y las funciones de las estructuras que crean. Al mismo tiempo, muchos arquitectos han descubierto que los bricks LEGO son una forma perfecta de expresar físicamente sus ideas creativas.

Esta relación se confirmó a principios de la década de 1960, con el lanzamiento de la línea «Scale Model» de LEGO. Encajaba bien con el espíritu de la época: un tiempo en el que los arquitectos modernos redefinían el aspecto de las casas y la gente se interesaba cada vez más por el diseño de su nuevo hogar. Los sets se diseñaron para que se diferenciaban de los normales, que se comercializaban en cajas de brillantes colores, e incluían un libro sobre la arquitectura que proporcionaba inspiración a sus usuarios.

Décadas más tarde, el arquitecto y fan de LEGO Adam Reed Tucker reavivó la idea de expresar la arquitectura usando bricks LEGO y, en colaboración con The LEGO Group, lanzó la línea LEGO Architecture que hoy conocemos. Sus primeros modelos, y los sets originales de la actual serie LEGO Architecture, eran interpretaciones de los rascacielos más famosos de su ciudad natal, Chicago. Desde entonces, LEGO Architecture se ha desarrollado y ha evolucionado, primero incorporando edificios célebres de otras ciudades de Estados Unidos y, ahora, estructuras emblemáticas de Europa, Oriente Próximo y Asia.

La introducción del set LEGO Architecture Studio recupera las ambiciones de la antigua línea «Scale Model» de LEGO y amplía el potencial de la serie LEGO Architecture. Hoy puedes disfrutar mientras construyes y aprendes sobre edificios célebres, o crear tus propios modelos arquitectónicos a partir de tu imaginación. Un instructivo libro de 270 páginas con materiales creados por arquitectos internacionales de gran reputación te guiará a través de los principios de la arquitectura y te animará a dar tus primeros pasos en el mundo de la construcción creativa.

Celebrate the world of architecture
Célébrez le monde de l'architecture
Celebra el mundo de la arquitectura

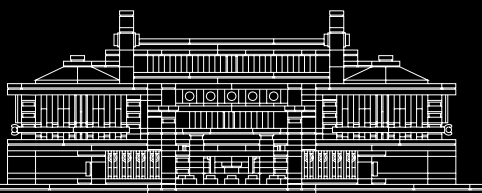

21017
Imperial Hotel
Hôtel Imperial

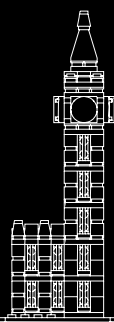

21013
Big Ben

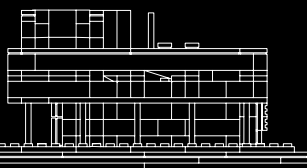

21014
Villa Savoye

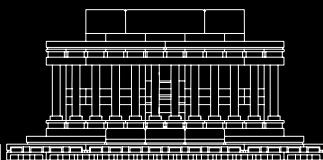

21022
Lincoln Memorial
Le monument de Lincoln
Monumento a Lincoln

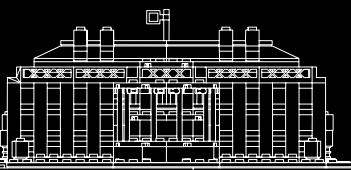

21006
The White House
La Maison-Blanche

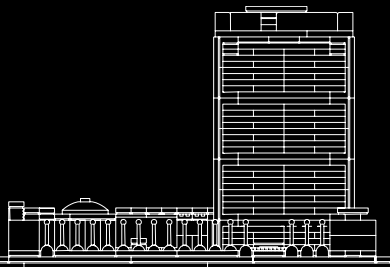

21018
United Nations Headquarters
Le siège des Nations Unies

and collect all the models
et collectionnez tous les modèles
y colecciona todos los modelos

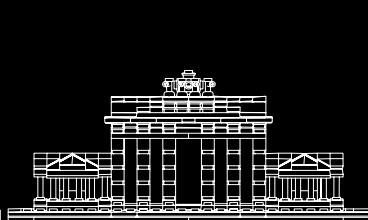

21011
Brandenburg Gate
La porte de Brandebourg



21020
Trevi Fountain
La fontaine de Trevi
Fontana de Trevi

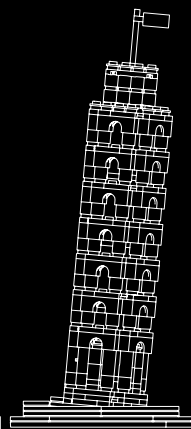

21015
The Leaning Tower of Pisa
La tour penchée de Pise

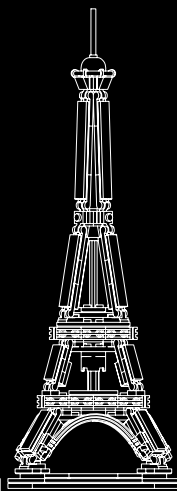

21019
The Eiffel Tower
La tour Eiffel
La torre Eiffel

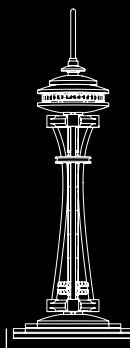

21003
Seattle
Space Needle

References

Text credits:

The Flatiron Building: The New York Landmark and the Incomparable City That Arose with It, Alice Sparberg Alexiou, Thomas Dunne Books, 2010.

Photo credits:

Shutterstock.com
Wikipedia.org
Veronica Mainetti, Sorgente Group of America
Per Tropp-Christiansen
Gettyimages.com

Références

Crédits textes :

The Flatiron Building: The New York Landmark and the Incomparable City That Arose with It, Alice Sparberg Alexiou, Thomas Dunne Books, 2010.

Crédits photos :

Shutterstock.com
Wikipedia.org
Veronica Mainetti, Sorgente Group of America
Per Tropp-Christiansen
Gettyimages.com

Referencias

Redacción:

The Flatiron Building: The New York Landmark and the Incomparable City That Arose with It, Alice Sparberg Alexiou, Thomas Dunne Books, 2010.

Fotografías:

Shutterstock.com
Wikipedia.org
Veronica Mainetti, Sorgente Group of America
Per Tropp-Christiansen
Gettyimages.com

Customer Service
Kundenservice
Service Consommateurs
Servicio Al Consumidor

LEGO.com/service or dial



00800 5346 5555 :

1-800-422-5346 :





5x
4113915



18x
4109995



8x
4124455



6x
4162465



4x
4112982



4x
6024495



9x
4516055



12x
6046922



20x
6046924



3x
4159553



21x
4125253



45x
4124456



21x
4113917



20x
4114026



10x
4121921



4x
4113233



3x
4124067



2x
4161734



2x
663626



1x
6101020



3x
416226



4x
383226



18x
6038458



27x
4529685



9x
6001197



16x
6101254



12x
6055172



26x
4549436



10x
4528604



27x
4496699



18x
4626904



4x
4211055



2x
4568734



8x
4560184



1x
6011459



1x
4211461



5x
4211389



1x
4211388



7x
4558953



2x
4211476



2x
4211399



1x
4211415



2x
4565393



4x
4211429



9x
4211445



3x
4211425



10x
4211407



2x
4211408



12x
6014615



2x
6102769



4x
4515374



1x
4654448

