

LASER PEGS®

The Ultimate Construction Toy For Kids®

MODELS
MODELES
12 IN 1
MODELL • MODEL

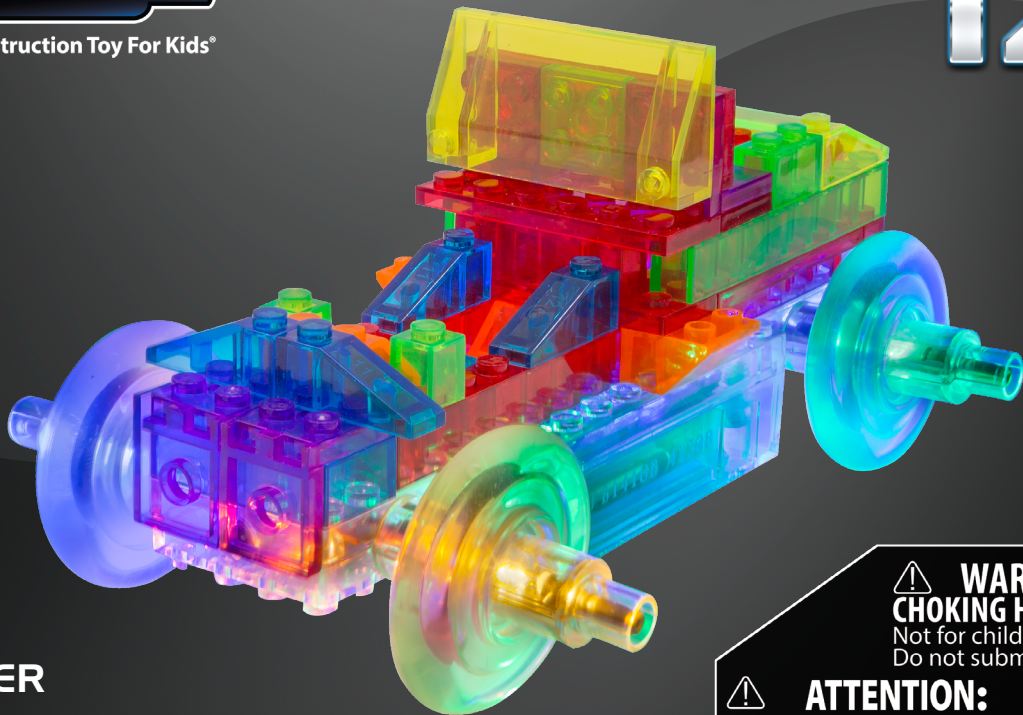

60's RACER
PB 2160B

www.LaserPegs.com



WARNING:
CHOKING HAZARD - Small parts.
Not for children under 3 yrs.
Do not submerge in water.



ATTENTION:
DANGER DE SUFFOCATION - Petits éléments.
Ne convient pas aux enfants de moins de trois ans.
Ne pas immerger le jeu dans l'eau.

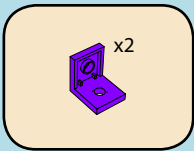
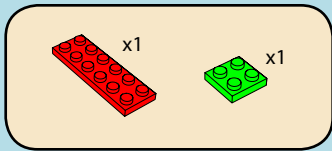

1

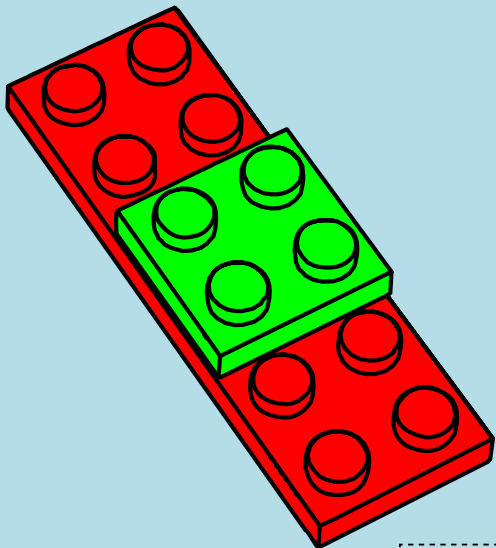

2

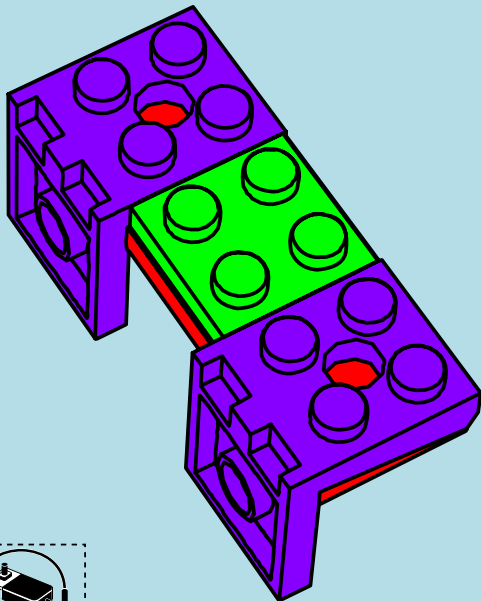

The TRY-ME mechanism is for display purposes ONLY and should be discarded as per state and local regulations. It is NOT intended to be used for the building of this model.

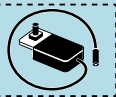

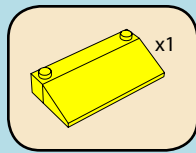

3

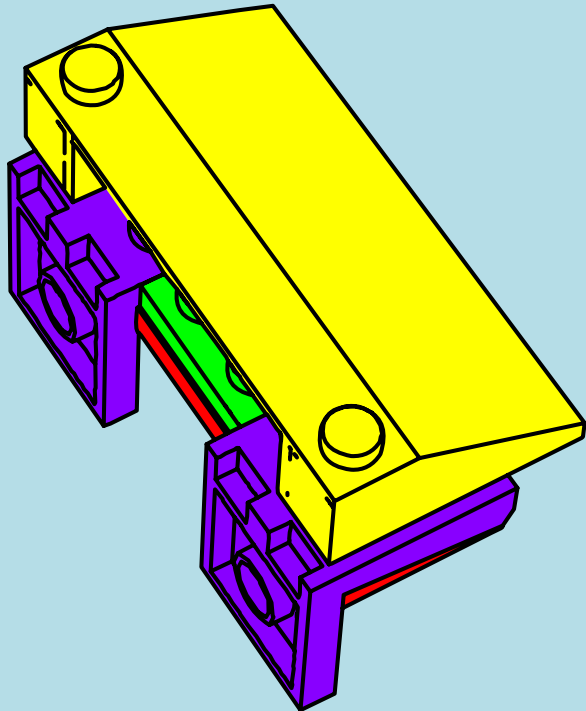

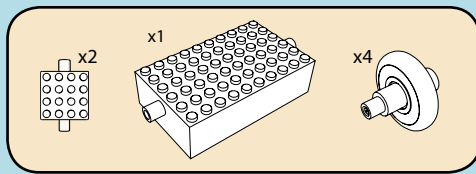

1

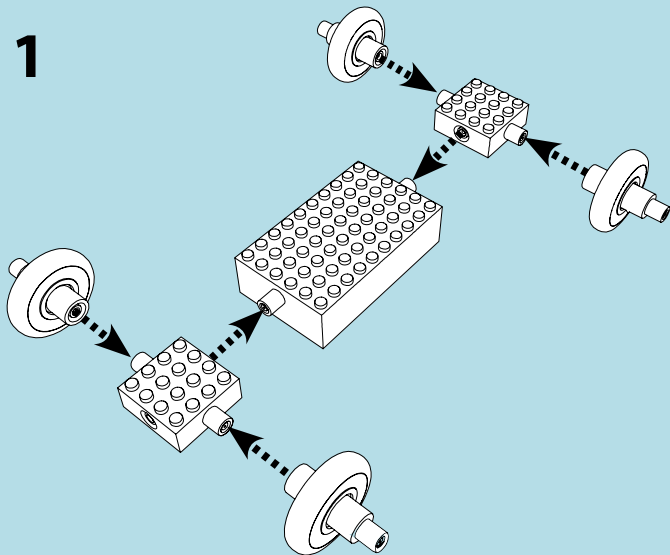

1 a

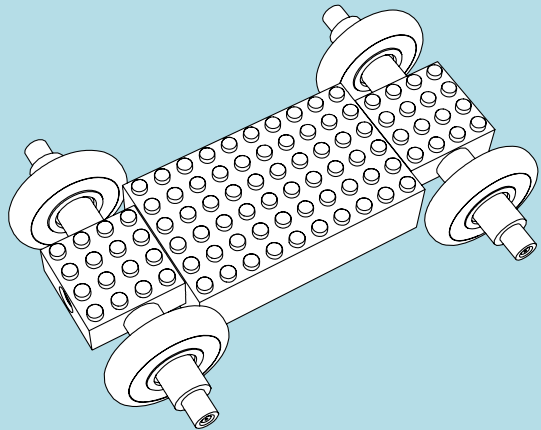

2

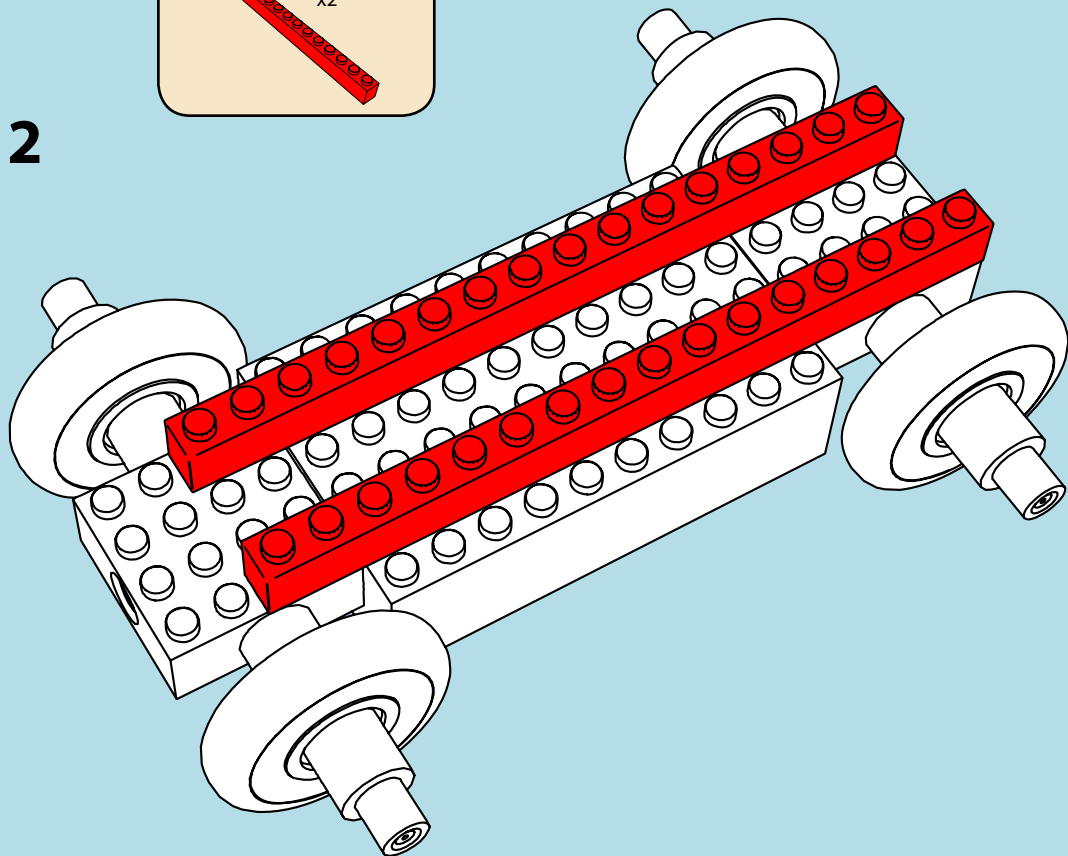
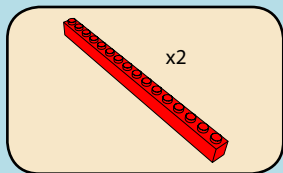

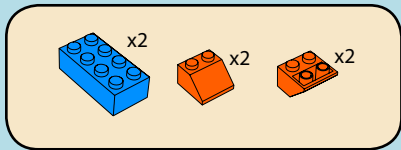

3

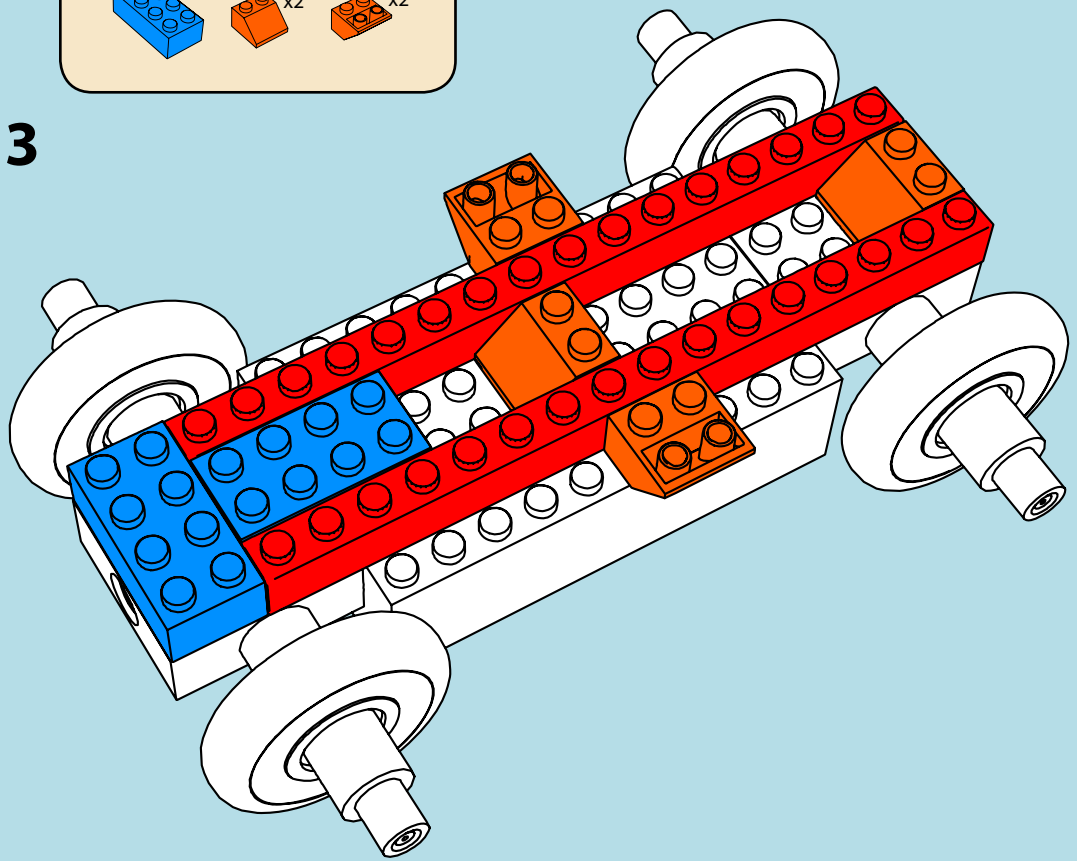

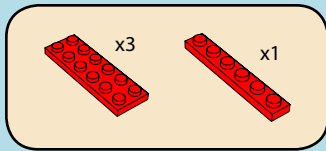

4

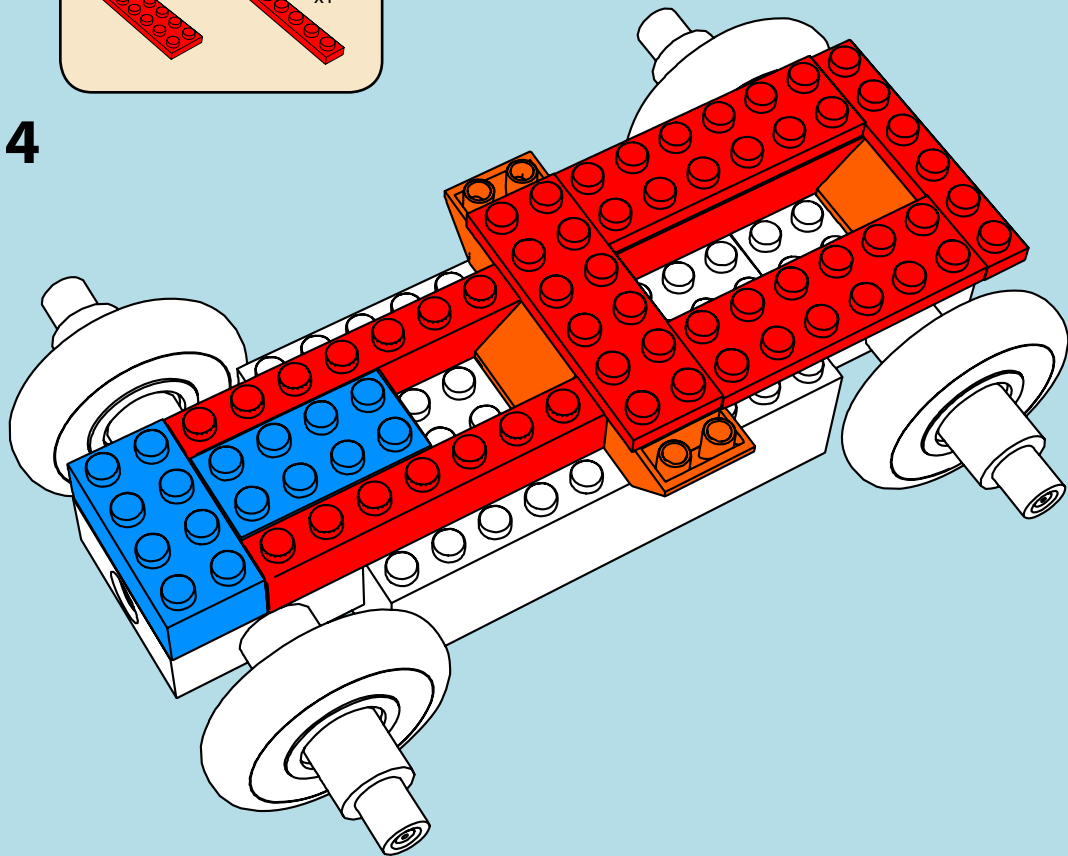

5

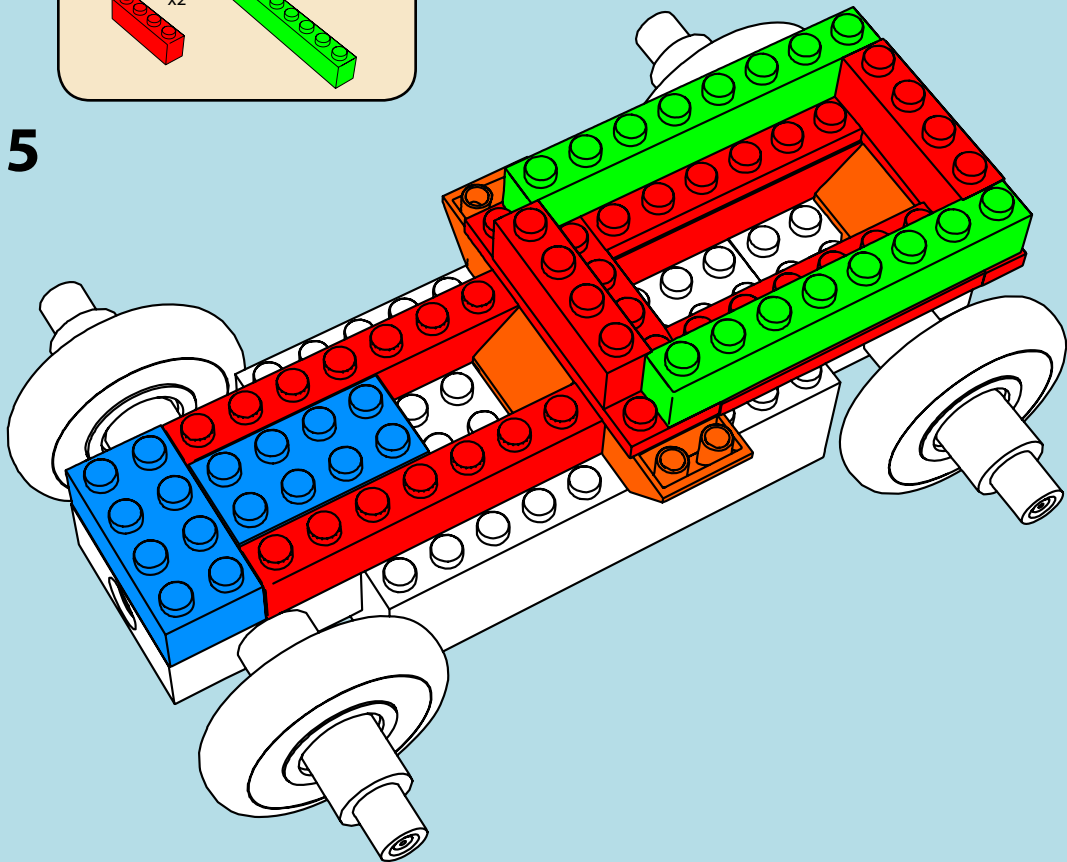
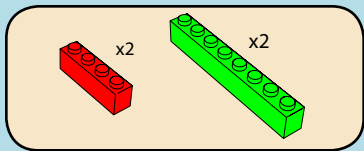

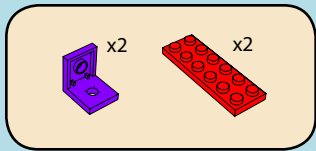

6

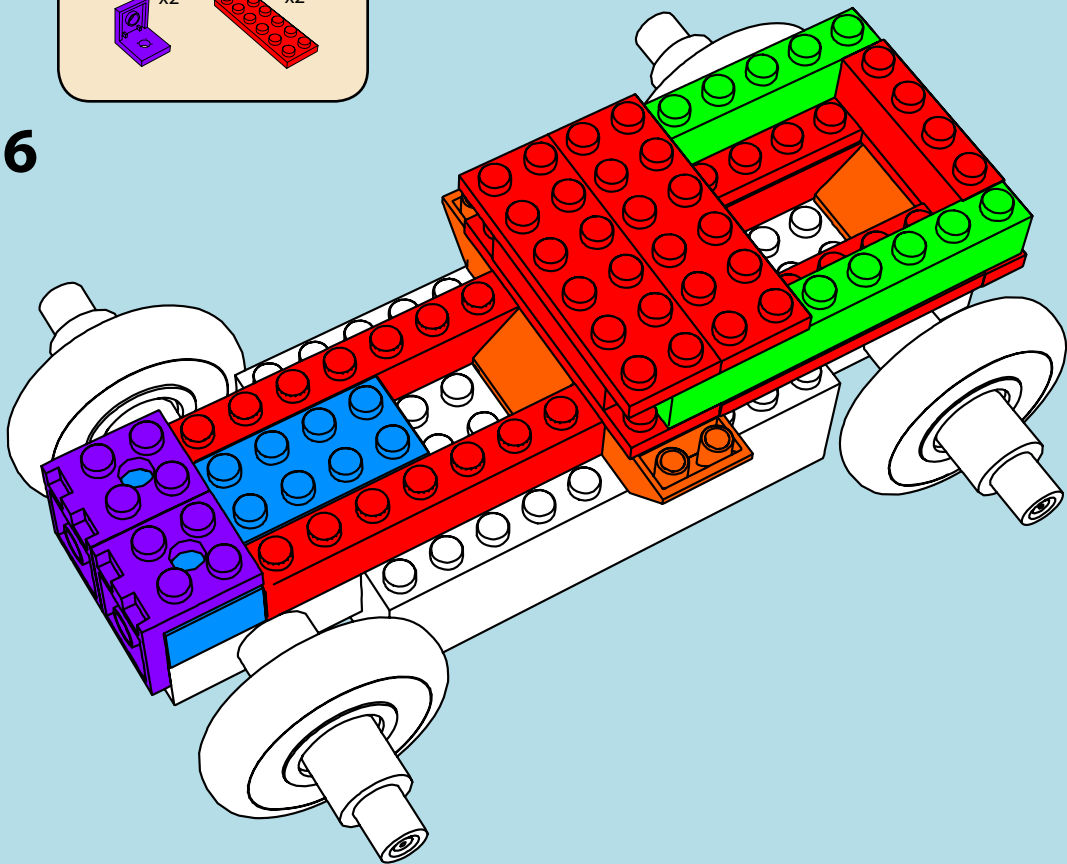

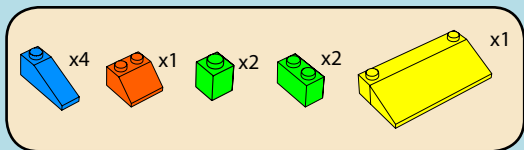

7

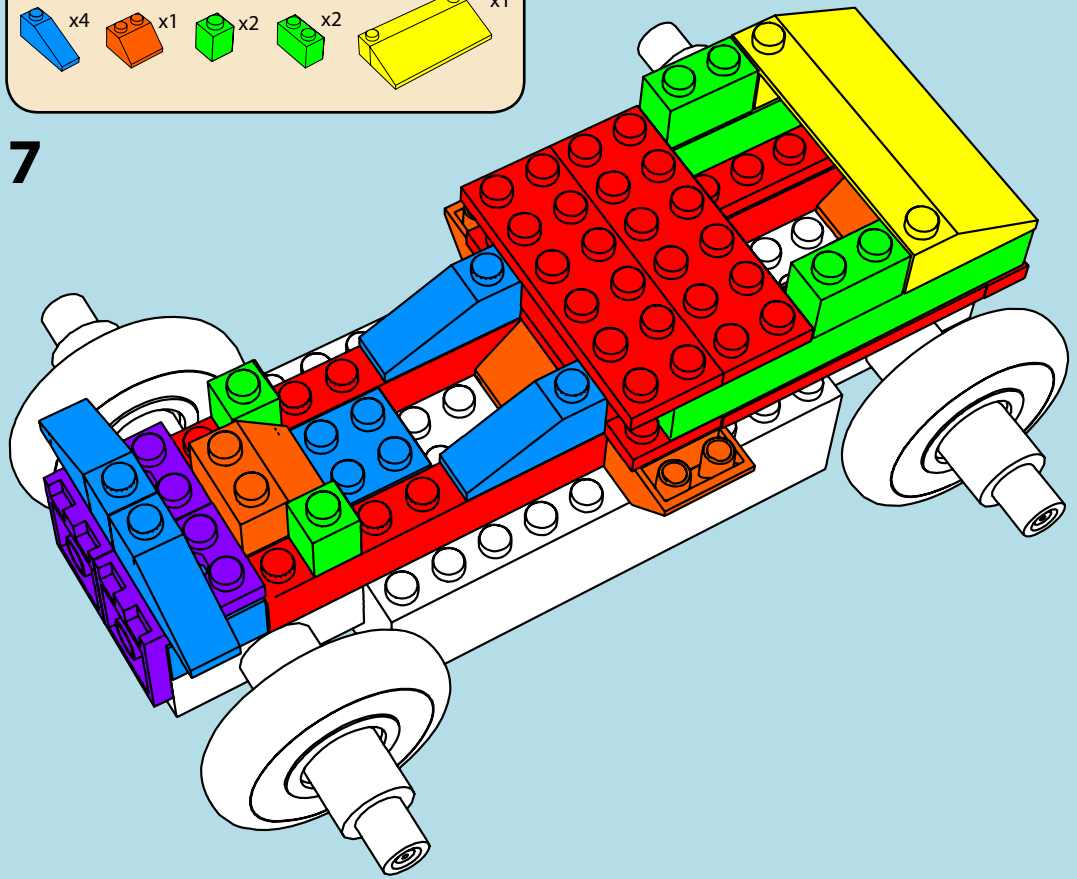

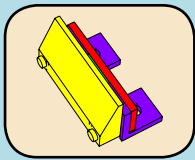

8

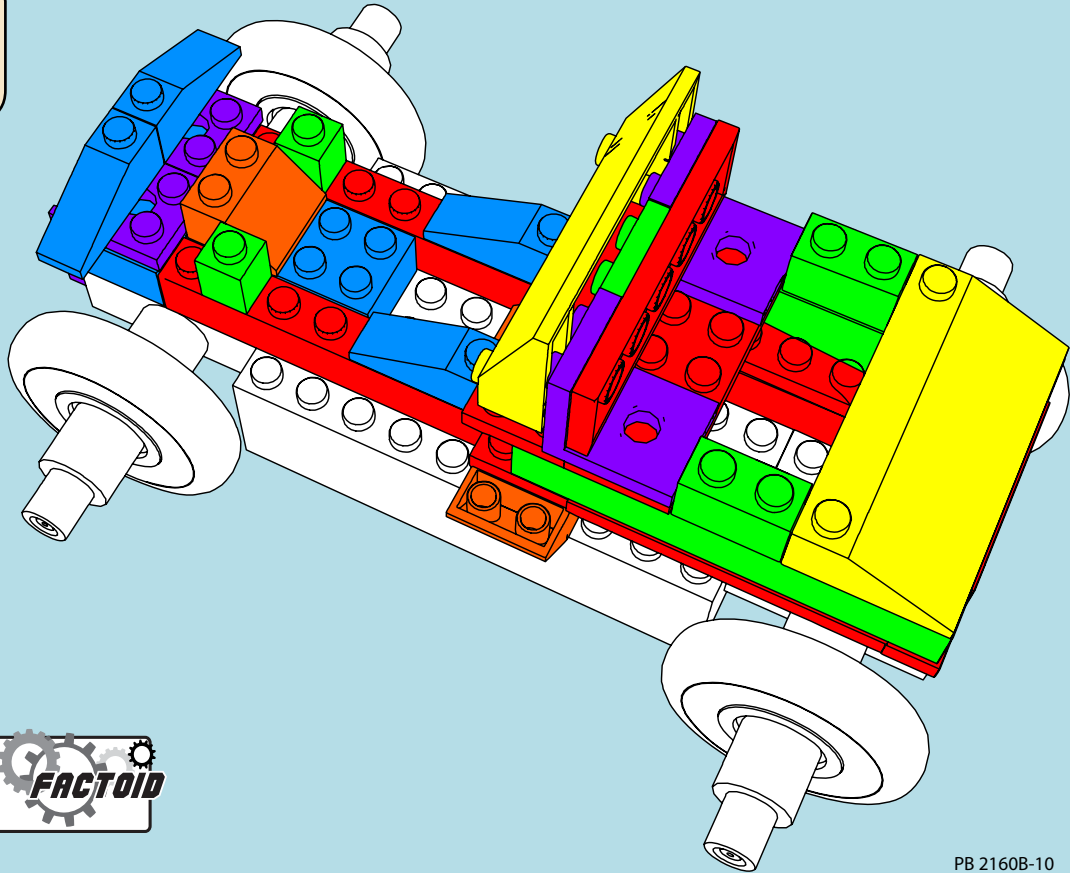

60's RACER: The first hot rods were old cars (most often Fords, typically Model Ts, 1928-31 Model As, or 1932-34 Model Bs), modified to reduce weight.



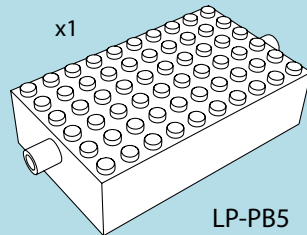
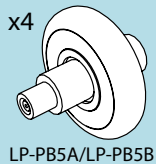
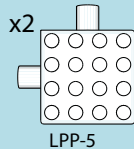
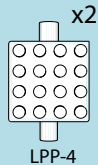

x2

TLPCS-101



x10

TLPCR-104



x8

TLPCR-105



x8

TLPCR-107



x2

TLPCR-108



x2

TLPCS-109

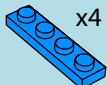

x4

TLPCS-111

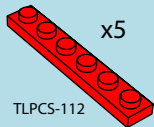

x5

TLPCS-112

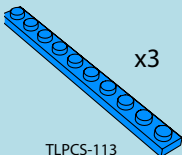

x3

TLPCS-113



x3

TLPCS-116



x8

TLPCS-118

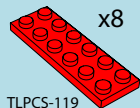

x8

TLPCS-119

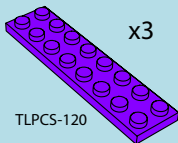

x3

TLPCS-120

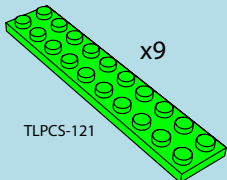

x9

TLPCS-121



x2

TLPCT-122



x5

TLPCT-123

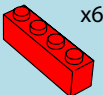

x6

TLPCT-125

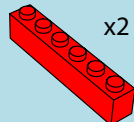

x2

TLPCT-126

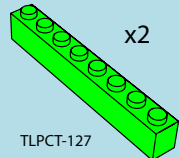

x2

TLPCT-127

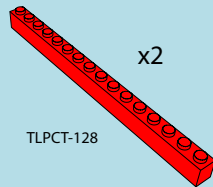

x2

TLPCT-128



x1

TLPCT-129

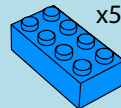

x5

TLPCT-131

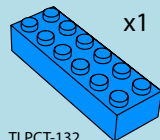

x1

TLPCT-132

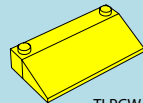

x4

TLPWC-133



x6

TLPC-134

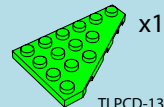

x1

TLPCD-135

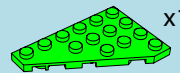

x1

TLPCD-136

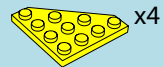

x4

TLPCD-137