

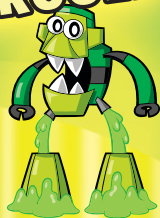

Mixels™

GURGGLE



41549



 LEGO.com

6126515

1

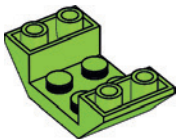

2

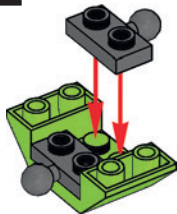

3

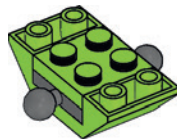

4

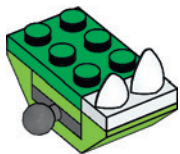

5

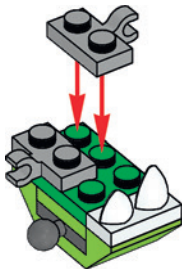

6

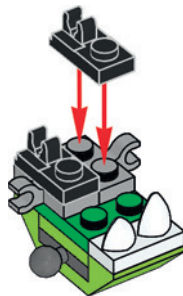

1



2

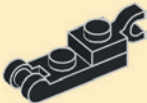

3



2x

7

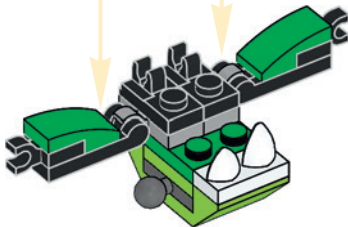



8



9



10



11

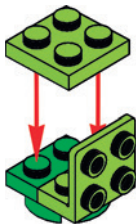

12



13

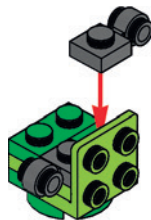

14

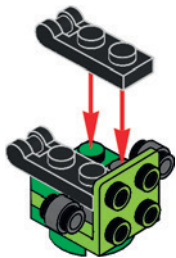

15

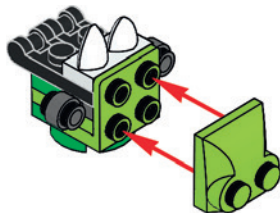

16



17



18

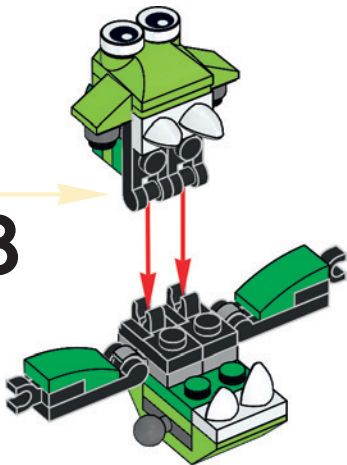

19

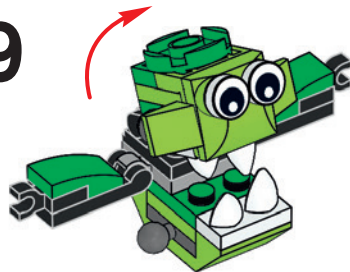



20

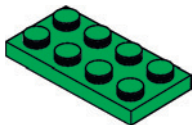

21

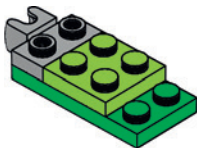

22

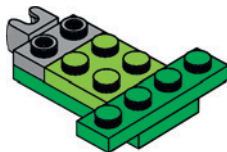

23

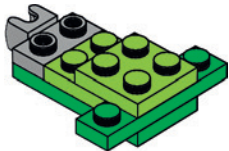

24

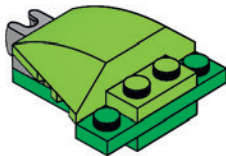

25

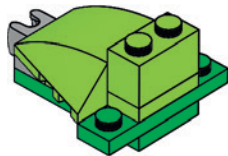

26

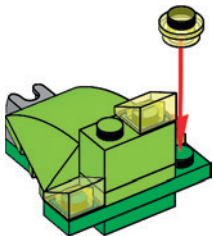

27

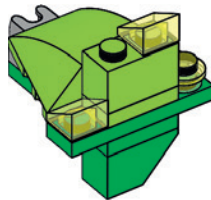



28



29

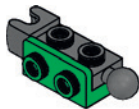

30

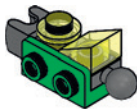

31



32

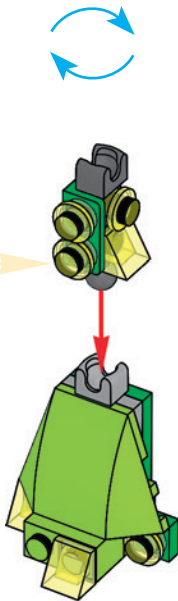

33

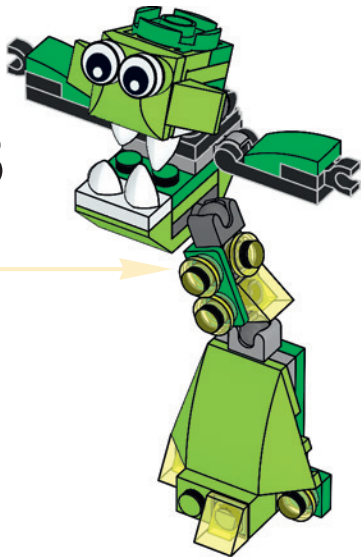



34

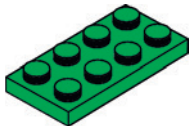

35

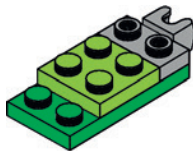

36

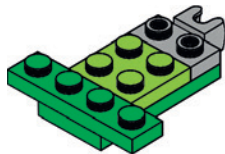

37

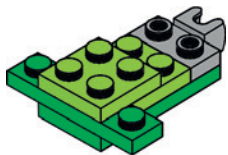

38

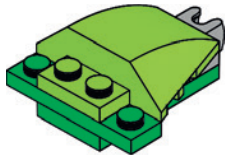

39

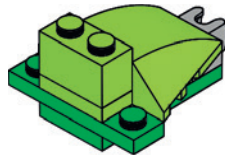

40

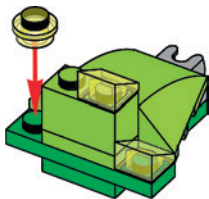

41

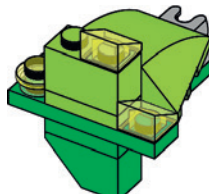



42



43

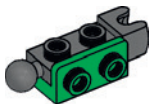

44

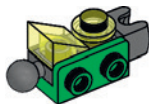

45



46

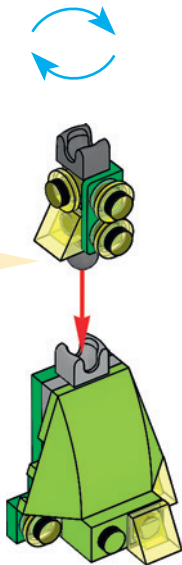

47

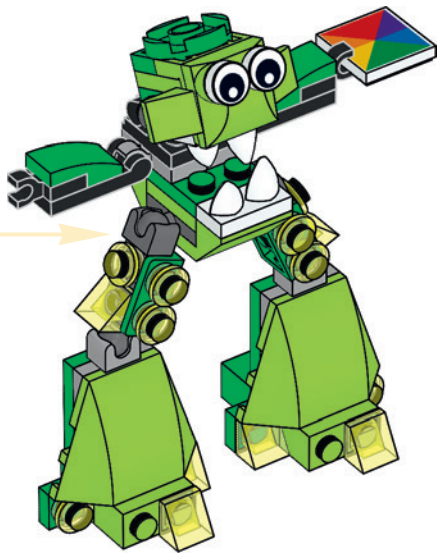



1x
6109149



2x
6046384



2x
6043656



2x
4504372



2x
302328



6x
6076751



2x
4517925



2x
6028812



6x
4537937



1x
302128



8x
3005749



2x
4598528



2x
4632574



1x
6094031



2x
371028



2x
6029156



4x
4515368



2x
6039479



2x
4164022



2x
302028



Customer Service

Kundenservice

Service Consommateurs

Servicio Al Consumidor

LEGO.com/service or dial



00800 5346 5555 :



1-800-422-5346 :



2x
6039482



1x
6025028



2x
6099243



1x
403228



1x
6110067



2x
4142989



2x
6023954



2x
6047426



**DRIBBAL
41548**



**GURGGLE
41549**



**SLUSHO
41550**



**GLORP CORP
MAX!**



LEGO.com/mixels





Mixels™

SERIES
6



41545
KRAMM



41546
FORX



41547
WUZZO



41548
DRIBBAL



41549
GURGGLE



41550
SLUSHO



41551
SNAX



41552
BERP



41553
VAKA-WAKA



LEGO.com/mixels



Mixels RUSH



**YOU CAN
BUY THE
GAME!**

S6PERS1NUS

IN GAME CODE!



Apple, the Apple logo, iPad, iPhone and iPod touch are trademarks of Apple Inc., registered in the U.S. and other countries. App Store is a service mark of Apple Inc. Google Play is a trademark of Google Inc.

WIN

GO TO WWW.LEGO.COM/PRODUCTFEEDBACK AND
GIVE US YOUR SHORT **FEEDBACK** ABOUT THIS
LEGO® SET FOR A CHANCE TO WIN
A COOL LEGO PRIZE.



LEGO.com/productfeedback

GEWINNE



Erzähle uns auf
www.LEGO.com/productfeedback

etwas über die Erfahrungen, die
du mit diesem LEGO® Set gemacht
hast, und sichere dir die Chance auf
einen coolen LEGO Preis!

GAGNE



Rends-toi sur
www.LEGO.com/productfeedback

et donne-nous quelques commen-
taires sur ce produit LEGO® pour
avoir une chance de gagner un
prix LEGO !

GANA



Visita
www.LEGO.com/productfeedback

y envíanos tu opinión acerca de este
set LEGO®. ¡Participarás en el sorteo
de un premio LEGO!

获取奖品



登录
www.LEGO.com/productfeedback

给出关于此乐高®套装的简短反馈，
就有机会获得炫酷乐高奖品

LEGO, the LEGO logo and MIXELS are trademarks and/or copyrights of the LEGO Group.
©2015 The LEGO Group. All rights reserved.
TM & © 2015 Cartoon Network

6126515