



# NEXO KNIGHTS



70314



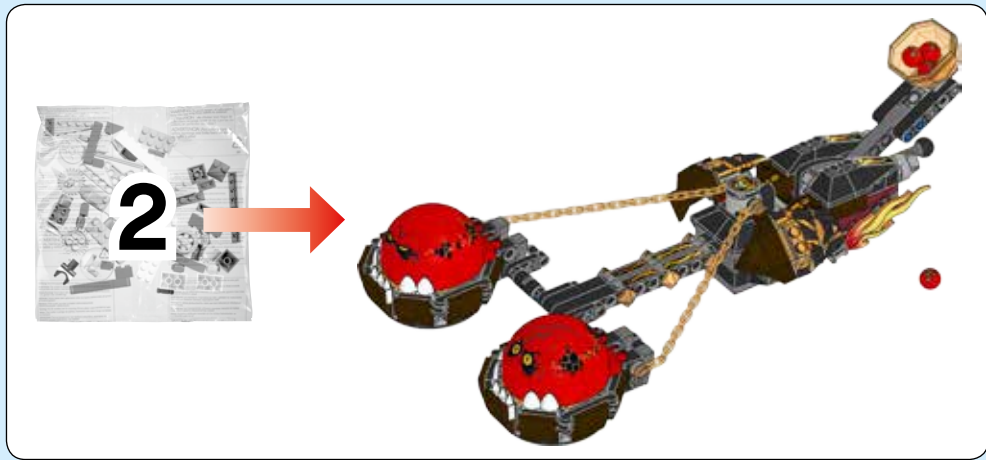

29

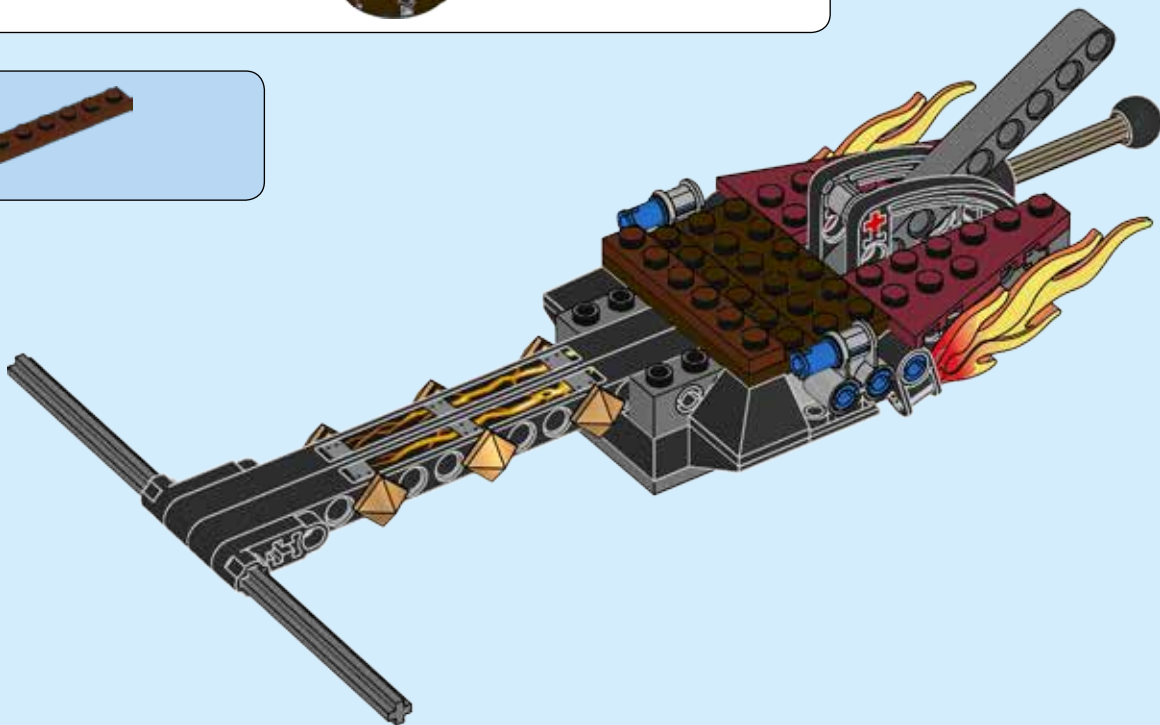

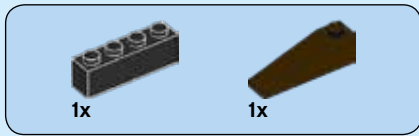

# 30

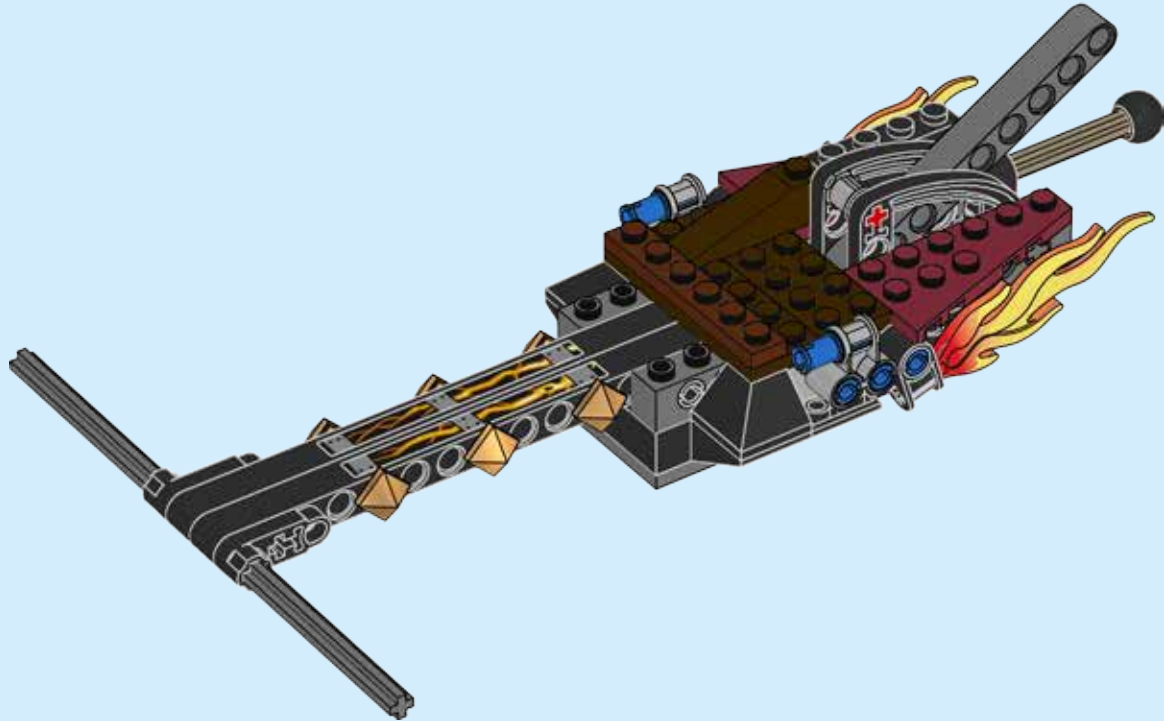



1x



1x

# 31

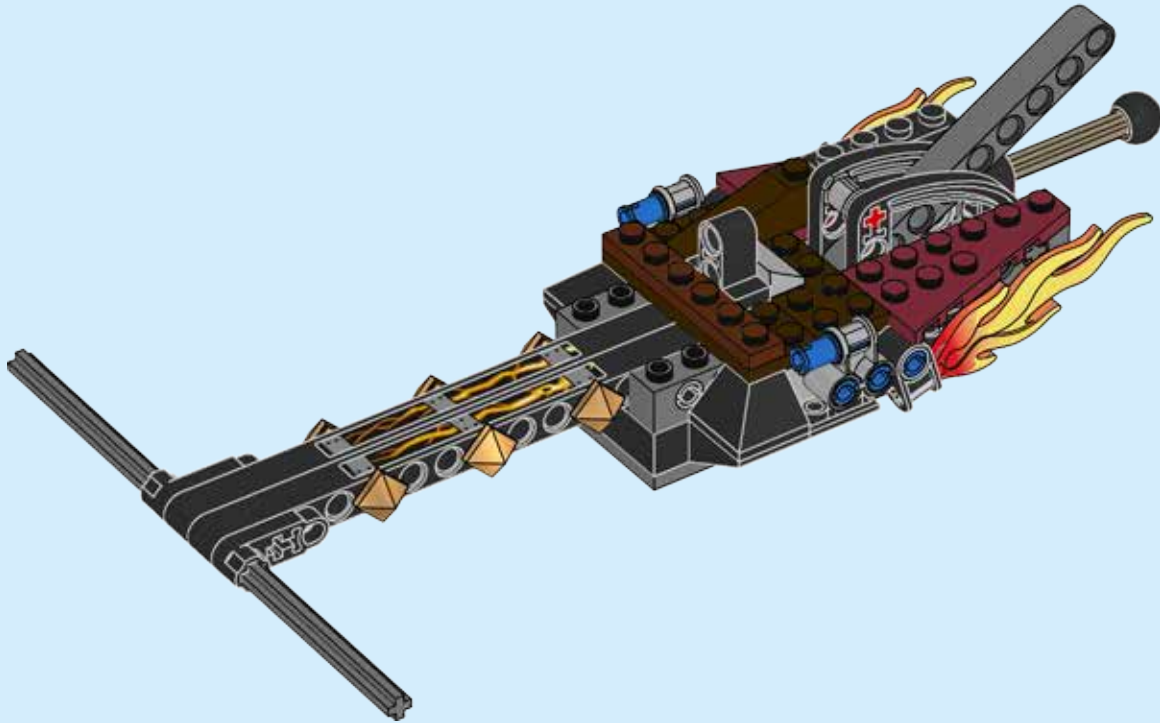



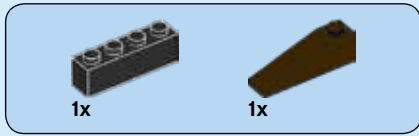

32

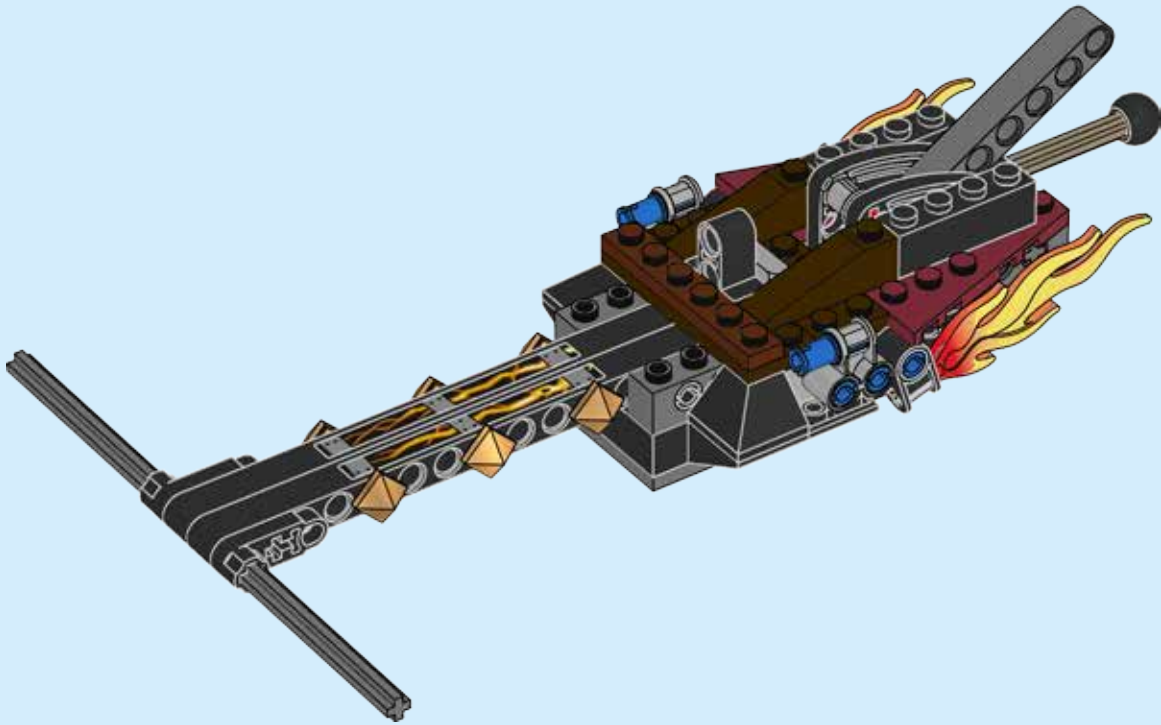





4x

# 34

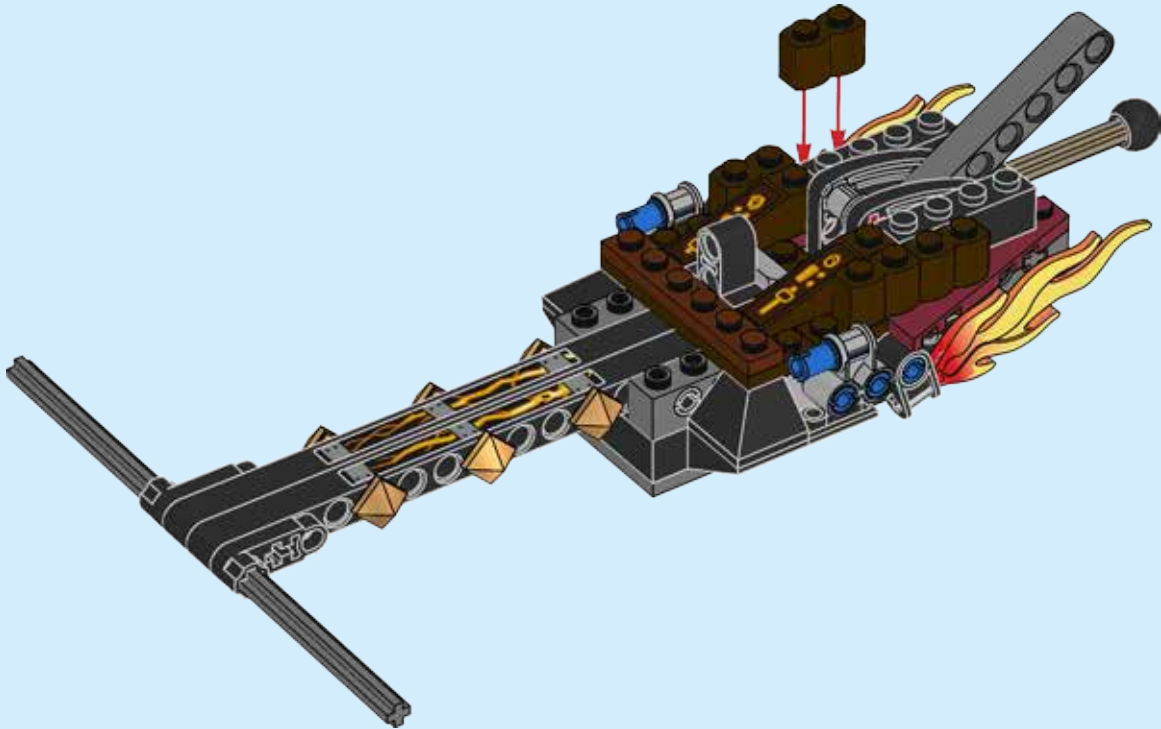



2x

# 35

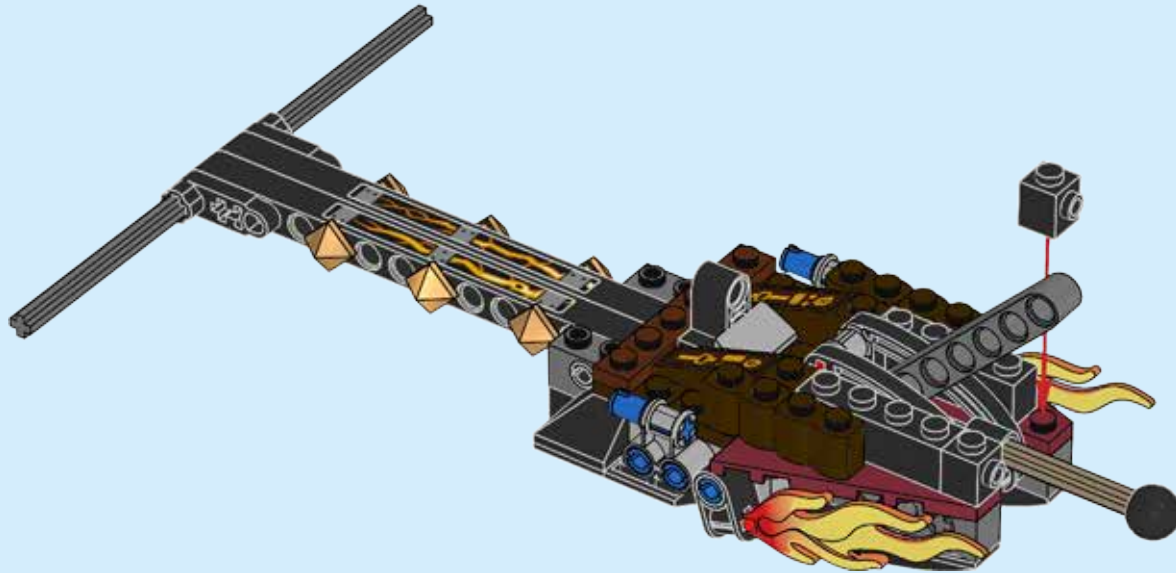
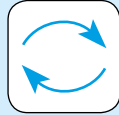



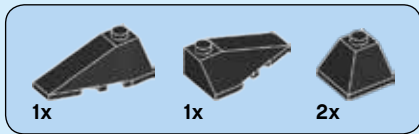

36





2x

# 37





# 38

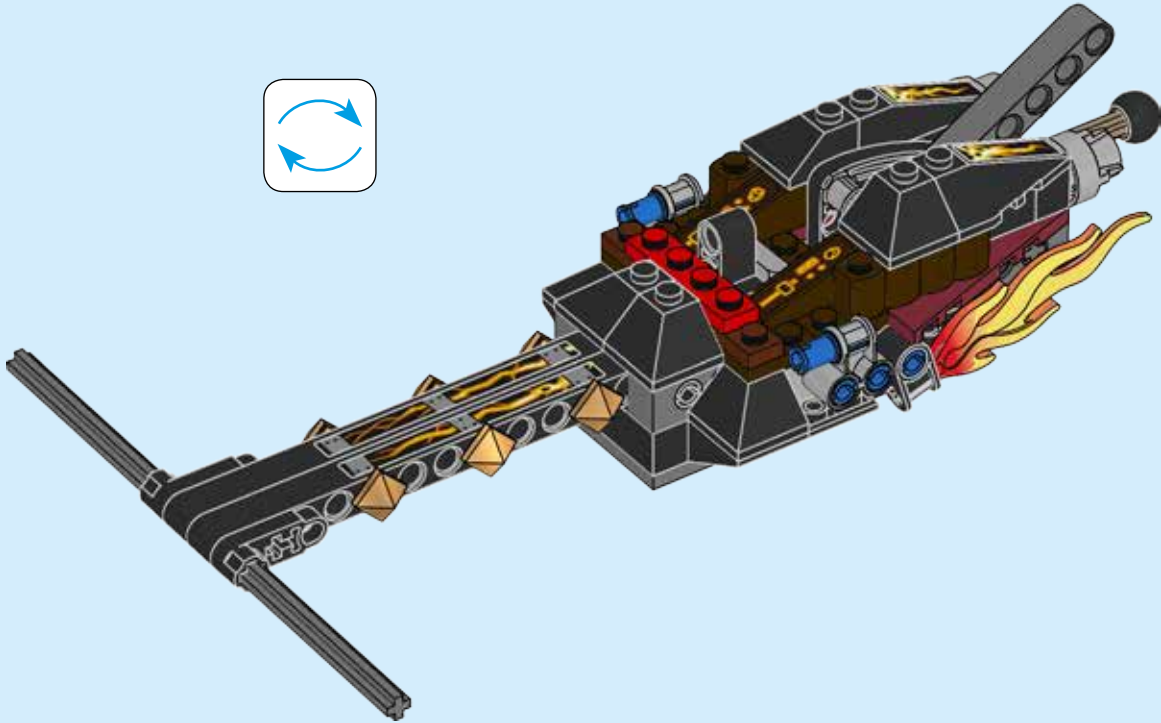
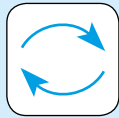



1x



2x

# 39

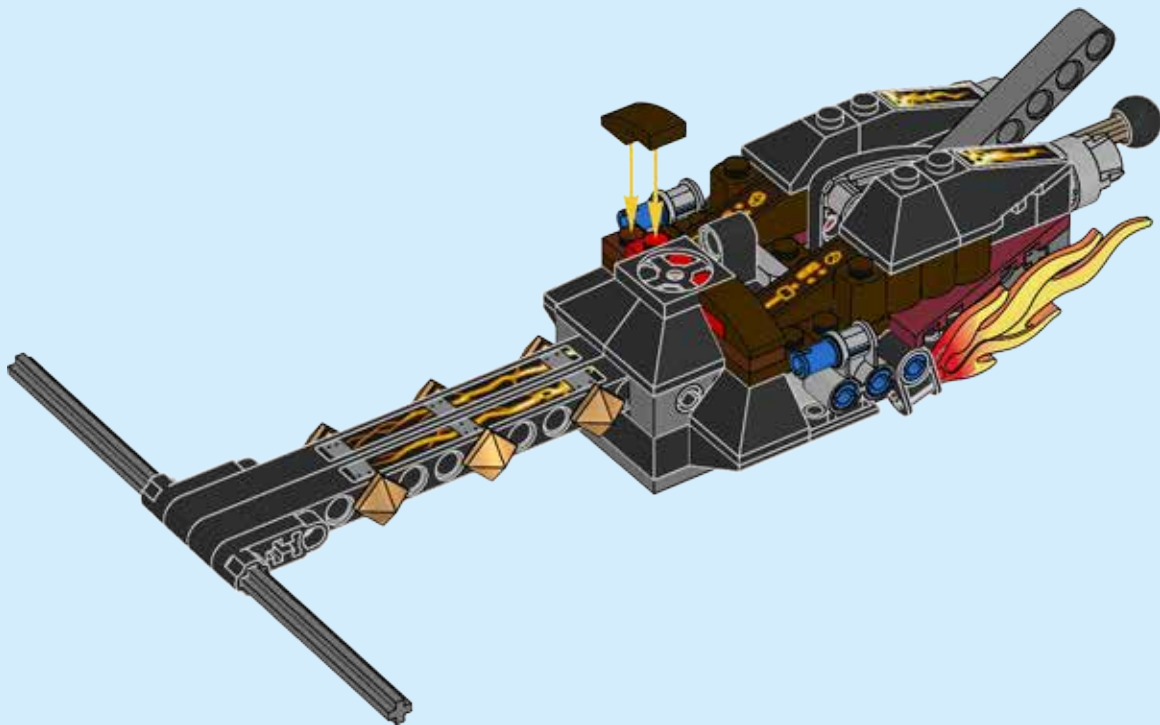





1x

# 40

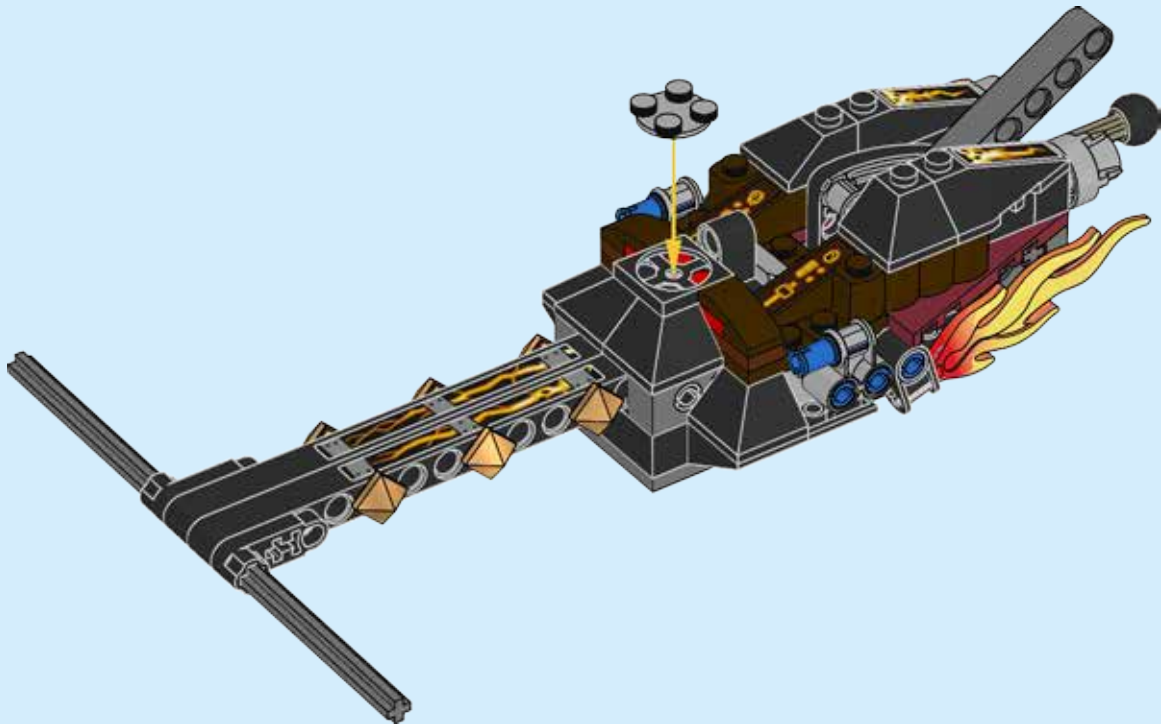



# 41

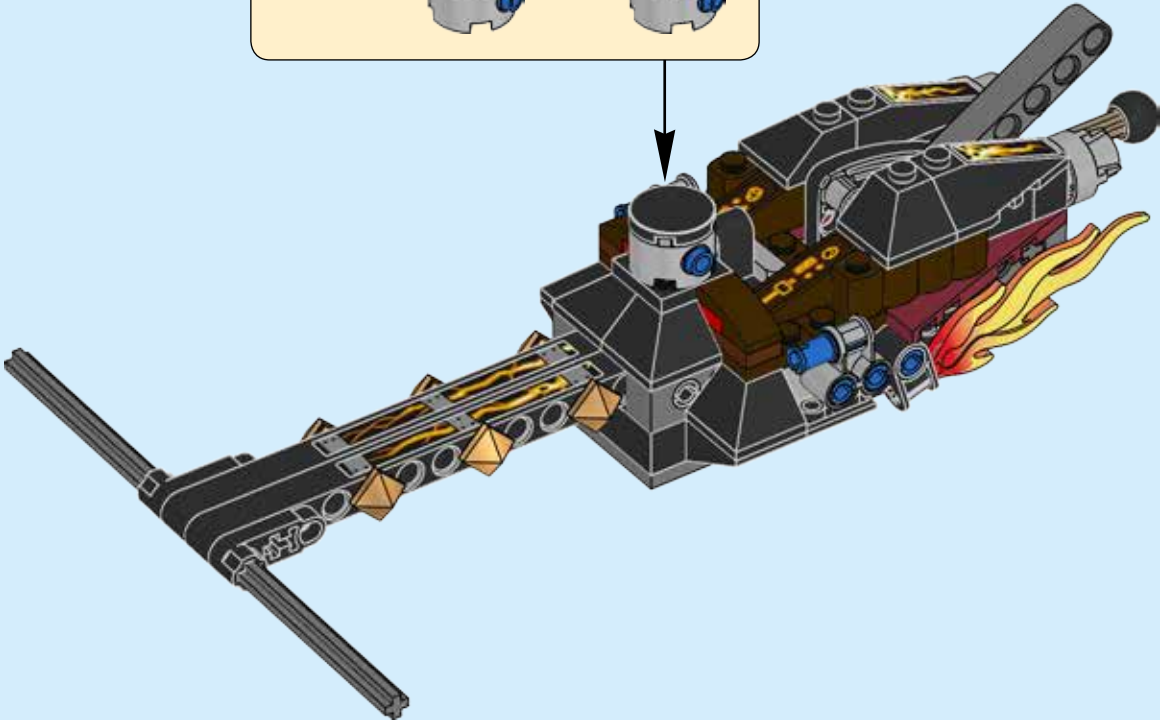
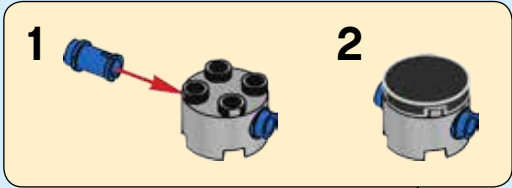



2x

# 42

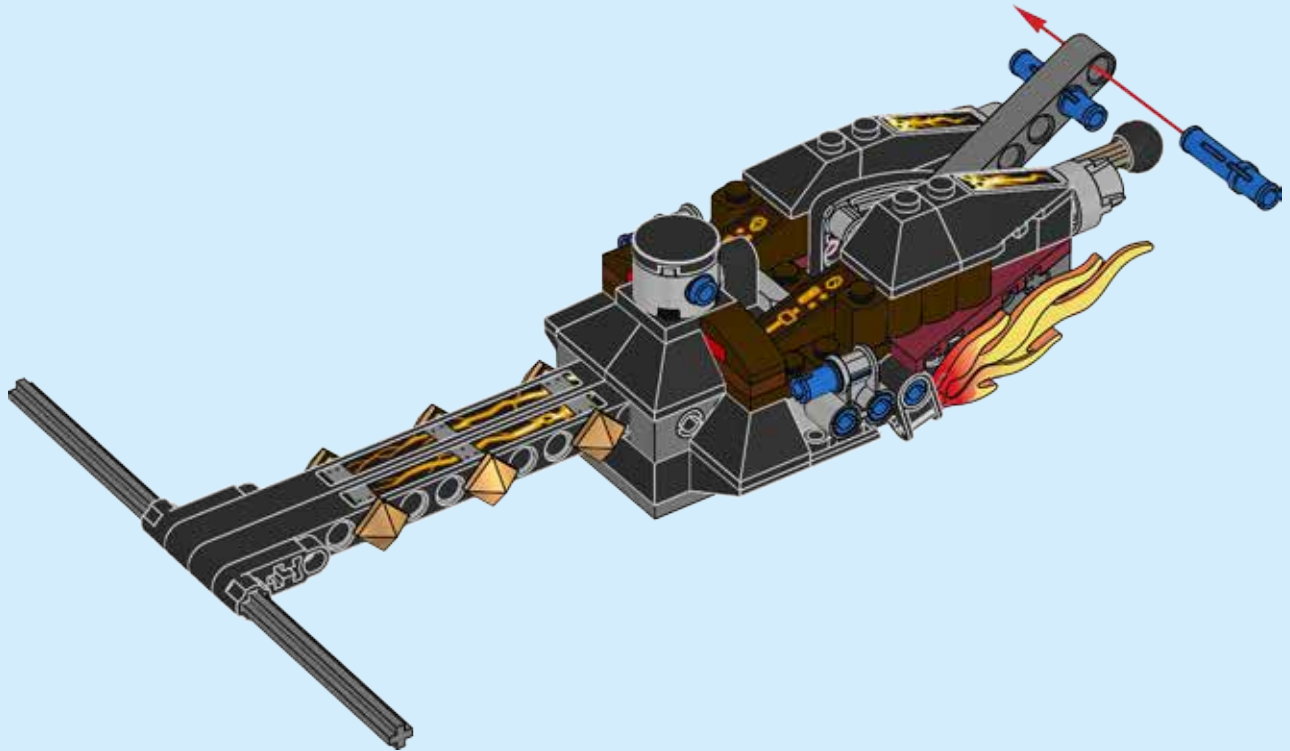



1x

# 43





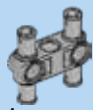

1x

# 44



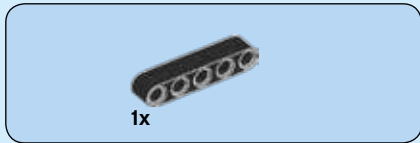

45

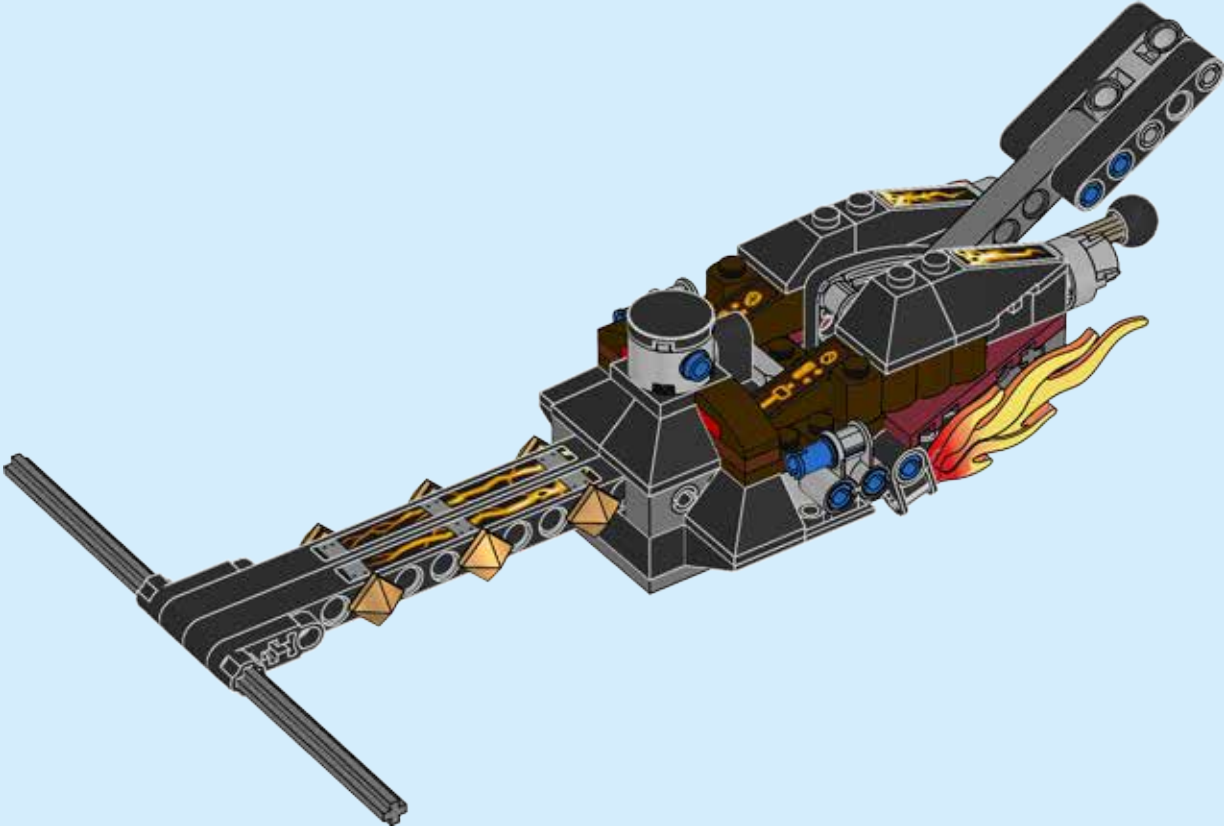

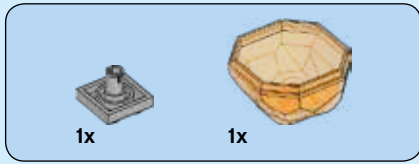

46

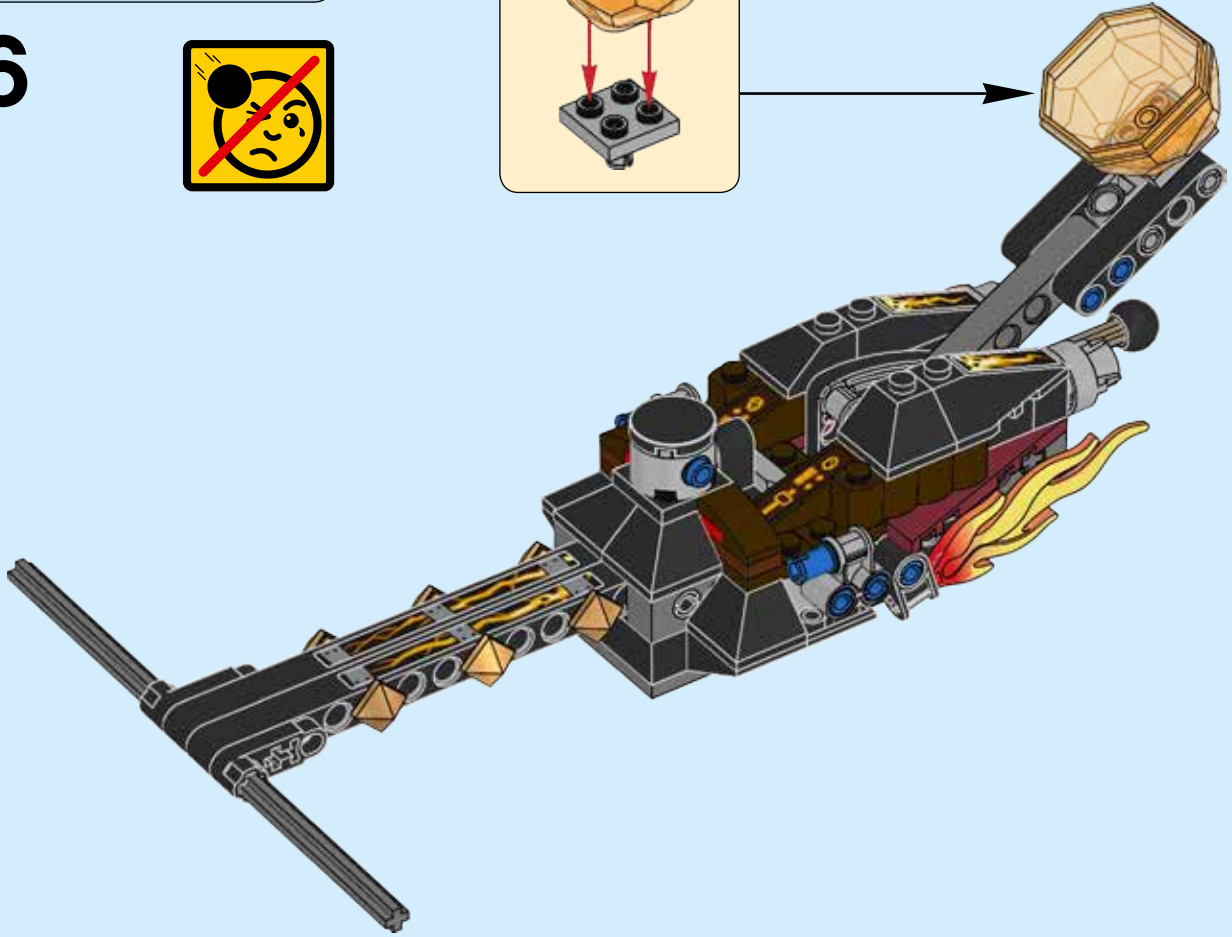
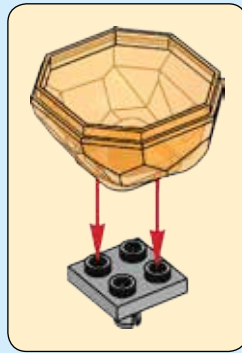



2x



1x



1x

47

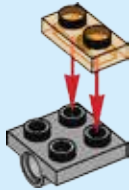

1x

48

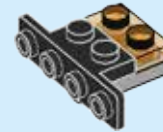





1x

# 49

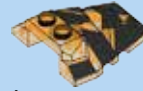
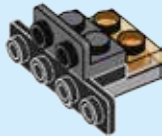

1x

# 50





1x

# 51



1x



1x

# 52

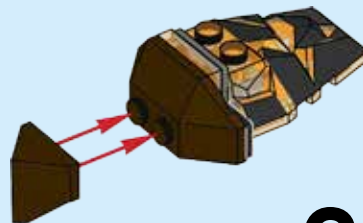

# 2x

53

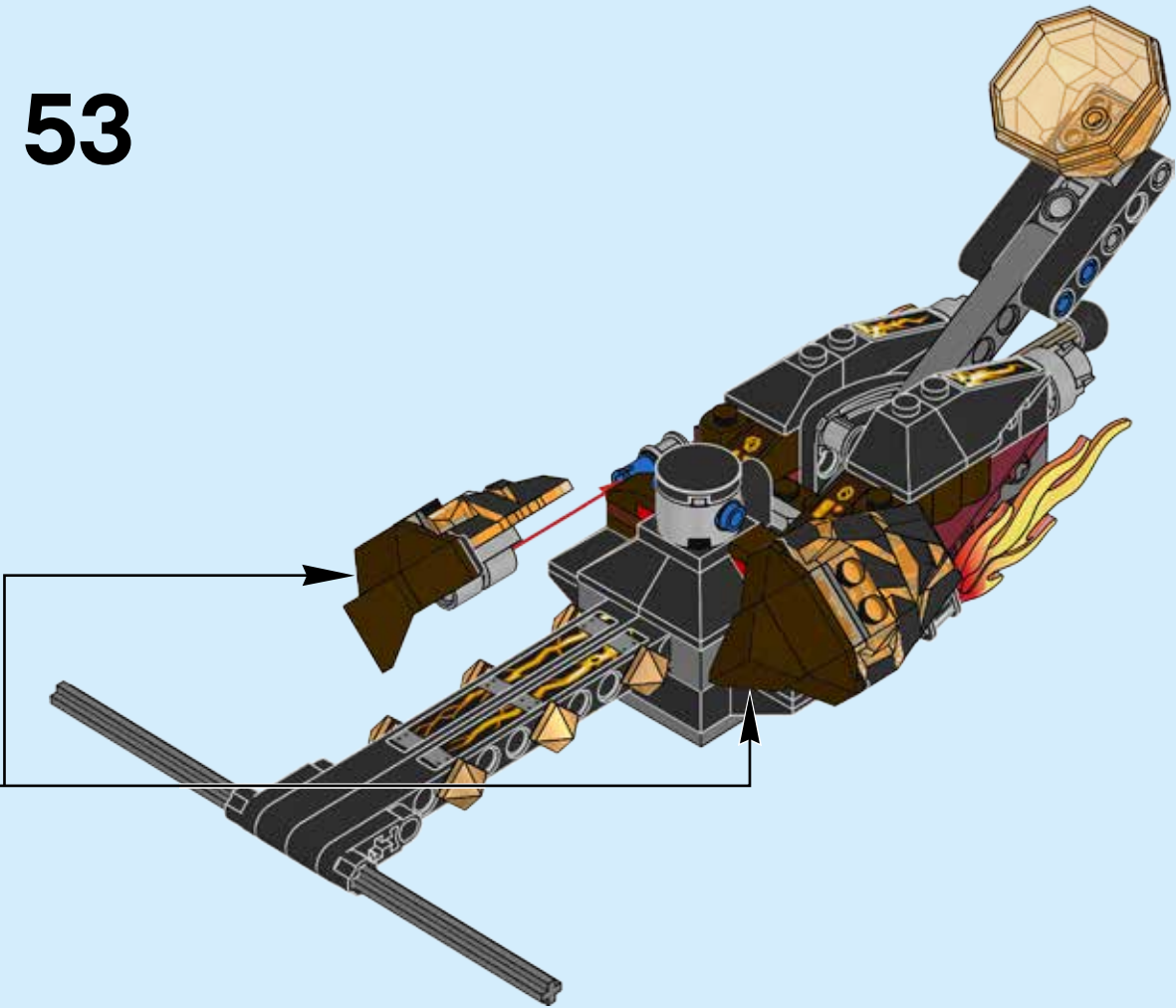



2x

# 54

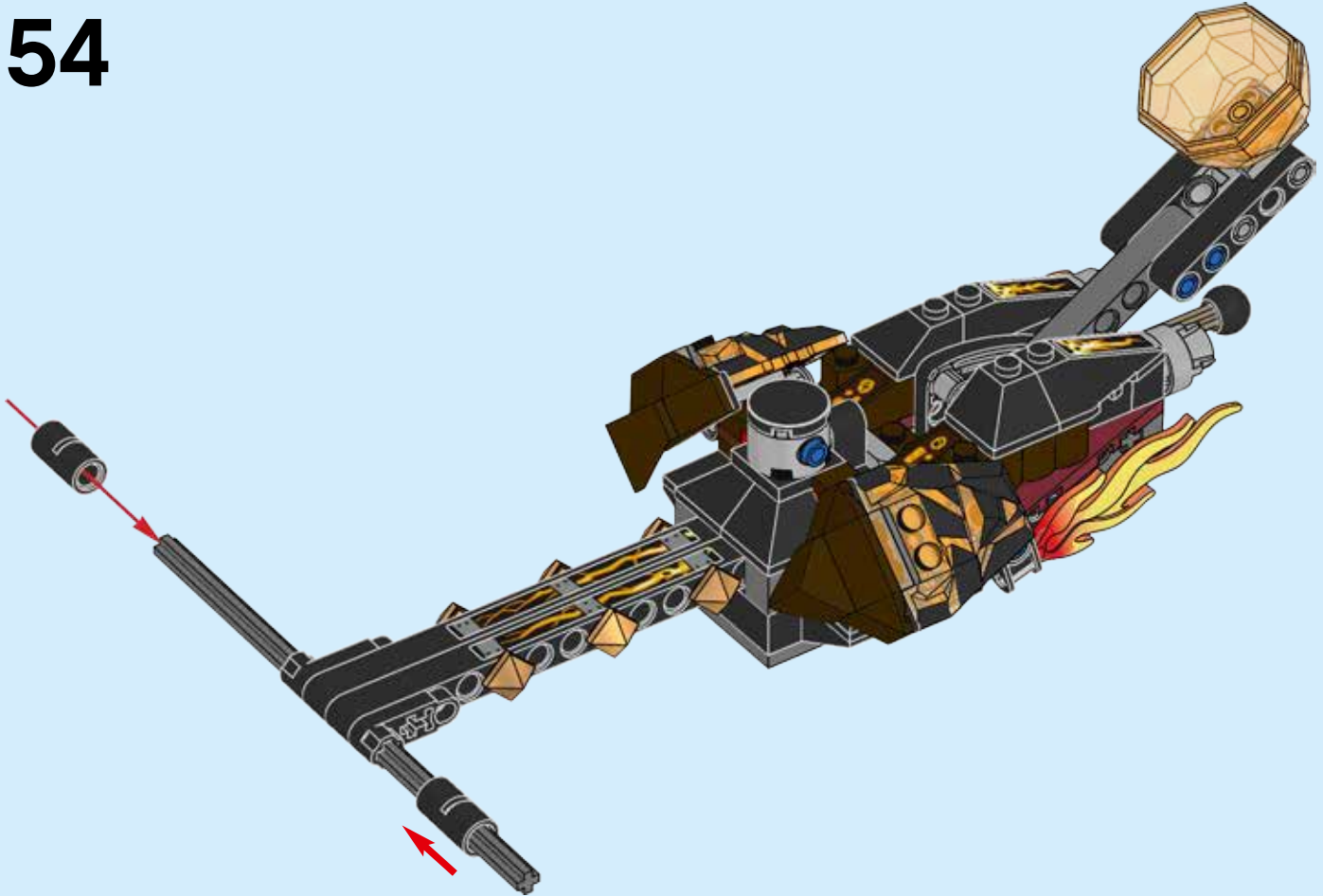



2x

# 55

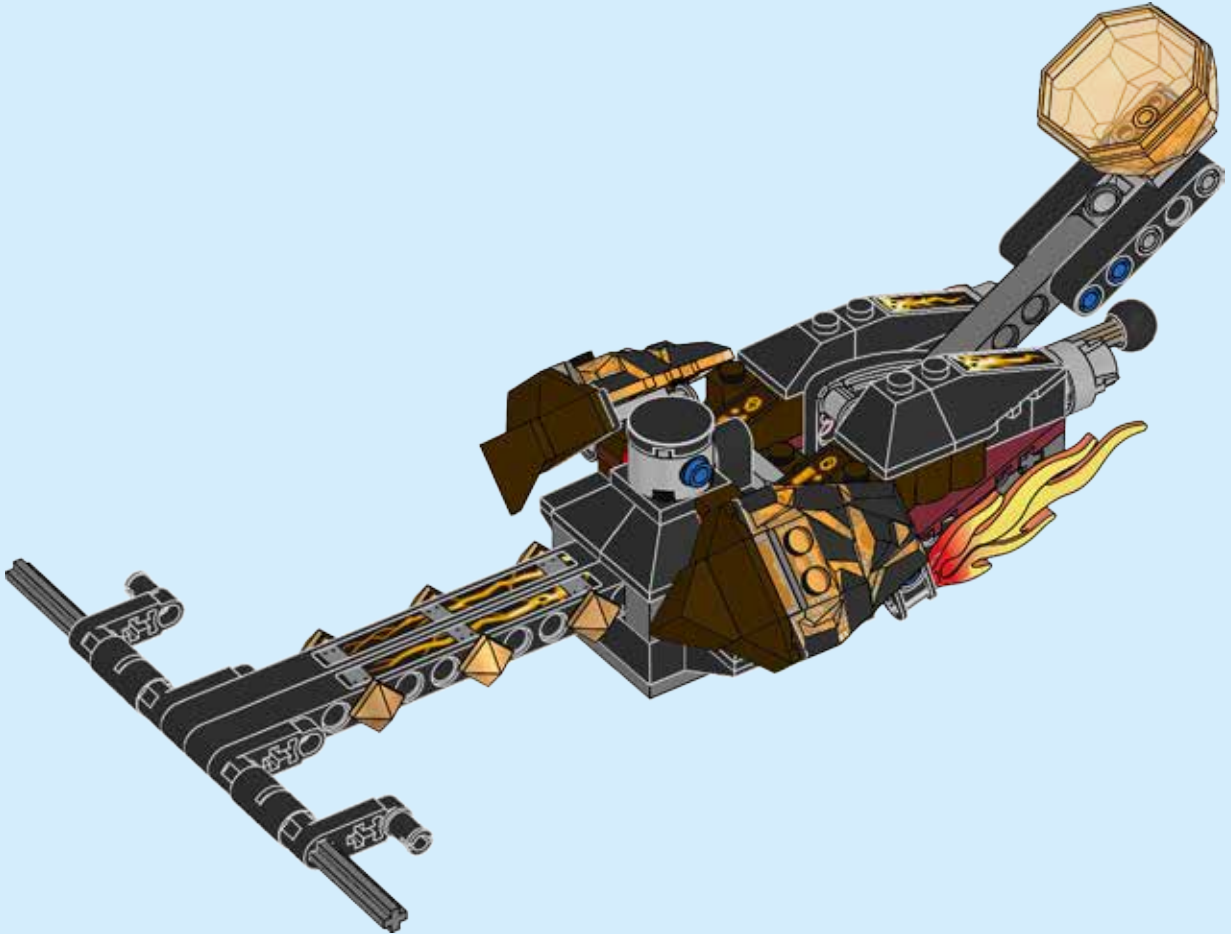



56

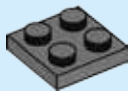

57

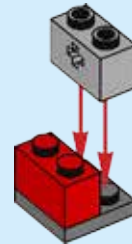

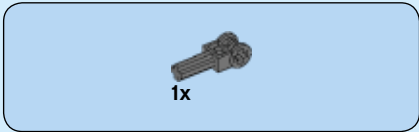

58

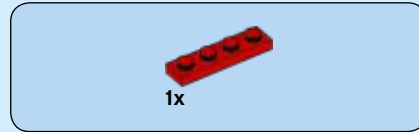
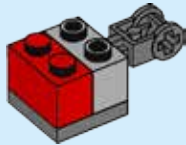

59

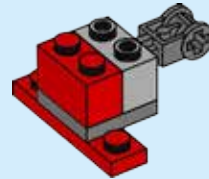





2x

# 60

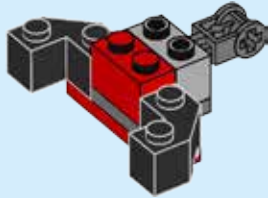

2x

# 61

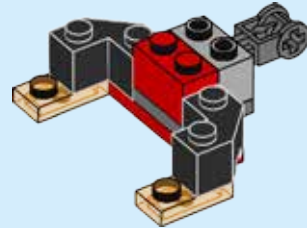



2x

# 62

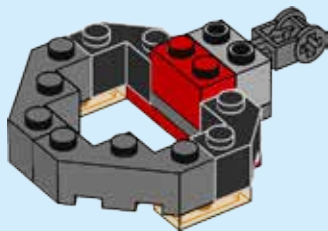

1x

# 63

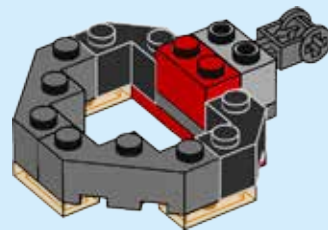



2x

# 64

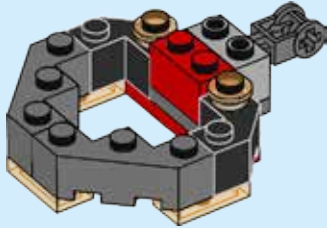

3x

# 65

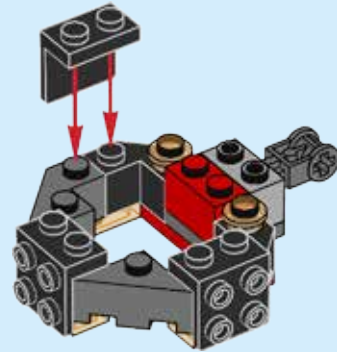

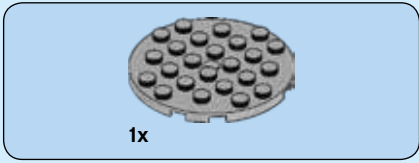

66

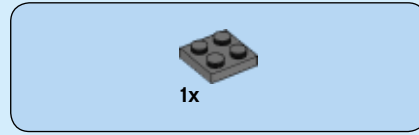
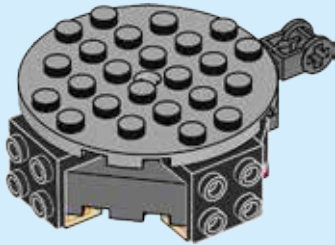

67

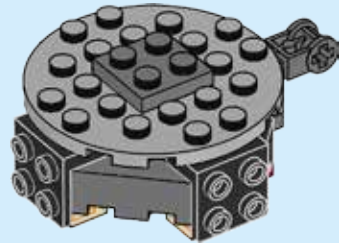

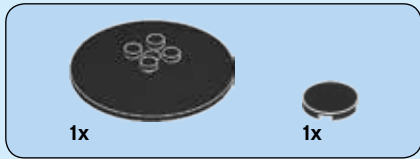

68

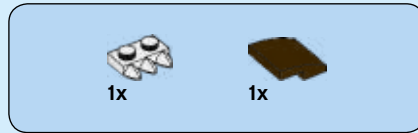
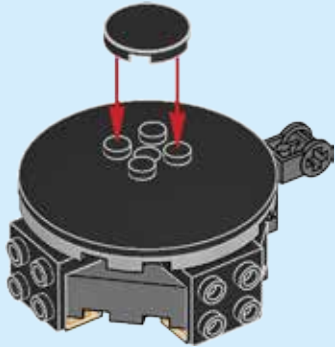

69

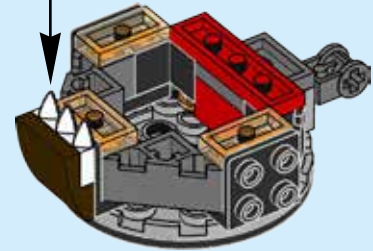
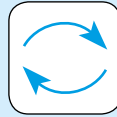

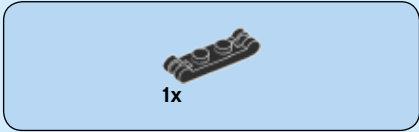
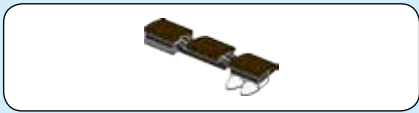

70

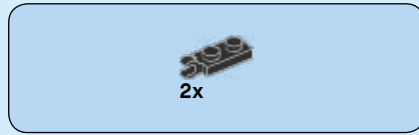
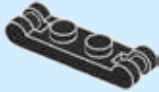

71





3x

# 72

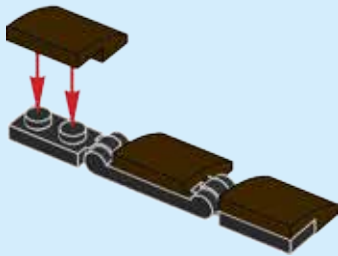

1x



2x

# 73

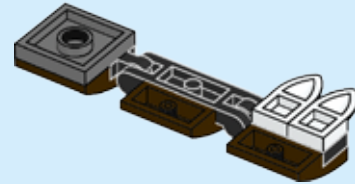
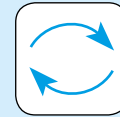



74

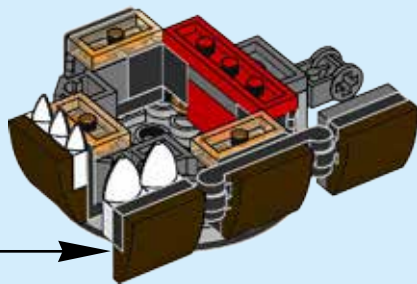



1x

# 75



2x

# 76

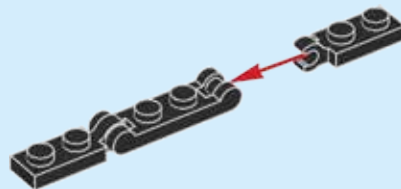



3x

# 77

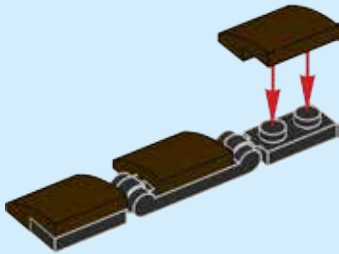

1x



2x

# 78

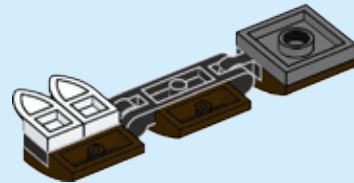
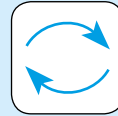

79

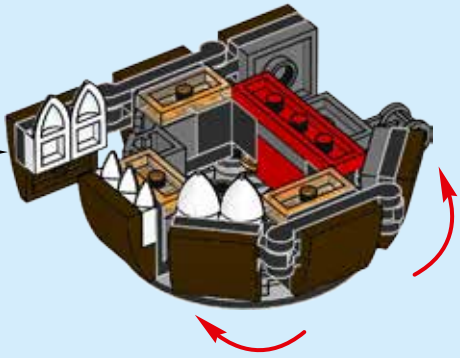

80

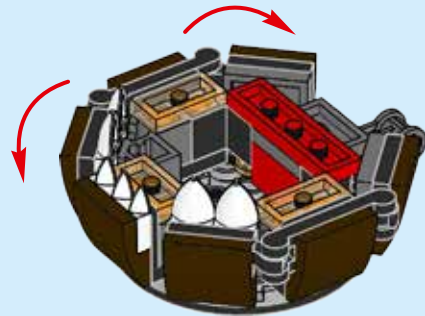

2x

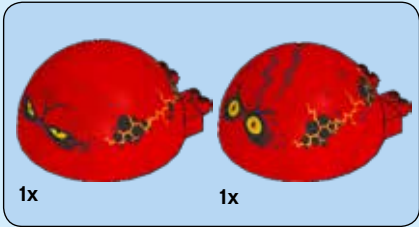
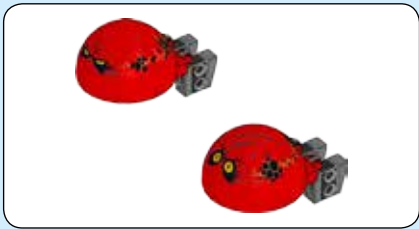

81





4x



4x



4x

# 82

1

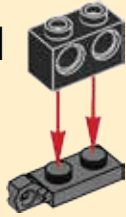

2



4x

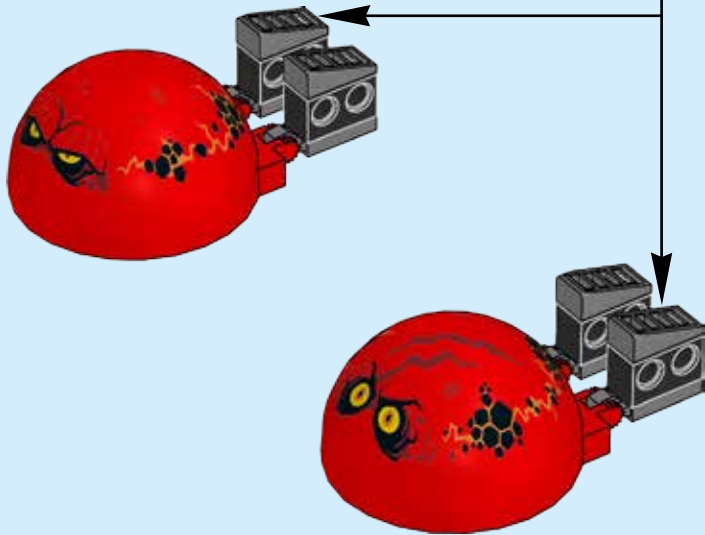

# 83

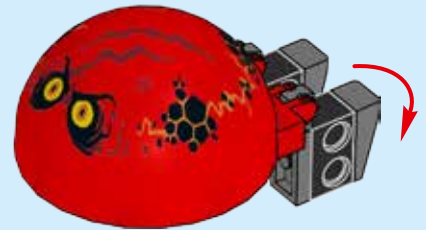
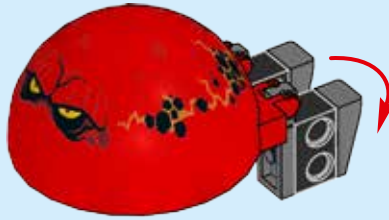

84

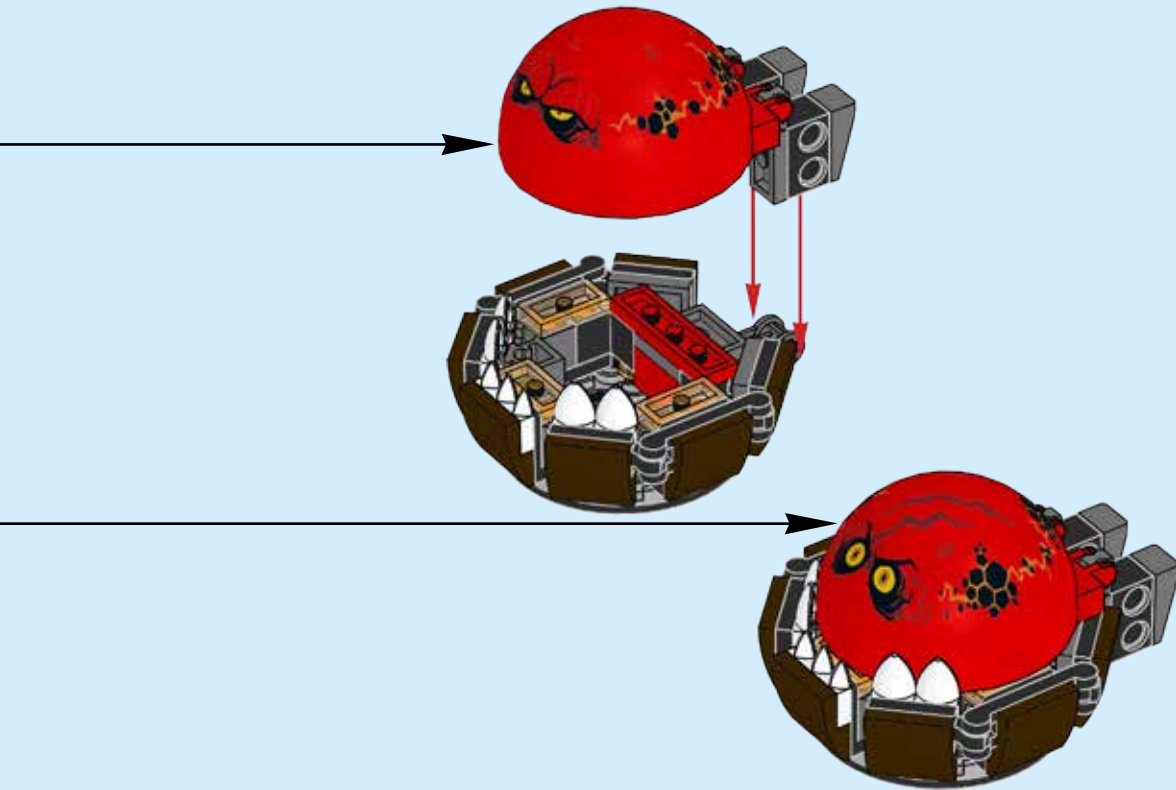



85

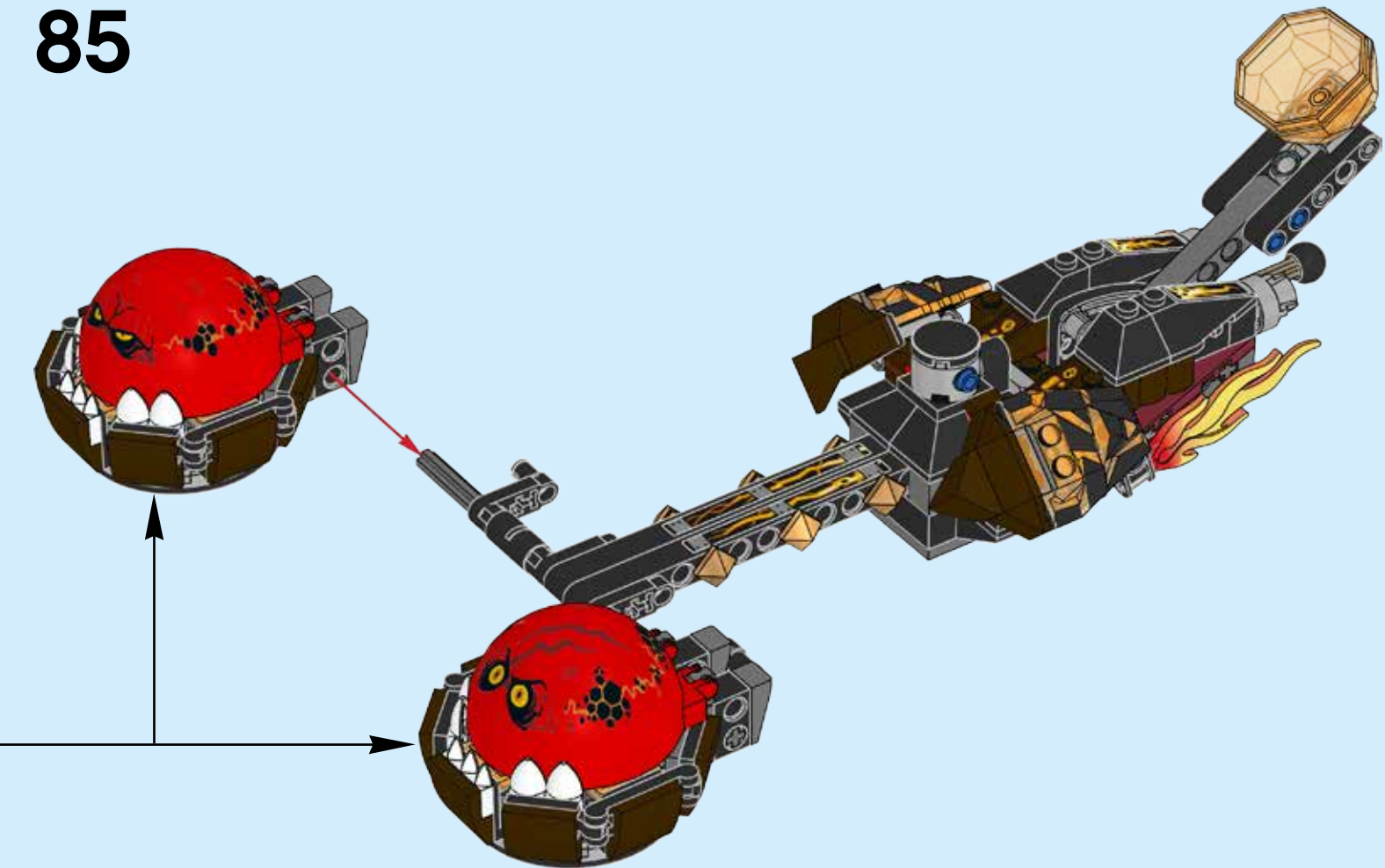

2x

# 86

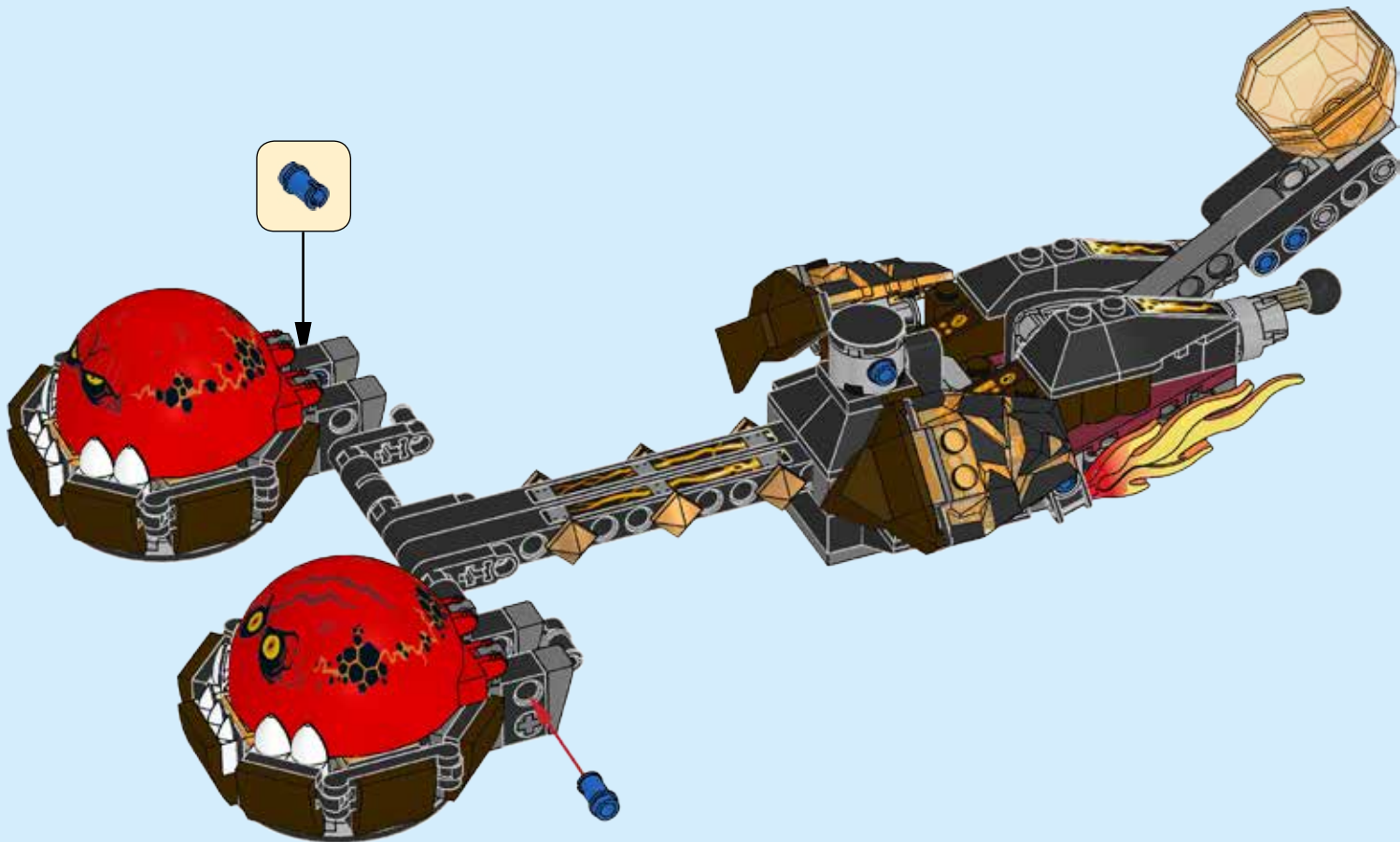

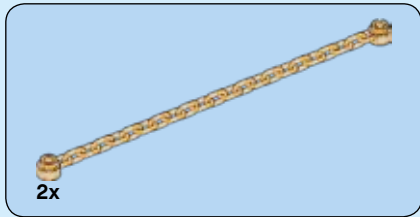

87

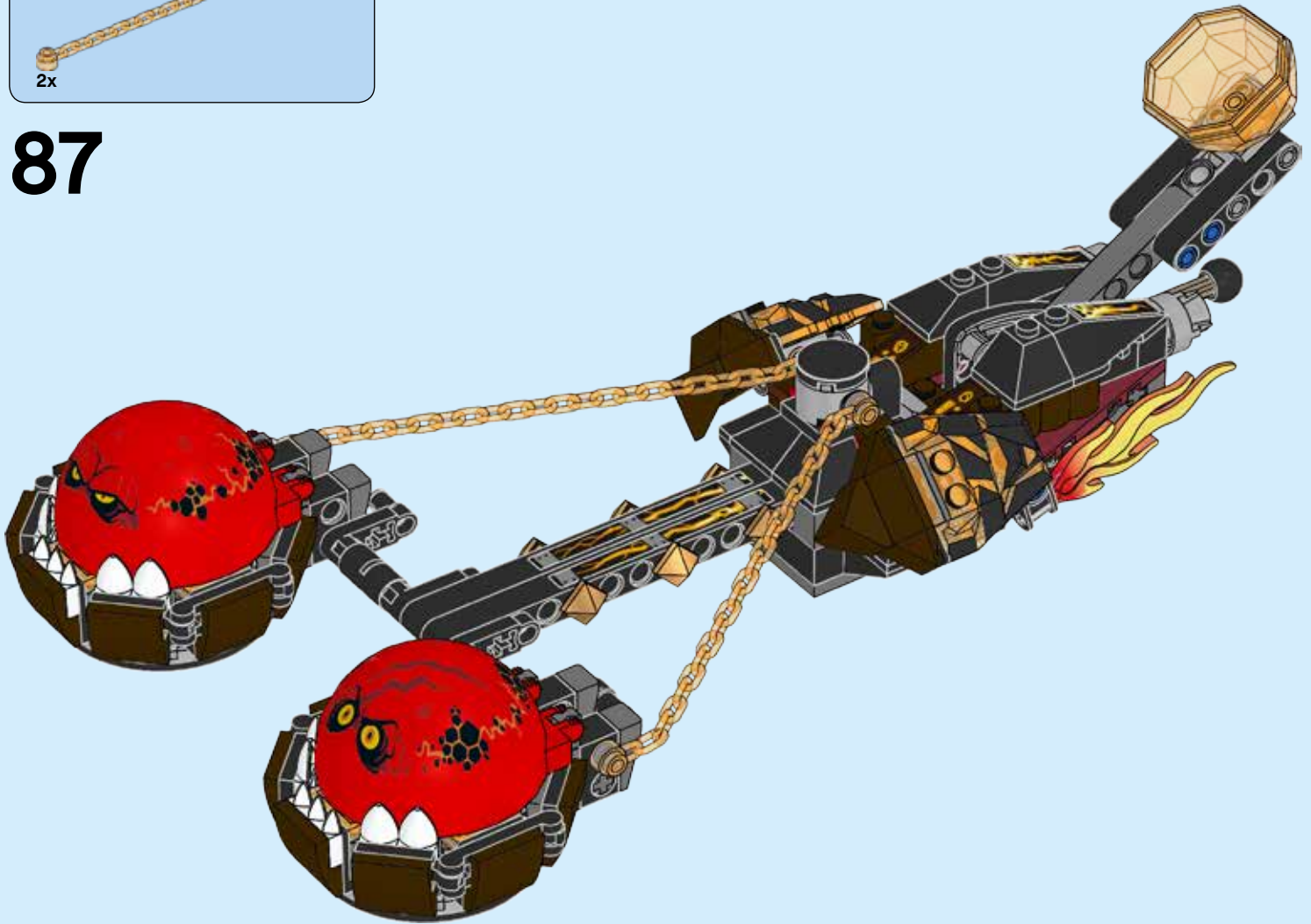

1x 1x 2x



88



89

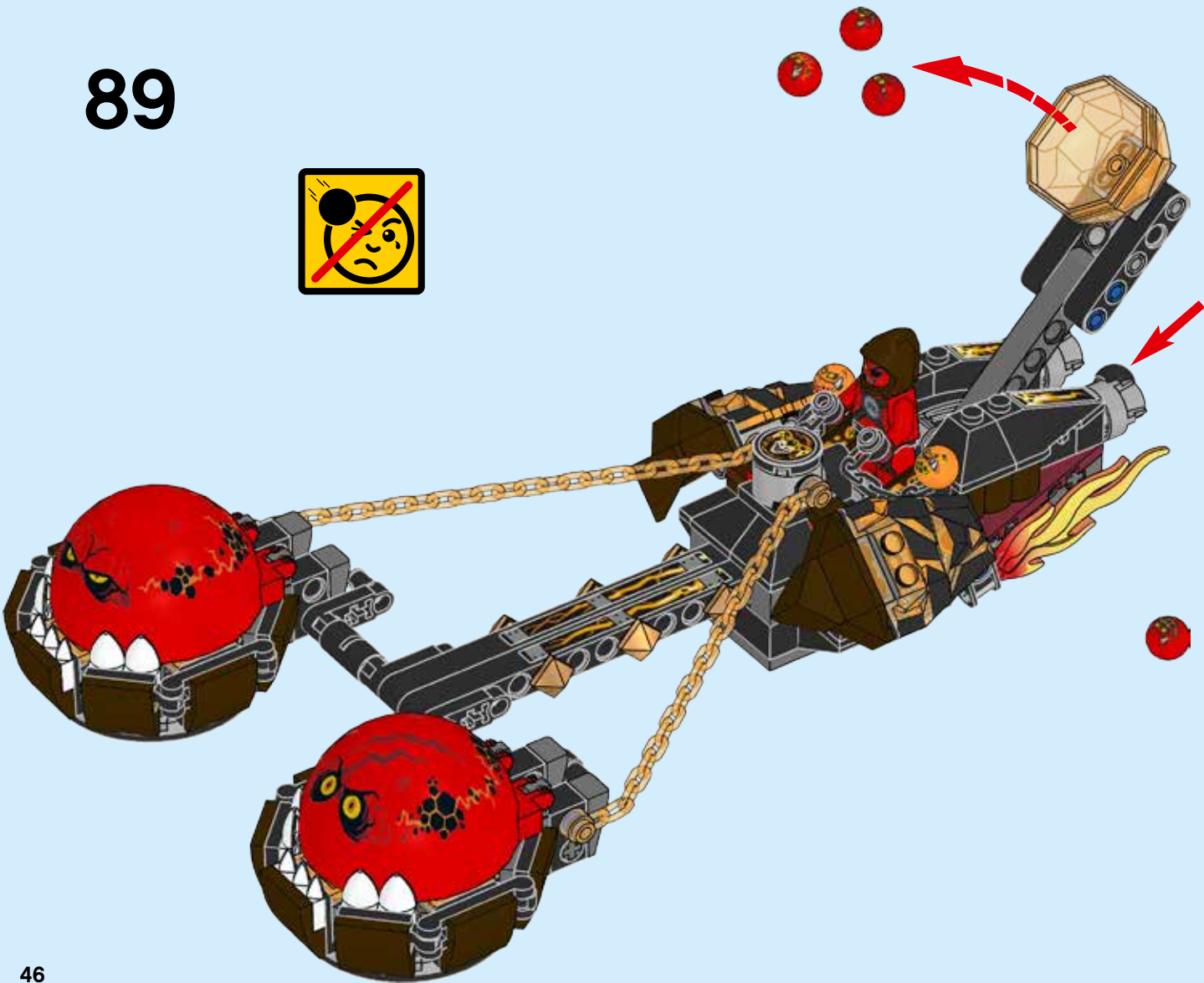



90

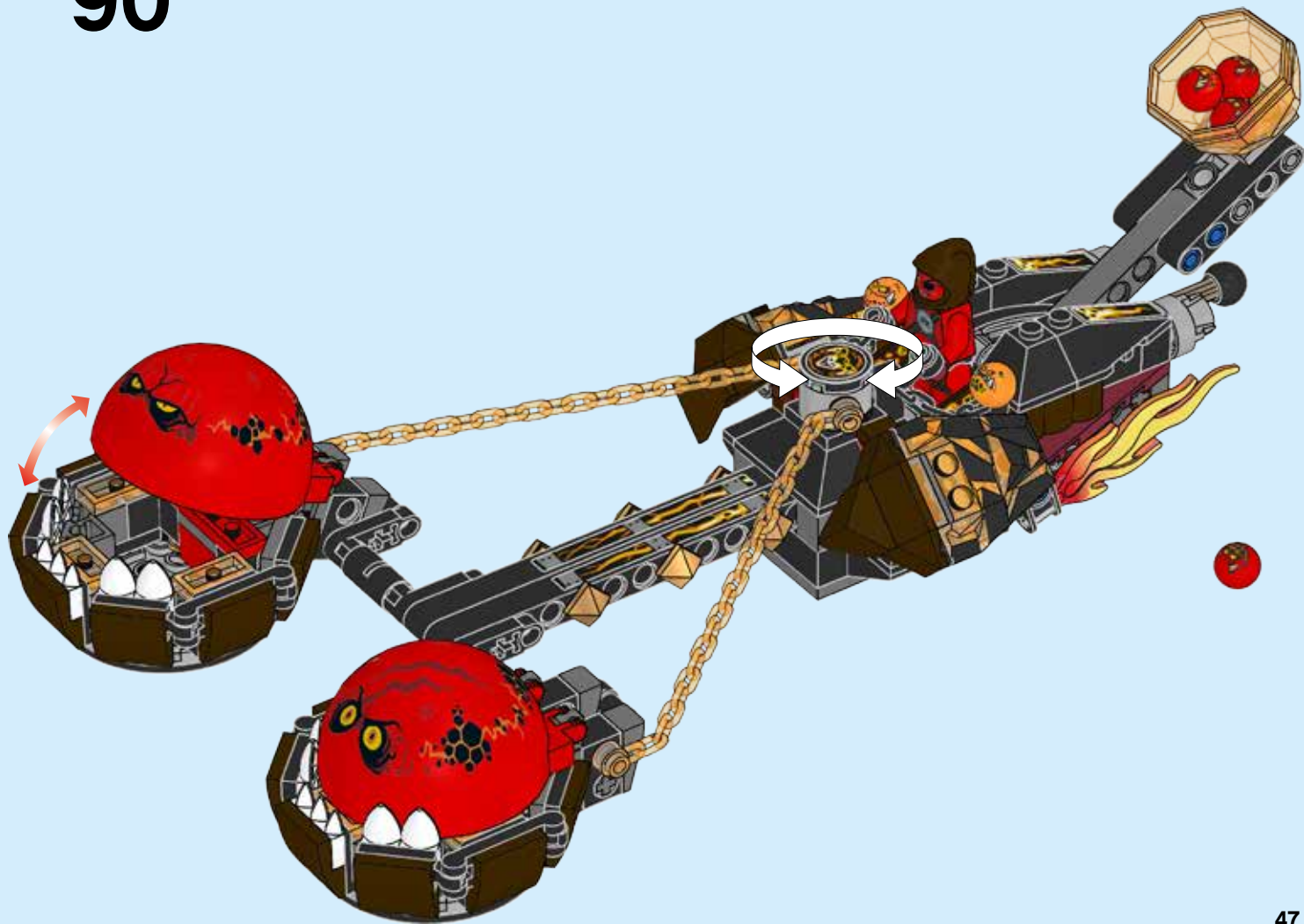

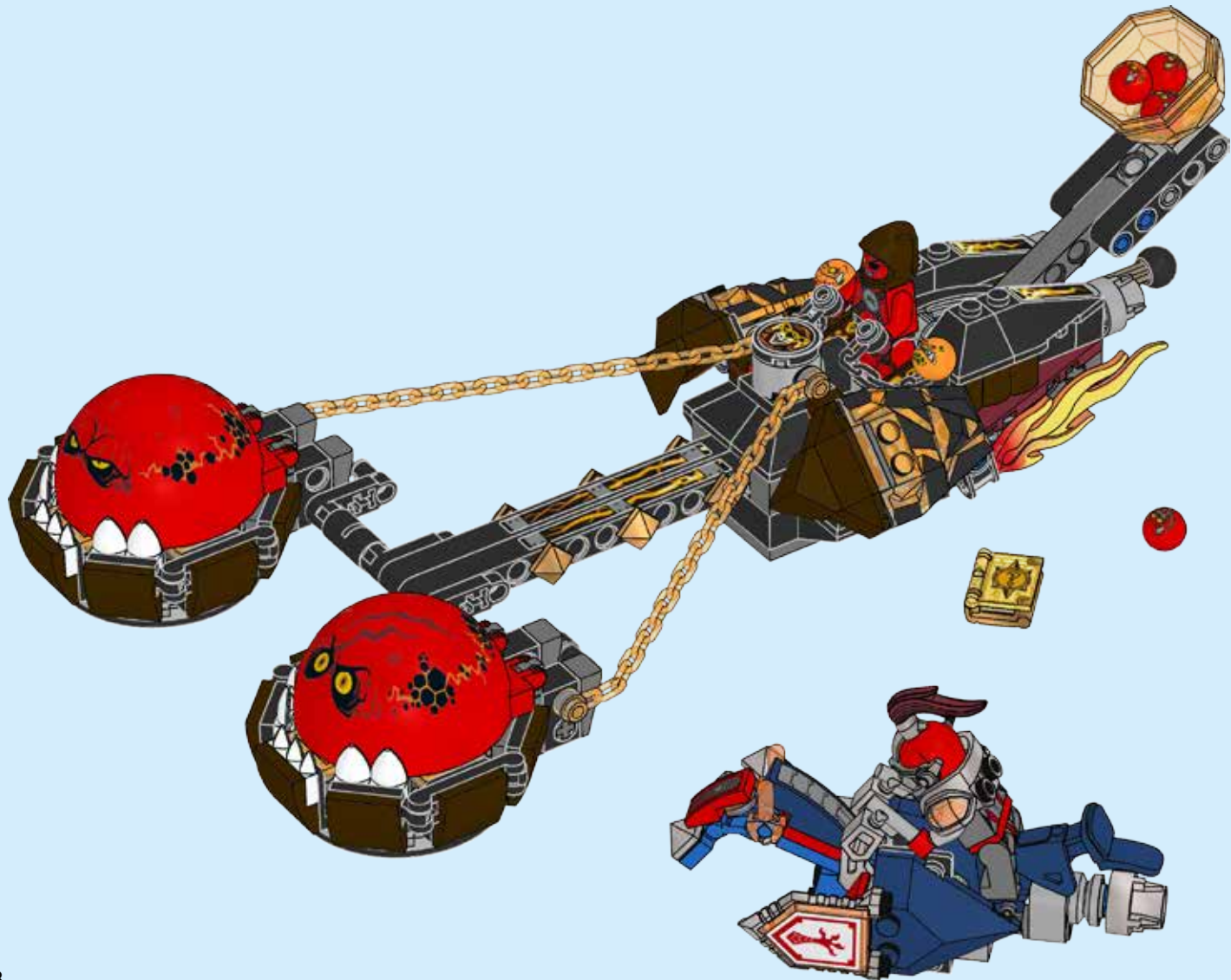





# NEXO KNIGHTS



DOWNLOAD  
THE FREE APP



LEGO® NEXO KNIGHTS™: MERLOK 2.0



1



2



3

DOWNLOAD THE FREE APP / KOSTENLOSE APP HERUNTERLADEN / TÉLÉCHARGE L'APPLI GRATUITE  
DESCARGA LA APP GRATIS / DESCARREGA A APP GRÁTIS / TÖLTSD LE AZ INGYENES APPOT / 下載免費APP  
DEVICE CHECK / GERÄT PRÜFEN / VERIFICATION DE COMPATIBILITE :  
COMPRUEBA TU DISPOSITIVO / VERIFICAÇÃO DO DISPOSITIVO / ESZKÖZZELLENÖRZÉS / 設備檢查

[LEGO.com/devicecheck](http://LEGO.com/devicecheck)



# NEXO KNIGHTS

## SCANNING TIPS

Scanning Tips / Tipps zum Scannen / Conseils de scannage /  
Consejos para escanear / Dicas para o scan /  
Beolvásási tippek / 扫描秘诀







# NEXO KNIGHTS



LEGO  
LEGOLAND  
DISCOVERY CENTER

# LEGOLAND



DOWNLOAD THE FREE APP; KOSTENLOSE APP  
HERUNTERLADEN; TÉLÉCHARGE L'APPLI GRATUITE ;/  
DESCARGA LA APP GRATIS; DESCARREGA A APP GRATIS;/  
TÖLTSD LE AZ INGYENES APPOT!; 下载免费 APP;  
LEGO® NEXO KNIGHTS™: MERLOK 2.0

ALL MATERIALS MIGHT NOT BE  
AVAILABLE IN ALL MARKETS.  
MÖGLICHERWEISE IST NICHT DAS GANZE MATERIAL IN ALLEN  
MÄRKTEN VERFÜGBAR; CERTAINS PRODUITS PEUVENT NE  
PAS ÊTRE DISPONIBLES SUR CERTAINS MARCHÉS; CIERTOS  
MATERIALES PODRÍAN NO ESTAR DISPONIBLES EN TODOS  
LOS MERCADOS; OS MATERIAIS PODERÃO NÃO ESTAR TODOS  
DISPONÍVEIS EM TODOS OS MERCADOS; ELKÉPZELHETŐ,  
HOGY BIZONYOS KIEGÉSZÍTŐK A TE ORSZÁGODBAN NEM  
ELÉRHETŐEK; /部分内容可能不适用于某些国家/地区

LEGO.COM/NEXOKNIGHTS



**LEGO**

# NEXO KNIGHTS









6x  
6129416



1x  
6138666



1x  
4540280



2x  
6129858



1x  
6018481



1x  
6129756



2x  
6132361



1x  
6129616



1x  
6125657



2x  
4504379



1x  
4298617



1x  
4142865



2x  
4632572



1x  
6125709



2x  
300421



1x  
6029946



1x  
6117974



1x  
4534648



1x  
6124855



2x  
300221



3x  
371021



1x  
6132202



1x  
6132205



1x  
4290713



2x  
4558954



1x  
473326



3x  
6070695



3x  
4173668



6x  
4121715



2x  
4526982



1x  
4144024



4x  
3200026



2x  
366526



4x  
6000650



2x  
4542573



6x  
6117973



4x  
4563044



8x  
4535739



1x  
368026



6x  
4189064



2x  
6089577



4x  
6099483



5x  
374726



3x  
301026



4x  
4584274



1x  
6040298



2x  
4128557



1x  
6040297



2x  
4142135



2x  
6062698



1x  
4161266



2x  
6058341



1x  
4161281



1x  
6133120



1x  
6134219



1x  
4539068



1x  
4539069



1x  
6125685



4x  
4222960



10x  
4280341



1x  
6120912



2x  
6132333



2x  
6132438



**Customer Service**  
**Kundenservice**  
**Service Consommateurs**  
**Servicio Al Consumidor**  
**LEGO.com/service or dial**

**: 00800 5346 5555**  
**: 1-800-422-5346**



# WIN

GO TO [WWW.LEGO.COM/PRODUCTFEEDBACK](http://WWW.LEGO.COM/PRODUCTFEEDBACK) AND  
GIVE US YOUR SHORT **FEEDBACK** ABOUT THIS  
LEGO® SET FOR A CHANCE TO WIN  
A COOL LEGO PRIZE.



## LEGO.com/productfeedback

### GEWINNE



Erzähle uns auf  
[www.LEGO.com/productfeedback](http://www.LEGO.com/productfeedback)

etwas über die Erfahrungen, die du mit  
diesem LEGO® Set gemacht hast, und  
sichere dir die Chance auf einen coolen  
LEGO Preis!

### GAGNE



Rends-toi sur  
[www.LEGO.com/productfeedback](http://www.LEGO.com/productfeedback)

et donne-nous quelques commentaires  
sur ce produit LEGO® pour avoir une  
chance de gagner un prix LEGO !

### GANAN



Visita  
[www.LEGO.com/productfeedback](http://www.LEGO.com/productfeedback)

y envíanos tu opinión acerca de este set  
LEGO®. ¡Participarás en el sorteo de un  
premio LEGO!

### 获取奖品



登录  
[www.LEGO.com/productfeedback](http://www.LEGO.com/productfeedback)

给出关于此乐高®套装的简短反馈，  
就有机会获得炫酷乐高奖品