

**Roco**

Die Innovation der Modellbahn

H0  
H0e  
TT



# multiMAUS

10810

Manual

GB

# Table of Content

The evolution of the ROCO Lokmaus — the <b>multiMAUS</b>	32
An overview of the <b>multiMAUS</b>	32
<b>Section 1 ■ Basics – Get to know the multiMAUS</b>	
Connecting the <b>multiMAUS</b>	33
The Display Screen	34
The Keys	34
Operating the <b>multiMAUS</b>	36
1. Start	36
2. Type of locomotive access	36
3. Driving and functions	39
4. The emergency stop functions	40
5. Turnout control	40
6. Quick programming	42
7. Short circuit and overload	43
<b>Section 2 ■ The Menus – Programming for advanced users</b>	
The menu functions of the <b>multiMAUS</b>	44
Overview of the menu structure	45
1. The “Loco” Menu	47
2. The “Program” Menu	49
3. The “Settings” Menu	50
<b>Section 3 ■ Appendix – Useful information about the multiMAUS and the subject of digital technology</b>	
<b>multiMAUS</b> Compatibility – all useable devices	53
Using Locomotives without a Digital decoder and <b>multiMAUS</b>	53
The master-and-slave principle	54
Combination of digital and non-digital system parts	54
The 10765 Booster	55
Terminal Loops in Digital Operation	56
Glossary	56
Hints, Tips and Help	57
Programming Help for Lokmaus 2 / R3 – <b>multiMAUS</b>	58
Error Messages	59
Fig. 1–5: Connection options	60 – 64

## The evolution of the ROCO Lokmaus — the multiMAUS

The **multiMAUS** brings together the functionality of the legendary Lokmaus with the comfort of a fully digital central control unit. Whether you use the **multiMAUS** as just a comfortable controller or wish to use it for comprehensive programming of your locomotive decoder and turnouts, the clear layout of the design and simple operation make the **multiMAUS** the leading digital model railroading controller.

Our aim when developing this Lokmaus was to make operation as intuitive as possible. The addition of the various new functions can be easily controlled. This manual is designed to introduce you to all the capabilities of the **multiMAUS**.

In order to make this manual clear and easy to understand, it is broken down into several sections. Beginning users that wish to use the **multiMAUS** only for playing are not required to read the entire manual. The first section is sufficient for simple, everyday use.

This first section of the manual deals with the basics for connecting and operating the **multiMAUS**. Users who wish to use the many diverse programming options of the **multiMAUS** will find instructions in the second section of this manual. The third section serves as a guide for special cases involving digital model railroading. The glossary contains the definitions of basic terms that you may encounter while spending time with your digital system.

Have fun reading this manual and, of course, using the **multiMAUS**.

Modelleisenbahn GmbH

## An overview of the multiMAUS

### The concept

- Ergonomic shape for one-hand operation
- Large LCD with backlight
- Simple methods for setting speed and direction of travel of the locomotives using the rotary knob
- Rotary knob with zero locking position
- Multilingual operation
- Compatibility with other DCC / NMRA-compatible controllers
- The ROCO digital system is expandable to include up to 31 input devices such as extra Lokmaus or multi-MAUS devices, RouteControl etc.
- Future updates via RS485 and ROCOMOTION (X-Bus)

### The features

- Managing 9,999 locomotive addresses & Deciding between locomotive library or locomotive address
- Alphanumerical locomotive name display with locomotive database for 64 entries, i.e. locomotives
- Locomotive control with 14, 28 and 128 speed steps which can be set for each locomotive individually
- Control of light and 20 additional functions for locomotives
- Control up to 1,024 turnout addresses
- Writing configuration variables (DCC-CVs)

### Safety

- Emergency stop with shut-down of the entire system
- Emergency stop for the selected locomotive
- Child lock for functions which may could be problematic for children (e.g. programming)

## Section 1 ■ Basics

## Connecting the multiMAUS

Fig. 2 on page 61 shows the basic connection. For a fully-functional ROCO digital system with the **multiMAUS**, you will need the following components:

- A 10764 amplifier,
- A 10851 switching power supply,
- And a 61190 feeder track. If you are using another feeder track or system, make sure that there is no capacitor in the feeder track.

You will find information on other devices which you can use with the **multiMAUS** in the chapter “**Compatibility of the multiMAUS**” in the third section of this manual.

Please pay attention to the following instructions before you start connecting components:



The warranty will be voided if you are using ROCO components together with components from other companies. In addition there is a risk of damage or malfunction to your digital system. Your warranty will also be void if you open the housing of the **multiMAUS**.

Please only carry out any connection work with the operating voltage switched off (as an exception: connection of further X-Bus based equipment, see below). Work carefully and make sure to avoid short circuits at all costs when connecting to the track system. An incorrect connection may destroy the digital components. You should also seek the advice of a specialist or local dealer.

To operate the digital system without faults, you should avoid extending the connecting cable to the master mouse.

It is imperative that you do not connect a normal transformer on the same circuit parallel to the digital controller. This could destroy the digital booster!

1. Plug the feeder track cable into the track socket “Track Out” on the amplifier.
2. Plug the hollow plug, which is connected to the transformer by the two-pin cable, into the “Power In” socket.
3. Connect the **multiMAUS** and the amplifier using the cable included with your system. Plug the cable into the connection socket on the booster labeled “Master”.
4. You can now (and not beforehand) connect the transformer to the mains socket. This way you avoid damaging the digital system.

The socket labeled “slave” is for connecting a further **multiMAUS**, a Lokmaus 2 / R3, the RouteControl 10772 or a PC with the ROCOMOTION software. In this case you should have switched the system on. This ensures that the automatic allocation of the X-Bus addresses will be without any problems. If more than one of these devices are to be connected, you will require the data BUS distributor 10758.

If you use a Lokmaus 2 / R3 as a master, you will be unable to use some of the functions performed by a **multiMAUS** set as a slave. We therefore recommend that you use a **multiMAUS** as the master. See also the chapter “**Master-and-Slave Principle**” in the third section of this manual.

#### Note on the instructions

Text that contains an “→” before a word refers to a definition in the “**Glossary**” in section three.

“+” in the diagrams means that both the keys mentioned must be pressed together.

“/” in the diagrams stands for a selection of one of the two keys mentioned.

# The Display Screen

All the functions of the **multiMAUS** can be checked on the large LCD with backlight. The symbols are as follows:

## Drive symbols

- Arrows shows the direction of travel of the selected locomotive
- "II" denotes that the locomotive is at a standstill (by controller or selected emergency stop)

## Short circuit

- the symbol flashes in the event of a short circuit or an overload

## Stop (stop key)

- the symbol flashes in the event of an emergency stop or short circuit

## Shift symbol

- is shown as confirmation of the shift key

## Wrench

- the **multiMAUS** is in the "SETTINGS" menu level

## Turnout symbol

- (locomotive / turnout key)
- the **multiMAUS** is in the turnout mode

## Locomotive symbol

- (locomotive / turnout key)
- drive mode
- with "MENU": "LOCO" menu

## Light symbol (light / OK key)

- locomotive light switched on

## Function symbols (1–10)

- display the currently activated special locomotive functions
- showing sub-item ranks in the menu level

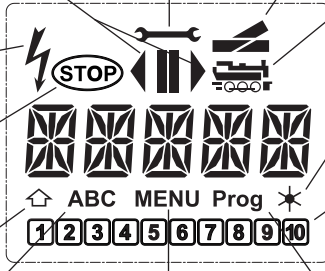

## ABC

- lights up when text is being entered

## MENU

- the **multiMAUS** is in the menu level

## Prog



- lights up as a confirmation when programming
- the **multiMAUS** is in the "PROGRAMMING" menu level













# The Keys

The clear concept of the **multiMAUS** reduces the number of the keys to an expedient quantity. Functions needed for ordinary playing can mostly be called by the particular keys. These keys will be shown here. Please also note fig. 1 on page 60.

**Note:** The "arrow keys" – like all other keys – only have one single function despite having two arrows printed on them.

When selecting key combinations using "Shift" – same as the "MENU" key – and another key, the "Shift" key has to be pressed before any other key – like on a computer keyboard.

 Arrow keys — in combination with —	<ul style="list-style-type: none"> <li>Scroll through the locomotive library (library menu)</li> <li>Search for locomotive addresses (locomotive address mode)</li> <li>Set the turnout (straight or branch-off, turnout mode)</li> <li>Scroll through a menu level</li> </ul>
 Shift key — in combination with —	<p><b>In library mode:</b></p> <ul style="list-style-type: none"> <li>Freshly arrange order of locomotives by shifting</li> </ul> <p><b>In locomotive address mode:</b></p> <ul style="list-style-type: none"> <li>Scroll 100 positions (search functions)</li> </ul> <p><b>In turnout mode:</b></p> <ul style="list-style-type: none"> <li>Scroll through the turnout numbers (search function)</li> </ul>
 menu key	<p><b>In locomotive address mode:</b></p> <ul style="list-style-type: none"> <li>Rearrange speed steps</li> </ul>

 Light / OK key	<ul style="list-style-type: none"> <li>Switch the light on or off (in drive mode)</li> <li>Confirm inputs (in turnout mode and in the menus)</li> <li>Call up desired menu level or menu items</li> </ul>
<p>— in combination with —</p>  Shift key	<p><b>In locomotive address mode:</b></p> <ul style="list-style-type: none"> <li>Select another locomotive by directly inputting an locomotive address</li> </ul>
 Stop key	<p><b>In drive mode:</b></p> <ul style="list-style-type: none"> <li>Emergency stop on entire system</li> </ul> <p><b>In menu mode:</b></p> <ul style="list-style-type: none"> <li>Return from the respective menu level</li> </ul>
<p>— in combination with —</p>  Shift key	<p><b>In drive mode:</b></p> <ul style="list-style-type: none"> <li>Selective emergency stop for the locomotive selected and displayed</li> </ul>
 Locomotive / turnout key	<ul style="list-style-type: none"> <li>Switch between locomotive and turnout mode</li> </ul>
<p>— in combination with —</p>  Shift key	<ul style="list-style-type: none"> <li>Switch between library and locomotive address mode</li> </ul>
 Function keys	<p><b>In drive mode:</b></p> <ul style="list-style-type: none"> <li>Switch the locomotive functions F1 – F10 on or off directly. The locomotive functions F11 – F20 are switched using keys 1 – 10 together with the shift key. The activated locomotive functions can be seen on the display screen.</li> </ul> <p><b>In menu mode:</b></p> <ul style="list-style-type: none"> <li>Input a locomotive name (alphanumerical) in the library</li> <li>Fast access to the menu items out of the menu level</li> </ul> <p><b>In turnout mode:</b></p> <ul style="list-style-type: none"> <li>Input turnout number directly</li> </ul>
<p>— in combination with —</p>  Shift key	<ul style="list-style-type: none"> <li>Switch locomotive functions F11 – F20 on or off. You can check the activated functions by pressing the “shift” key.</li> </ul> <p><b>In turnout mode:</b></p> <ul style="list-style-type: none"> <li>Call up to 10 saved turnouts (turnout shortcut keys)</li> </ul>
 Shift key	<p><b>In drive mode:</b></p> <ul style="list-style-type: none"> <li>Check the activated functions F11 – F20</li> </ul>
 menu key	<ul style="list-style-type: none"> <li>Switch to menu mode (press and hold for approximately 5 seconds)</li> <li>Return directly from all menu levels to locomotive / turnout mode</li> </ul>
<p>— in combination with —</p>  Shift key	<ul style="list-style-type: none"> <li>Switch to menu mode</li> <li>Return directly from all menu levels to locomotive / turnout mode</li> </ul>
<p>— in combination with —</p>  Function keys	<p><b>In library or locomotive address mode:</b></p> <ul style="list-style-type: none"> <li>Quick-program CVs 1 – 5 and 8 (“MENU” key must be pressed first)</li> </ul> <p><b>in turnout mode:</b></p> <ul style="list-style-type: none"> <li>Quick call to saved turnouts (turnout shortcut keys)</li> </ul>

# Operating the multiMAUS

Despite its numerous options, operation of the **multiMAUS** is simple and intuitive. A concept which had already been successfully introduced for the Lokmaus models of the first and second generation. The following shows you how to operate the **multiMAUS** based on practical examples.

If problems occur during operation or programming, hints, tips and error messages can be found starting on page 57.

## 1. Start

After starting up the **multiMAUS**, the display screen shows the word “**multiMAUS**” in animated lettering. The **multiMAUS** then switches to drive mode and displays the first locomotive.

### 1.1. First-time use

When connecting the **multiMAUS** for the first time, there is only one locomotive (address 3) in the library (“library mode” factory setting). The display screen shows the locomotive symbol, the standstill symbol “II” (i.e. the locomotive is stopped) together with the right arrow and the lettering “LOK 1” so that you can drive the locomotive immediately.

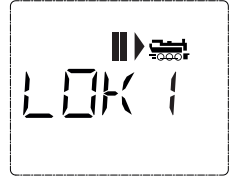

If you have purchased the **multiMAUS** with a starter set, the locomotive from the set is already fully programmed. You can also drive this locomotive immediately (section 3).

### 1.2. An already used multiMAUS

If you have already used the **multiMAUS**, the locomotive last controlled is displayed – regardless if you used the library or the address mode.

While scrolling with the “arrow keys” you see all settings of the traction operations, i.e. drive direction, name or address of the locomotive, selected functions. If you unplug and re-insert a slave **multiMAUS**, it recognizes this information unlike a master **multiMAUS**, which only shows the standstill symbol “II” and the right arrow.

## 2. Type of locomotive access

The **multiMAUS** has two locomotive access options:

- Using the factory-set library mode: see section 2.1.
- Using address mode, i.e. using the locomotive address directly: see section 2.2.

You switch between the modes by pressing the “shift” key together with the “locomotive / turnout” key.

### 2.1. Library mode

**Locomotive library mode** is a database which gives you the option of saving 64 locomotives with a name (5 characters), locomotive address and the required speed steps. Entries are only saved in the **multiMAUS** and not in the locomotive decoder.



The decoder locomotive address therefore always has to be changed using “CV1” (see “Quick-programming” on page 42). You will be required to make the changes in the library as well.

**Screen display** (in the example, the “S 3/6” series steam locomotive):

- Locomotive name (in this case “S 3/6”) and loco symbol,
- Direction of travel (in this case: the locomotive was or is stopped, the arrow shows the last direction of travel),
- Light (in this case: the locomotive lighting is switched on),
- F1 and F4 (in this case: the activated locomotive functions).

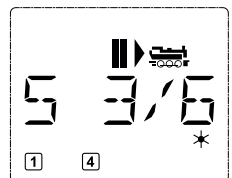

calling up other locomotives already entered in the library (“scrolling”)

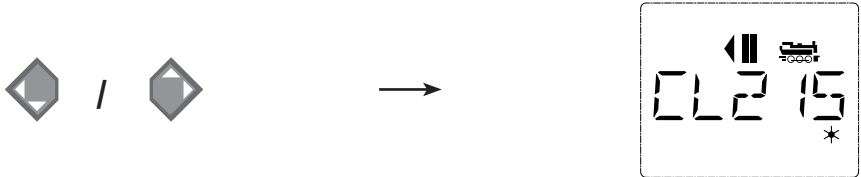

Locomotives in the library are **sorted** in the order in which they were entered. You can of course change this order:



These key combinations (press keys together) move the locomotive up or down in the library. You can check the new order for the library with the arrow keys.

**Entering a new locomotive** (in the example, the DR 120 series “Taigatrommel” diesel locomotive):

Input	Display message	Comment
		You can find the free memory slot marked “NEW ?” by scrolling through the library using the arrow keys. Confirm by pressing “OK”.
		You then enter the locomotive name. 5 characters are available. In our example we have abbreviated “Taigatrommel” to “TAIGA”. The first character is displayed with a flashing cursor.
		You use the “function keys” 1–0 to make the input in the same way as writing a text message on a mobile phone: Press the respective key repeatedly until the desired character appears. The cursor flashes and freezes briefly after the correct character has been entered before jumping to the next character place.
		To enter a space, press the “0” key once, to get the “0”, press the key twice. Special characters (/, -, \, *, [, ], <, >) can be entered by repeatedly pressing the “1” key. Correct input errors by using the left “arrow key” to move back one or more spaces.
		Confirm by pressing “OK” The <b>multiMAUS</b> then switches to the locomotive address. The “suggested value” is displayed, in this case “3”.



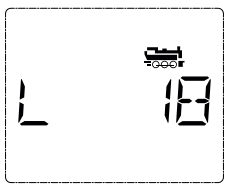
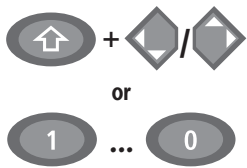

Change the suggested value by either using the “shift” key and one of the “arrow keys” or by entering the number directly using the “function keys”. This change only affects the library name order! You must change the decoder address using CV1 (see section 6, page 42).

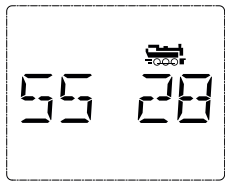

Confirm by pressing “OK”  
You select the → speed steps using the “arrow keys”. You have 3 options available. 14, 28 or 128 speed steps. The factory setting is for 28 speed steps. If you have selected a preset in the “SETTINGS” menu, this will appear on the display screen.

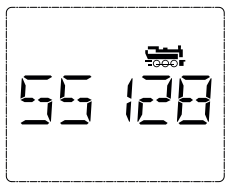

If you switch to 128 speed steps, you can control your locomotive with a particularly high level of sensitivity. Modern decoders give you the option of fine control.  
If you do not wish to make a change, simply press “OK”.

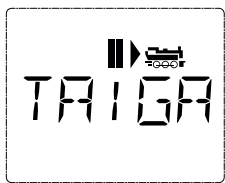

When you press the “OK” key for the final time, you are finished entering the locomotive in the library. Just check whether the locomotive address in the library is identical to the address saved in the locomotive decoder. Re-program the locomotive address as necessary (see section 6, page 42). The locomotive can now be controlled.

## 2.2. Locomotive address mode

The multiMAUS also gives you the option of controlling your locomotives using the decoder address only. The display screen shows the locomotive address with the letter “L” before it (in this case, locomotive address 36), the locomotive symbol and all the selected functions.

You can select another locomotive (address) in two different ways:

- using the “arrow keys”,
- directly, by entering the number with the function keys after having pressed the “shift” and the “Light / OK” keys at the same time.

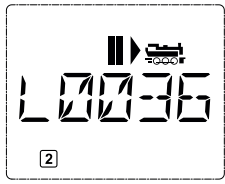

Changes to the speed steps can either be made in the “LOCO” > “EDIT” menu (see section 2 “Menu functions”) or using the key combination “MENU” and one of the “arrow keys”. You make the switch using one of the arrow keys. To return to locomotive address mode, press the “STOP” key.

You can use the → “Smart-Search function” to help you when searching for an address using the “arrow keys”. When the “arrow key” is pressed and held, the search process stops briefly at the last selected locomotives before continuing.

Information on how to program a new locomotive address using CV1 can be found in section 6, page 42.

### 3. Driving and functions

If you have selected a locomotive from the library or are directly using the locomotive address, it is immediately ready to drive. You can determine the direction of travel and the speed by turning the large controller. Both the direction of travel and a standstill are shown on the display screen above the locomotive name or locomotive address.

If the locomotive is at a standstill (display "II"), the last direction of travel is also shown. Thus it is easy to discern whether the locomotive lighting is switched on correctly, i.e. white light for the front of the train, red light at the rear.

#### Backwards

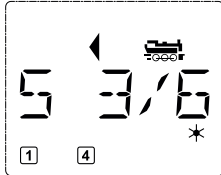

#### Standstill

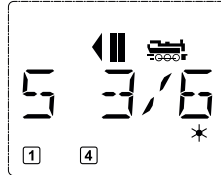

#### Forwards

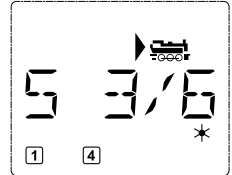

If another **multiMAUS** or Lokmaus is used to control a locomotive, the locomotive symbol flashes. See also the chapter **"The master-and-slave principle"** on page 54.

The **locomotive functions**, e.g. the noises of a sound locomotive, are activated using the „function keys“.

You can trigger the first 10 functions directly by pressing the corresponding keys. For functions F11–F20 you must press the respective function key together with the "shift" key. The display shows the activated functions.

In the figures above functions F1 and F4 are shown as examples. You can check the activated functions of the second level (F11–F20) by pressing the "shift" key.

In the following figure, F12 and F20 are activated. The arrow "⇧" stands for the multiplier of tens, i.e. is interpreted as "1" for F11–F19 and as "2" for F20.

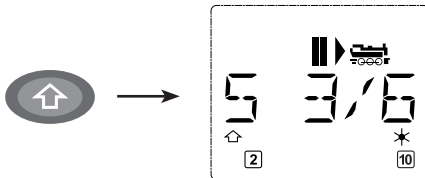

See the operating manual for the functions which are available for your locomotive.

You switch the **locomotive light** on or off using the "Light / OK" key. The star "★" at the bottom right of the display lights up to confirm that the locomotive lighting is switched on.

#### On

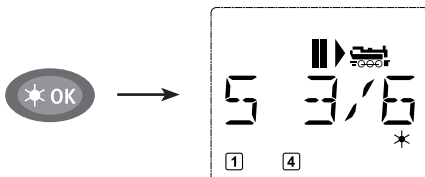

#### Off

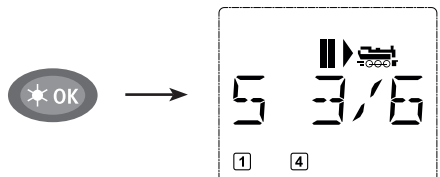

#### 4. The emergency stop functions

When a situation becomes dangerous: You can use the “STOP“ key at any time to prevent a more serious calamity immediately. In order to avoid shutting down the entire system however, you can use the “selective locomotive stop” function to stop only the locomotive selected and displayed.

##### 4.1. Emergency stop

Pressing the “STOP” key immediately cuts the voltage to the track. The STOP symbol flashes on the display screen. Press the “STOP” key again to supply the system with voltage again.

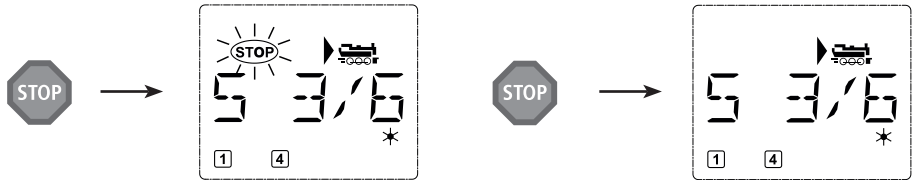

##### 4.2. Selective locomotive stop

The selective locomotive stop only stops the locomotive currently being controlled by the **multiMAUS**.

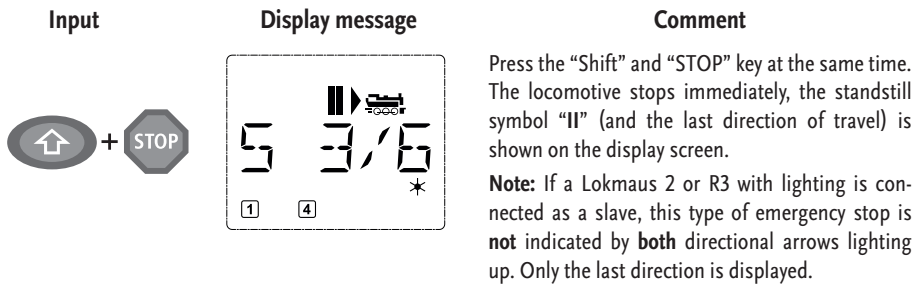

The locomotive stop is released by turning the controller, the locomotive starts to move again.



#### 5. Turnout control

You can use the **multiMAUS** to control up to 1,024 digital turnout drives with genuine turnout addresses without having to use up a locomotive address (as is the case with the Lokmaus 2 / R3). To do so, you can switch to turnout mode and back at any time by pressing the “Locomotive / turnout” key. The last turnout used is always shown.

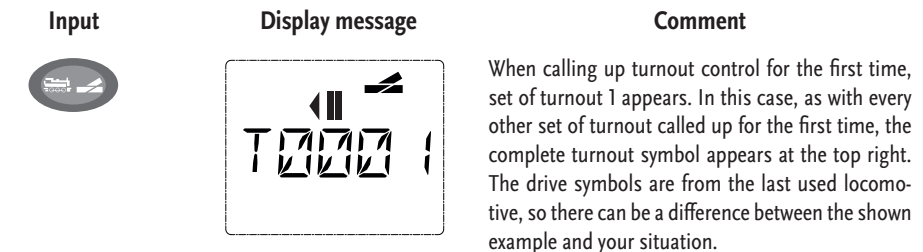

Drive mode is not interrupted in turnout mode. So the drive symbols of the last used locomotive are shown on the display. However, the last locomotive to be active can be controlled using the controller and an emergency stop can also be triggered.



You use the function keys to enter the turnout address and the “arrow keys” to switch the drive to set the turnout to “straight-on ” (left arrow key) or “branch-off ” (right arrow key).

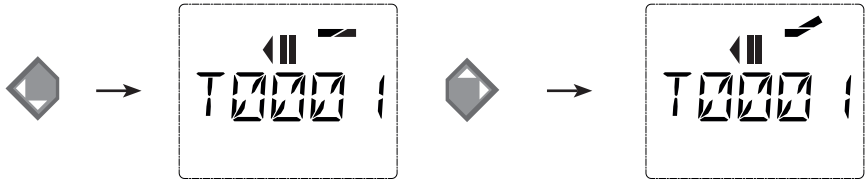

The turnouts are switched over the moment you press on of the “arrow keys”. This also saves the turnout setting. The first free numbers after the “T” are set as “0” as confirmation (of course, for 1, 2 or 3 digit turnout addresses only).



The display of the turnout positions on the screen does not denote a response from the turnout drive. The only way to check whether the turnout has actually changed is to check the turnouts themselves.

You can now exit turnout mode by pressing the “Locomotive / turnout” key or call up and switch another set of turnouts by entering the address. If you call up another turnout address, the cursor and the entered number flash alternately until the turnout has been switched using the “arrow keys”.

Example: You wish to drive a locomotive (travel direction left) to branch off at turnout no. 24.

### Input

### Display message

### Comment

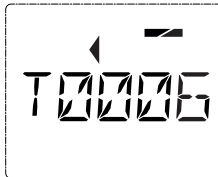

After the “Locomotive / turnout” key has been pressed, the **multiMAUS** switches from drive mode (library or locomotive address mode) to turnout mode.

The turnout last called up always appear. In this case, turnout “6”, position “straight-on”.

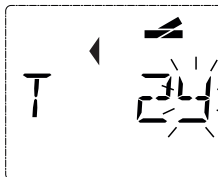

The flashing cursor indicates that the turnout address can be entered. You enter the address “24” using the “function keys” “2” and “4”.

If the turnout has not yet been switched, the complete turnout symbol appears in the display.

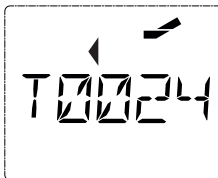

Press the right “arrow key” to switch the turnout. You may hear an acoustic confirmation depending on the turnout drive in use. The vacant digits between “T” and the address “24” are filled with a “0”.

**Note:** Pressing the key for a long time may damage or destroy older turnouts which do not have a cut-off.

Press the “Locomotive / turnout” key again to return to drive mode (library or locomotive address mode).



### Three useful multiMAUS aids for the turnout mode:

#### Toggle mode

You can switch between the current turnout and the turnout last called up by pressing the “Light / OK” key. This provides you with quick access to two sets of turnouts which, for instance, are next to each other on a stretch of track.

#### Address scrolling

Press the “shift” key and one of the “arrow keys” at the same time and the **multiMAUS** will scroll through all the turnout addresses.

#### Turnout short-cut keys

For quick access you can store the 10 most frequently used turnouts as a short-cut function on the “function keys”. To do so, proceed as in the following example:

- Turnout 5 and 14 are to be made available for activation using “function keys” 1 and 2. First call up turnout 5 as usual in turnout mode. Press the “MENU” key and “function key” 1 together and confirm with the “Light / OK” key.

Then call up turnout 14. Press the „MENU“ key and “function key 2” together again and confirm with the “Light / OK” key.

You can now call up these two sets of turnouts at any time by pressing the “shift” key and the respective “function key”. You can switch the turnouts by using the depressed “switch” key together with the respective “function key”.

In the factory setting, the turnouts 1–10 are set to the “function keys” with the same numbers (turnout 10 = “function key” 0). You can overwrite this saved order.

## 6. Quick programming

The most important decoder settings for drive mode, known as configuration variables → CVs, can be made using the combination of “MENU” + “function key”.

CV1 = Locomotive address (A change to this value has a direct effect on the decoder but not on the locomotive library. The address saved there has to have the same value as the CV.),

CV2 = Minimum speed,

CV3 = Acceleration,

CV4 = Braking time

CV5 = Maximum speed,

CV8 = Reset **all** decoder data to the factory settings.

You can perform quick programming in both “library mode” and “locomotive address mode”. All changes to CVs 1–5 only have an effect on the locomotive in digital operation.



The **multiMAUS** cannot read CVs when used in conjunction with ROCO amplifiers 10764 and 10761 and therefore a fictitious value is displayed for the CV called up. To read CVs, use, for instance, a PC with ROCOMOTION 10785 or Lenz devices.

ROCO decoders already installed in locomotives are delivered with the suitable settings. You should therefore check before performing programming whether it is really necessary.

Programming has to be performed on a separate programming track unless there is only one digital locomotive or turnout decoder connected to the booster by the tracks or other wiring or if the **multiMAUS** is switched to “POM” mode (see section 2). If programming is performed on the normal driving track and there is more than one digital locomotive on the track (or other turnout decoders than ROCO articles 42624 and 10775), the settings for all decoders in the system are changed with one single program command. Thus you could, for instance, unintentionally program all decoders to the same locomotive address.



To program on the separate programming track, either connect a stretch of track which is electrically isolated from the rest of the system to the track output on the booster or switch off the rest of the system with a switch before programming.

Example: To program the locomotive address = CV1 to value 4:

### Input

### Display message

### Comment



Press the "MENU" key and "function key" 1 together.

The display screen briefly shows the selected CV and then switches immediately to display the fictitious suggested value.

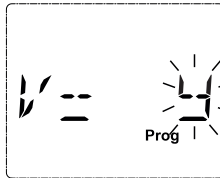
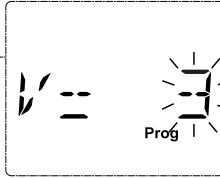

The displayed fictitious suggested value is easily overwritten by pressing one of the "function keys". The cursor flashes.



Confirm by pressing "OK". After the last display "PROG" the **multiMAUS** returns to drive mode.

**Note:** If you have changed CV1 for a locomotive, check whether the specification of the locomotive's address in the library matches.

You can also program new values for CV 2, 3, 4 and 5 as shown in this example. To do so, you simply press the "Menu" key together with the „function key“ with the number corresponding to the CV and then proceed as in the above example.

If you set value "8" in CV8 (no other value can be entered), all the decoder's CVs are reset to the factory setting.

## 7. Short circuit and overload

If a short circuit or an overload occurs on the system, the **multiMAUS** indicates this using two flashing symbols on the display screen: a streak of lightning and the STOP symbol. At the same time the voltage supply to the system is shut off. If there is a short circuit, e.g. because of a derailed coach or train, eliminate the fault.

Press the "STOP" key once to switch the system back on with a delay of approximately one second.

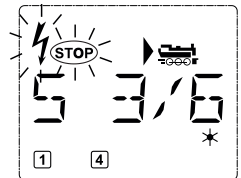

If the fault is not a short circuit, the cause may be an overload of the system due to the operation of several locomotives at a time. If this occurs frequently, the power supply to your system is insufficient. Connect an additional booster (section 3 "THE 10765 BOOSTER", page 55). You must not under any circumstances use a normal transformer connected directly to the power supply as this will destroy the **multiMAUS** and booster.

## Section 2 ■ The Menus

GB

### The menu functions of the multiMAUS

The **multiMAUS** has three main menus with which you can both perform comprehensive programming and change the basic settings of the **multiMAUS**. This menu levels can be accessed using two simple key combinations:

- Press the “MENU” key on its own for approximately 5 seconds (the duration can be set in the “SETTINGS” menu), practically single-handed operation of the **multiMAUS**,
- Press the shift and “MENU” key together.

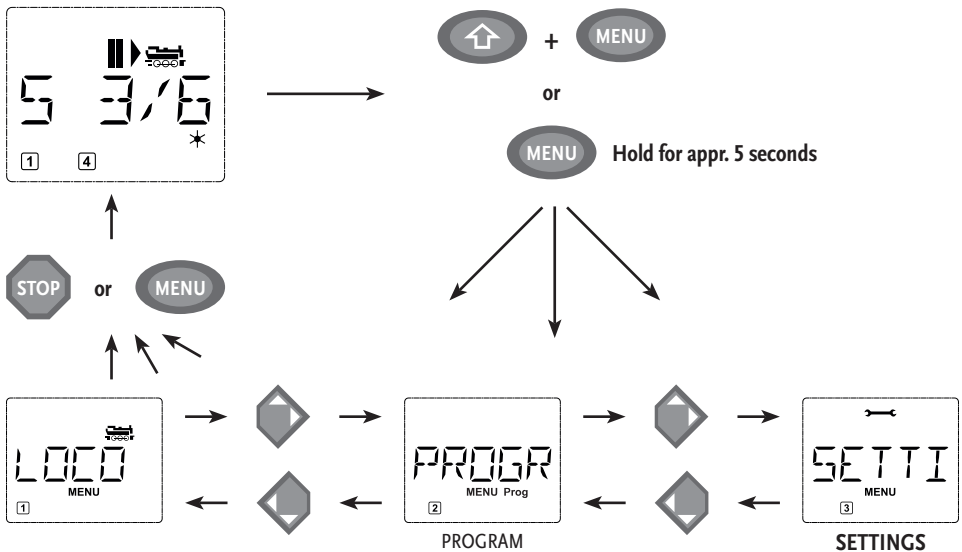

A locomotive cannot be controlled whilst the **multiMAUS** is in menu mode. Internal communication with another **multiMAUS** or other DCC devices is however assured.



A scrolling text program which is integrated in the **multiMAUS** displays all the menu names with more than 5 letters as scrolling text. In the display figures in this manual the abbreviated menu name is shown. The complete name is shown directly underneath the figure.

You use one of the “arrow keys” to continue in the menu level. You use the “light / OK” key to call up the respective submenu. The menus are all numbered. The numbers are shown at the bottom of the display.

Each of the three large main menus has its own pictograms for clear identification. They appear in addition to the word “MENU”. You will also find them in the respective submenus:

- Menu 1 “ENGINE”: Symbol “”,
- Menu 2 “PROGRAMMING”: Lettering “**Prog**”,
- Menu 3 “SETTINGS”: Symbol “”.

There are two ways to exit the menu level:

- Press the “STOP” key. You may need to do this several times depending on the submenu which you are currently in. Each time you press “STOP” you go back one level.
- Press the “MENU” key (alone or together with the shift key) to exit **all levels** immediately and return to locomotive and turnout mode.

All of the menus of the **multiMAUS** can be found in the large overview on the next two pages.

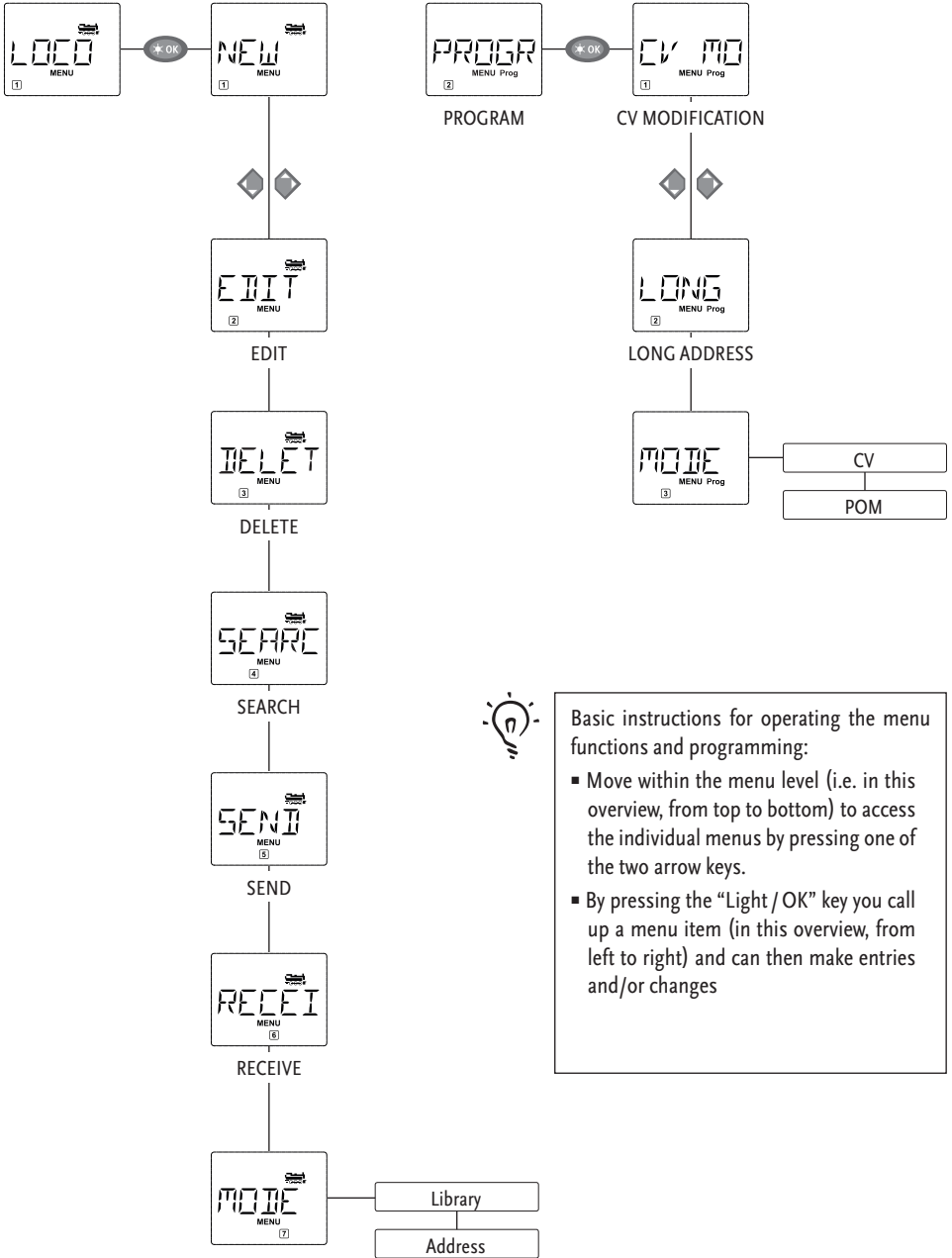

Basic instructions for operating the menu functions and programming:

- Move within the menu level (i.e. in this overview, from top to bottom) to access the individual menus by pressing one of the two arrow keys.
- By pressing the “Light / OK” key you call up a menu item (in this overview, from left to right) and can then make entries and/or changes



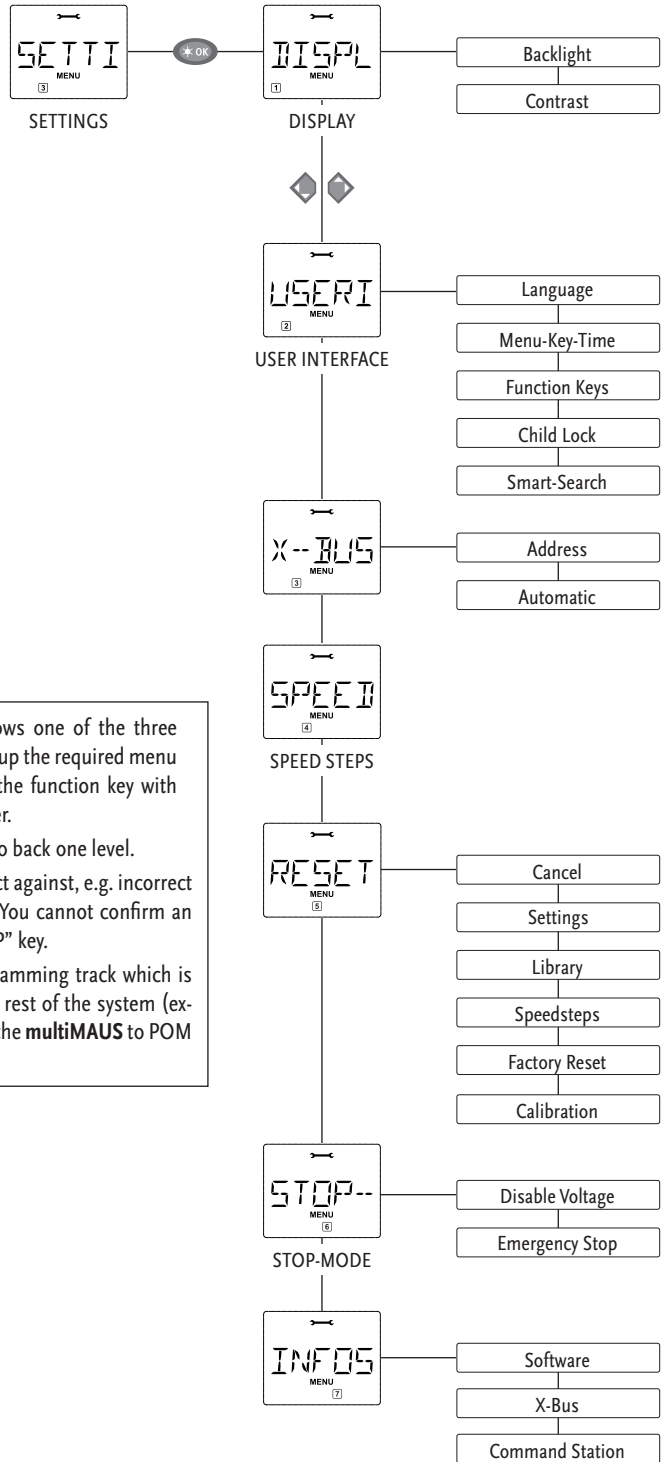

- If the display screen shows one of the three main menus, you can call up the required menu item by simply pressing the function key with the corresponding number.
  - Press the “STOP” key to go back one level.
- For your safety and to protect against, e.g. incorrect call-up or incorrect inputs: You cannot confirm an input by pressing the “STOP” key.
- Always program on a programming track which is fully disconnected from the rest of the system (exception: you have switched the **multiMAUS** to POM mode (page 49)).

## 1. The “Loco” Menu



The **multiMAUS** uses the “LOCO” menu to manage all data which is required for the locomotive library and for identification of a locomotive. You can also use this menu to set the **multiMAUS** to library or address mode.



### 1.1. “NEW“

You can use this menu item to enter a new locomotive in the library. The sequence is principally as described and displayed in the first section on page 37.

In the first step you enter the locomotive name and have 5 digits available to do so. The first display screen shows a flashing cursor. You can now use the “function keys” to enter the locomotive name (letters and / or numbers) in the same way as you use the keypad of a mobile phone. Once you have entered a letter / a number, wait a moment until the cursor jumps to the next digit.

Press “0” once to enter a space. To make corrections use the left arrow key.

- To confirm, press the “Light / OK” key.

In the next screen you enter the locomotive address using the function keys. The flashing “3” can be overwritten. Press the shift together with one of the arrow keys to search for and select the locomotive address.

- To confirm, press the “Light / OK” key.

You select the → speed steps in the next screen using the arrow keys (3 options).

- Press the “Light / OK” key to confirm the input and complete programming. The **multiMAUS** exits menu mode and returns directly to locomotive mode.



### 1.2. “EDIT“

You change the data for a locomotive in the library using this menu item.

If, for example, only the locomotive address is changed but the name and speed steps remain unchanged, you can skip these items without editing them by pressing the “Light / OK” key. The first screen shows the locomotive last used in locomotive mode. You select the locomotive for which you wish to make changes, using the arrow keys.

- To confirm, press the “Light / OK” key.

You now have the option of changing the locomotive name. The cursor flashes in the last place. You use the left arrow key to delete letters / numbers and can re-enter them using the “function keys”.

- To confirm, press the “Light / OK” key.

You can correct the locomotive address as previously described.

- To confirm, press the “Light / OK” key.

You correct the speed steps using the “arrow keys”.

- To confirm, press the “Light / OK” key. You return to the start level “EDIT”.



A change to the locomotive address in the library has no effect on the address stored in the locomotive decoder. It can be changed using “CV1”. See the chapter “Quick programming” on page 42 and “Changing CVs” on page 49.

## 1. The “Loco” Menu



### 1.3. “DELETE”

You use this menu item to remove a locomotive from the library.

The first screen shows the locomotive last used in locomotive mode. Use the “arrow keys” to select the locomotive you wish to remove.

- To confirm, press the “Light / OK” key.

The scrolling text “DELETE LOCO?” appears in the next screen.

- To confirm the deletion, press the “Light / OK” key. You return to the start level “DELETE”.

The locomotive is removed from the library and, if it is still travelling, is stopped automatically (selective emergency stop). The locomotive can only be controlled using locomotive address mode until it is entered in the library again.



### 1.4. “SEARCH”

This could be one of the most important functions of your **multiMAUS**. You can use this menu item to assign a locomotive address to the corresponding locomotive in the library.

Simply enter a locomotive address using the “function keys” and the **multiMAUS** will find the corresponding locomotive in the library.

- Press the “Light / OK” key to confirm the entry. The **multiMAUS** returns directly to locomotive mode and display the assigned locomotive.

If the **multiMAUS** does not find the corresponding locomotive for the address, “ERR 9” appears in the display. You can use the “STOP” or “Light / OK” key to return to the start level “SEARCH”.



### 1.5. “SEND”



### 1.6. “RECEIVE”

You require both of these menu items when you wish to transfer the locomotive library from one **multiMAUS** to another **multiMAUS** (or several **multiMAUS** devices). To do so, you set the transmitting **multiMAUS** to “SEND” and the other **multiMAUS** or **multiMAUS** devices to “RECEIVE”. You start the transmission by pressing the “LIGHT / OK” key on the transmitting **multiMAUS**. When the transfer is complete, the receiver **multiMAUS** is in library mode, the transmitting **multiMAUS** is at the start level “SEND”.



### 1.7. “MODE”

You can either control a locomotive from library mode as set in the factory or simply using the locomotive address. You can select which of the settings you prefer using this menu item.

You select the respective mode using one of the “arrow keys”. The modes are displayed in scrolling text.

- To confirm, press the “Light / OK” key. You return to the start level “MODE”.

## 2. The “Program” Menu



All the values of a decoder (NMRA / DCC) are stored in what are referred to as configuration variables, the →CVs. Using the “PROGRAM” menu you can adjust these values to your needs.

ROCO decoders already installed in locomotives are usually delivered with the suitable settings. You should therefore check before performing programming whether it is really necessary.

The ROCO amplifiers 10761 and 10764 and booster 10762 and 10765 cannot read the CVs from a decoder. The values shown on the display screen of the **multiMAUS** are fictitious suggested values and **do not match the genuine values**. The values which your program, on the other hand, are the genuine values. Use either devices capable of reading (e.g. a PC with ROCOMOTION 10785 or a Lenz booster) or write down the old and new decoder values. See the instruction manual for your decoder or locomotive.



### 2.1. “CV MODIFICATION“

This is where you can read CVs (see above) or give them new values. The first display screen shows the text “CV” and a flashing cursor. You can now enter the number of the CV you require using the „function keys“.

- To confirm, press the “Light / OK” key.

The displayed value is either fictitious, a suggested value or – when using a booster which can read – the current genuine value. If you only wish to read the values, exit the menu item by pressing “STOP”.

- Then enter the required value and confirm by pressing the “Light / OK” key. The display switches briefly to “PROG” before you return to the start level “CV MODIFICATION”.



### 2.2. “LONG ADDRESS“

Only locomotive addresses from 1 – 99 can be stored in CV1. All locomotive addresses from 100 onwards must be programmed using this menu item. To do so it is first necessary to enable “long addresses” in the locomotive decoder using CV29 (see decoder operating manual!)

When calling up this menu item, “CV 17 / 18” is briefly displayed. The display then switches immediately to a four digit “suggested value” with a letter “L” prefix and a flashing cursor. You can now enter the number of the address you require using the function keys. The numbers of the suggested value disappear once the first number has been entered.

- To confirm, press the “Light / OK” key. The display switches briefly to “PROG” before you return to the start level “LONG ADDRESS”.



### 2.3. “MODE“

The **multiMAUS** is set to “CV programming mode” in the factory. However, if you wish to program locomotives without using a separate programming track, set the **multiMAUS** to „POM“ mode. “POM” stands for “programming on the main” which means that you can program the locomotive, which is selected on the **multiMAUS**.

A decoder reset may need to be performed. See “**Hints, Tips and Help**” on page 57. CV1 (address) for the locomotive being programmed cannot be programmed in “POM” mode. Select the required programming mode using one of the arrow keys.

- To confirm, press the “Light / OK” key. You return to the start level “MODE”.

### 3. The “Settings” Menu



The most extensive **multiMAUS** menu contains all the data which is practical, useful or sometimes necessary for basic operation of the **multiMAUS**. We would also like to point out at this point that the **multiMAUS** is provided with all the necessary settings in the factory so that you have to use this main menu either rarely or not at all.



#### 3.1. “DISPLAY“

This is where you find the setting options which affect the display screen.

3.1.1. The sub-item “BACKLIGHT” regulates the strength of the backlight of the display screen which can be particularly useful in dark rooms. You select the desired strength using the “arrow keys”.

**Value range:** 0 (off) – 15, **Factory setting:** 15

- To confirm the input, press “Light / OK” key. You return to the start level “BACKLIGHT”.

3.1.2. You use the second sub-item “CONTRAST” to regulate the contrast of the display screen. You also select this value using the arrow keys.

**Value range:** 0 (very weak) – 15 (very dark), **Factory setting:** 12

- To confirm the input, press “Light / OK” key. You return to the start level “CONTRAST”.



#### 3.2. “USERINTERFACE“

You can make individual operating settings for the **multiMAUS** here.

3.2.1. The **multiMAUS** is usually shipped set to the respective country’s language. You can call up another national language using the submenu “LANGUAGE”. Select your language using the “arrow keys”. If your national language is not included, visit the ROCO website [www.roco.cc](http://www.roco.cc) for an update.

- To confirm, press the “Light / OK” key. You return to the start level “LANGUAGE”.

3.2.2. The “MENU-KEY-TIME” is the amount of time you have to press the “MENU” key in order to exit drive mode and access menu mode on the **multiMAUS**. You can set the duration you require in seconds using the “arrow keys”.

**Value range:** 0 – 10, **Factory setting:** 5

If the value is set to “0”, you can only access the **multiMAUS** menu mode by pressing the “shift” key and the “menu” key at the same time.

- To confirm, press the “Light / OK” key. You return to the start level “MENU-KEY-TIME”.

3.2.3. The “FUNCTION KEYS” are used to activate locomotive functions (F1– F20, e.g. the horn on a locomotive with sound or a digital coupling) by pressing the corresponding function key for an extended time (at least 1 second). The function remains active for as long as you hold the “function key”. If you press the key only briefly, the desired function is activated normally. You select the desired status using the arrow keys.

**Factory setting:** OFF

- To confirm, press the “Light / OK” key. You return to the start level “FUNCTION KEYS”.

### 3. The “Settings” Menu



3.2.4. The **multiMAUS** has „CHILD LOCK“ which can be set to multiple levels and can be activated after calling up the menu item using the „arrow keys“.

To block an area, you will need to enter a code which is comprised of 4 numbers (no letters!). The password is then always requested when you wish to call up a protected area of the **multiMAUS**.

**Factory setting:** OFF

- “DISABLE MENU”: The three main menus cannot be called up;
- “DISABLE PRG-MENU”: The quick-programming mode is also blocked;
- “DISABLE LIB-PRG-MENU”: All changes to the locomotive library are also prevented in addition to both items mentioned above.

Each input has to be confirmed by pressing the “Light / OK” key.

3.2.5. “SMARTSEARCH” provides you help when searching for locomotive addresses (see also the corresponding chapter in section 3).

**Factory setting:** ON

- Confirm the selection you have made with the “arrow keys” by pressing the “Light / OK” key. You return to the start level “SMARTSEARCH”.



3.3. “X-BUS“

“X-BUS” is the connection language which digital components such as the **multiMAUS** use to communicate with one another. An advanced user can use the two sub-items “ADDRESS” and “AUTOMATIC” to set all information and settings (for more information see the glossary in section 3).

However, we would like to point out that it is not usually necessary to make any changes in this menu item. This may only be necessary if the **multiMAUS** is being used in connection with digital devices made by other manufacturers.

3.3.1. When you call up the sub-item “ADDRESS”, the current X-Bus address is displayed. You can simply overwrite it.

**Value range:** 0 – 31, **Factory setting:** 27 (master **multiMAUS** only)

- To confirm, press the “Light / OK” key. You return to the start level “ADDRESS”.

3.3.2. “AUTOMATIC” does exactly what it is supposed to: It searches for a free X-Bus address for the **multiMAUS** in a digital system.

**Factory setting:** ON

- Confirm the selection you have made with the “arrow keys” by pressing the “Light / OK” key. You return to the start level “AUTOMATIC”.



3.4. “SPEEDSTEPS“

The “SPEED STEPS“ presetting with which the **multiMAUS** controls the locomotive decoder is made in this menu item (for more information on the subject of “SPEED STEPS” see the glossary in section 3). Please see the respective operating manual to determine which speed steps your decoder has.

You can select between 14, 28 and 128 speed steps using the arrow keys.

**Factory setting:** 28

- To confirm, press the “Light / OK” key. You return to the start level “SPEED STEPS”.

### 3. The “Settings” Menu



#### 3.5. “RESET”

The **multiMAUS** is a particularly user-friendly digital controller and can be reset to the factory settings, not just completely but also partially.

- 3.5.1. “CANCEL” can be regarded as the emergency exit from this menu item.
- 3.5.2. When the “SETTINGS” are reset, all entries in the “Settings” menu are reset to factory settings. The locomotive library remains intact. If calibration has been performed (see 3.5.6.), it will have to be repeated after the reset.
- 3.5.3. Select this sub-item if you wish to delete the “LIBRARY”.
- 3.5.4. Select “SPEED STEPS” to reset the selection made in menu item 3.4 to the factory setting.
- 3.5.5. You can use “FACTORY RESET” to reset your **multiMAUS** completely to the original status. Any entries made are deleted.
- 3.5.6. You will not normally have to “CALIBRATE” the **multiMAUS** as this is performed on delivery. However, in the event of extreme temperature variations, the controller may need to be re-adjusted, e.g. if a locomotive travels in the zero position. To do so, proceed as follows:
  - The first screen you see is the “START?” screen. To confirm, press the “Light / OK” key. “LEFT” ap pears on the display screen.
  - Turn the controller to the left as far as it will go. To confirm, press the “Light / OK” key. “MIDDLE” appears on the display screen.
  - Turn the controller to the middle (zero position) and confirm by pressing the “Light / OK” key. “RIGHT” appears on the display screen.
  - Turn the controller to the right as far as it will go. Once you have confirmed by pressing the “Light / OK” key, you return to the start level “RESET”.



#### 3.6. “STOP-MODE”

In the event of an emergency, press the “STOP” key during drive mode to trigger an immediate emergency stop. You determine the exact effect of the emergency stop in menu item “STOP MODE”.

- 3.6.1. “DISABLE VOLTAGE”: The entire system is disconnected from the voltage supply;
- 3.6.2. “EMERGENCY STOP”: All locomotives stop immediately but the voltage supply remains in place. You can still trigger a “selective emergency stop” which only affects the selected locomotive in spite of this setting. See page 40.

**Factory setting:** DISABLE VOLTAGE

- To confirm, press the “Light / OK” key. You return to the start level “STOP MODE”.



#### 3.7. “INFOS”

A menu item which provides you with information on the software version (“SOFTWARE”), the type of X-Bus (“X-BUS”) and the current master (“COMMAND STATION”) in a digital system.

You call up the desired information using one of the “arrow keys”. You return to the start level by pressing the “Light / OK” key.

## Section 3 ■ Appendix

### multiMAUS Compatibility – all useable devices

#### 1. Previous Lokmaus systems

All ROCO digital devices which are based on X-Bus technology can be combined with the **multiMAUS**. These include:

- Lokmaus 2 / PowerMouse / Lokmaus R3: 10760 / 10790 / 10860 / 10792,
- amplifiers 10761 and 10764,
- boosters 10762 and 10765,
- interface 10785,
- transformers 10718 and 10725,
- ROCO feeder tracks 42517 (RocoLine), 61190 (Roco **geoLINE**),

and all ROCO add-on devices.

The ROCO Lokmaus Digital-is-Cool system – 1 10750 and central control unit 10751 – can be used with the **multiMAUS** without restriction to all its functions. All you need is the 10759 translation device which is connected directly (or via the 10758 distributor) to the “Slave” socket of the booster. You can then use the Lokmaus 1 to control addresses 1–8 and the light plus one other additional function. The digital cranes can also still be controlled by the Lokmaus 1. All decoders must be set to “14 speed steps” because the Lokmaus 1 can only control this mode.

#### 2. Add-on devices and decoders

The **multiMAUS** is compatible with X-Bus systems e.g. the Lenz Digital Plus System (X-Bus and XpressNet) and the HKE digital system. For more detailed information on connecting the **multiMAUS** to these systems, contact the respective manufacturer or consult a specialist or local dealer.

On a system controlled by the **multiMAUS**, you can use not only locomotives with ROCO locomotive decoders but also vehicles with decoders from other manufacturers, as long as they are in line with the NMRA / DCC standards.

Even locomotives made by other manufacturers can be equipped with ROCO decoders if the necessary room for installation is available. See the operating manual for the respective decoder.

### Using Locomotives without a Digital decoder and multiMAUS

Do not use locomotives without a decoder with the **multiMAUS**. The locomotive has a completely different voltage supply and would cause very disruptive, high frequency noise. There is also a danger that the motors would become damaged.



It is imperative that you do not connect a normal transformer on the same circuit parallel to the digital controller. This could destroy the digital booster!

You can also equip existing locomotives with a locomotive decoder. This is a quick and easy process when using ROCO locomotives with a digital interface because the decoder simply has to be plugged into a socket inside the locomotive. You do not need to perform any mechanical work on these locomotives because the space for the decoder is already provided. Instructions on how to install a decoder are also included in the manuals for these locomotives.

Even locomotives made by other manufacturers can be equipped with ROCO decoders if the necessary room for installation is available. If they are equipped with a digital interface the conversion is just as easy as with a ROCO locomotive. If you wish to install the 10745 load-controlled locomotive decoder, the locomotive will require a direct current motor or the existing all-current motor will need to be converted to direct current before installation.



## The master-and-slave principle

GB

If a **multiMAUS** is plugged into the master connection on the amplifier, it automatically becomes the master. This **multiMAUS** is then the higher order instance – the central control unit – in the digital system. In order to be able to use all functions without restrictions, you should only connect one **multiMAUS** to this connection on the amplifier. A Lokmaus 2 used as a master severely limits the options for a **multiMAUS** used as a slave.

Only one device at a time can be connected to the master connection of the amplifier!

All the Lokmaus devices connected to the slave socket on the amplifier or any other devices automatically have the status of slave. If the master Lokmaus is removed, an immediate emergency stop is triggered.

If a locomotive is already controlled by another mouse connected to the system, the locomotive symbol flashes. The locomotive can still be taken over by another mouse at any time if either a function is selected or the controller is activated. However, the speed and direction of travel of the locomotive remain unchanged until the controller on the mouse taking over the control is activated. The functions activated in the locomotive are displayed by all mice.

## Combination of digital and non-digital system parts

All ROCO digital locomotives can be driven on both digital and “normal” direct current systems without any complications. The locomotive decoder automatically detects the type of system it is on. It is therefore simple to use both types of systems together so that you can still use non-digital locomotives on the direct current section of the system.

### Separator module 10768

The digital and analogue sections of your systems need to be insulated on both sides at the change-over turnout so that there is no electrical connection between the two systems. For this purpose you can use either the insulating track connectors 42611, 61192 or saw the track profiles.

The wheels of the vehicles would however still cause a short circuit between the digital and normal current which could in turn destroy the booster. To prevent this, install the separator module in the supply line of the normal drive transformer to the feeder track. It immediately breaks the connection between the normal transformer and the feeder track when the separating point between the systems is jumped. Thus the short circuit detection does not switch off the **multiMAUS** and the train can pass the separating point.

At the change-over from digital to direct current operation the locomotive decoder immediately detects the operating mode and sets the speed of the locomotive to the respective voltage. The decoder also checks the polarity of the direct current during the change-over. If it does not match the direction of travel, the train stops with the programmed braking delay. If the train is to travel on further, you must first set the transformer controller to zero and start the train again.

The decoder acts in the same way when making the change-over in the opposite direction. It retrieves the digital information in the digital circuit immediately and continues to travel accordingly. The locomotive decoder also checks the direction of travel in this case and stops the train with the programmed braking delay if it does not match the actual direction of the current. You now have to change the direction of the train with the **multiMAUS** in order for it to travel any further.

### A change-over section of track

The simple switching method using the 10768 separator module described above has one minor disadvantage if there are several trains in the conventional section of the system:

The entire conventional area is supplied with digital current when the train jumps the separating point. This causes all normal locomotives to stop and all digital locomotives to retrieve their digital information and behave accordingly at that moment.

You can prevent this unwanted effect using a change-over section of track ( see fig. 4 on page 63). It needs to be as long as the longest train. It is double-pole insulated on both sides. The change-over section of track is now monitored and changed accordingly by the separator module when the train passes over the separating point. Drive operation on the rest of the system remains unaffected.

## The 10765 Booster

You require a booster if the system often switches off without the occurrence of a short circuit, i.e. no locomotive or carriages have derailed and there are no faults in the wiring. In this case, there is an overload due to too many consumers (locomotives, illuminated carriages etc.). The booster connects an additional transformer (ROCO 10725 or 10718), provides more energy and thus clears the overload.

 Two boosters must not be connected to the same transformer! Each of these devices requires its own voltage supply.

### Connecting one or more boosters 10765

Divide up the system into separate supply sections so that the number of consumers in each supply section is as evenly distributed as possible. You calculate the power consumption in a section as follows:

- Stationary locomotives with light, approximately 100 mA
- Travelling locomotives from approximately 300 to 600 mA depending on size and load
- Illuminated carriages, approximately 30 mA depending on the bulb
- Digital coupling or smoke generator, approximately 100 mA

If the power consumption exceeds 2.5 A, the section will be overloaded and will need to be divided up. You must also make sure there are large tolerances in the current consumption, especially for light bulbs. Use the 42624 digital turnout drive or connect another turnout decoder directly to the drive circuit. You will then have to calculate approximately 500 mA reserve for the switching current of the turnout.

If you have ensured that the system has a sufficient supply of power, the division of the booster sections is of no significance to the reliability of commands, for drive operation or for switching turnouts.

Switch off the system before installing a booster. Divide the system into supply sections. Disconnect the tracks electrically from each other in the respective places (on both sides!) wether using ROCO insulating rail connectors 42611 or 61192, insulated track or by sawing the rail profiles. Install a section of power track (e.g. 61190) in the new supply section and connect it to the "Track Out" socket on the booster. Connect the booster to its transformer. Then connect 10765 booster to amplifier 10764 with the special cable included in the box by plugging it into the socket marked "Booster Out" on amplifier 10764 and the socket marked "Booster In" on booster 10765. Fig. 3 on page 62 shows the complete wiring.

If required, you can connect further boosters to the "Booster Out" socket of the 10765 booster. A maximum of four 10765 boosters can be connected to the 10764 amplifier.

However, for large systems more than four 10765 boosters can be connected in conjunction with a 10779 braking generator. The 10764 amplifier, 10765 booster and braking generator have to be connected in the following sequence: 10764 (or 10761) – 3 x 10765 – 10779 – 3 x 10765 – 10779 etc.

 Make sure that the tracks have the same polarity at the change-over turnout so that short circuits are not caused when a train passes over the separating turnout. If a short circuit occurs, turn the power track plug 180°.

It is imperative that you make sure that the power track does not contain any capacitors.

## Terminal Loops in Digital Operation

GB

Every model railway enthusiast knows the problem of terminal loops from his / her conventional system. In digital operation too, the left-hand rail profile meets the right-hand rail profile after a terminal loop and would cause a short circuit without the appropriate wiring.

The ROCO 10769 terminal loop module solves the problems of a terminal loop in digital operation. Isolate the terminal loop with both poles on both sides by disconnecting the terminal loop completely from the rest of the system, using either insulated connectors or by sawing the rail profiles (see fig. 5 on page 64). It is imperative that the isolated section of track within the terminal loop is longer than the longest train which is going to travel through the terminal loop. The power supply to the terminal loop is connected to the output of the terminal loop module which provides the power supply for the terminal loop. The module itself is connected either to a track outside the terminal loop or directly to the amplifier.

The terminal loop module functions as follows: A train enters the terminal loop – the direction is not important – and the polarity of the tracks before and within the terminal loop is not identical. There is then a short circuit within the module which the module immediately detects. The module then reverses the polarity in the terminal loop before the short circuit detection function of the amplifier detects anything or the train slows down. The terminal loop polarity is then corrected for the entry of the train. The reverse of polarity in the terminal loop does of course render the polarity incorrect for the train's exit from the loop. This procedure or reversing the polarity is therefore repeated when the train exits. Since in digital operation the polarity of the tracks do not determine the direction of travel of the train; the train can pass through the terminal loop without stopping or without your intervention.

In order for the terminal module to detect incorrect polarity in time, you have to set its sensitivity using the potentiometer visible on the side. See the terminal loop module's instructions for use.

## Glossary

### → Decoder

In order to make the digital control signals of the **multiMAUS** understandable to “conventional” technology, you require a “translator” – the decoder. It does not replace any of the components in the analogue direct current locomotive but is a necessary addition and must also be given a place in the locomotive housing. For alternating current locomotives on the other hand, the change-over module or relay is replaced by the decoder, not in DCC format but of course Motorola format.

### → CVs

All values which affect the behaviour of the locomotive decoder – and ultimately the behaviour of the locomotive – are stored in what are referred to as CVs. CV is the abbreviation for configuration variables. The **multiMAUS** is compatible with the NMRA / DCC standard and can therefore read and write these variables.

 ROCO amplifiers 10761 and 10764 and booster 10762 and 10765 cannot be used to read the CVs from a decoder! The values shown are only fictitious suggested values.

CVs range from “0” to “255”. This shows that reprogramming requires experience, as incorrectly set CVs may have an adverse effect on the performance of the decoder.

### → Speed steps

On a conventional model railway a regulating transformer is used to control locomotives. The transformer emits voltage values to control the locomotive motor between 0 volts and the maximum voltage (typically between 12 and 16 volts) via the controller.

In a digital system on the other hand, the track always carries a fixed constant voltage. The motor is controlled

by the control signals which the decoder converts into voltage values. These signals are made up of “zeros” and “ones” and are therefore modified. The smaller the steps – speed steps – are, the more accurately the locomotive can be controlled. The DCC / NMRA standard, according to which the **multiMAUS** works, recognises 14, 27, 28 or 128 speed steps.

Modern decoders (from about 2000 onwards) can be controlled using at least 28 speed steps. They automatically set to the number of speed steps set in the locomotive controller (i.e. the **multiMAUS**) so that you do not need to make the setting in the decoder yourself. See the respective operating manual to determine whether your decoder is compatible with automatic speed step setting and which speed steps your decoder accepts.

→ **Smart-Search function**

The **multiMAUS** has a **smart search function**, which provides assistance when searching for an locomotive. The function is available in both library mode and locomotive address mode.

Each locomotive address which you call up while using the system is entered into the internal smart search list. If you search for a locomotive by pressing one of the arrow keys, the search procedure briefly stops on each locomotive in the list. This way, you can find the locomotives you have used very quickly.

A maximum of 32 locomotives can be included in the list of smart search addresses. The list is of no benefit for a single locomotive. If you have called up more locomotives than what fits in the list, the oldest locomotive is deleted from the list. You delete all smart search addresses by restarting the system (disconnect power supply or unplug the master **multiMAUS**).

You activate the smart search function using the menu item “USERINTERFACE” (see page 51, 3.2.5).

→ **Amplifiers and Boosters**

They supply the model railway system with the necessary voltage and conduct the digital control signals from the **multiMAUS** to the locomotives, turnouts and other digital accessories.

→ **X-BUS**

The **X-Bus** is the connection between the digital components (**multiMAUS**, booster, interface etc.) and not only supplies voltage but is also responsible for data exchange.

The master mouse always has a fixed address, other devices search automatically for free addresses so that you normally do not need to make any changes.

## Hints, Tips and Help

<p>Library or locomotive address mode: Selected locomotive does not react</p>	<ul style="list-style-type: none"> <li>▪ Does the locomotive address in the library match the address in the locomotive decoder?</li> <li>▪ Has an emergency stop or selective emergency stop been triggered?</li> <li>▪ Select an address in locomotive address mode.</li> </ul>
<p>The Turnout reacts incorrectly or the turnout setting does not match display</p>	<ul style="list-style-type: none"> <li>▪ Turn the plug on the turnout drive.</li> </ul>
<p>POM mode: Programming is confirmed, but the decoder does not react to an altered value</p>	<ul style="list-style-type: none"> <li>▪ Decoder needs to be reset: Switch the track voltage off and back on again using the “STOP“ key (emergency stop). See the operating manual for the decoder.</li> </ul>





























<p>The <b>multiMAUS</b> cannot be reset (3.5., page 52)</p>	<ul style="list-style-type: none"> <li>▪ In this case, it helps to pull the plug and press the shift key together with the “MENU” key when plugging the cable back in.</li> <li>▪ The <b>multiMAUS</b> is reset completely to the factory settings. Since this deletes the locomotive library, you should make sure you are certain you wish to take this step.</li> </ul>
<p>Scrolling in locomotive address mode is slow or not possible at all</p>	<ul style="list-style-type: none"> <li>▪ There is a problem with the X-Bus. Switch the system off and back on again. Check whether menu item 3.3.2. is set to “automatic”. It is possible that two devices have the same X-Bus address.</li> </ul>



## Programming Help for Lokmaus 2 / R3 – multiMAUS

Previous operating manuals for digital ROCO articles (e.g. 42624 turnout drive) only describe the standard programming mode for Lokmaus 2 / R3. The following includes a table which compares the programming procedure for the Lokmaus 2 / R3 and quick programming (see page 42) on the **multiMAUS**.

For more information see the operating manual for the Lokmaus 2 / R3. To program CV29 see the operating instructions included with the decoder.

CV	multiMAUS	Lokmaus 2 / R3 (for comparison)
1 – Address	 + 	 + 
2 – Minimum speed	 + 	 + 
3 – Start-up delay	 + 	 + 
4 – Braking delay	 + 	 + 
5 – Maximum speed	 + 	 + 
29 – Decoder settings	Can only be programmed in menu mode (see page 49)	 + 
Change speed steps	 +  / 	 +  / 



The ROCO electrics handbook, article number 82071, which is available as a CD-ROM from your local dealer, includes many tips and much information on the subject of model railway electrics and digital technology.

The ROCOMOTION system controller also has numerous options which can also be used in conjunction with the **multiMAUS**. For information on the ROCOMOTION consult your local dealer or visit [www.roco.cc](http://www.roco.cc).

## Error Messages

- ERR 1: Not compatible for programming.
- ERR 2: No confirmation was received from the decoder when programming / reading.  
Check whether the connection to the decoder is faulty due to dirt on the tracks or wheel contacts. Replace the locomotive on the track.  
Check whether there is a capacitor somewhere in the track system.
- ERR 3: A short circuit has occurred whilst programming / reading.  
Check whether the locomotive is placed correctly on the track and make sure the wiring is not faulty.  
The locomotive may be standing on a polarized frog (the turnout setting however does not match the route of the locomotive).  
The decoder may not be connected properly on a converted locomotive.
- ERR 4: Not possible in "POM" mode.  
This error occurs if the **multiMAUS** is changed over to "POM" mode (page 49) when you are intending to program CV1 (locomotive address). Program CV1 on a separate section of programming track in "CV mode" (see page 49).
- ERR 5: Programming mode is active.
- ERR 6: Not available because track voltage is switched off (occurs in "POM" mode).
- ERR 7: The library is empty (menu "LOCO" – "DELETE").
- ERR 8: The library is full (e.g. when entering a new locomotive).  
You can save a maximum of 64 locomotives in the library. Control the locomotive using locomotive address mode or use an additional **multiMAUS**.
- ERR 9: The locomotive was not found (menu "LOCO" – "SEARCH").  
The locomotive address has not been created in the library.
- ERR 10: A locomotive with the same address already exists (when entering a new locomotive in the locomotive library).
- ERR 11: The locomotive address is outside the valid value range.  
You are using a Lokmaus 2, for instance, as the master and it only supports 99 locomotive addresses.
- ERR 12: X-PressNet is not compatible with X-Bus.  
Only X-PressNet versions 3.0 and above are compatible with the **multiMAUS**.
- ERR 13: No X-PressNet master was found.  
There is a problem with the device connected to the master output. Unplug the device and reconnect it. If this does not solve the problem, check the X-Bus address.
- ERR 14: The calibration values are invalid.  
The controller needs to be recalibrated. See page 52, 3.5.6.
- ERR 90 and above:  
Your **multiMAUS** is unfortunately in need of service by the ROCO service department.

Fig. 1

LC-Display

LC display

Écran

LC display

Pfeiltaste (links)

Arrow Key (left)

touche »flèche«

(à gauche)

Tasto freccia (sinistra)

Licht / OK-Taste

Light / OK Key

touche »feux / OK«

Tasto luce / OK

Funktionstasten

Function Keys

touches »fonctions«

Tasti funzionali

Shift-Taste

Shift Key

touche »majuscules«

Tasto shift



Stop-Taste

Stop Key

touche »Stop«

Tasto di arresto

Pfeiltaste (rechts)

Arrow key (right)

touche »flèche«

(à droite)

Tasto freccia (destra)

Fahrregler

control knob

bouton régulateur

Regolatore di marcia

Lok / Weichen-Taste

Loco / Turnout Key

touche »Locomotive /

aiguillages«

Tasto locomotiva /scambi

Menü-Taste

Menu Key

touche »Menu«

Tasto menu

Beachten Sie die Erläuterungen zum Display und zu den Tastenbelegungen ab Seite 5.

Please refer the explanations about the display and the key assignment from page 34.

Quant aux informations concernant l'écran et les différentes fonctions des touches voir page 68.

Fate riferimento alle spiegazioni sul display e sulla assegnazione dei tasti da pagina 100.

Fig. 2

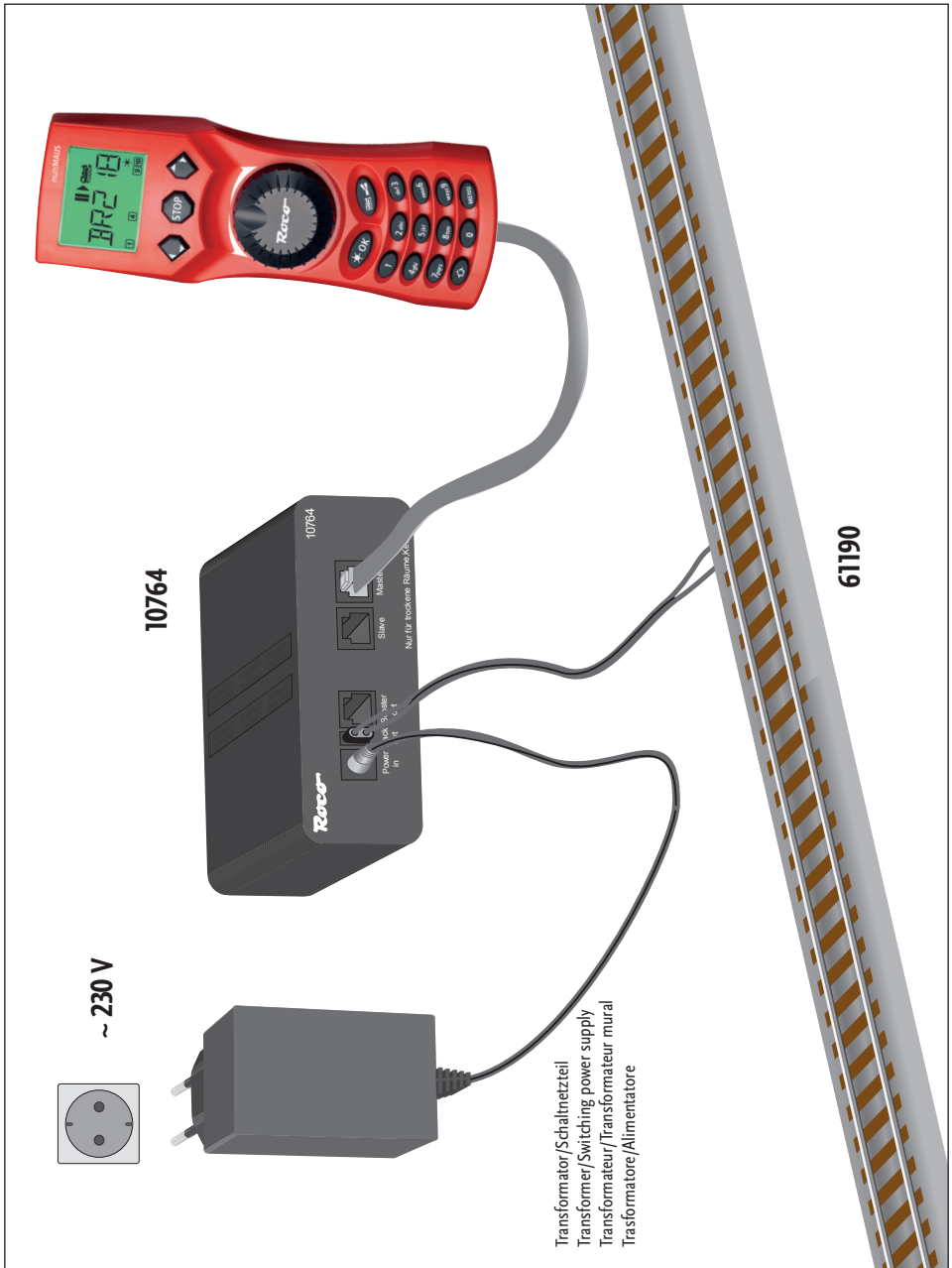

Aufbau des ROCO Digital-Systems (Europa-Version mit 230 V) mit der **multiMAUS**.  
 Setting up the ROCO digital system (Europe version with 230 V) with the **multiMAUS**.  
 Structure de la commande numérique ROCO (version européenne à 230 V) avec la **multiMAUS (=multiSOURIS)**.  
 Struttura del sistema digitale ROCO (versione europea a 230 V) con il **multiMAUS**.



Fig. 3

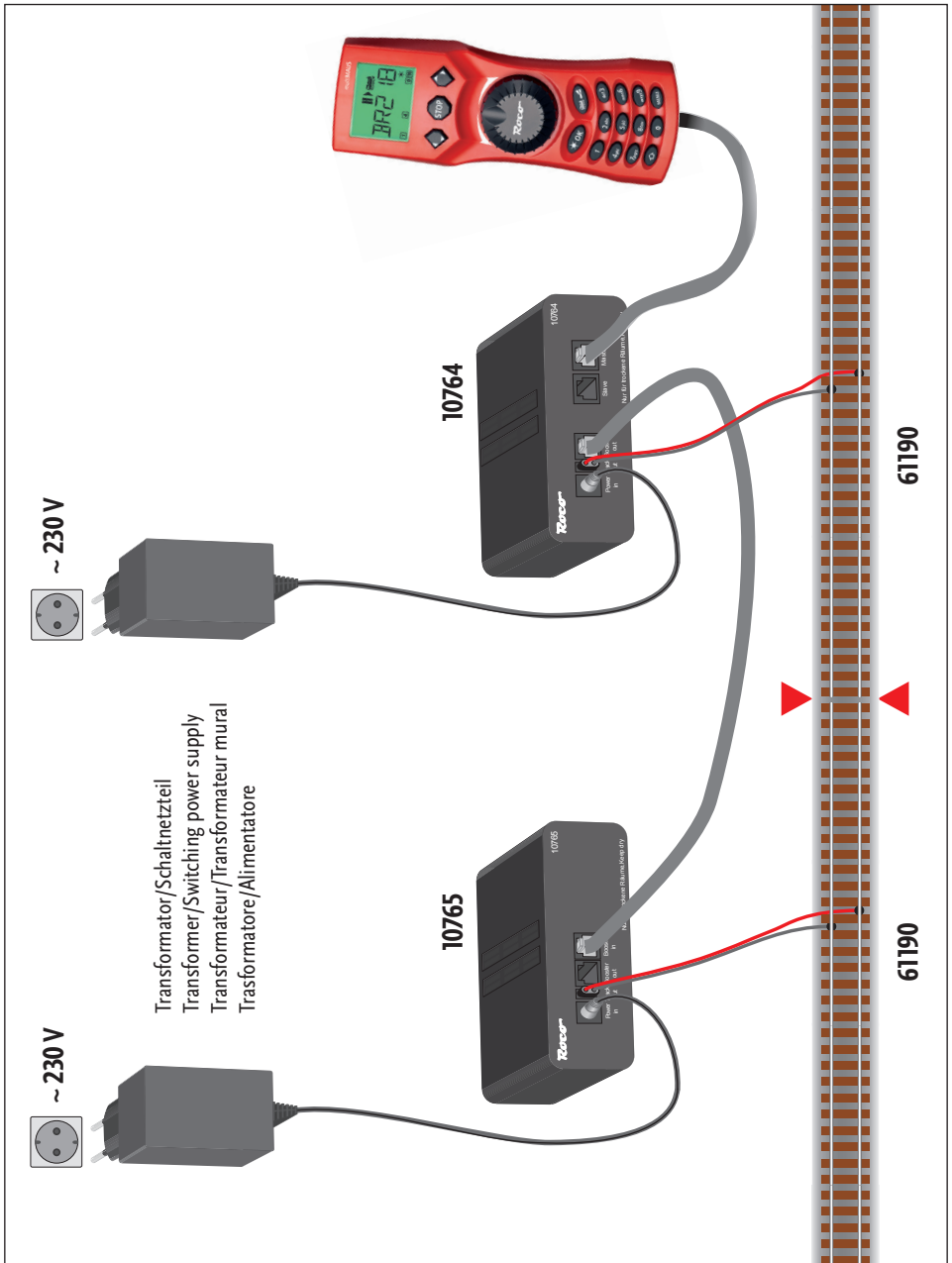

Anschluss eines Boosters 10765 an den Verstärker 10764 und die Gleisanlage.

Wiring diagram of the amplifier 10764, the booster 10765 and the tracks.

Comment câbler l'amplificateur complémentaire réf. 10765 avec l'amplificateur principal réf. 10764 et la voie.

Come collegare l'amplificatore 10764, il booster 10765 e i binari.

Fig. 4

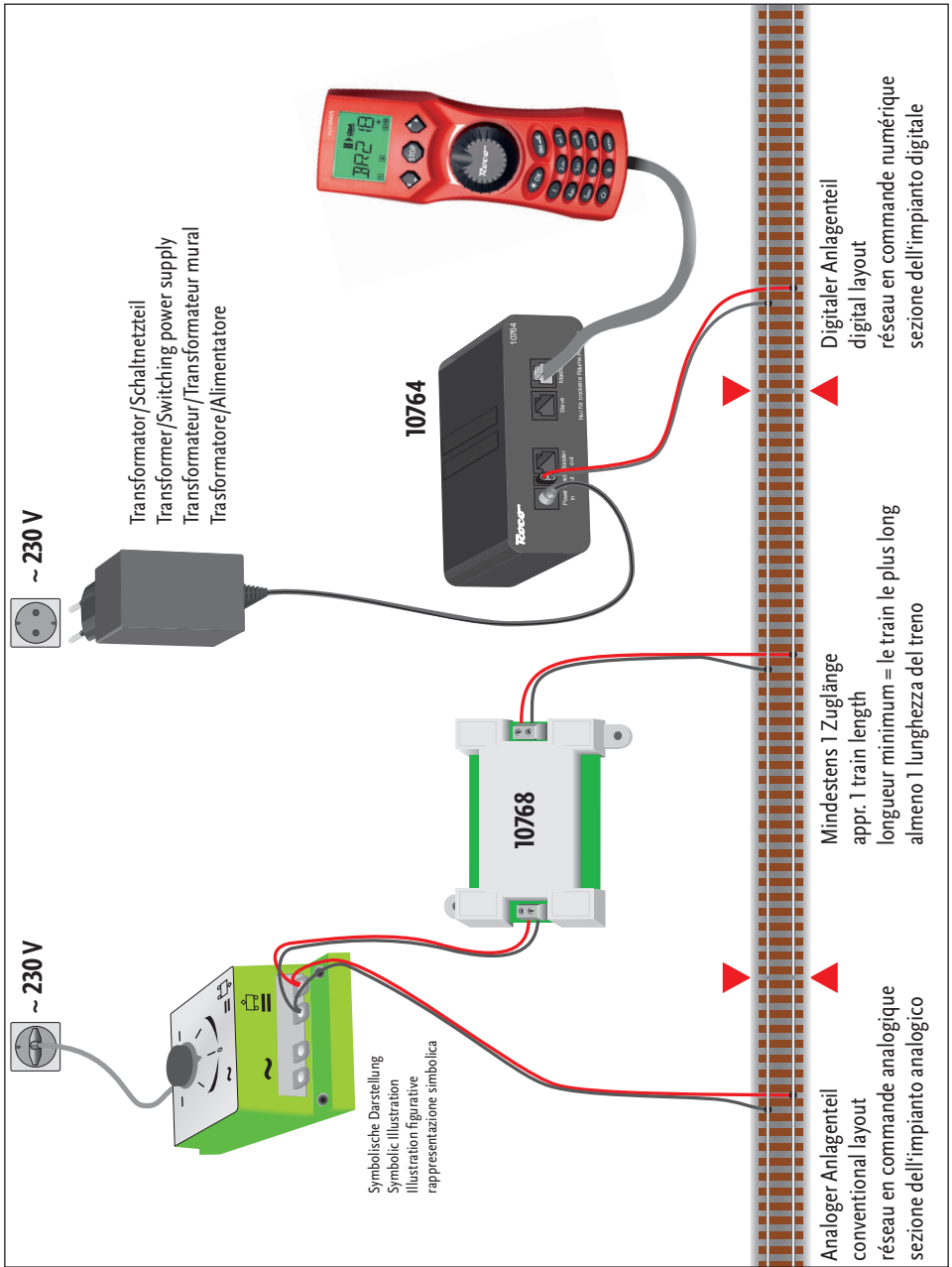

Übergangsstrecke Digital – Gleichstrom mit dem Trennmodul 10768.

Pass-over section with additional tracks from digital to DC-layout controlled by the Separator module 10768.

Canton de transition de la section en commande numérique à celle en commande analogique avec le module 10768.

Una sezione di passaggio dal sistema corrente continua al sistema digitale con il modulo 10768.

**Fig. 5**

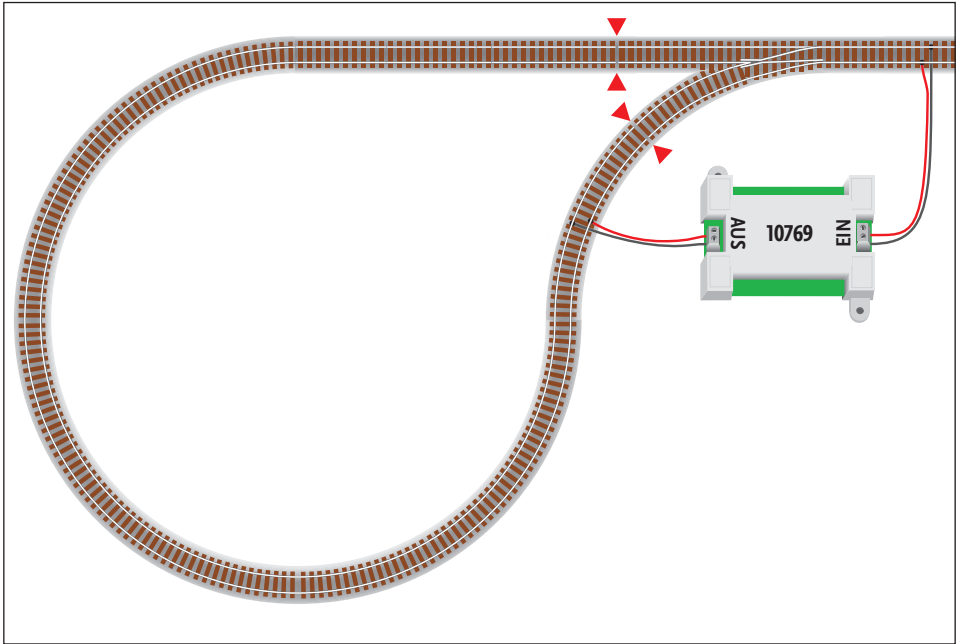

Eine digitale Kehrschleife mit dem Kehrschleifenmodul 10769.

A digital turning loop controlled by the modul 10769.

Branchement d'une boucle de retournement en commande numérique contrôlée par le module réf. 10769.

Una linea di raccordo digitale controllata per il modulo 10769.

**Hinweis / Note / À noter / Attenzione**

Symbol für Gleistrennung:

Sign for track insulation:

Symbole indiquant l'installation d'une éclisse isolante :

Simbolo per la diramazione dei binari:



## multiMAUS Kurzübersicht / Overview

### Fahren / Driving



= Lokauswahl  
Loco selection



= Nothalt  
Emerg. Stop



= Licht  
Light

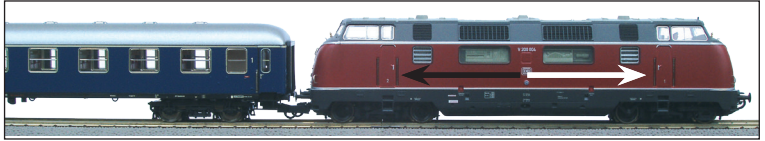

### Funktionen / Functions

(1) ... (0) = F1-F10

(↑) + (1) ... (0) = F11-F20

### Weichen / Turnouts

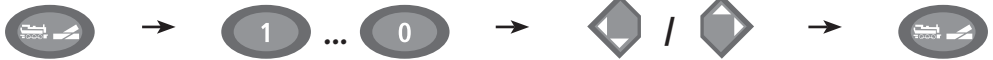

### Menüebene / Menu level

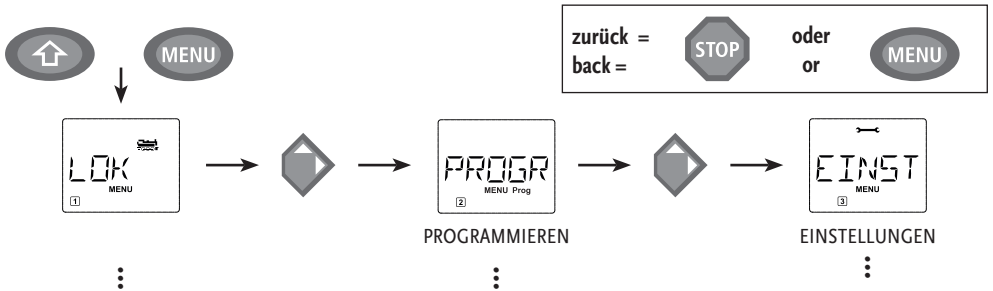

Änderungen von Konstruktion und Ausführung vorbehalten! ■ We reserve the right to change the construction and design! ■ Nous nous réservons le droit de modifier la construction et le dessin! ■ Ci riserviamo il diritto di variare la costruzione e il design! ■ Verandering van model en constructie voorbehouden.

Bitte diese Beschreibung zum späteren Gebrauch aufbewahren! ■ Please retain these instructions for further reference! ■ Pièze d'bien vouloir conserver ce mode d'emploi en vue d'une future utilisation! ■ Conservate queste istruzioni per un futuro utilizzo! ■ Deze handling altijd bewaren.

Modelleisenbahn GmbH • 5101 Bergheim • Austria



8010810920



VIII / 2011

