

# CONCORD TRANSFORMER X-BAG

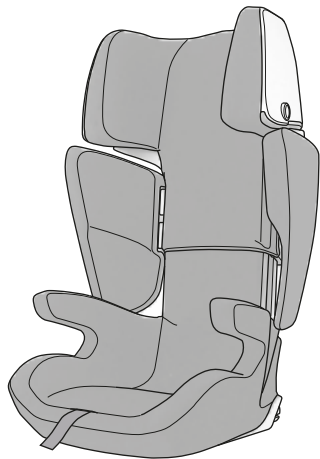

|            |     |
|------------|-----|
| DEUTSCH    | 03  |
| ENGLISH    | 25  |
| FRANÇAIS   | 47  |
| ESPAÑOL    | 69  |
| ITALIANO   | 91  |
| PORTUGUÊS  | 113 |
| NEDERLANDS | 135 |
| NORSK      | 157 |
| DANSK      | 179 |
| SUOMI      | 201 |

**Kindergewicht** 15 kg- 36 kg  
child's weight

**ca. Alter** 3-12 Jahre  
approx age

**ECE Gruppen** II und III  
ECE group

**Norm** ECE R44 04  
**standard** ECE R44 04  
**norme** ECE R44 04  
**norma** ECE R44 04  
**szabvány** ECE R44 04



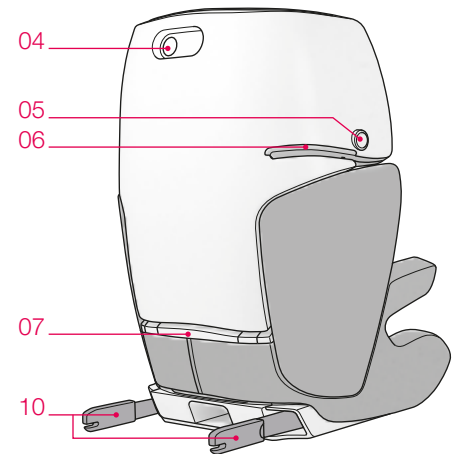
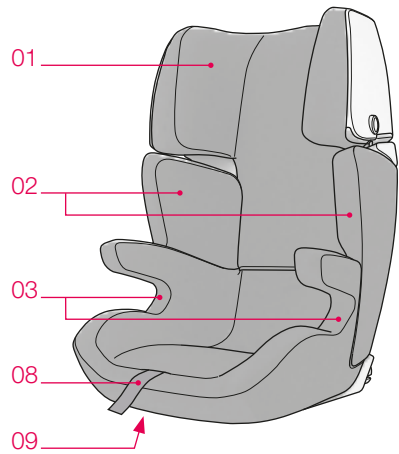

## \_ ENGLISH

|   |    |
|---|----|
| OVERVIEW  | 26 |
| THANK YOU!                                      | 28 |
| NOTES   | 28 |
| USING THE CONCORD TRANSFORMER                   | 32 |
| INSTALLING THE CONCORD TRANSFORMER              | 33 |
| INSTALLING THE CONCORD TRANSFORMER WITH TWINFIX | 34 |
| REMOVING THE CONCORD TRANSFORMER WITH TWINFIX   | 36 |
| VEHICLES SUITABLE FOR TWINFIX                   | 37 |
| SECURING THE CHILD WITH THE THREE-POINT BELT    | 38 |
| GENERAL INFORMATION                             | 41 |
| CARE INSTRUCTIONS                               | 42 |
| GUARANTEE                                       | 44 |
| CONCORD ORIGINAL SPARE PARTS/ACCESSORIES        | 46 |

## \_ OVERVIEW

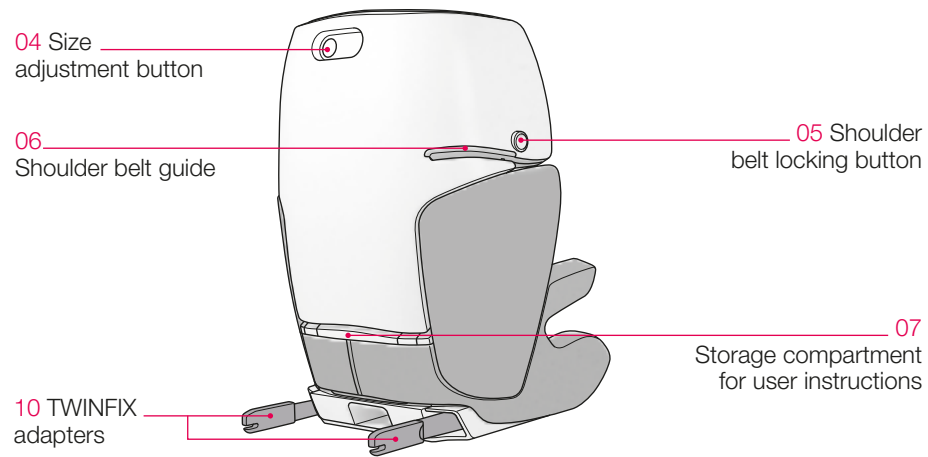
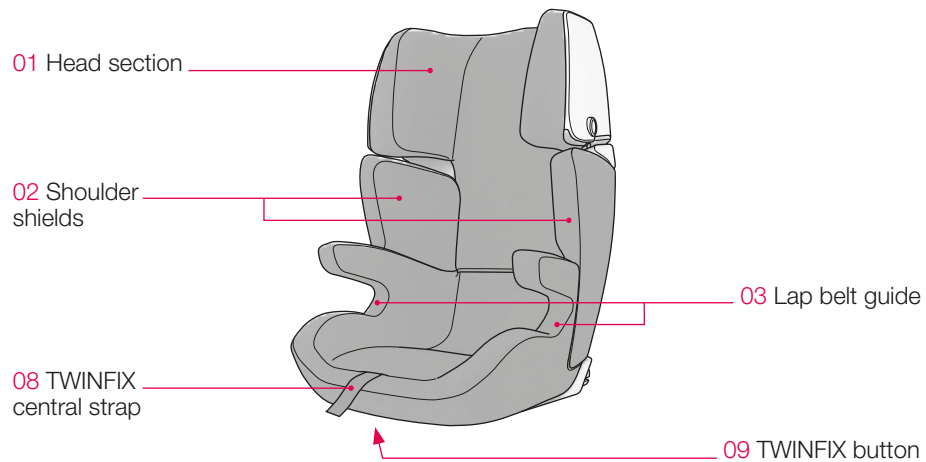

## **\_ THANK YOU!**

We are delighted that you have chosen a quality Concord product. You are sure to be convinced by this product's versatility and safety. We hope you enjoy using your new CONCORD TRANSFORMER.

## **\_ NOTES**

### **ATTENTION!**

- Please read the instructions for use thoroughly before using the CONCORD TRANSFORMER and keep them carefully for later reference. Not following the instructions described herein can put the safety of the child at risk! Please also note the instructions in the car's operating manual for transporting children in a car.

### **WARNING!**

- Do not leave your child unattended.
- Children sometimes have items in their jacket or trouser pockets (e.g. toy) or wear hard items that are attached to their clothes (e.g. belt buckle). Make sure that these items do not get between the child and the safety belt – they could cause unnecessary injuries in the event of an accident. These hazards also apply to adults!
- Naturally children can often be very lively. You should therefore explain to children how important it is to always be safely fastened in. Children must understand that they should never change the way the belts are positioned, and never open the buckle.
- Only if safety equipment is correctly installed and used can your child enjoy maximum safety.
- The system straps must be fitted tautly and without twists and must be protected against damage.
- Protect those parts of the CONCORD TRANSFORMER that are not covered in fabric from direct sunlight to avoid your child being burned.
- The child restraint system must not be damaged or trapped by moving parts in the car interior or by doors.
- Never modify the CONCORD TRANSFORMER in any way – this will endanger your child's safety.

- After an accident the CONCORD TRANSFORMER must be replaced or returned to the manufacturer for testing, along with a report of the accident.
- You should also tell your passenger how to remove the child in the event of an accident or danger.
- Do not leave your child in the child car seat unsupervised whether strapped in or not.
- Secure luggage and other items to reduce the risk of injury in the event of an accident.
- The user instructions must always accompany the child car seat.
- The use of accessories and replacement parts is not permissible and shall lead, in the event of contravention, to the expiry of all claims under the warranty and of all liability claims. Only special CONCORD original accessories are excluded.
- Suitable for cars with three-point (lap and diagonal) seat belts tested in accordance with ECE Regulation 16 or a comparable standard.

As the period of use for the CONCORD TRANSFORMER is very long, it is natural that seat covers and other used parts will each receive different degrees of wear and tear depending on the individual duration and intensity of use and will need to be replaced. For this reason it is not possible to give a blanket warranty of durability extending beyond a six-month warranty period. For additional purchases, please contact your local specialist child and baby shop, specialist departments in department stores, a car accessories centre or mail order companies. There you will also be able to buy the full range of accessories for CONCORD child car seats.

The buckle of the vehicle safety belt must not come above the edge of the lap belt guide. If in doubt or if you are still uncertain, please contact CONCORD. The belts may only be routed via the points of contact and the positions on the seat stated in the user instructions. Belts must not be routed in any other way.

If the car seat used has a front airbag, we recommend positioning the car seat as far back as possible. For cars with front and side airbags, the instructions in the car's operating manual must also be observed. The car's shoulder/diagonal belt must pass forwards from the vehicle bracket to the shoulder belt guide (06). Adjust the car seat position if necessary.

## \_ USING THE CONCORD TRANSFORMER

You have decided to purchase our CONCORD TRANSFORMER seat for the safety of your child. This product is manufactured under strict quality controls. It can only effectuate its maximum safety properties if it is used properly. The cover is an important component and contributes to the seat's effectiveness; for this reason the seat must only be used with its original cover! You should therefore ensure that you follow the instructions for fitting and use carefully.

The seat may be used on any seat in your car that is fitted with a three-point seat belt. Statistics suggest that the place behind the passenger seat is the safest in the car.

## \_ INSTALLING THE CONCORD TRANSFORMER

Place the CONCORD TRANSFORMER on the car seat or bench seat, facing in the direction of travel. The CONCORD TRANSFORMER should lie flush with the seat. In cars with standard headrests, these may be adjusted or removed to make it easier to install the child car seat.

Please note that the car headrests must be replaced and re-positioned correctly when an adult is travelling in the car.



The CONCORD TRANSFORMER must always be secured using the safety belt, also without a child. Otherwise passengers risk injury during the journey or in the event of an accident.

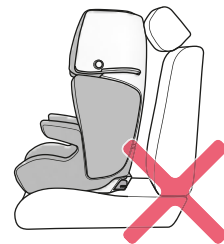

## \_ INSTALLING THE CONCORD TRANSFORMER WITH TWINFIX

Push the TWINFIX button (09) down and simultaneously pull out the TWINFIX adapters (10) on the back of the child seat to their full extent.

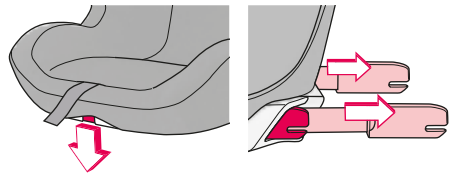

Position the CONCORD TRANSFORMER facing forwards on the vehicle seat or bench fitted with ISOFIX points.

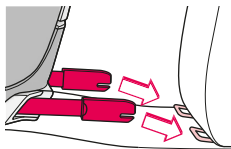

Push both TWINFIX adapters (10) on to the ISOFIX points in the vehicle until the locking mechanisms have clicked audibly into place.

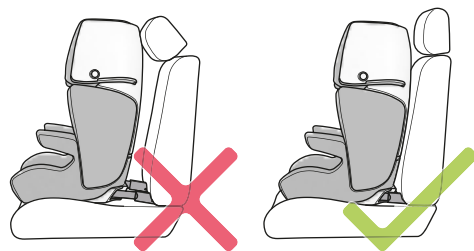
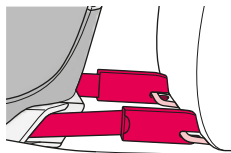

Pull the TWINFIX central strap (08) forwards and guide the CONCORD TRANSFORMER back until it lies as close/flush as possible to the car seat backrest.

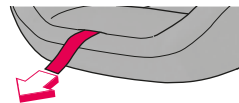

In cars with standard headrests, these may be adjusted or removed to make it easier to install the child car seat. Please note that the car headrests must be replaced and re-positioned correctly when an adult is travelling in the car.

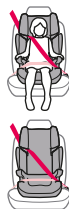

### **ATTENTION!**

- TWINFIX is an additional attachment system to stabilize the CONCORD TRANSFORMER and does not replace the security using the safety belt.
- Children and the seat without a child must always be secured using the vehicles own 3-point safety belt.



## \_ REMOVING THE CONCORD TRANSFORMER WITH TWINFIX

To remove the CONCORD TRANSFORMER, press the TWINFIX button (09) down and move the seat fully forwards.

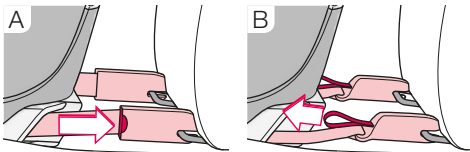

Now open the lock of the TWINFIX adapters (10) so that the safety hooks open and the adapters pop out.

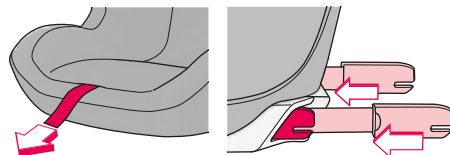

Pull the TWINFIX central strap (08) forwards until the TWINFIX adapters (10) are fully retracted!

You can also push the TWINFIX adapters (10) further into the seat by hand!

## \_ VEHICLES SUITABLE FOR TWINFIX

The CONCORD TRANSFORMER with CONCORD TWINFIX system has been certified for “semi-universal” use and is suitable for installation on the seats of specified vehicles.

Please refer to the additional “CAR FITTING LIST” leaflet for an overview of cars and vehicle seats compatible with the CONCORD TWINFIX system at the time your child seat was manufactured.

For a continuously updated version, please visit [www.concord.de](http://www.concord.de).

## \_ SECURING THE CHILD WITH THE THREE-POINT BELT

Seat your child well back in the seating area. Pass the three-point belt across the front of the child to the seat belt lock, and fasten it in the same way as for an adult. (There must be an audible click.)

Now position the belts. Pass the lap belt across both sides and the diagonal belt on the side of the seat belt lock through the lap belt guide (03).

Finally, pass the diagonal belt through the provided shoulder belt guide (06).

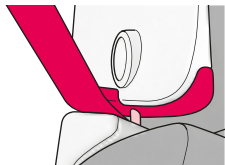

Make sure the belt passes inside the securing hook.

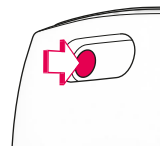

The CONCORD TRANSFORMER has 20 settings to adjust to the size of the child. Press the size adjustment control knob (04) at the rear of the CONCORD TRANSFORMER's backrest, and

move the head rest (01) into the correct position, while pressing and holding control knob (04). The CONCORD TRANSFORMER is arrested in place, when you release control knob (04).

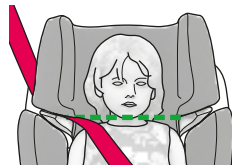
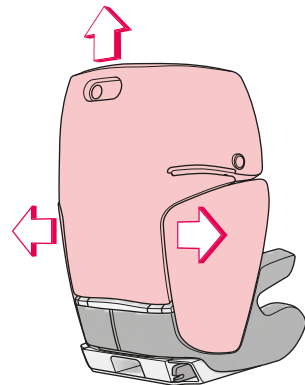

The shoulder belt guide (06) should be slightly above the top of the child's shoulder. At the same time, the shoulder belt should pass centrally between the child's neck and the outer edge of the shoulder.

Pull the belt taut so that the lap belt and diagonal belt are well positioned and ensure that the belts are not twisted. The lap belt should be in the lowest possible position. If your vehicle is fitted with a seat belt height adjuster, adjust its height accordingly.

When you wish to release the child from the seat, all you need to do is open the lock and pass the strap back across the child. To remove the shoulder belt from the guide, press the shoulder belt locking button (05) and pull the belt forwards and out.

It is important to ensure that the belts are always correctly positioned each time the seat is used. If in doubt about any aspect of fitting, check with CONCORD.

The belts must pass through the guides marked in red on the seat. Belts must not be routed in any other way.

## — GENERAL INFORMATION

- This is a “universal” child restraint system. It is approved for general use in vehicles in accordance with ECE Regulation 44, Amendment 04 and fits most, but not all, passenger vehicle seats.
- This child restraint system from ECE groups II and III is suitable for children from 3–12 years weighing 15–36 kg.
- It can be assumed that the system will fit correctly if the vehicle manufacturer states in the vehicle manual that the vehicle is suitable for the installation of a “universal” child restraint system for the relevant age group.
- This child restraint system has been classified as being of the “universal” class, satisfying stricter conditions than previous models which do not bear this label.
- If in doubt, please consult the manufacturer of the child restraint system or the retailer.
- Only suitable for vehicles with three-point (lap and diagonal) seat belts tested and approved in accordance with ECE Regulation 16 or a comparable standard.

## \_ CARE INSTRUCTIONS

The cover can be removed for washing. To do so, move the head section (01) to its highest position. To remove, pull the cover away from its anchoring points. Begin by removing the head section (01) followed by the seat section and the shoulder shields (02).

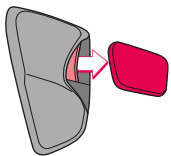

Remove the styrofoam parts from the covers in the shoulder area (02) before washing.

- When they come into contact with moisture, especially during washing, the cover fabrics may fade slightly.
- Do not use solvents!

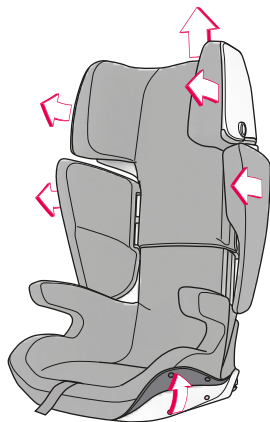

To replace, start with the cover for the seat section. Firstly, pull the cover over the cover panel on the backrest, and then, from the front, pull it over the armrests and seat section.

Secure the cover using all of the fastening points.

Attach the cover for the head section (01).

Place the matching styrofoam parts into the marked pocket on the inside of the covers for the shoulder area (02). Now pull the covers over the protectors for the shoulder area (02).

The covers and styrofoam parts must not be reversed!

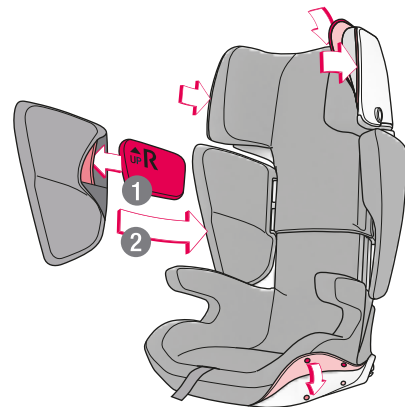

## **\_ GUARANTEE**

The guarantee begins on the day of purchase. The guarantee period corresponds to the statutory warranty period in the end-user's country concerned. At the manufacturer's discretion, the guarantee shall cover rectification, replacement or a price reduction.

The guarantee is valid for the original purchaser only. In the event of any defect, claims can not be considered unless the specialist dealer is notified of the fault as soon as it occurs for the first time. If the specialist dealer is unable to remedy the problem himself, he must return the product to the manufacturers together with details of the complaint, official proof of purchase and the purchase date. The manufacturers assume no liability for faulty goods that they did not supply.

The guarantee does not apply where:

- the product has been modified;
- the product is not brought back to the specialist dealer complete with proof of purchase within 14 days of the defect occurring;
- the defect was caused by improper usage or maintenance or due to anything else deemed to be the fault of the user, in particular failure to comply with the instructions for use;
- repairs have been carried out on the product by third parties;
- the defect was caused as the result of an accident.
- the serial number has been damaged or removed

The guarantee makes no provision for any alteration or deterioration to the product that is incurred through normal usage (wear and tear). The period of guarantee shall not be extended by any remedial measures carried out by the manufacturers in the event of a claim.

## **\_ CONCORD ORIGINAL SPARE PARTS/ACCESSORIES**

Information on Concord original spare parts/accessories is available at your retailer's or directly from Concord.

Concord GmbH  
Industriestraße 25  
95346 Stadtsteinach  
Germany

Phone +49 (0)9225.9550-0  
Fax +49 (0)9225.9550-55  
info@concord.de

[www.concord.de](http://www.concord.de)

\_ **DEUTSCH**

\_ **ENGLISH**

\_ **FRANÇAIS**

\_ **ESPAÑOL**

\_ **ITALIANO**

\_ **PORTUGUÊS**

\_ **NEDERLANDS**

\_ **NORSK**

\_ **DANSK**

\_ **SUOMI**

Einbau- und Bedienungsanleitung

Instructions for attachment and use

Directives d'installation et mode d'emploi

Instrucciones de montaje y de uso

Istruzioni per l'uso e il montaggio

Manual de montagem e de utilização

Inbouw- en bedieningshandleiding

Bruksanvisning og monteringsveiledning

Monterings- og betjeningsvejledning

Kiinnitys- ja käyttöohjeet

Concord GmbH // Industriestraße 25  
95346 Stadtsteinach // Germany

Phone +49 (0)9225.9550-0 // Fax +49 (0)9225.9550-55  
info@concord.de // www.concord.de

**TRXB 03/0415 . IM 1704 ,01**

