

- D** Die Verwendung des Zusatzgurtes ist nur beim Einbau des Sitzes in Fahrtrichtung und Verwendung des 3 Punkt Gurtes des Fahrzeuges notwendig.
- GB** The security strap is only required if you use the Varioguard Plus forward facing and the 3 point belt fixation of the car
- F** La bretelle de sécurité est seulement exigée si vous utilisez le Varioguard Plus en position face avant ainsi que les 3 points de fixation de la ceinture de la voiture
- E** El uso del cinturón adicional solo es necesario cuando monta la silla de auto en dirección marcha y asegura la silla con el cinturón de seguridad de 3-puntos de su vehículo.
- P** Eu uso o cinto adicional, so é necessário quando monta a cadeira do auto de bebe em direção de frente e amarra a cadeira com o proprio cinto de segurança do 3- pontos do suo carro.
- I** E' necessario usare la cintura di sicurezza aggiuntiva solamente quando il seggiolino Varioguard Plus è posizionato in senso di marcia e quando contemporaneamente viene utilizzata la cintura di sicurezza a tre punti dell'auto per bloccare la base.

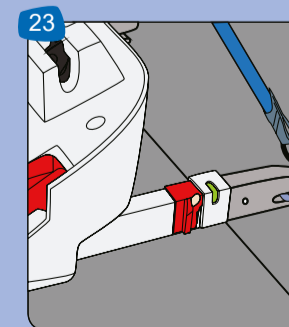

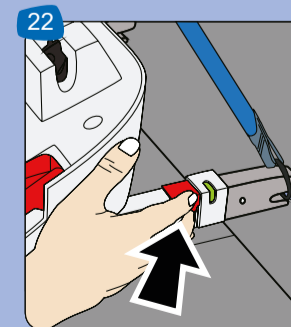

Isofix B1,C

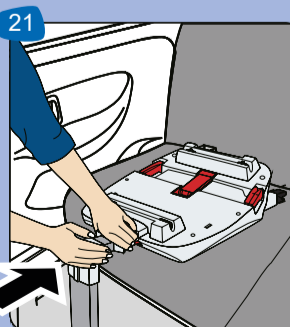
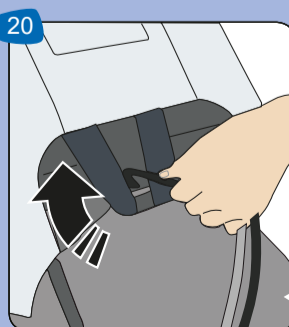
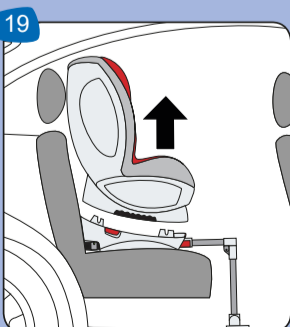
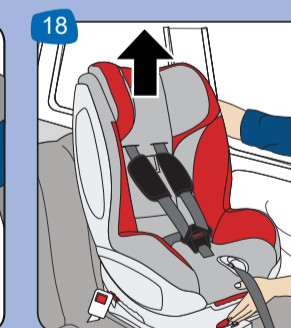
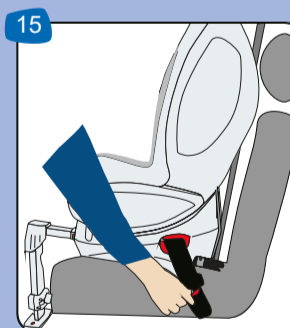
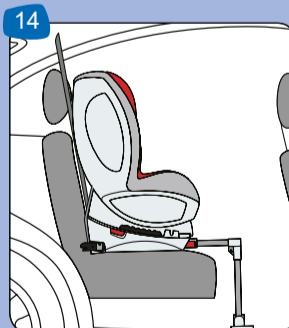
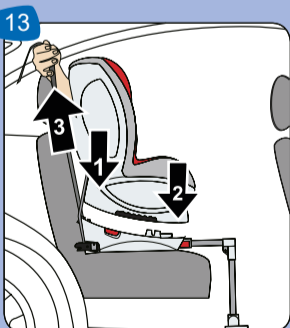
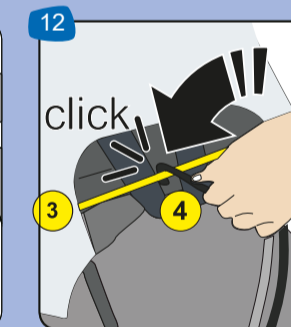
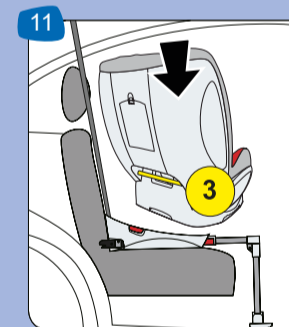
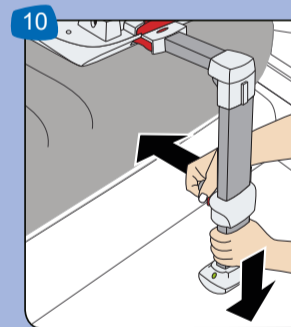
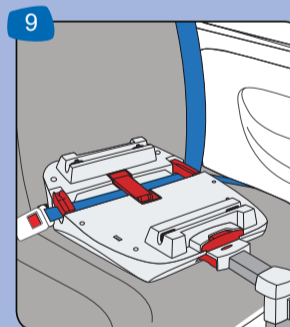
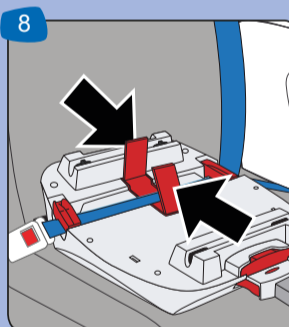
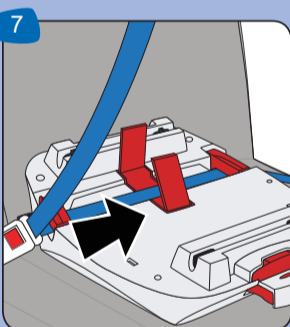
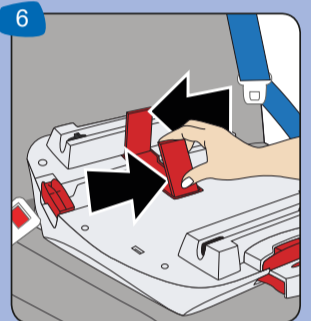
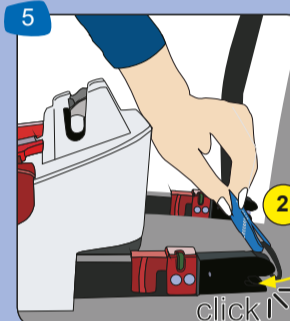
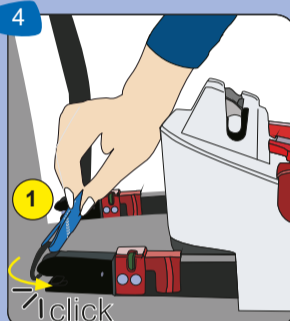
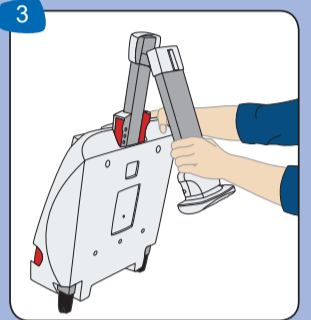
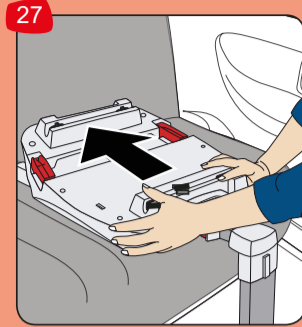
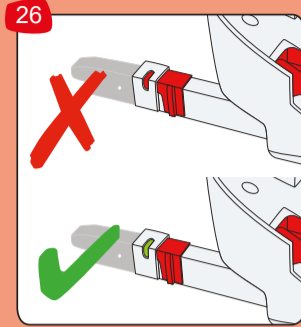
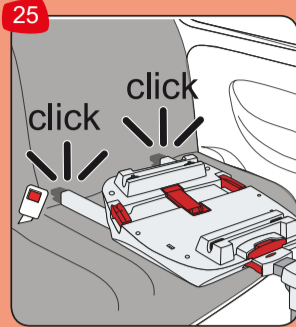
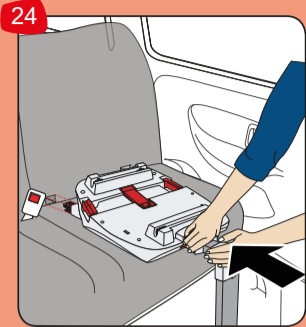

0 - 18 kg

Isofix

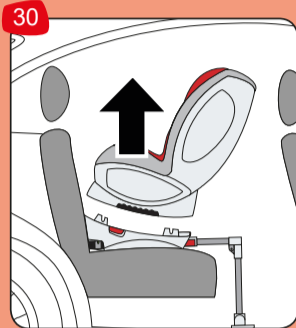
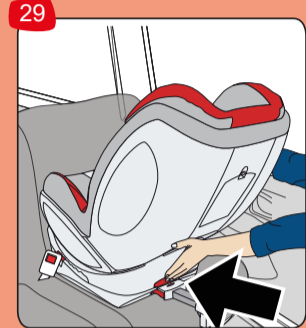
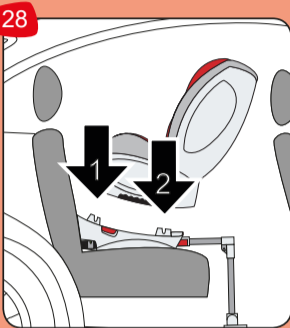

9 - 18 kg

Isofix

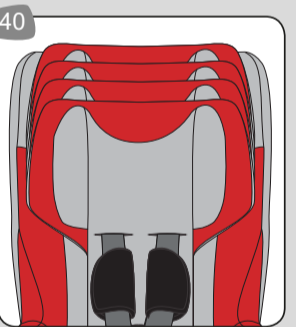
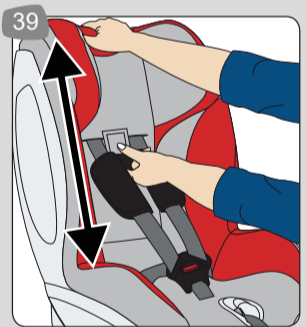
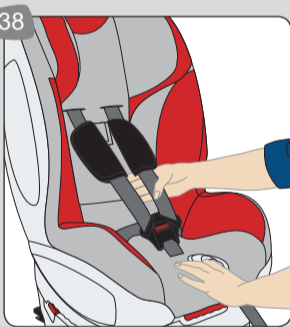
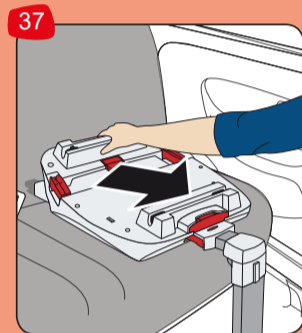
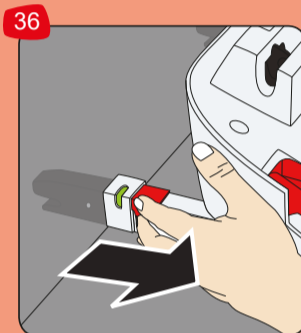
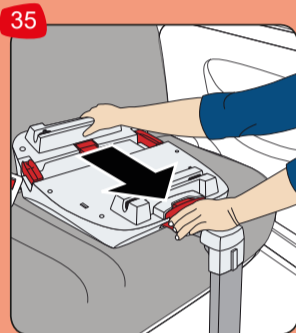
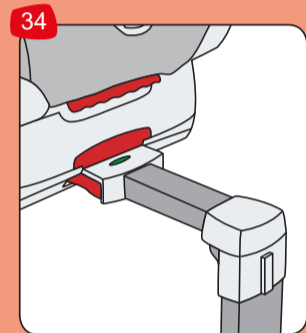
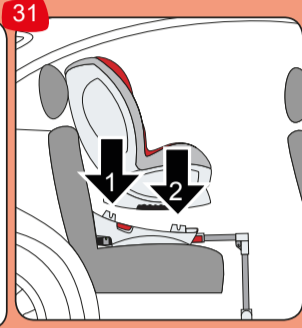

Einbau
Installation

[www.hauck.de/
varioguardplus](http://www.hauck.de/varioguardplus)



Varioguard Plus



hauck

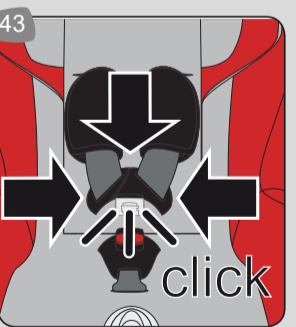
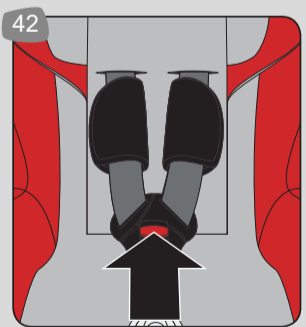
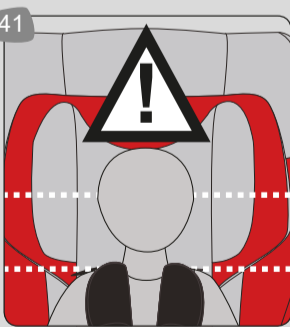

hauck GmbH + Co KG
Frohnlicher Str. 8
D-96242 Sonnefeld
Germany

Tel. : +49(0)9562/986-0
Fax : +49(0)9562/6272
E-mail : info@hauck.de
Internet: <http://www.hauck.de>