

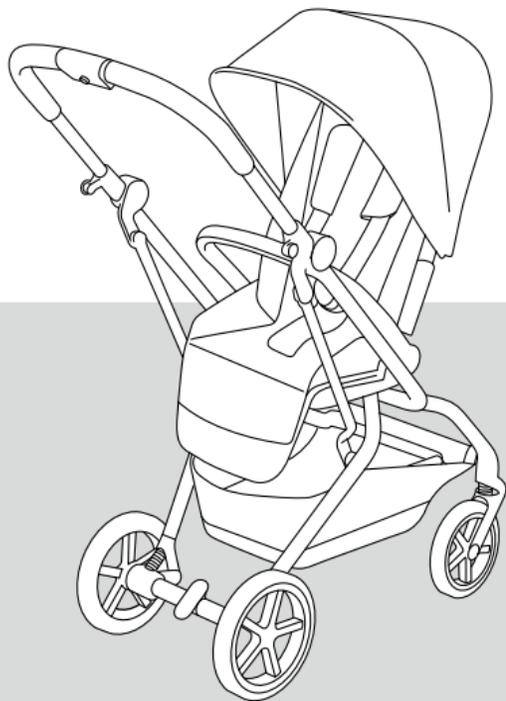

EEZY S TWIST²₊





EN WARNING
DE WARNUNG
ES ADVERTENCIA
FR AVERTISSEMENT
PT AVISOS
IT ATTENZIONE
NL WAARSCHUWING
PL OSTRZEŻENIE
CS UPOZORNĚNÍ
SK UPOZORNENIE
SL OPOZORILO
HR UPOZORENJE
HU FIGYELMEZTETÉS
SE VARNING
NO ADVARSEL
FI VAROITUS
DA ADVARSEL
ET HOIATUS
LV BRĪDINĀJUMS
LT PERSPĖJIMAS
RU ВНИМАНИЕ
UK УВАГА
TR UYARI
EL ΠΡΟΕΙΔΟΠΟΙΗΣΗ
RO AVERTISMENTE
IS VIÐVÖRUN
MT TWISSIJA

AR
FA
YUE 警告
CMN 警告
JA 警告
KO 경고
BG ПРЕДУПРЕЖДЕНИЕ
SR UPOZORENJE
MS AMARAN
HI चेतावनी
TH คำเตือน
SQ PARALAJMËRIM
BS UPOZORENJE
ME UPOZORENJE
MK ПРЕДУПРЕДУВАЊЕ
HY ՉԳՈՒՇԱՑՈՒՄ
VI CẢNH BÁO

تحذير
اخطار



EN Tutorial video
DE Videoanleitung
ES Tutorial en vídeo
FR Vidéo de démonstration
PT Video tutorial
IT Video tutorial
NL Instructievideo
PL Film instruktażowy
CS Výukové video
SK Výukové video
SL Video z navodili
HR Video s uputama
HU Bemutatóvideó
SE Videosjälvstudiekurs
NO Opplæringsvideo
FI Opetusvideo
DA Vejledende video
ET Õppevideo
LV Arpmācību video
LT Mokomasis vaizdo įrašas
RU Обучающее видео
UK Навчальне відео
TR Öğretici video
EL Εκπαιδευτικό βίντεο
RO Video tutorial
IS Kennslumyndband
MT Tutorial fuq vidjow

AR
FA
YUE 教程視頻
CMN 教程视频
JA チュートリアルビデオ
KO 튜토리얼 동영상
BG Учебно видео
SR Video sa uputstvima
MS Video tutorial
HI ट्यूटोरियल वीडियो
TH ตรีโอบเนนะน่า
SQ Video udhëzuese
BS Video sa uputstvima
ME Video sa uputstvima
MK Видеоупатство
HY Πλατύνειγνηλών εντελωνηνη
VI Video hướng dẫn

فيديو تعليمي
ويدئوى آموزشى



EN Maximum weights
DE Maximalgewichte
ES Pesos máximos
FR Poids maximum
PT Pesos máximos
IT Peso massimo
NL Maximumgewicht
PL Dopuszczalna waga
CS Maximální hmotnosti
SK Maximálne hmotnosti
SL Največje teže
HR Maksimalne težine
HU Maximális súlyok
SE Max.vikter
NO Maksimumsvektor
FI Enimmäispainot
DA Maksimumvægt
ET Maksimaalne kaal
LV Maksimālais svars
LT Didžiausi svoriai
RU Максимальная масса
UK Максимальна вага

TR Maksimum ağırlıklar
EL Μέγιστο βάρος
RO Greutăți maxime
IS Hámarksþyngd
MT Piżijiet massimi
AR الأوزان القصوى
FA حداکثر وزن
YUE 最大重量
CMN 最大重量
JA 最大重量
KO 최대 하중
BG Максимални тегла
SR Maksimalne težine
MS Berat maksimum
HI अधिकतम वजन
TH น้ำหนักสูงสุด
SQ Peshat maksimale
BS Maksimalne težine
ME Maksimalne težine
MK Максимални тежини
HY Առավելագույն քաշեր
VI Các mức cân nặng tối đa



EN Product registration
DE Produktregistrierung
ES Registro del producto
FR Enregistrement du produit
PT Registo do produto
IT Registrazione del prodotto
NL Productregistratie
PL Rejestracja produktu
CS Registrace výrobku
SK Registrácia výrobku
SL Registracija izdelka
HR Registracija proizvoda
HU Termékregisztráció
SE Produktregistrering
NO Produktregistrering
FI Tuotteen rekisteröinti
DA Produktregistrering
ET Toote registreerimine
LV Produkta reģistrācija
LT Gaminio registracija
RU Регистрация продукта
UK Реєстрація продукту

TR Ürün kaydı
EL Καταχώριση προϊόντος
RO Înregistrarea produsului
IS Skráning tækis
MT Reġistrazzjoni tal-prodott
AR تسجيل المنتج
FA ثبت محصول
YUE 產品註冊
CMN 产品注册
JA 製品の登録
KO 제품 등록
BG Регистрация на продукта
SR Registracija proizvoda
MS Pendaftaran produk
HI उत्पाद पंजीकरण
TH การลงทะเบียนผลิตภัณฑ์
SQ Regjistrimi i produktit
BS Registracija proizvoda
ME Registracija proizvoda
MK Регистрација на производ
HY Արձանագրություն
VI Đăng ký sản phẩm



= 16

EN	Set up	TR	Kurulum
DE	Aufbau	EL	Στήσιμο
ES	Instalación	RO	Setare
FR	Montage	IS	Uppsetning
PT	Preparação	MT	Konfigurazzjoni
IT	Configurazione	AR	تنصيب
NL	Opbouw	FA	برپا کردن
PL	Montaż	YUE	設置
CS	Nastavení	CMN	设置
SK	Nastavenie	JA	セットアップ
SL	Nastavitev	KO	설정
HR	Postavljanje	BG	Настройка
HU	Felszerelés	SR	Postavljanje
SE	Inställning	MS	Persediaan
NO	Oppsett	HI	सेट अप
FI	Asennus	TH	การติดตั้ง
DA	Opsætning	SQ	Konfigurimi
ET	Seadistamine	BS	Postavljanje
LV	Uzstādīšana	ME	Postavljanje
LT	Nuostatos	MK	Поставување
RU	Установка	HY	Շարժափոխում
UK	Встановлення	VI	Cài đặt



= 21

EN	Brake	TR	Fren
DE	Bremse	EL	Φρένα
ES	Freno	RO	Frână
FR	Frein	IS	Bremsa
PT	Bloqueio	MT	Brejġ
IT	Freno	AR	المكابح
NL	Rem	FA	ترمز
PL	Hamulec	YUE	剎車
CS	Brzda	CMN	刹车
SK	Brzda	JA	ブレーキ
SL	Zavora	KO	브레이크
HR	Kočnica	BG	Спирачка
HU	Fék	SR	Kočnica
SE	Broms	MS	Brek
NO	Brems	HI	ब्रेक
FI	Jarru	TH	เบรค
DA	Bremse	SQ	Frenat
ET	Pidur	BS	Kočnica
LV	Bremze	ME	Kočnica
LT	Stabdys	MK	Сопирачка
RU	Тормоза	HY	Արգելակ
UK	Гальма	VI	Phanh thắng



 = 22

EN	Folding	TR	Katlama
DE	Faltung	EL	Αναδίπλωση
ES	Plegado	RO	Pliere
FR	Pliant	IS	Brjóta saman
PT	Fecho	MT	Tiwi
IT	Ripiegamento	AR	
NL	Vouwen	FA	
PL	Składanie	YUE	折疊
CS	Skládání	CMN	折疊
SK	Zloženie	JA	折りたたみ
SL	Zlaganje	KO	접기
HR	Preklapanje	BG	Сгъване
HU	Összecsukás	SR	Preklapanje
SE	Ihopfällning	MS	Lipat
NO	Sammenlegging	HI	फोल्डिंग
FI	Kokoon taittaminen	TH	การพับ
DA	Sammenklapning	SQ	Palosja
ET	Kokkuvoltimine	BS	Preklapanje
LV	Salocīšana	ME	Preklapanje
LT	Lankstymas	MK	Склопување
RU	Складывание	HY	Ծախելը
UK	Складання	VI	Gập lại

قابلية للطي
تا کردن



 = 24

EN	Harness	TR	Emniyet kemeri
DE	Gurtsystem	EL	Συγκράτηση
ES	Arnés	RO	Centură
FR	Harnais	IS	Beisli
PT	Arnês	MT	Ċinga tas-sigurtà
IT	Imbracatura	AR	طقم الشد
NL	Harnas	FA	سیدستم مهار
PL	Szelki	YUE	安全帶
CS	Popruh	CMN	安全帶
SK	Popruh	JA	安全ベルト
SL	Varnostni pas	KO	하네스
HR	Sustav vezivanja	BG	Сбруя
HU	Biztonsági öv	SR	Sistem vezivanja
SE	Sele	MS	Abah-abah
NO	Beltesystem	HI	कबच
FI	Vyöjärjestelmä	TH	ระบบสายรัด
DA	Selesystem	SQ	Pajimet
ET	Turvarihmad	BS	Sistem vezivanja
LV	Drošības josta	ME	Sistem vezivanja
LT	Diržai	MK	Сигурносен каиш
RU	Ремни безопасности	HY	Ամրազուտի
UK	Ремінь	VI	Dây an toàn



 = 27

EN	Bumper bar	TR	Tampon çubuğu
DE	Schutzbügel	EL	Μπάρα διάταξης προστασίας
ES	Barra de seguridad	RO	Bară de protecție
FR	Barre de protection	IS	Þverbítí
PT	Barra de segurança	MT	Strixxa tal-bumper
IT	Barra paraurti	AR	عارضة ممتص الصدمات
NL	Veiligheidsbeugel	FA	میله ضربهگیر
PL	Pałak zabezpieczający	YUE	保險杠
CS	Dětské madlo	CMN	保險杠
SK	Detská rúčka	JA	バンパーバー
SL	Varnostni lok	KO	범퍼 바
HR	Štitnik	BG	Броня
HU	Karfa	SR	Štitnik
SE	Stötfångare	MS	Bar bumper
NO	Fender	HI	बम्पर बार
FI	Suojakaari	TH	แถบกันชน
DA	Sikkerhedsbøjle	SQ	Shufra e parakolpít
ET	Turvakaar	BS	Štitnik
LV	Aizsarglòks	ME	Štitnik
LT	Amortizatoriaus strypas	MK	Одбојник
RU	Поручень	HY	Թափարգել
UK	Обмежувальний поручень	VI	Thanh chống va đập



 = 28

EN	Seat direction	TR	Koltuk yönü
DE	Sitzrichtung	EL	Κατεύθυνση καθίσματος
ES	Dirección de la silla	RO	Direcție scaun
FR	Sens du siège	IS	Sætisstefna
PT	Orientação do assento	MT	Direzżjoni tas-sit
IT	Direzione di seduta	AR	اتجاه المقعد
NL	Zitrichting	FA	جهت صندلی
PL	Kierunek siedzenia	YUE	座椅方向
CS	Směr sedadla	CMN	座椅方向
SK	Smer sedadla	JA	シートの方向
SL	Smer sedeža	KO	좌석 방향
HR	Smjer sjedala	BG	Посока на седалката
HU	Úlésirány	SR	Smer sedišta
SE	Sitsriktning	MS	Arah kerusi
NO	Seteretning	HI	सीट दिशा
FI	Istumasuunta	TH	ทิศทางการที่นั่ง
DA	Sæderetning	SQ	Drejtimi i ndenjësës
ET	Istme suund	BS	Smjer sjedišta
LV	Sēdekļa virziens	ME	Smjer sjedišta
LT	Kėdutės kryptis	MK	Правец на седиште
RU	Направление сиденья	HY	Նստատեղի ուղղություն
UK	Напрямок сидіння	VI	Hướng ghế ngồi



EN	Removing and attaching the seat	TR	Koltuğun çıkarılması ve takılması	SE	Ta bort och montera sätet	MS	Mengeluarkan dan memasang tempat duduk
DE	Abnehmen und Anbringen des Sitzes	EL	Αφαίρεση και στερέωση του καθίσματος	NO	Slik fjerner og fester du setet	HI	सीट को लगाना और हटाना
ES	Extracción y colocación del asiento	RO	Scoaterea și atașarea scaunului	FI	Istuimen irrotus ja kiinnitys	TH	การถอดและติดตั้งคาร์ซีท
FR	Retirer et attacher le siège	IS	Að fjarlægja og festa sætið	DA	Aftagning og påsætning af sædet	SQ	Heqja dhe vendosja e ndenjësës
PT	Remoção e colocação do assento	MT	Kif tneħhi u twaħħal is-seat.	ET	Turvatooli eemaldamine ja kinnitamine	BS	Uklanjanje i pričvršćivanje sjedišta
IT	Rimozione e posizionamento del seggiolino	AR	فك المقعد وإعادة تثبيته	LV	Bērna sēdekļa atvienošana un uzstādīšana	ME	Uklanjanje i pričvršćivanje sjedišta
NL	De stoel verwijderen en bevestigen	FA	جدا کردن و وصل کردن صندلی	LT	Kaip įdėti ir išimti automobilinę vaiko kėdutę	MK	Отстранување и прицврстување на седиштето
PL	Wyjmowanie i mocowanie fotelika	YUE	拆除和安裝座椅	RU	Снятие и установка автокресла	HY	Նստատեղիի հեռացումը և ամրացումը
CS	Vyjmutí a upevnění sedačky	CMN	拆除和安裝座椅	UK	Зняття й установка крісла	VI	Tháo và gắn phần ghế ngồi
SK	Vybratie a upevnenie sedačky	JA	チャイルドシートの取り外しと取り付け				
SL	Odstranjevanje in pritrdjevanje sedeža	KO	시트 제거 및 부착 방법				
HR	Uklanjanje i pričvršćivanje sjedala	BG	Сваляне и закачане на седалката				
HU	Az ülés eltávolítása és behelyezése	SR	Uklanjanje i pričvršćivanje sedišta				



= 31

EN	Backrest	TR	Arkalık
DE	Rückenlehne	EL	Πλάτη
ES	Respaldo	RO	Spătar
FR	Dossier	IS	Bak
PT	Encosto de costas	MT	Serħ id-dahar
IT	Schienale	AR	ميمسد الظهر
NL	Rugleuning	FA	پشتی
PL	Oparcie	YUE	靠背
CS	Opěradlo	CMN	靠背
SK	Operadlo	JA	背もたれ
SL	Naslonjalo	KO	등받이
HR	Naslon	BG	Облегалка
HU	Háttámla	SR	Naslon
SE	Ryggstöd	MS	Penyandar belakang
NO	Rygglene	HI	वेकरेस्ट
FI	Selkänöja	TH	พนักพิง
DA	Ryglæn	SQ	Mbështetësja e shpinës
ET	Seljatugi	BS	Naslon
LV	Atzveltnē	ME	Naslon
LT	Nugaros atlošas	MK	Наслон за грб
RU	Спинка	HY	Թիկնակ
UK	Спинка	VI	Phấn tựa lưng



= 32

EN	Legrest	TR	Bacak desteği
DE	Beinstütze	EL	Στήριγμα ποδιών
ES	Reposapiés	RO	Suport picior
FR	Repose-pieds	IS	Fótahvíla
PT	Apoio de pernas	MT	Serħ is-saqajn
IT	Poggiagambe	AR	ميمسد الساق
NL	Beensteun	FA	جاپایوی
PL	Podnózek	YUE	腿托
CS	Opěrka nohou	CMN	腿托
SK	Opierka nôh	JA	足のせ
SL	Naslon za noge	KO	다리받이
HR	Naslon za noge	BG	Подложка за крака
HU	Lábtartó	SR	Naslon za noge
SE	Benstöd	MS	Tempat letak kaki
NO	Benstøtte	HI	लेगरेस्ट
FI	Jalkatuki	TH	ที่วางขา
DA	Benstøtte	SQ	Mbështetësja e këmbëve
ET	Jalatugi	BS	Naslon za noge
LV	Kāju balsts	ME	Naslon za noge
LT	Kojų atrama	MK	Наслон за нозе
RU	Подставка для ног	HY	Ուղեքրի հեւման կտտ
UK	Опора для ніг	VI	Phấn tựa chân

 = 33

EN	Sun canopy	TR	Güneş başlığı
DE	Sonnenverdeck	EL	Κουκούλα για τον ήλιο
ES	Capota para el sol	RO	Copertină
FR	Pare-soleil	IS	Sólartjald
PT	Capota solar	MT	Kopertura mix-xemx
IT	Parasole	AR	مظلة الشمس
NL	Zonnekap	FA	سایبان
PL	Ostona	YUE	遮陽蓬
CS	przeciwsłoneczna	CMN	遮阳蓬
SK	Stříška proti slunci	JA	日よけカバー
SL	Senčnik za zaščito pred soncem	KO	선 캐노피
HR	Tenda za sunce	BG	Тента
HU	Kupola	SR	Tenda za sunce
SE	Solsufflett	MS	Kanopi matahari
NO	Solskjerm	HI	धूप छतरी
FI	Aurinkokatos	TH	หลังคาบังแดด
DA	Solkaleche	SQ	Strea për diellin
ET	Päikesevari	BS	Tenda za sunce
LV	Saules aizsegs	ME	Tenda za sunce
LT	Stogelis nuo saulės	MK	Стреа за сонце
RU	Солнцезащитный козырек	HY	Որևապաշտպանի օածի
UK	Тент від сонця	VI	Mái che nắng

 = 34

EN	Swivel locks	TR	Tekerlek kilidi
DE	Schwenkradsperre	EL	Περιστρεφόμενες κλειδαριές
ES	Bloqueos de dirección	RO	Încuietori pivotante
FR	Verrous pivotants	IS	Snúningslásar
PT	Bloqueios de rotação	MT	Lokks li jduru
IT	Blocchi girevoli	AR	أقفال دوران العجلات
NL	Zwenkvergrendeling	FA	قفل های نوسان
PL	Blokada obrotu	YUE	旋轉鎖
CS	Aretační zámky	CMN	旋转锁
SK	Aretačné zámky	JA	回転ロック
SL	Blokada vrtenja	KO	회전 잠금장치
HR	Zaključavanje okretanja	BG	Завъртащи се ключалки
HU	Beállás-zár	SR	Zakretni mehanizmi
SE	Vridlås	MS	Kunci ayun
NO	Svingelåser	HI	कुडा ताले
FI	Kääntöluukko	TH	ตัวล็อกแบบหมุน
DA	Drejelås	SQ	Kuçça e rrotave
ET	Pöördlukustus	BS	Zakretni mehanizmi
LV	Rotācijas bloķētāji	ME	Zakretni mehanizmi
LT	Šarnyriniai fiksatoriai	MK	Заклучување на тркалата
RU	Блокировки вращения	HY	Պտտյւղի փոդպիչներ
UK	Замок шарніра	VI	Khóa xoay



= 35

EN	Removing the wheels	TR	Tekerlekleri çıkarma
DE	Entfernen der Räder	EL	Αφαίρεση των τροχών
ES	Quitar las ruedas	RO	Îndepărtarea roților
FR	Retrait des roues	IS	Fjarlægja hjól
PT	Remover as rodas	MT	Tneħħija tar-roti
IT	Rimozione delle ruote	AR	فك العجلات
NL	De wielen verwijderen	FA	باز کردن چرخ‌ها
PL	Zdejmowanie kółek	YUE	拆卸車輪
CS	Odstranění koleček	CMN	拆卸车轮
SK	Odstránenie koliesok	JA	車輪の取り外し
SL	Odstranjevanje koles	KO	휠 제거
HR	Uklanjanje kotača	BG	Демонтиране на колелата
HU	Kerekek eltávolítása	SR	Uklanjanje točkova
SE	Ta bort hjulen	MS	Menanggalkan roda
NO	Fjerne hjulene	HI	फहियों को हटाना
FI	Pyörien poisto	TH	การถอดล้อ
DA	Fjernelse af hjulene	SQ	Heqja e rrotave
ET	Rataste eemaldamine	BS	Uklanjanje točkova
LV	Riteņu atvienošana	ME	Uklanjanje točkova
LT	Ratų nuėmimas	MK	Отстранување на тркалата
RU	Снятие колес	HY	Անհիվանելը հասելը
UK	Зняття коліс	VI	Tháo bánh xe



= 36

EN	Removing the fabric	TR	Kılıfı çıkarma
DE	Entfernen des Bezuges	EL	Αφαίρεση του υφάσματος
ES	Quitar la tela	RO	Îndepărtarea țesăturii
FR	Retrait du tissu	IS	Fjarlægja efni
PT	Remover o tecido	MT	Tneħħija tad-drapp
IT	Rimozione del tessuto	AR	فك القماش
NL	De stof verwijderen	FA	برداشتن پارچه
PL	Zdejmowanie pokrycia	YUE	拆除罩布
CS	Odstranění látky	CMN	拆除罩布
SK	Odstránenie látky	JA	カバーの取り外し
SL	Odstranjevanje blaga	KO	페브릭 제거
HR	Uklanjanje tkanine	BG	Демонтиране на плата
HU	Huzat eltávolítása	SR	Uklanjanje tkanine
SE	Ta bort tyget	MS	Menanggalkan fabrik
NO	Fjerne stoffet	HI	कपड़ा हटाना
FI	Kankaan poisto	TH	การถอดผ้า
DA	Fjernelse af stoffet	SQ	Heqja e copës
ET	Kanga eemaldamine	BS	Uklanjanje tkanine
LV	Pārklājuma atvienošana	ME	Uklanjanje tkanine
LT	Audinio nuėmimas	MK	Отстранување на навлакмата
RU	Снятие ткани	HY	Գործվածքը հանելը
UK	Зняття матерії	VI	Tháo phần vải bọc



EN Carry Cot
DE Kinderwagenaufsatz
ES Capazo
FR Navelle bébé
PT Alcofa
IT Culla portatile
NL Zitbak
PL Gondola wózka dziecięcego
CS Hluboká korba
SK Korba na prenášanie
SL Nosilna košara
HR Ležaljka za prenošenje
HU Mózeskosár
SE Barnvagnslift
NO Babybag
FI Kantolaukku
DA Babylift
ET Vankrikorv
LV Bērnu gultiņa
LT Nešiojamasis lopšys
RU Переносная люлька
UK Переносне дитяче ліжечко

TR Portbebe
EL Πορτ-μπεμπέ
RO Landou portabil
IS Burðarrúm
MT Carry Cot
AR سرير محمول
FA ساک حمل نوزاد
YUE 便攜嬰兒床
CMN 便携嬰兒床
JA 持ち運びベッド
KO 캐리콧
BG Легло за носене
SR Dodatak za kolica
MS Katil Bayi Bimbit
HI कैरी कॉट
TH ตะกร้าที่นอนเด็ก
SQ Djep
BS Dodatak za kolica
ME Dodatak za kolica
MK Кошница за носење
HY Սանկալակն շարժական
VI Nôi xách tay



EN Infant Car Seat
DE Babyschale
ES Silla infantil para coche
FR Siège auto pour enfant
PT Cadeira auto infantil
IT Seggiolino per auto
NL Autostoeltje
PL Fotelik dla niemowlaka
CS Vajíčko
SK Autosedačka pre dojčatá
SL Avtosedež za dojenčke
HR Autosjedalica za bebe
HU Gyermekek autósülés
SE Bilbarnstol
NO Barnebilsete
FI Lasten istuin
DA Autostol
ET Imiku turvatool
LV Zīdaiņu sēdekļis
LT Automobiline naujagimio kėdutė
RU Детское автокресло
UK Автокрісло для немовлят

TR Bebek Araba Koltuğu
EL Παιδικό κάθισμα αυτοκινήτου
RO Scaunul auto pentru infant
IS Smábarnabílstóll
MT Sit tal-Karozza tat-Tfal
AR مقعد سيارة للرضع
FA صندلی خودرو برای نوزاد
YUE 嬰兒汽車座椅
CMN 婴儿汽车座椅
JA 幼児用カーシート
KO 유아용 카시트
BG Бебешка седалка за автомобил
SR Auto sedište za bebe
MS Kerusi Keselamatan Bayi
HI शिशु कार सीट
TH คาร์ซีทสำหรับเด็กทารก
SQ Sexholino
BS Auto sjedište za bebe
ME Auto sjedište za bebe
MK Детско седиште за автомобил
HY Ավտոմոբիլային մանուկային նստատեղի
VI Ghế xe dành cho trẻ sơ sinh



EN	Rain cover	TR	Yağmurluk
DE	Regenverdeck	EL	Καλύπτρα βροχής
ES	Funda para la lluvia	RO	Prelată de ploaie
FR	Housse de pluie	IS	Regn yfirbreiðsla
PT	Capa de chuva	MT	Għata mix-xita
IT	Parapioggia	AR	غطاء المطر
NL	Regenhoes	FA	روکش باران
PL	Osłona od deszczu	YUE	防雨罩
CS	Pláštěnka	CMN	防雨罩
SK	Kryt proti dažďu	JA	雨ふけ
SL	Dežna prevleka	KO	레인커버
HR	Pokrivač za kišu	BG	Дъждобран
HU	Esővédő	SR	Pokrivač za kišu
SE	Regnskydd	MS	Pelindung hujan
NO	Kalesje	HI	रेन कवर
FI	Sadesuoja	TH	ผ้าคลุมกันฝน
DA	Regnslag	SQ	Mbulesë për shiun
ET	Vihmakate	BS	Pokrivač za kišu
LV	Pretlietus pārvalks	ME	Pokrivač za kišu
LT	Uždangalas nuo lietaus	MK	Прекиривка за дожд
RU	Дождевик	HY	Անձրևապաշտպան ծածկ
UK	Дощовик	VI	Tấm che mưa

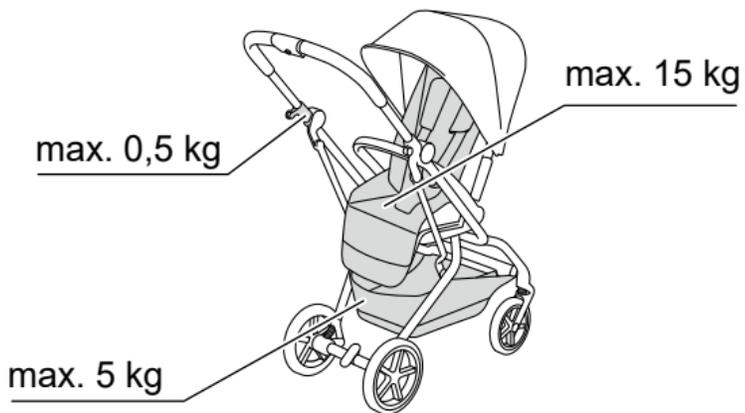

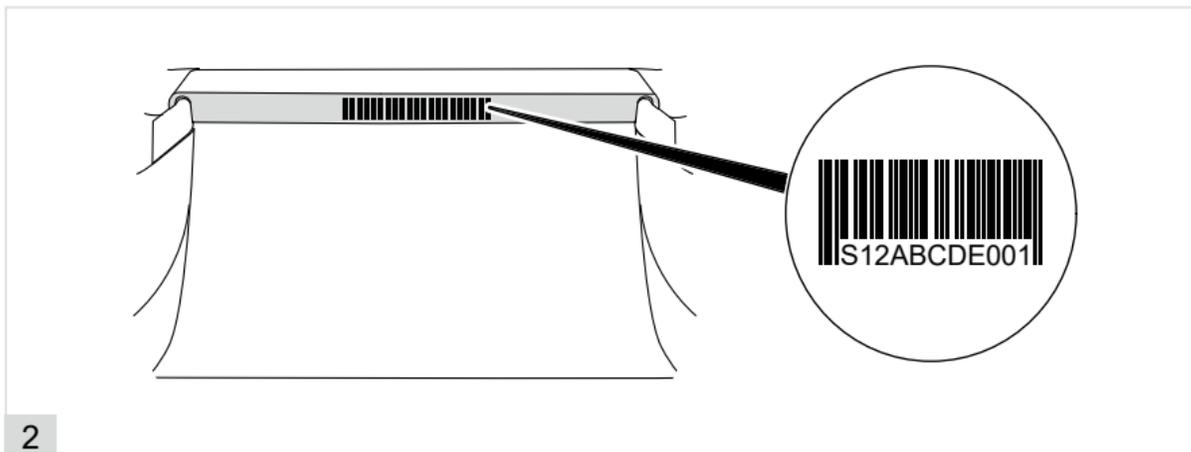
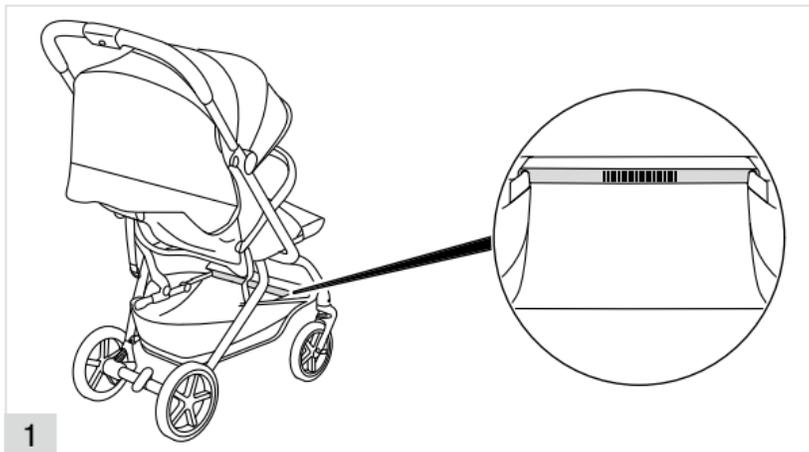

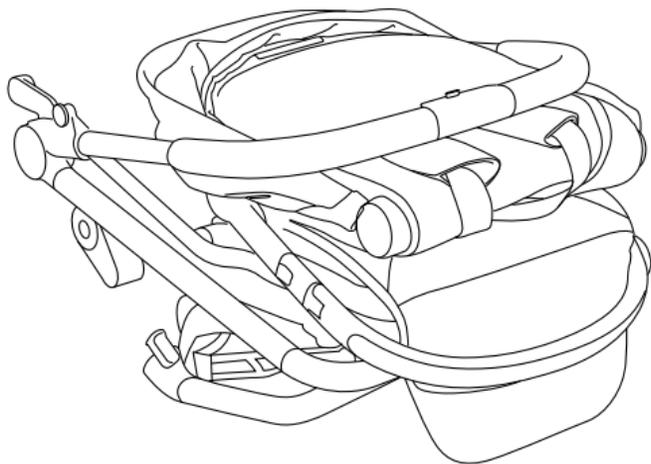

OPTIONAL

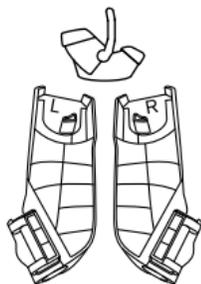

OPTIONAL

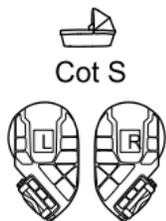

OPTIONAL

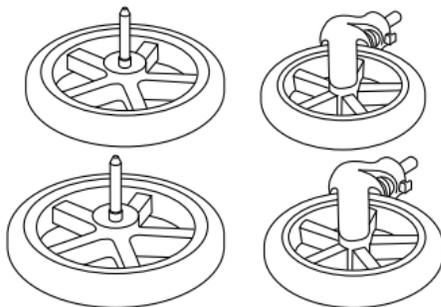

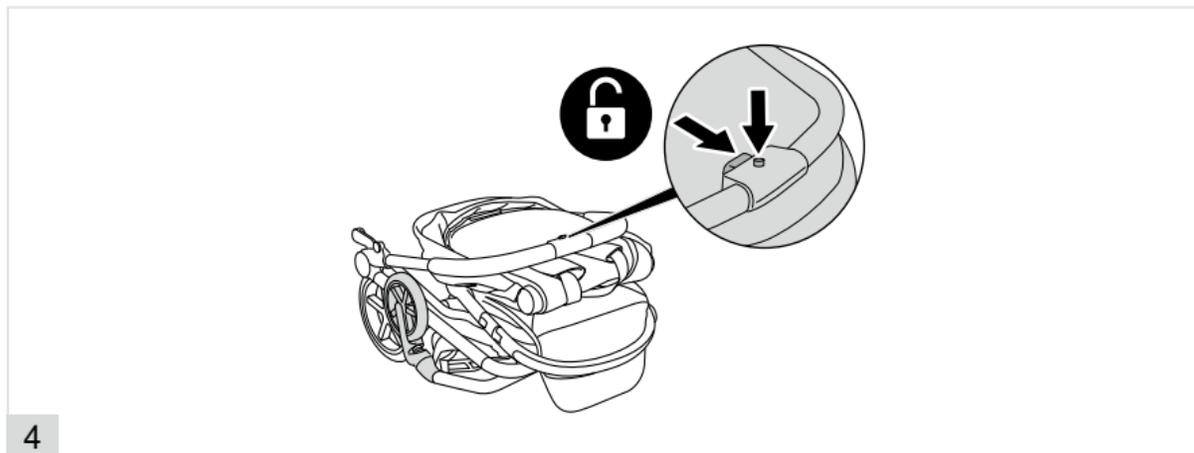
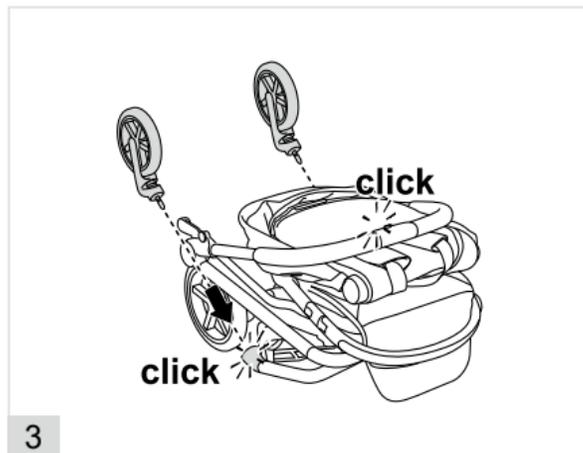
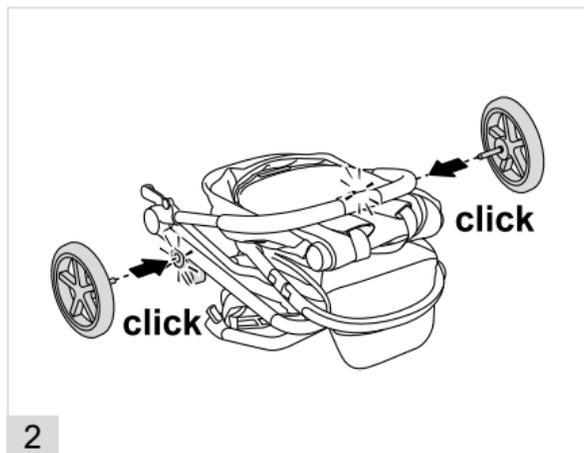

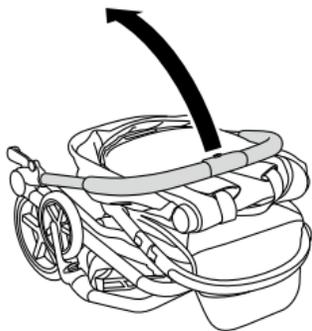

5

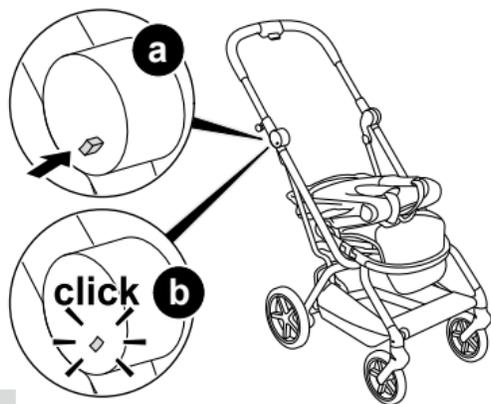

6

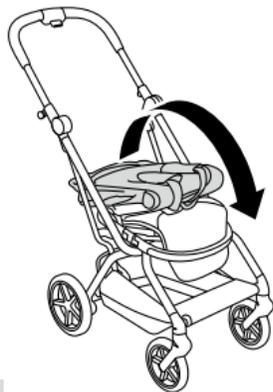

7

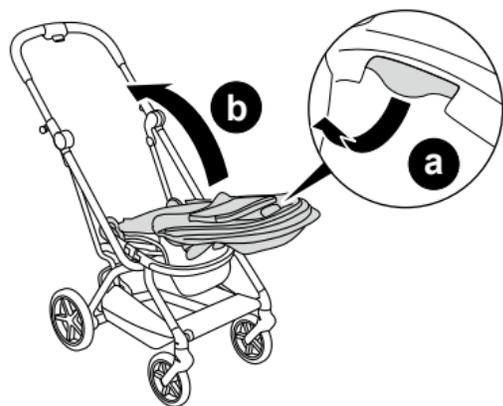

8

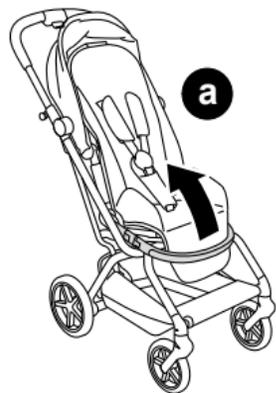
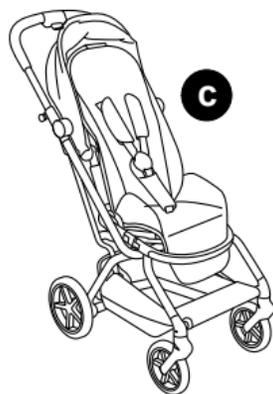

9

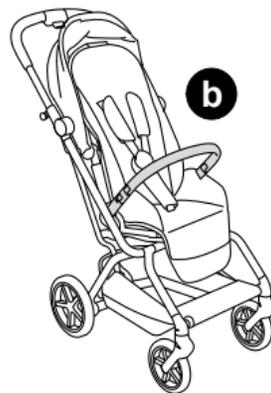

19



10



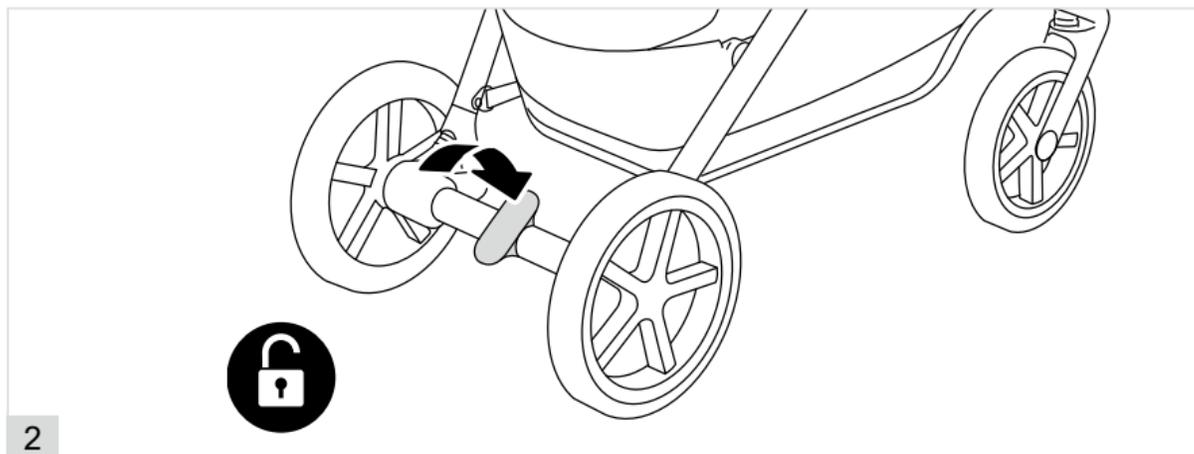
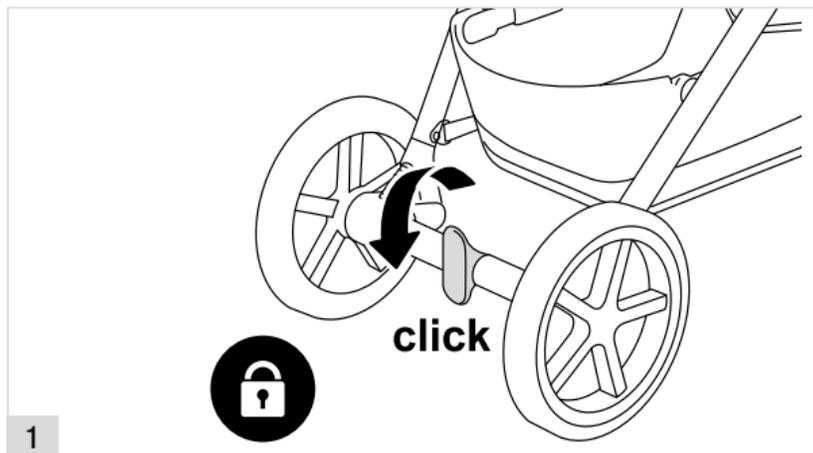

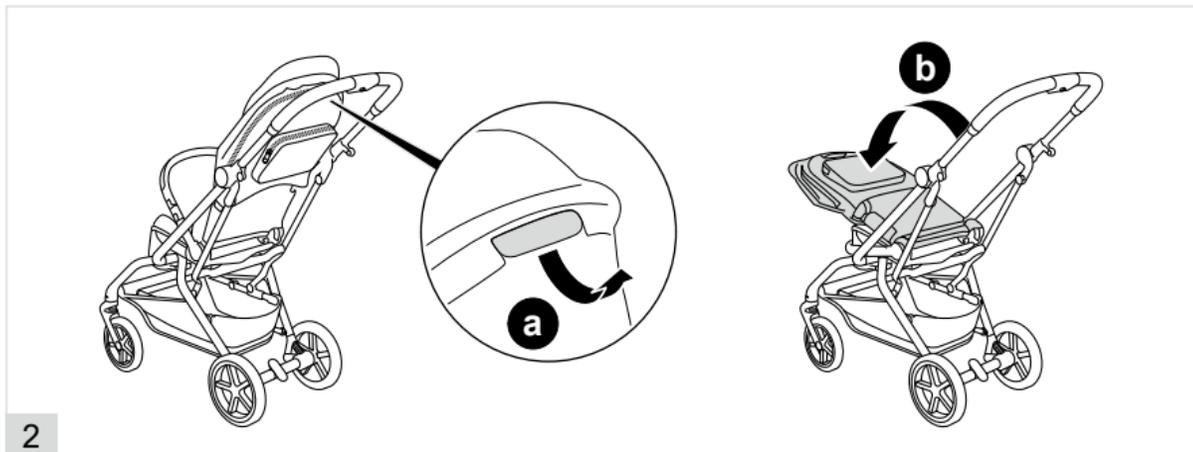
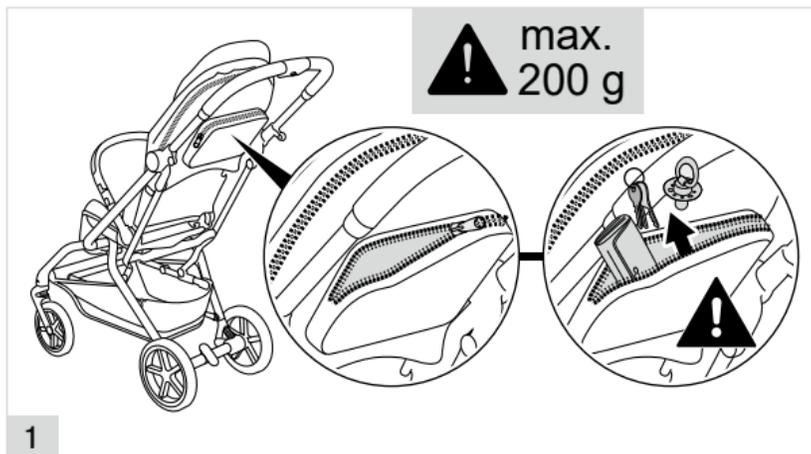



3

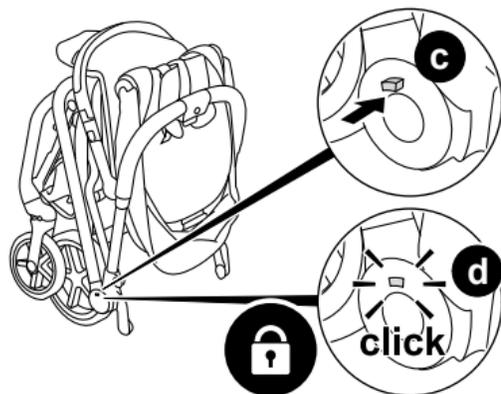
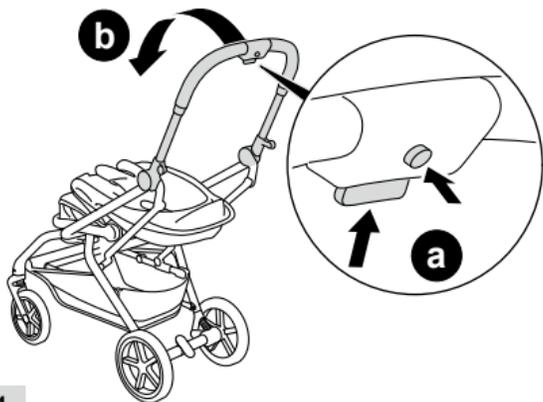

4

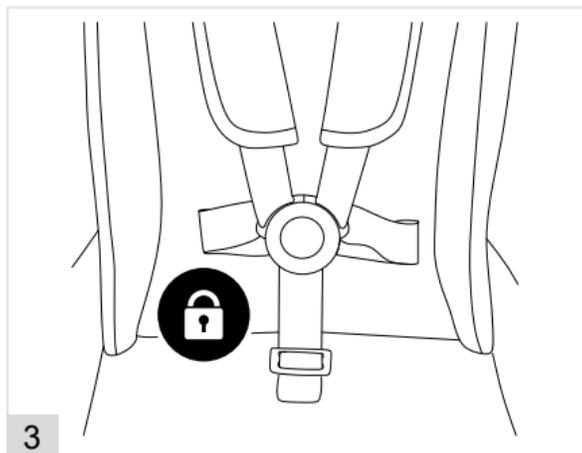
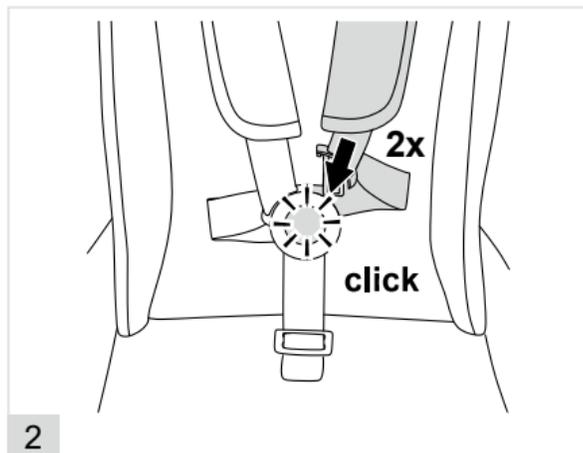
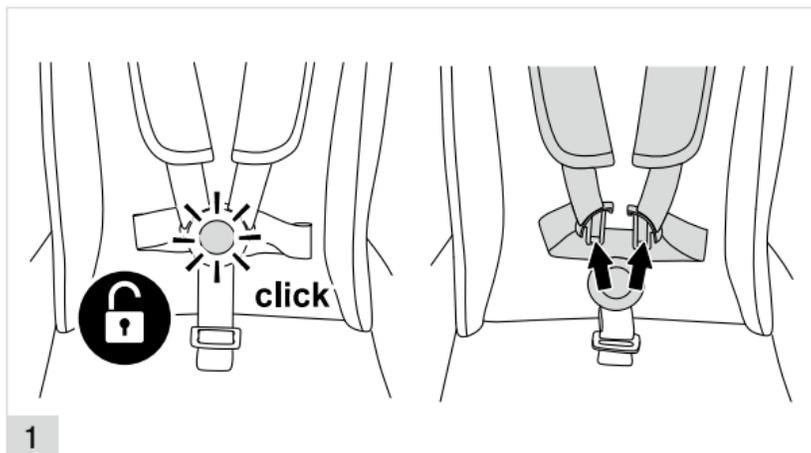

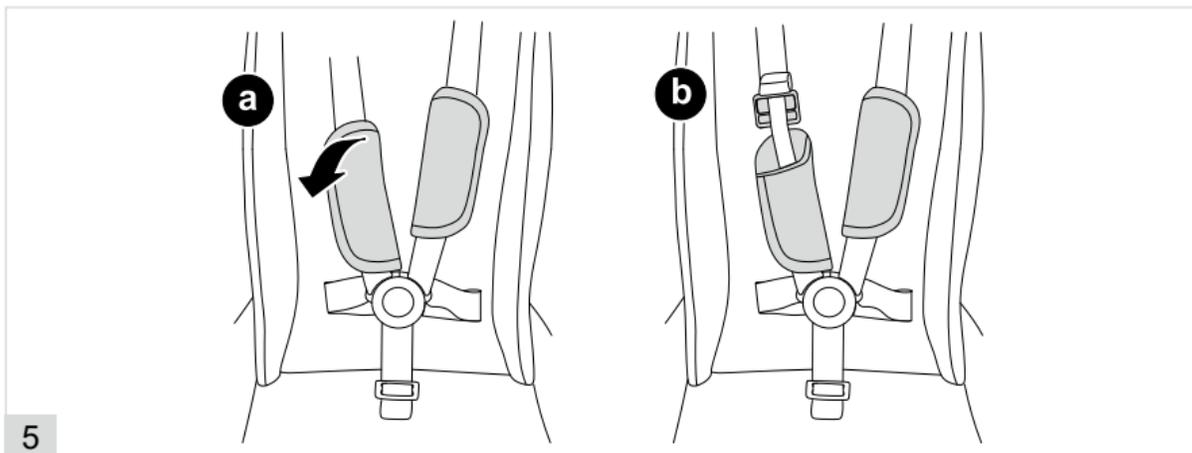
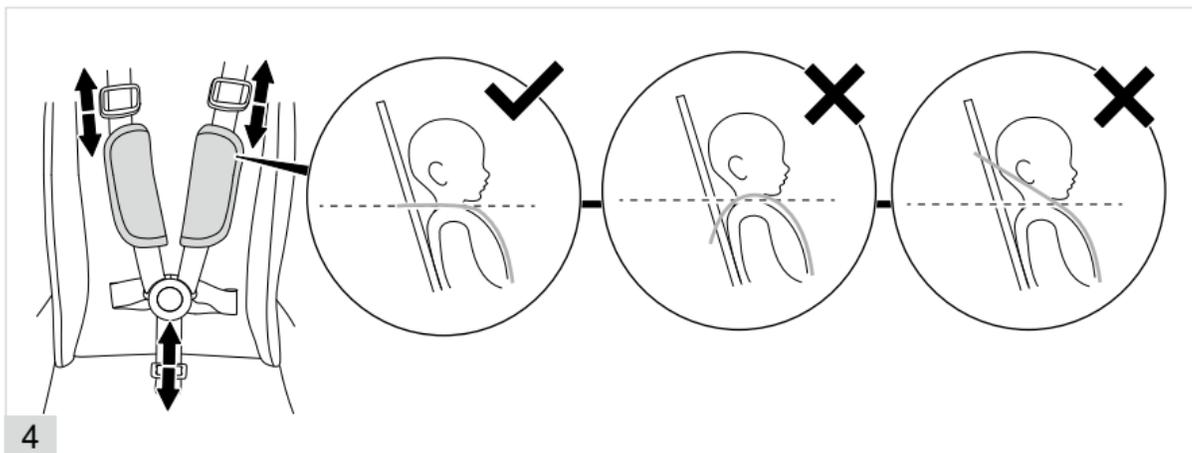

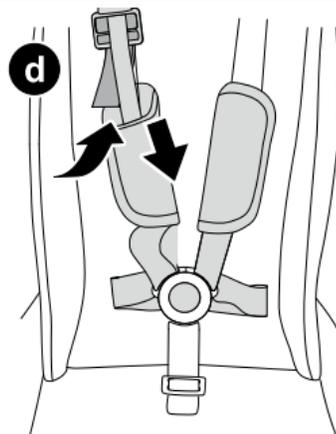
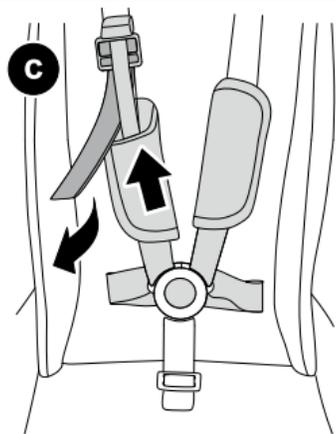

6

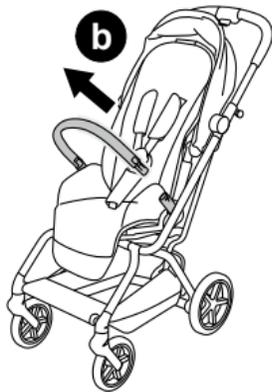
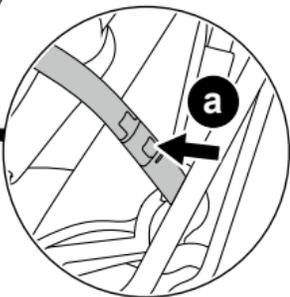

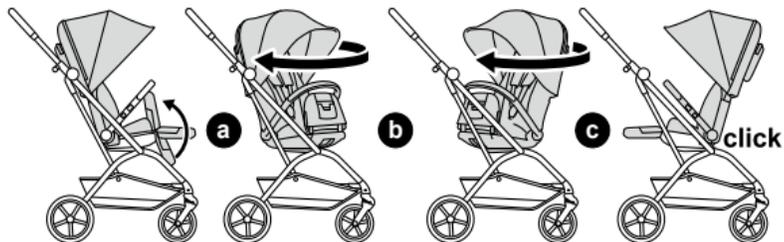

1

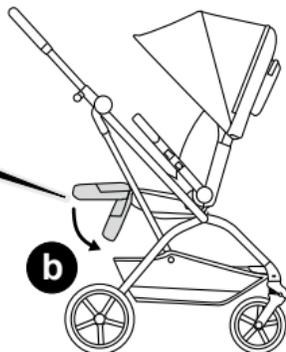
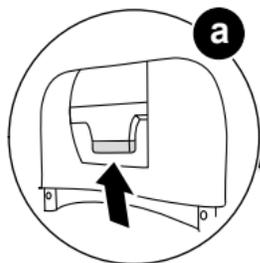

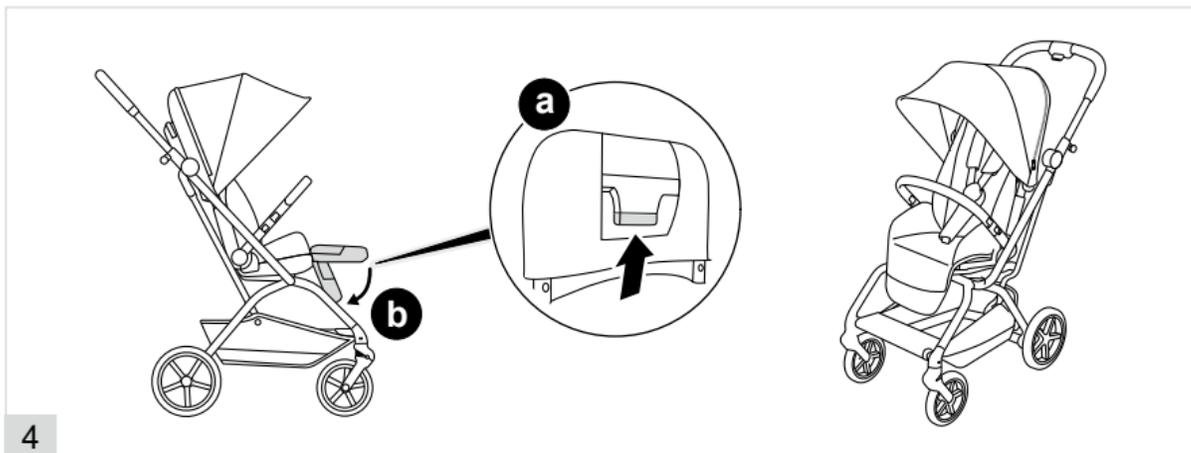
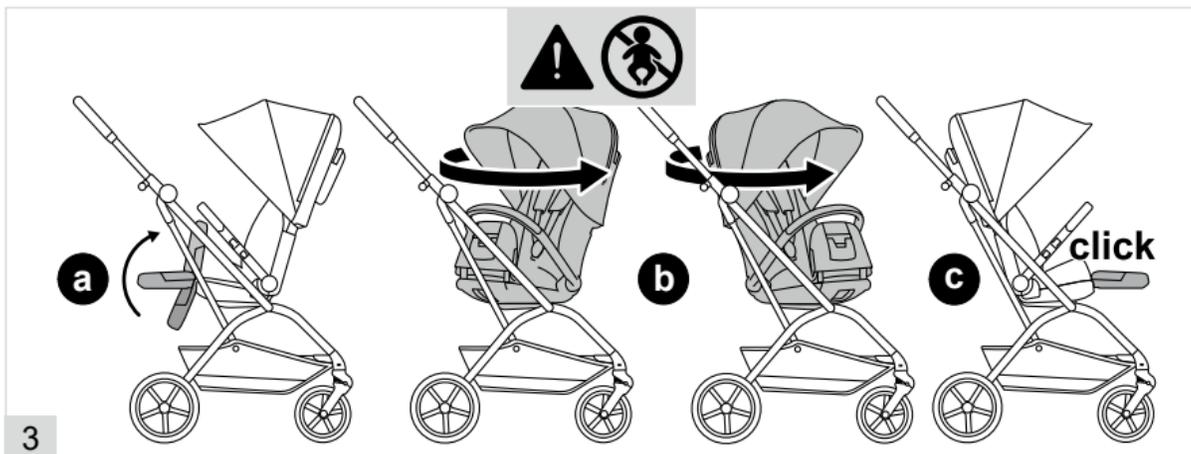

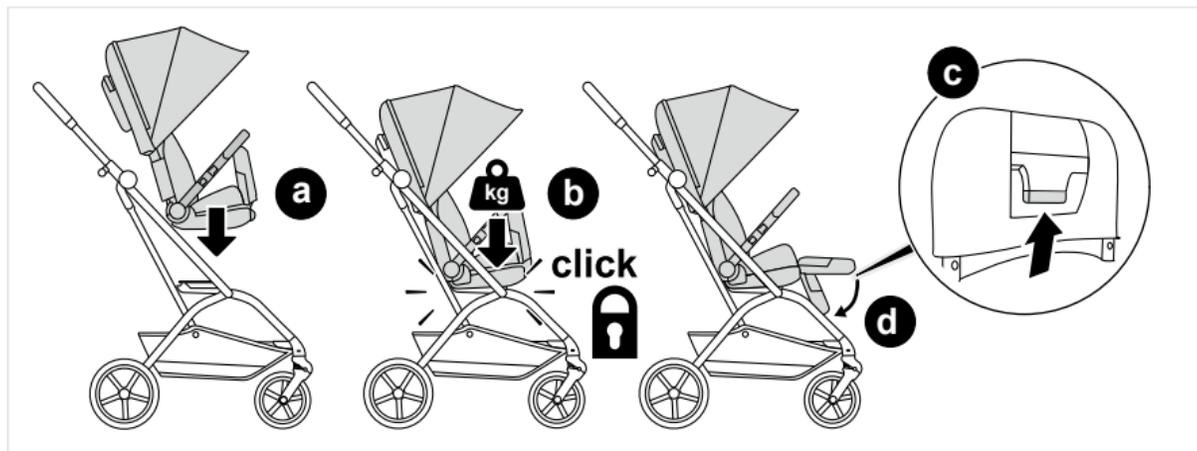
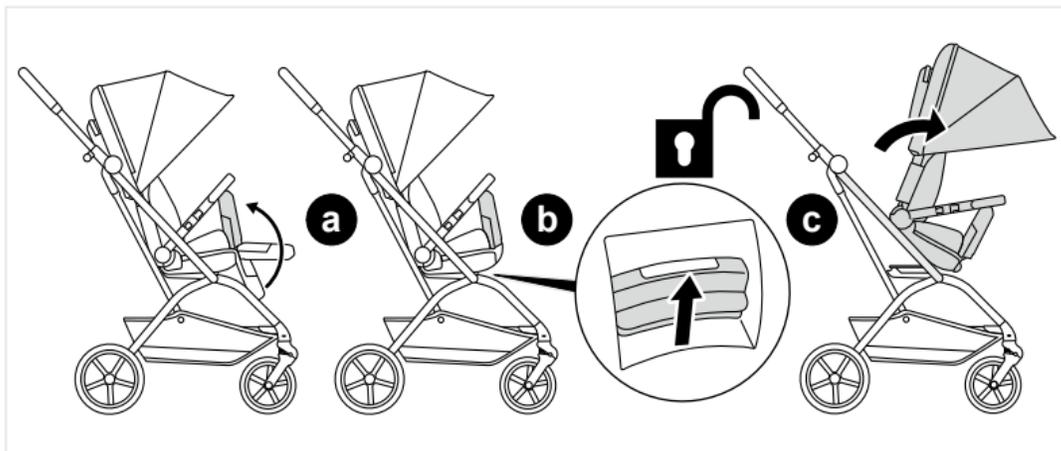

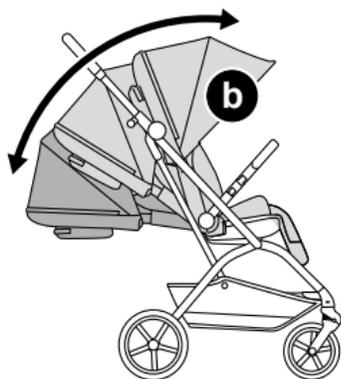
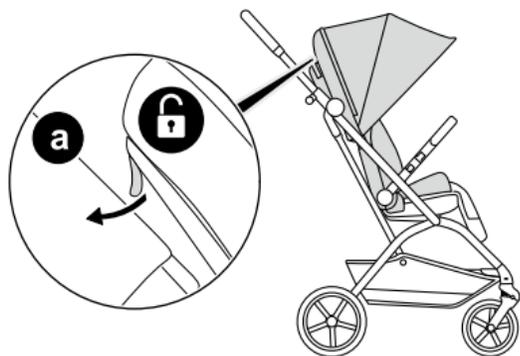

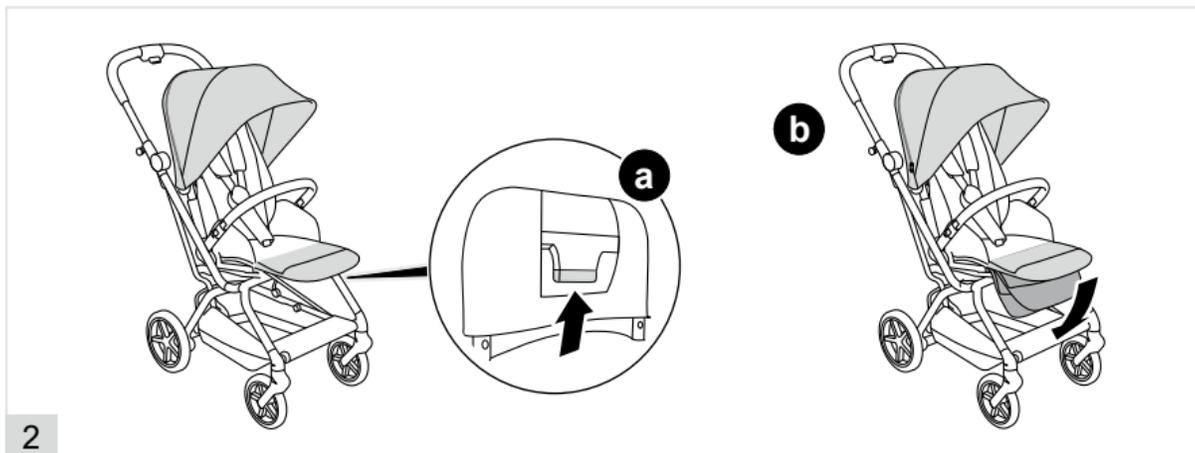
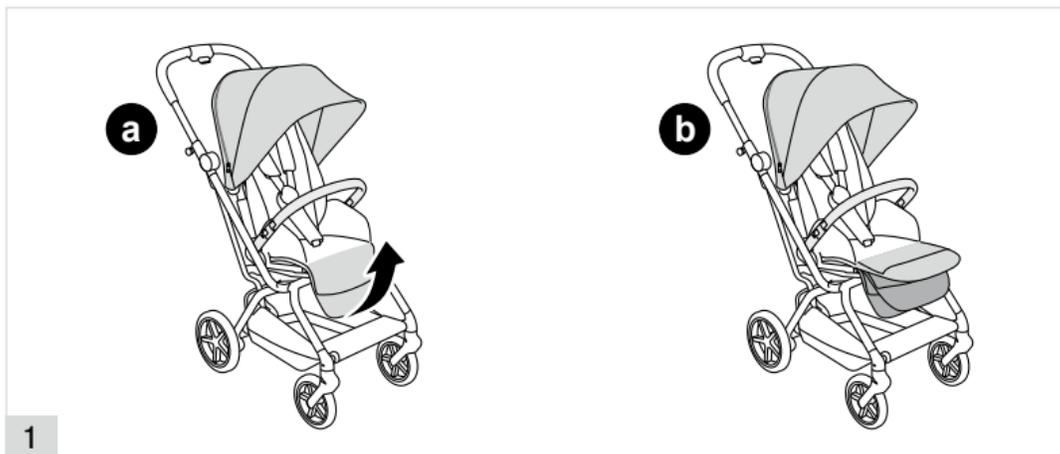

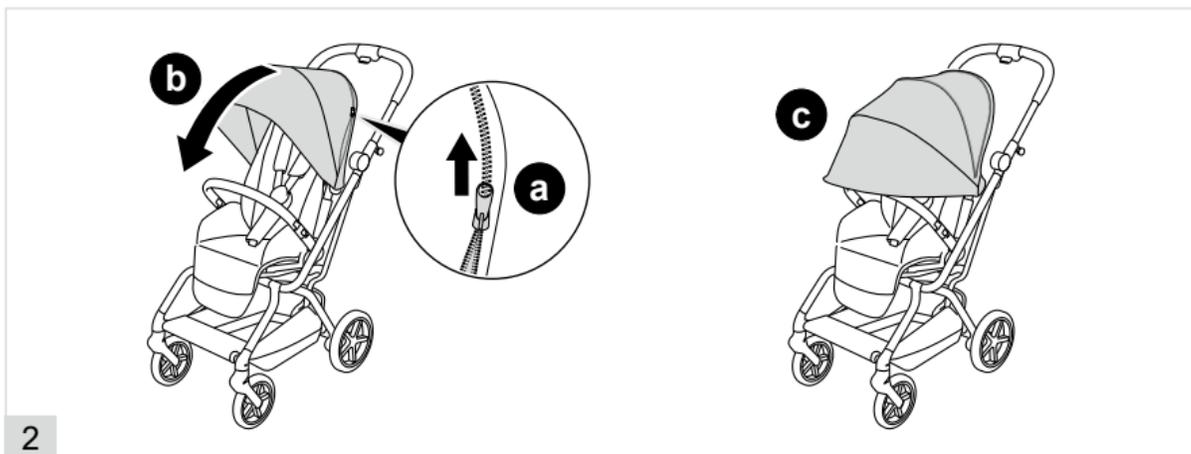
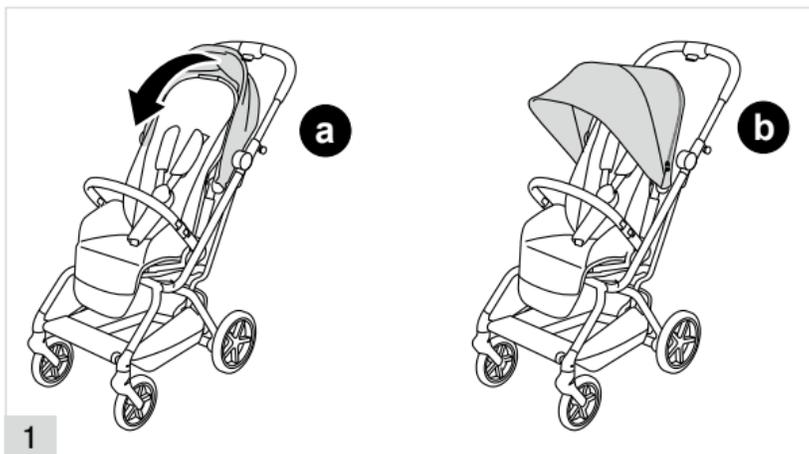

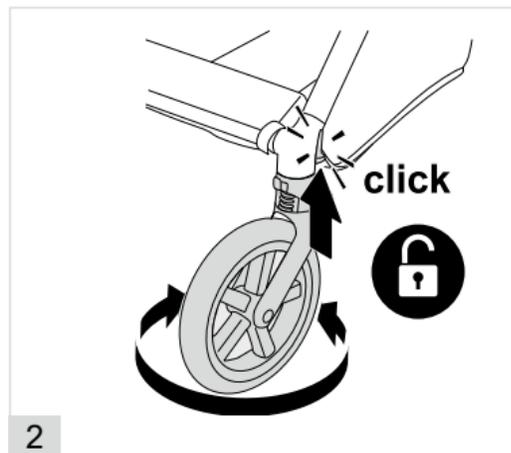
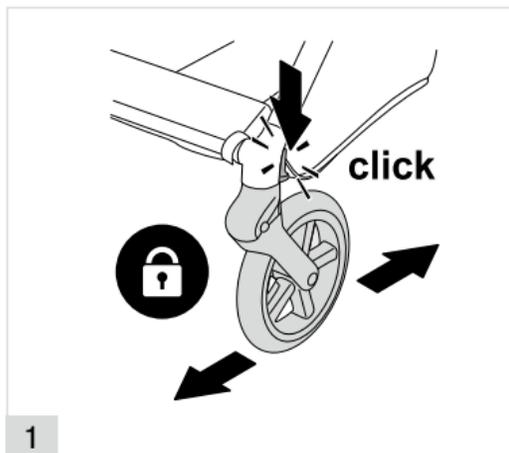

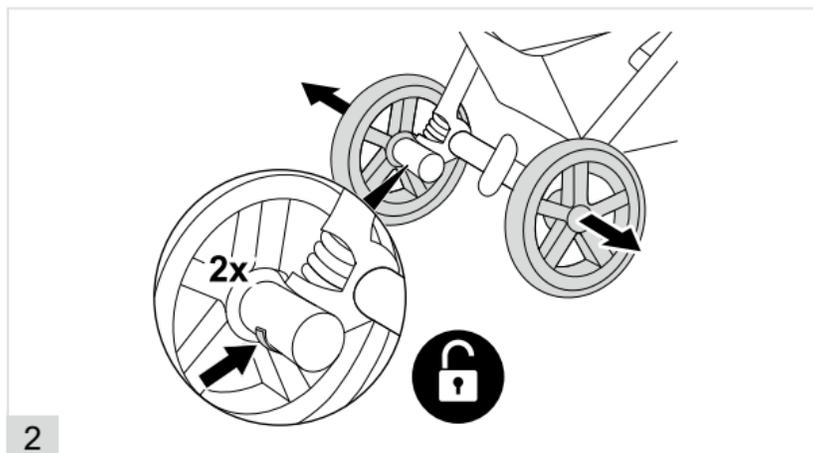
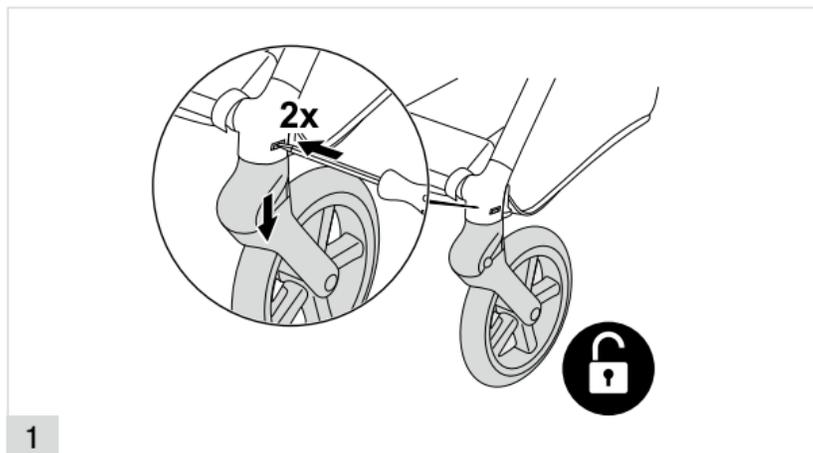

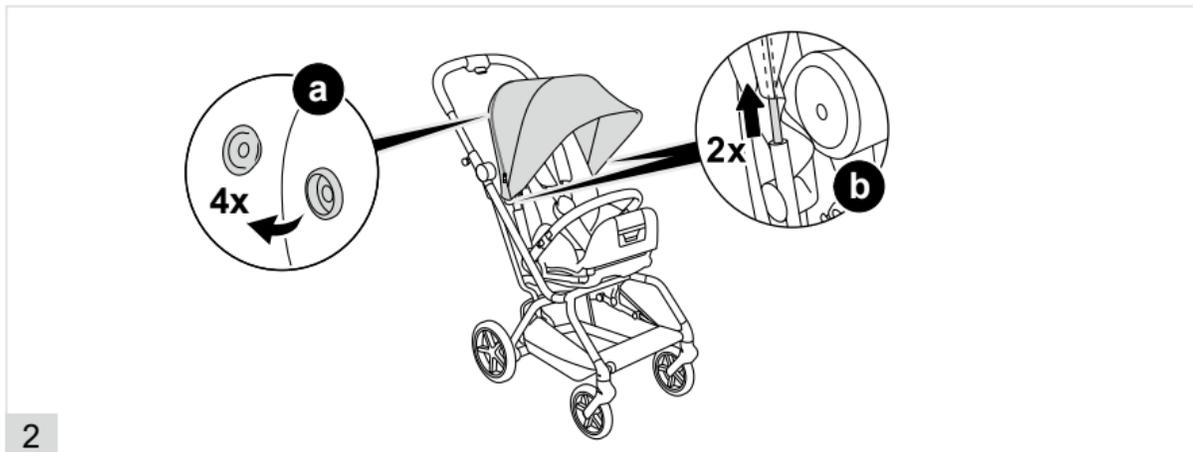
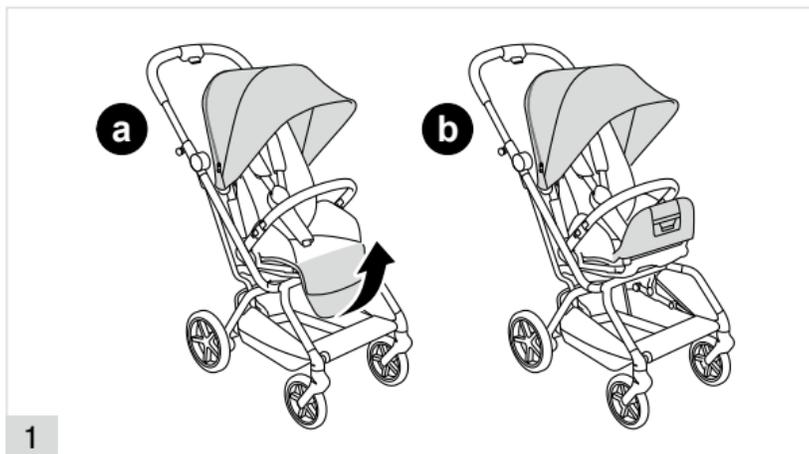

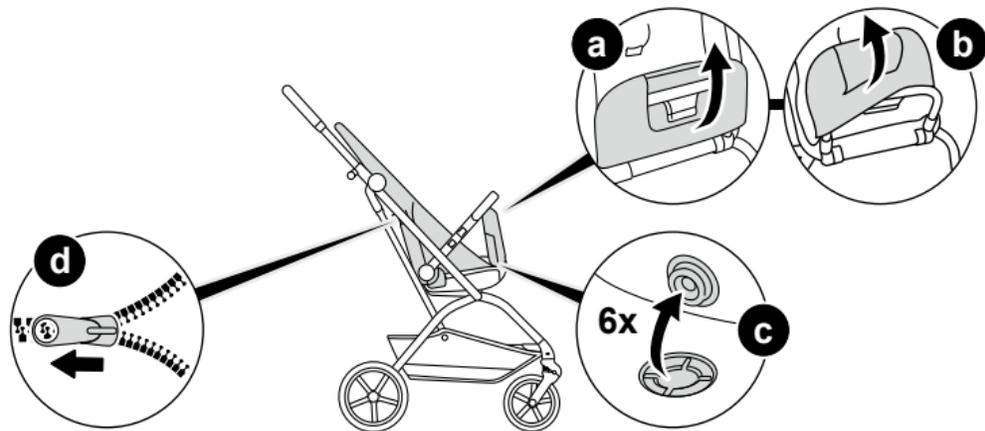

3

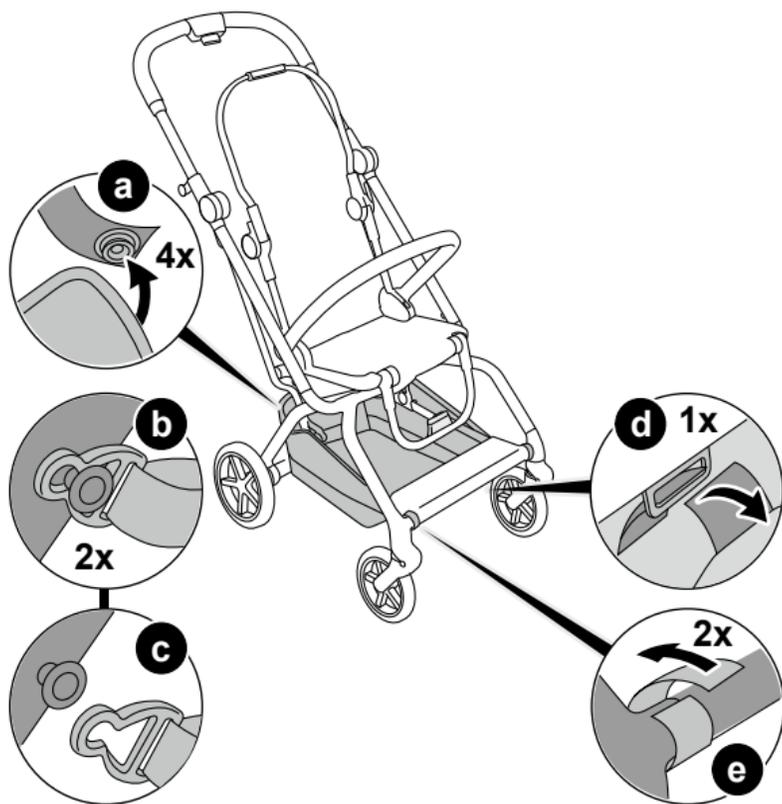

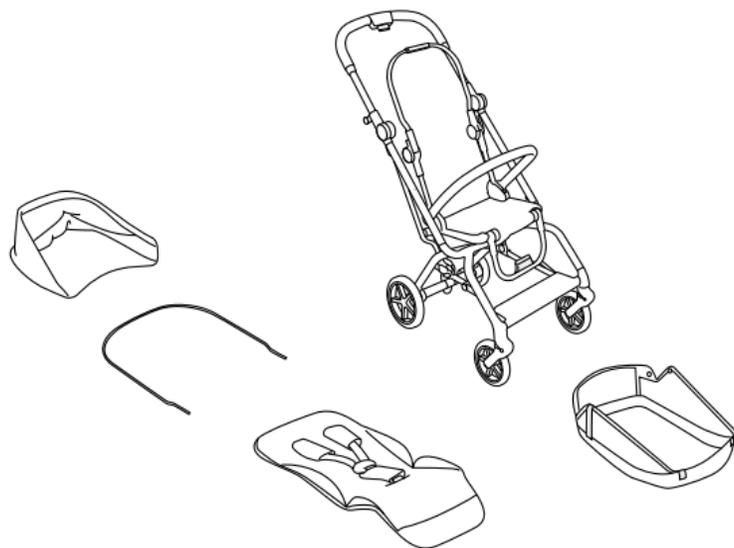



1

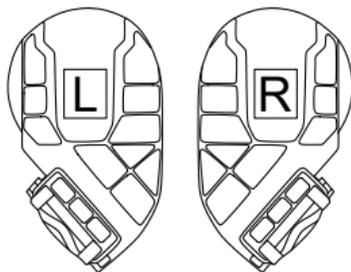

2

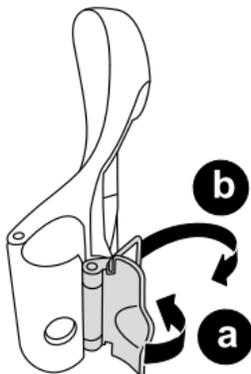



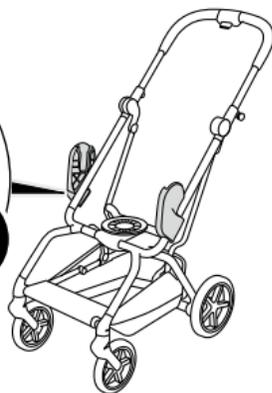
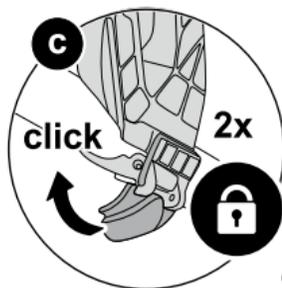
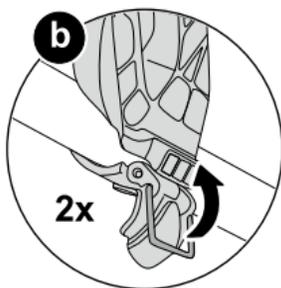
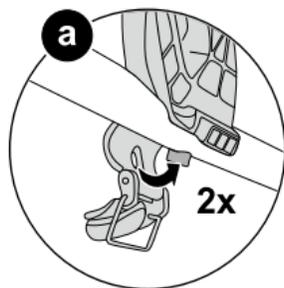

7



42

8

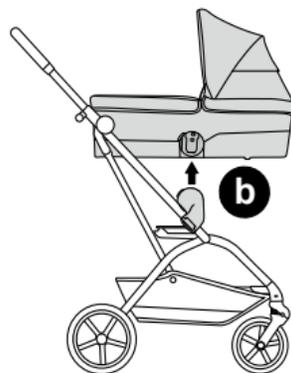
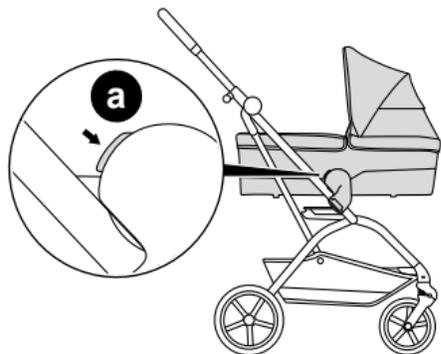

9



1

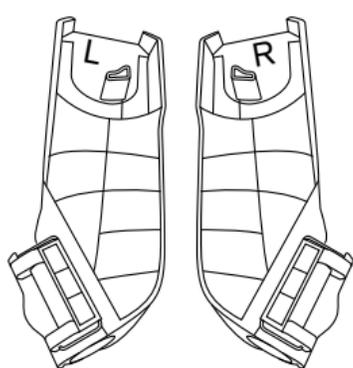

2

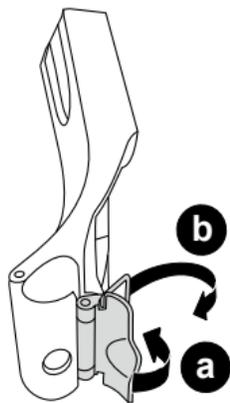

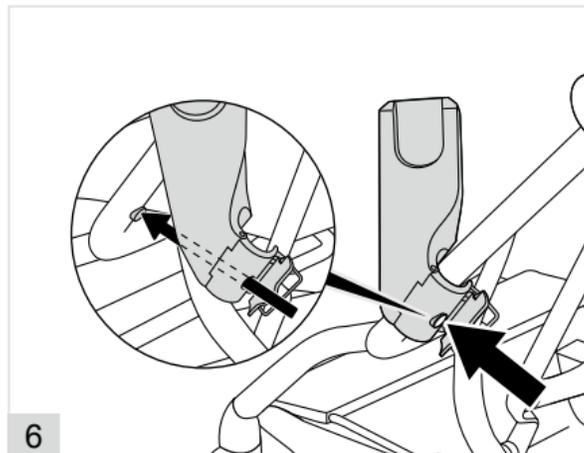
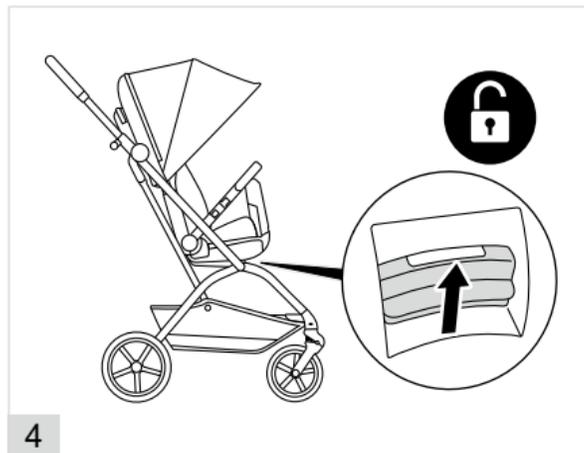

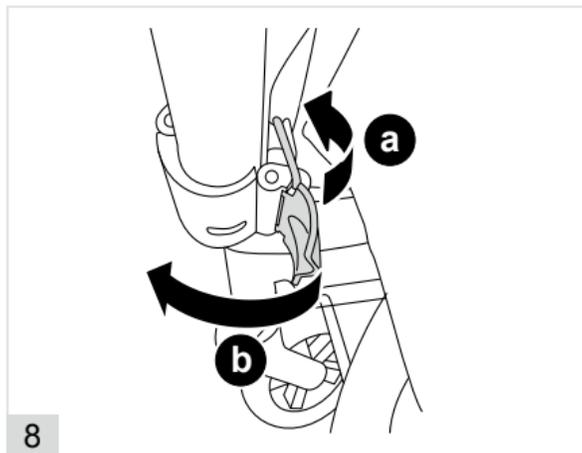
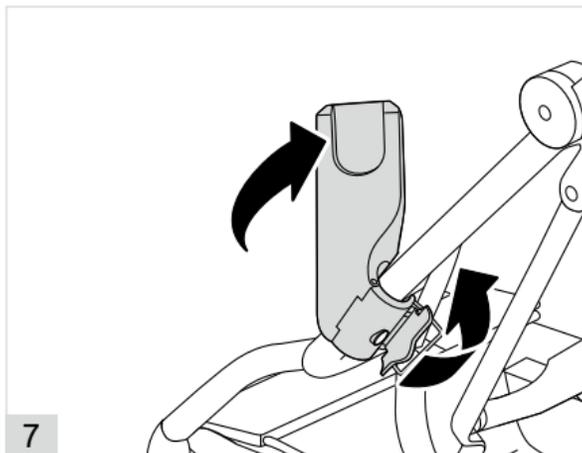





1



2

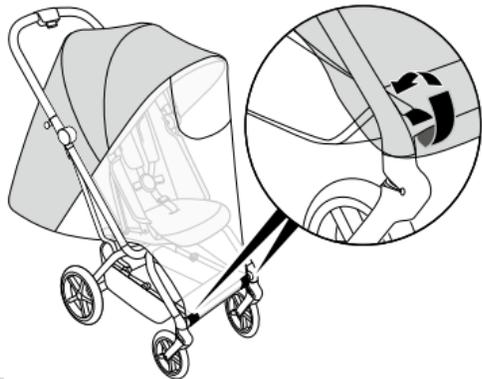

3

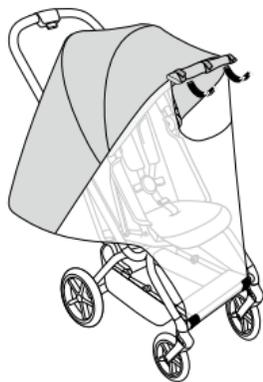

4



CYBEX GmbH
Riedingerstr. 18 | 95448 Bayreuth | Germany
+49 (0) 921-78 511-0 | info@cybex-online.com

www.cybex-online.com

