



USER GUIDE

Contents

Brief Introduction	1
Hardware	2
Standard Configuration	2
Buttons & ports	3
System Specification	4
Connection of Sensor Modules	5
Stand-alone Mode	5
Interface of Built-in Software	6
Function	6
Usage of Combination with Other Systems	9
Connection Modes	9
Usage of Windows&Mac OSX System	9
Usage of Android Platform	11
Usage of iOS Platform	13
Notes	15
Clean	15
Applicable environment	15
Storage	15
Attentions	15
Reset	15
Common problems and their solutions	16
Configure Table of Sensor Modules	17

Brief Introduction

1

SenseDisc is a new concept of portable digital experimental system with powerful function, which is available to the experimental teaching of primary and secondary schools all over the world. Equipped with wireless & exquisite sensor modules, create a simple and safe experimental environment for students, and they can explore the science world as they wish.









SenseDisc is a multi-channel data logger, the entire outward appearance designs succinctly naturally and human friendly. Every sensor modules are set around data logger flexibly, and has its own independent connection port, not stereotypical. Each series of SenseDisc data logger, has built-in accelerometer (3 Axis), GPS, ambient temp and barometer, more diversified and high efficient.

SenseDisc adopts 3.5" TFT 480*320 touchscreen, and a built-in 1800mAh lithium battery (over 6 months of standby time). SenseDisc has two acquisition modes to choose from, stand-alone and external equipment mode. When connect to an external equipment, can supports the Windows, Android, Mac OSX and iOS operating systems, and provided wired mode and wireless linking methods.

Hardware

2

Standard Configuration

NO.	Name	Picture
1	SenseDisc Data Logger	
2	Screen Stylus	
3	USB Cable	
4	Power Adapter	
5	Universal Joint	
6	Aluminium rod	
7	Software CD	
8	Manual	
9	Bag	

Buttons & ports

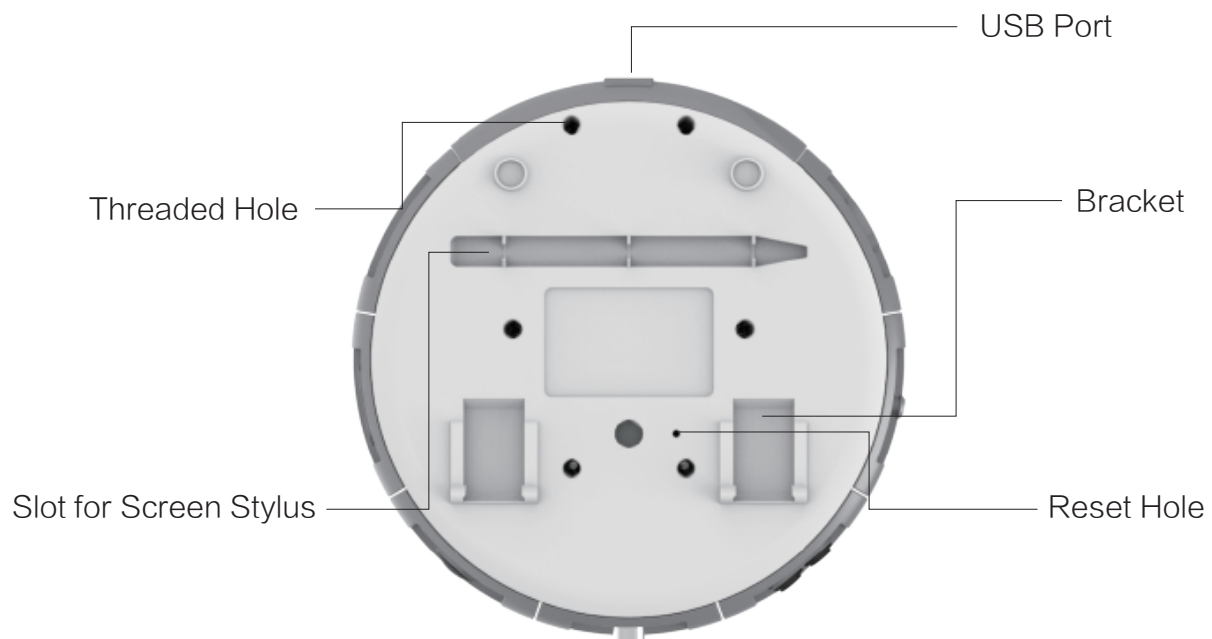

System Information

3

Item	Specification
Platform	Stand-alone mode, Windows, iOS, Android, Mac and etc.
Built-in sensors <small>(Each series of different configuration)</small>	Accelerometer (3 Axis), GPS, ambient temp, barometer and etc.
GPS	✓
Stand-alone mode	✓
Max sampling rate	100,000 times/s
Sampling Resolution	12-bit
Storage	4M
Battery	1800 mAh lithium battery
Stand-by	> 6 months
Screen	3.5' TFT 480*320 touch screen
Port	USB 2.0
Wireless connection	✓
Size	$\phi=170\text{mm}$, H=46mm
Temperature Range	-20~70 ° C
Power Adapter	100~240V AC / 5V DC 1A
Software	SenseDisc iLab
Sensor Port	7

Connection of Sensor Modules 4

SenseDisc uses surround-type design philosophies, namely the sensor modules and the data logger to form a circle-type connection, 7 sensor modules can be connected to the main body simultaneously; Using pluggable measuring modulus, and these modulus can according the requirements of experiment to be combined freely.

When in usage, only need to insert one module into any port of the main body. Indicated as follows:

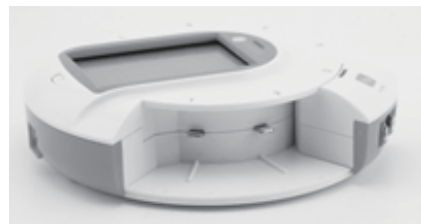

Stand-alone Mode

5

Before the first usage, please make ensure the power is enough! In the case of power shortage and power unknown, please charging or connect to power supply. When in charging, 1st, connect the USB cable to the power adapter; 2nd, connect the USB cable to the USB port of main body; 3rd, connect the power adapter to power source. Or, connect the USB cable to computer.

Power on: long press the power button until the screen lit, and determines the indicator light of sensor were lit (the state of sensor communication can be controlled via the built-in software: when connecting to a sensor, the indicator light is bright; Otherwise off).

Power off: long press the power button until the screen turned off, and the indicator light off.



Interface of Built-in Software

After starting up the SenseDisc, enter into the Home page, you can find the status bar, major functional areas and function button.

Status bar: display the date&time, battery, USB, Bluetooth, charging state, sign of experimental acquisition and etc.

Major functional areas: contains collect, setting, experiment and system info.

Function button: the Home page will display our logo; other pages will show the Return button.

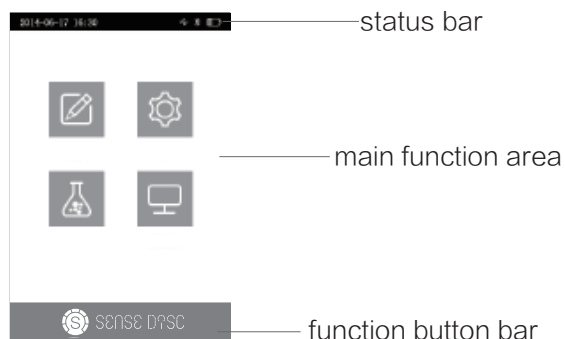

Function

Collect

click this icon , SenseDisc will identify the connected sensor automatically, and real-time display the acquired data of sensor.

The opened interface will show the information of connected sensor modules, such as name, real-time value and etc. For instance:



Click this icon  or the Power button, will back to the Home page;
 Click on any one of the sensor channel, can show the detail information of the corresponding sensor and in three types: digital, bar, meter (e.g. current sensor):

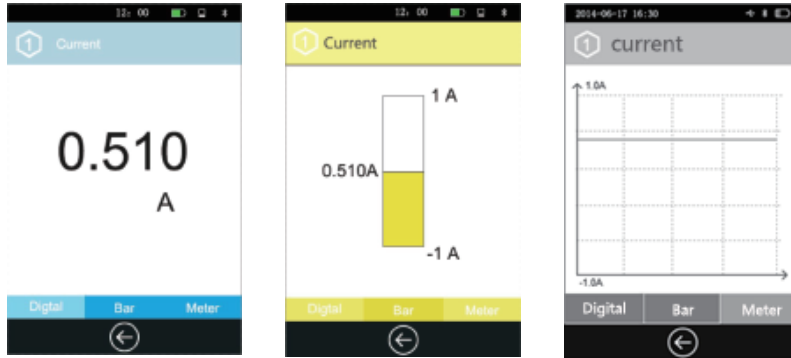

Click this icon  or the Power button, will back to the previous interface.

Setting

 : Setting of SenseDisc:

Click this icon  to enter into the setting interface:

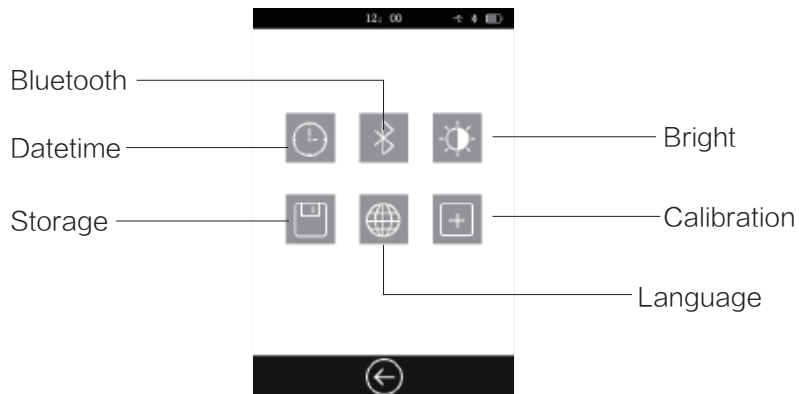

Datetime: can set the date & time;

Bluetooth: turn on or off the Bluetooth communication, mainly used to connect with external device;

Bright: set the brightness;

Storage: save the experimental data and import it to external device for detailed analysis;

Language: switch language;

Calibration: calibrate the accuracy of screen;

Click this icon  or the Power button, will back to the Home page.

Experiment



: Setting the experimental time and data acquisition frequency. The default frequency is 1/s and with 20 samples.

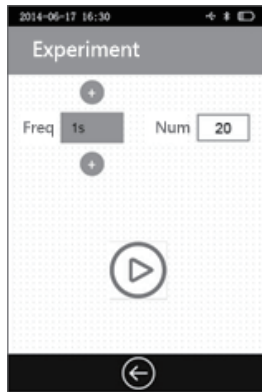

Click this icon , system will start data acquisition; after completing the acquisition, experimental data will be saved automatically.

Click this icon  or the Power button, will back to the Home page.

System Information



: Contains basic info., sensors info. and software info. of SenseDisc.

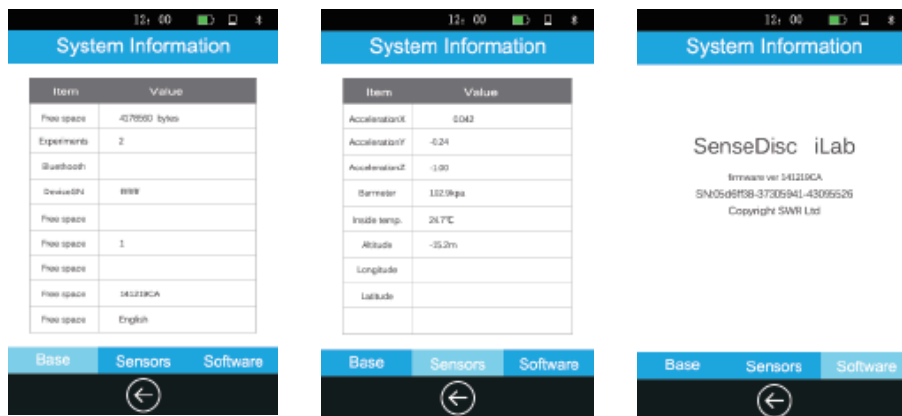

Click this icon  or the Power button, will back to the Home page.

Usage of Combination with Other Systems

6

SenseDisc not only support the stand-alone mode, also support wired and wireless connection mode. Multiple operating platforms like Windows, Mac OSX, Android, iOS, can realize the real-time data acquisition via combined with PC, laptop and ipad.

There is a briefly introduction as follows, and the detailed instructions please refer to SenseDisc iLab software manual.

Connection Modes

Connection mode	Windows	Mac OSX	Android	iOS
Wired	✓	✓	✓	✗
Wireless	✓	✓	✓	✓

Usage of Windows&Mac OSX System

Wired Connection

Connect SenseDisc to computer by USB cable:



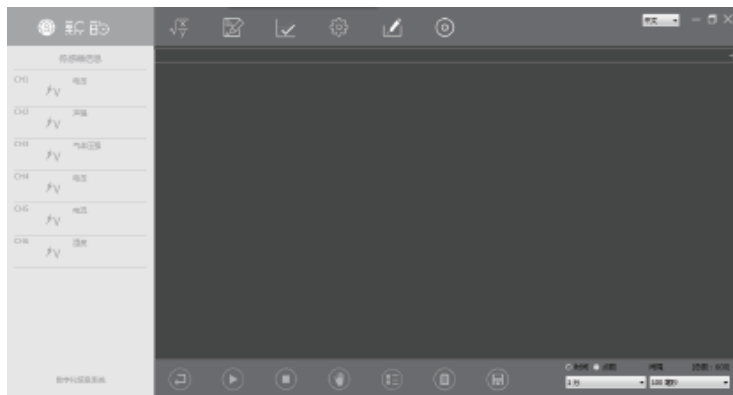

Click the software icon  , enter into the main interface:

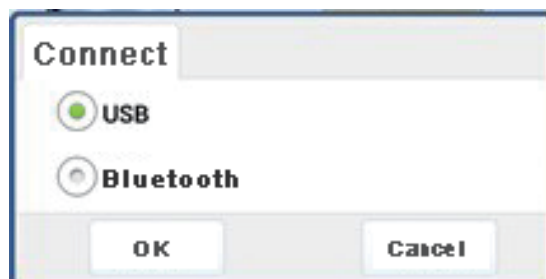

Click this icon  , choose “USB” , click “OK” :





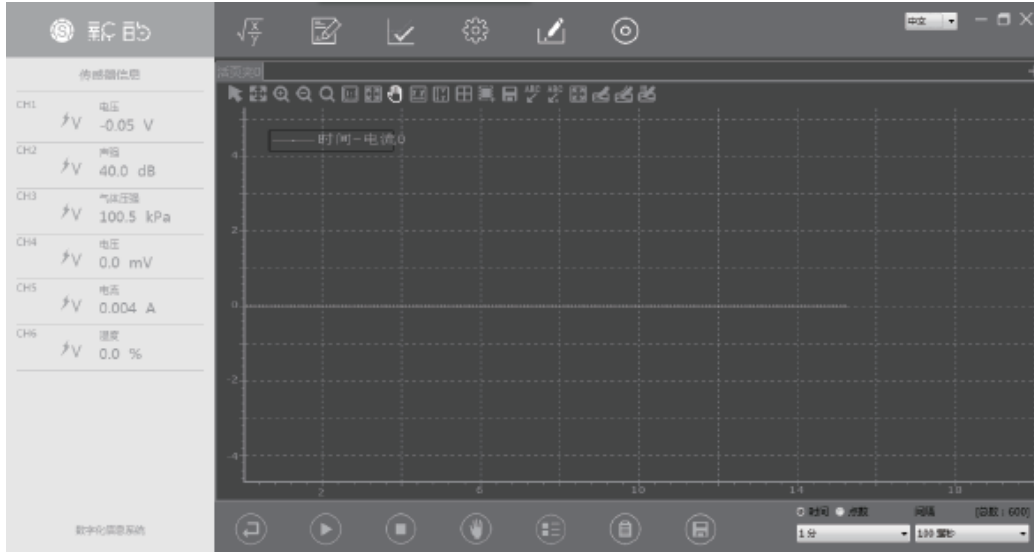

For example, click this , choose “current” , click “OK” , set the “Current–Time” coordinate system, then click this icon  to start data acquisition:



Wireless Connection

Please make sure the power is sufficient before use!

Starting up the SenseDisc, choose  in , slide to open Bluetooth ; Click the software icon , click  in the Home page, choose “Bluetooth” then click “OK” ; other steps are same with the wired connection:



Usage of Android Platform

Wired Connection

Connect the SenseDisc to the Pad datalogger(Android) by USB cable, as follows:



Click the software icon  , enter into the Home page:



Click  , choose “Bluetooth” , then click “OK” :

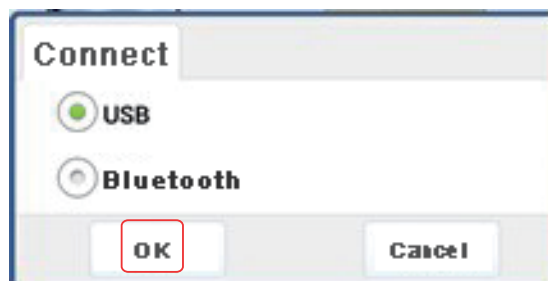

Click , enter the experimental page:



Choose template , enter experimental platform:



Click , (for example: current), choose “current”, click “OK”, create the “Current–Time” coordinate system:



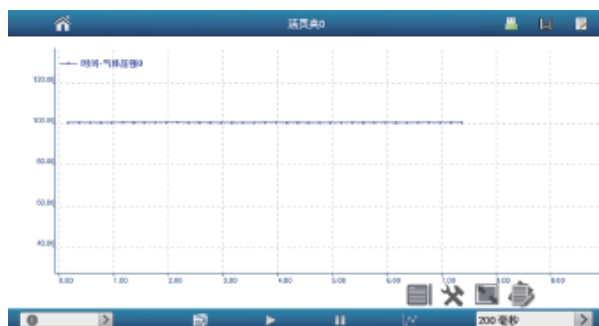

Click , start data acquisition:



Wireless Connection

Before use, make ensure the power is enough!

Starting up the SenseDisc, choose  in , slide to open Bluetooth  ;

Click , click , choose “Bluetooth”, then click “OK” ; other steps are same with wired connection:

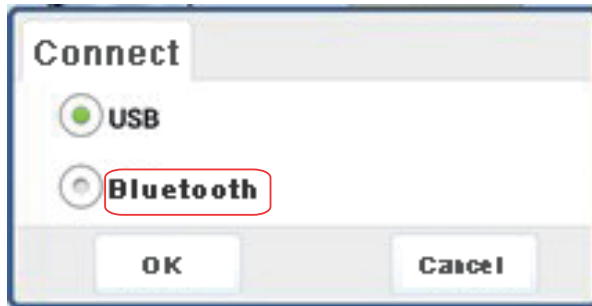

Usage of iOS Platform



Before use, make ensure the power is enough!

Starting up the SenseDisc, choose  in , slide to open Bluetooth ;

Open the software  in iPad, enter into the experimental page:



Choose , choose “Bluetooth” in “Setup” :

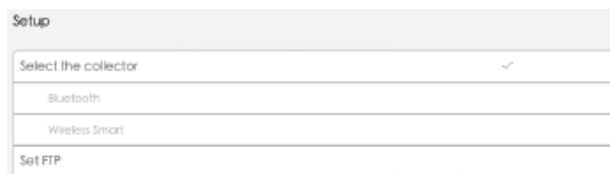

Click “Bluetooth” , enter the device scan page:

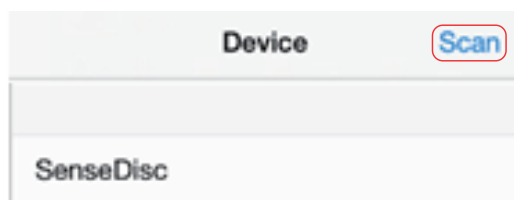

Click “scan” , then click “scan Bluetooth” :

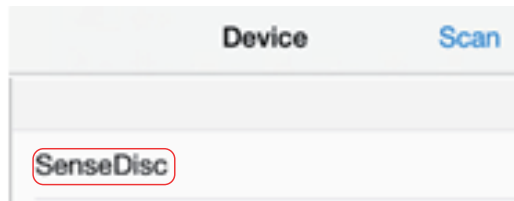

Choose “SenseDisc” , this connection will be created successfully after prompted “Successful” ;



Open  , enter into the experimental page:



Click  , enter into the experimental platform:

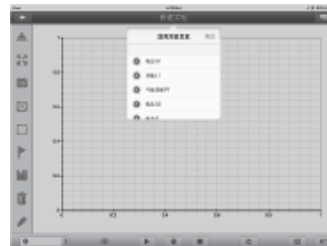

For example: current, choose “current” , click “OK” , to create the “Current–Time” coordinate system,

click  to start data acquisition:

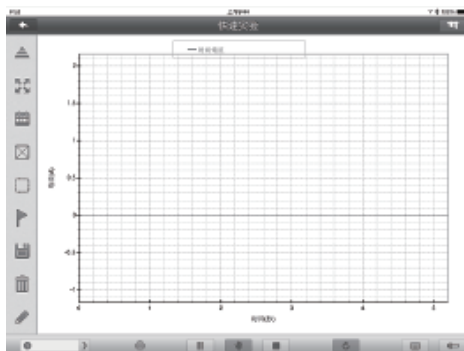

Notes

7

Clean

- If there have stains on the surface, please clean with wet towel or cloth to wipe the device;
- Do not be immersed in water or wash with detergent.

Applicable environment

The SenseDisc is apply to $-10\sim 70\text{ }^{\circ}\text{C}$ and $0\sim 95\%\text{RH}$ (Noncondensation).

Storage

- Storage in dry and shade environment with room temperature;
- When storage, make ensure the power is enough.

Attentions

- It is strictly prohibited in the long time exposure under the sun;
- It is strictly prohibited to immersion in water and any other liquid;
- Do not close to the heat source;
- Do not store it in too hot or too cold or moist environment;
- Field operation to avoid the following weather conditions: rainy, snow, hail, heavy fog, strong wind, lightning and etc.

Reset

The SenseDisc is equipped with a reset hole on its reverse side, insert a fine needle, the system will immediately reboot.



Common problems and their solutions

8

Can not work

please make sure the SenseDisc is in charging firstly; then long press the power button, or press the reset hole to reboot.

Can not connect with external devices:

- check that whether the driver is installed properly, if can not installed automatically, try to manually install: search the install position of the software, open the corresponding folder, find the folder which named "Drive" , open it, find "Setup.exe" , open it, click "install";
- When wireless connection, please check the Bluetooth setting of SenseDisc and external device are turned on.

Configure Table of Sensor Modules

9

No./Series	Basic SD0010	Advance SD0020	Physics SD0030	Biochem SD0040	Environ SD0050
S0001 Voltage	✓	✓	✓		
S0002 mV		✓	✓		
S0005 Current	✓	✓	✓		
S0009 Temperature	✓	✓	✓	✓	✓
S0013 Thermocoup		✓		✓	
S0014 Force		✓	✓		
S0015 Motion	✓	✓	✓		
S0016 Photogate			✓		
S0019 Light	✓	✓	✓	✓	✓
S0021 Sound Level	✓	✓	✓		✓
S0024 Heart Rate		✓	✓	✓	
S1002 pH		✓		✓	✓
S1003 Conductivity		✓		✓	
S1005 Dissolved O ₂		✓		✓	✓
S1008 Humidity		✓		✓	✓
S1024 Heart Rate	✓	✓		✓	
S1040 UV					✓

Sensor Manual

for Basic



Voltage sensor

S0001

Range: -30~30V

Accuracy: $\pm 1\%$



Resolution: 0.02V

Input impedance: $2M\Omega$



Voltage sensor is used to measure the electric potential difference at both ends of the electrical equipments or circuits, after the circuit of voltage sensor transferring the voltage it collects, then it can realize the measurement. The voltage sensor can be used in the DC circuit and low-voltage AC circuit.



Component

No.	Type	Name	Illustration
1	S0001	Voltage sensor	
2		Red crocodile clip	
3		Black crocodile clip	

Usage

- Connect the voltage sensor into any port of the SensorDisc
- Wires of red-black crocodile clip should be inserted into the positive and negative port of voltage sensor
- Red-black crocodile clips of voltage sensor are parallel connected to both ends of circuit or electrical equipment

Calibration

- Calibrate the voltage sensor before use
- Short connected the red-black crocodile clips of voltage sensor
- Open , click , choose “voltage sensor” , click “Calibration” ,then click “OK” .

Typical experiment

- Measure the voltage at both ends of small bulb
- Build a simple circuit
- Measure the electromotive force of dry battery

Case: Measure the EMF of dry battery

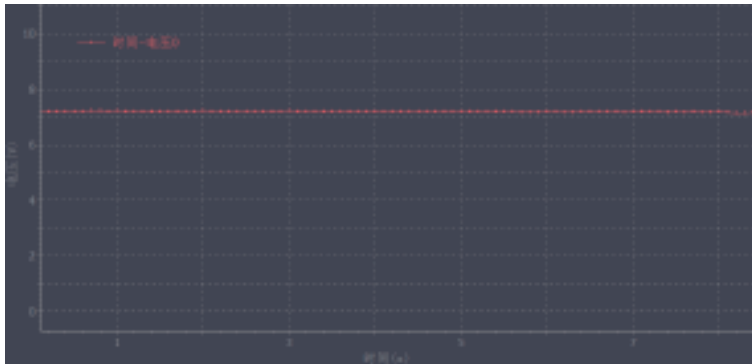

Notice:

- Voltage sensor should be parallel into the circuit when in usage
- Calibration before using voltage sensor
- Voltage sensor can not bear the voltage over 250V

Current sensor

S0005

Range: $-1\sim 1\text{A}$

Accuracy: $\pm 1\%$



Resolution: 0.001A

Internal resistance: $0.22\ \Omega$



Current sensor is used to measure the current in circuit. When current is passing the sampling resistance, it will form a tiny electric potential difference at both ends of the resistance; After enlarging the circuit, it can accurately measure the current in DC circuit or low-voltage AC.



Component

No.	Type	Name	Illustration
1	S0005	Current sensor	
2		Red crocodile clip	
3		Black crocodile clip	

Usage

- Connect the current sensor into any port of the SensorDisc
- Wires of red-black crocodile clip should be inserted into the positive and negative port of current sensor
- Red-black crocodile clips of current sensor are series connected to both ends of circuit or electrical equipment

Calibration

- Calibrate the current sensor before use
- Short connected the red-black crocodile clips of current sensor
- Open , click , choose “current sensor” , click “Calibration” ,then click “OK” .

Typical experiment

- Serial-parallel circuit of resistance
- Measure the VA characteristic curve of small bulb
- Measure the electrodynamic potential and internal resistance of battery
- Ohm's Law

Case: measure the VA characteristic curve of small bulb

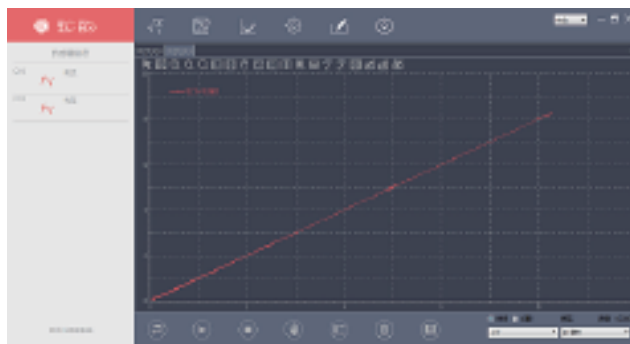

Notice:

- Serial into the circuit when using current sensor
- Calibration before using current sensor
- Current sensor can not bear the current over 3A

Temperature sensor

S0009

Range: $-40\sim 135^{\circ}\text{C}$



Accuracy: $\pm 0.6^{\circ}\text{C}$

Resolution: 0.1°C



Temperature sensor adopts the NTC electronic temperature sensing element, when the ambient temperature changes, the NTC resistance changes accordingly. Normally the temperature needs no zero calibration and with relatively higher stability; therefore, the temperature sensor is rather popular in the low-middle temperature measurements.

Component

No.	Type	Name	Illustration
1	S0009	Temperature sensor	
2		Probe	

Usage

- Connect the temperature sensor into any port of the SensorDisc
- The probe of sensor insert to the socket of temperature sensor

Typical experiment

- Measuring the temperature of the hot and cold water
- Water Cooling
- Explore the direction of heat transfer
- Explore the endothermic effects of different colors of objects
- Converging lens effect

Case: water cooling

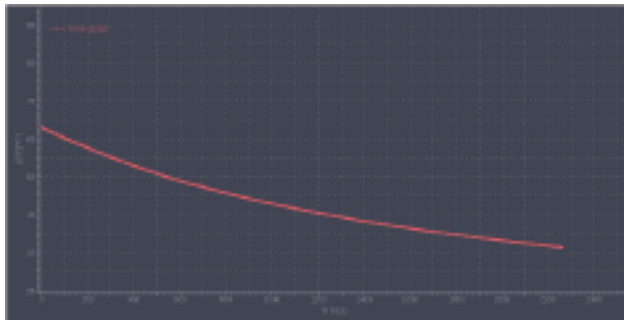

Notice:

- We can't put any part of the sensor on the open flame or heating plate directly
- When measure the temperature of liquid, should avoid the other partially of sensor immersed in liquid except stainless steel rod
- After use, cleaning sensor thoroughly
- Don't over measured range

Light sensor

S0019

Range: 0~55000Lux

Accuracy: $\pm 5\%$

Resolution: 15Lux

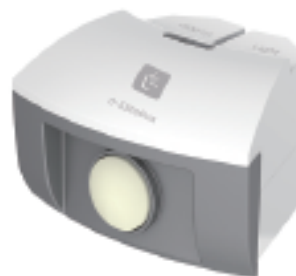

Light sensor uses the silicon photoelectric cell as the sensing element; it can convert the light intensity into a voltage signal, keeping a direct proportion. For the sensor, the effective light spectrum is in the range of 380nm to 730nm, it is an ideal intensity sensor for visible light.

Component

No.	Type	Name	Illustration
1	S0019	Light sensor	

Usage

- Connect the light sensor into any port of the SensorDisc
- The probe of light sensor is located at the front of sensor, when use, pointed the photosurface at light

Typical experiment

- Explore the effects of light intensity on photosynthesis
- Explore the relation between light intensity and distance
- Measure the light intensity of environment

Case: Measure the light intensity of environment

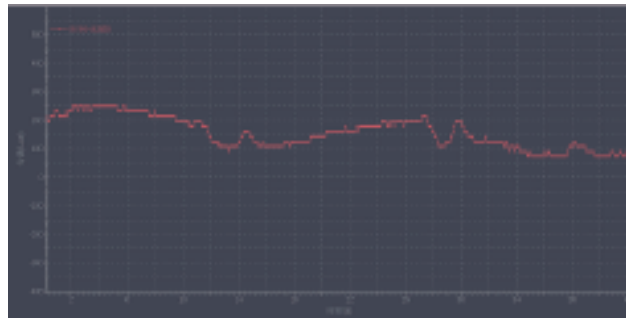

Notice:

- When use, always maintain the probe of sensor that facing light source
- Don't wear or scratch the receives of probe

Sound level sensor

S0021

Range: 40~92dB

Accuracy: ± 4 dB

Resolution: 0.1dB



Sound sensor can measure the intensity of environmental sound. Use the electret microphone collecting the sound signal, after amplifying processing, can output the value of sound intensity.

Component

No.	Type	Name	Illustration
1	S0021	Sound level sensor	

Usage

- Connect the Sound level sensor into any port of the SensorDisc
- Put the SenseDisc into the measured environment

Typical experiment

- Measure the level of sound intensity
- Measure the noise of environment

Case: Measure the noise of environment



Notice:

- Ensure that the measured sound intensity within the range. If over range, let the sensor away from the sound source or reduce the sound level
- The sensor are not waterproof, if in the humid environment, must do the protection measures to avoid the liquid into the sensor

Heart rate sensor

S1024

Range: 0–200 bpm



Resolution: ± 2 bpm

Accuracy: 1 bpm



Heart rate sensor is used to detect heart rate of human body. The probe adopts a transmissive ear clip, when in use, make the clip onto the ear lobe of the tester.

Component

No.	Type	Name	Illustration
1	S1024	Heart rate sensor	
2		Probe	

Usage

- Connect the Heart rate sensor into any port of SensorDisc
- Connect the transmissive ear clip to the sensor module
- Make the clip onto the ear lobe of the tester

Typical experiment

- Test on human heart rate

Case: Test on human heart rate

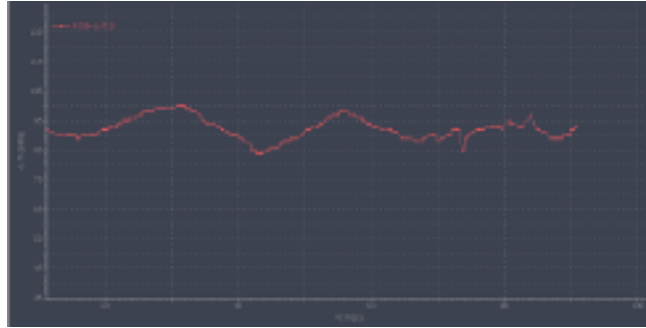

Notice:

- If the water vapor condensation in the detected environment (when is very humid), must prevent liquid invasion to the circuit part of sensor
- The response speed of humidity sensor will be faster in the flow air
- If measured environment are very dirty, you should cover the ear clip by nylon cloth to avoid pollution

Motion sensor

S0015

Range: 20~600cm

Accuracy: $\pm 2\%$

Resolution: 0.1cm



Motion sensor is a sonar equipment emitting ultrasonic pulse, it receives signal through the reflection of object, and then measure the time T when the high frequency sound wave goes around between the object and sensor; in accordance with the speed of sound in air, i.e. V, it can calculate the distance between the object and the sensor, i.e.:

$$d=V*T/2.$$

Component

No.	Type	Name	Illustration
1	S0015	Motion sensor	

Usage

- Connect the motion sensor into any port of the SensorDisc
- Pointed the ultrasonic probe at the measured object
- Measured object to be placed within the range of motion sensor

Typical experiment

- Curve of uniform linear motion and uniform variable rectilinear motion
- Simple harmonic motion
- Forced vibration

Case: explore the curve of uniform variable rectilinear motion

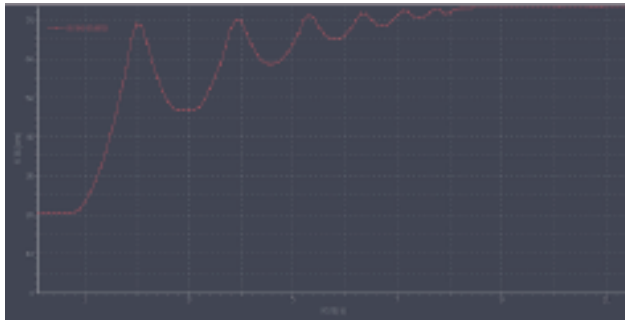

Notice:

- When use ,should pay attention to the blind area of measuring sensor
- To ensure the accuracy of measurement results, the reflection surface of measured object should be facing the probe of sensor and as large as possible
- We should pay attention: motion sensor only can sense the motion of object which nearest and produces a very strong echo

Sensor Manual

for Advance



Absolute pressure sensor

S0024



Range: 0~400kPa

Accuracy: ± 6 kPa



Absolute pressure sensor is used to measure the absolute pressure of air, it is connected with the exterior air under measurement by the front luer, whereas the luer and the sealed vacuum reference cavity inside the sensor forms a pressure difference; after the pressure difference is converted into a voltage signal, its output voltage and absolute pressure to be proportional.

Component



No.	Type	Name	Illustration
1	S0024	Absolute pressure sensor	
		Syringe	

Usage

- Connect the Absolute pressure sensor into any port of the SensorDisc
- Connect the syringe with the luer port of air pressure sensor

Calibration

Absolute pressure sensor can be used directly, if you want exact measurements, please calibrate as follows:

- Air pressure sensor – will be placed on the stable pressure environment in current
- Open , click , choose “Absolute pressure sensor”, click “Calibration”, enter a value (within range), click “OK”

Typical experiment

- Boyle's Law
- Charles' Law
- Magdeburger Halbkugeln
- The effects of Catalyst have an influence on chemical reaction rate

Case: The effects of Catalyst have an influence on chemical reaction rate

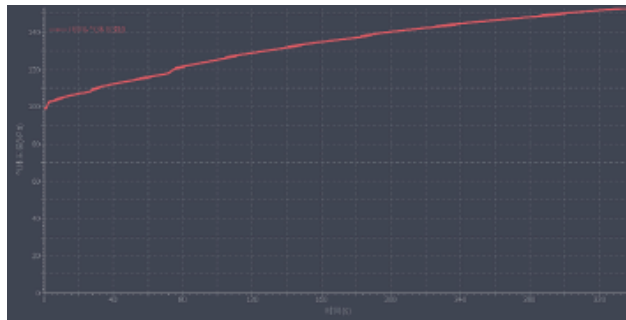

Notice:

- Absolute pressure sensor can only measure: non corrosive gases, such as air, dry gas
- The sensor is not suitable for the measurement of flammable gas
- Can be used to detect the steam pressure of liquid, but avoid the liquid enters into hose of probe
- In the pressure system, the gas in the container has a certain degree of overflow, therefore, longer research time, greater influence of gas leakage, so if conditions allow, should complete the experiment as soon as possible

Current sensor

S0005

Range: $-1\sim 1\text{A}$

Accuracy: $\pm 1\%$

Resolution: 0.001A

Internal resistance: $0.22\ \Omega$



Current sensor is used to measure the current in circuit. When current is passing the sampling resistance, it will form a tiny electric potential difference at both ends of the resistance; After enlarging the circuit, it can accurately measure the current in DC circuit or low-voltage AC.



Component

No.	Type	Name	Illustration
1	S0005	Current sensor	
2		Red crocodile clip	
3		Black crocodile clip	

Usage

- Connect the current sensor into any port of the SensorDisc
- Wires of red-black crocodile clip should be inserted into the positive and negative port of current sensor
- Red-black crocodile clips of current sensor are series connected to both ends of circuit or electrical equipment

Calibration

- Calibrate the current sensor before use
- Short connected the red-black crocodile clips of current sensor
- Open , click , choose “current sensor” , click “Calibration” ,then click “OK” .

Typical experiment

- Serial-parallel circuit of resistance
- Measure the VA characteristic curve of small bulb
- Measure the electrodynamic potential and internal resistance of battery
- Ohm's Law

Case: measure the VA characteristic curve of small bulb

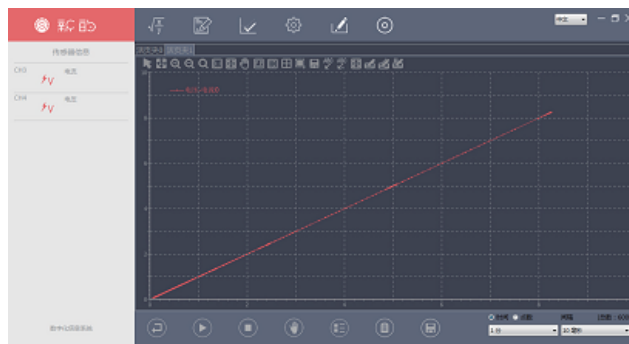

Notice:

- Serial into the circuit when using current sensor
- Calibration before using current sensor
- Current sensor can not bear the current over 3A

Light sensor

S0019

Range: 0~55000Lux

Accuracy: $\pm 5\%$

Resolution: 15Lux



Light sensor uses the silicon photoelectric cell as the sensing element; it can convert the light intensity into a voltage signal, keeping a direct proportion. For the sensor, the effective light spectrum is in the range of 380nm to 730nm, it is an ideal intensity sensor for visible light.

Component

No.	Type	Name	Illustration
1	S0019	Light sensor	

Usage

- Connect the light sensor into any port of the SensorDisc
- The probe of light sensor is located at the front of sensor, when use, pointed the photosurface at light

Typical experiment

- Explore the effects of light intensity on photosynthesis
- Explore the relation between light intensity and distance
- Measure the light intensity of environment

Case: Measure the light intensity of environment

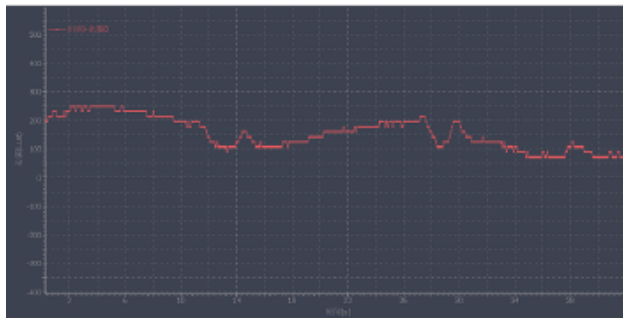

Notice:

- When use, always maintain the probe of sensor that facing light source
- Don't wear or scratch the receives of probe

pH sensor

S1002

Range: 0~14

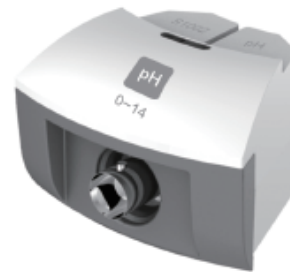

Accuracy: ± 0.2

Resolution: 0.01



The pH electrode composes of an internal reference electrode and an glass electrode. It is mainly used to measure the hydrogen ion concentration of a solution and show the pH value of the solution.

Component

No.	Type	Name	Illustration
1	S1002	pH sensor	
		Electrode probe	

Usage

- Connect the pH sensor into any port of the SensorDisc
- Tighten the port of electrode probe with sensor
- Unscrew the protective bottle of electrode probe
- Immerse the electrode probe of pH sensor into the solution completely

Calibration

Calibrate before use, before Calibration, prepare two kinds of buffer solution with known pH value, e.g. pH4.00 andf pH9.18. The calibration process, please refer to “Notes”

Typical experiment

- Acid–base neutralization titration
- pH value of different solutions
- Acidity of phenol
- The mechanism of organism that maintain pH stability
- Study on impact of pH value on pectinase activity



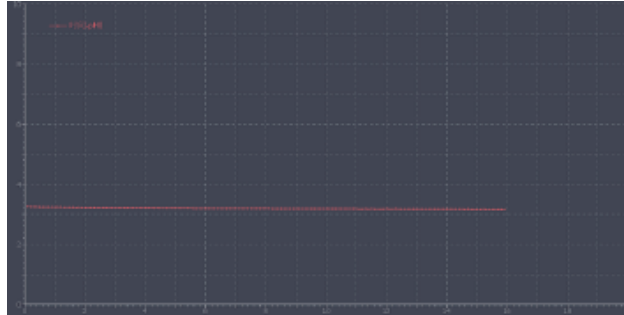



Case: Measure the pH value of orange juice

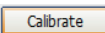

Notice:

- Rinse the electrodes before each measurement, do not use absorbent paper to wipe the glass ball of electrode, this may lead the electrode does not work, you'd better rinse the electrodes by measured solution
- In order to keep the exchange process of electrode ion occurred, the glass ball should be stored in the saturated KCl solution, If the electrode was drying, immersed in saturated KCl solution for 24 hours, make it back to the common state.
- Don't storage the electrodes in distilled water or deionized water, this will lead saturated solution around the electrode moving
- Avoid use in the extreme acid solution or extreme temperature value

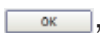
Calibration pH sensor:

- Open  , click  , choose “pH sensor” , click “Calibration” ;
- The electrode is rinsed with distilled water, and wipe with an absorbent paper, sock it in pH4.0 calibration fluid, when the value(on the left–lower corner) is stability, click  (at the back of the );
- High–end value calibration by pH9.18 calibration fluid, repeat the previous step;
- Remove electrodes, rinse the electrodes with distilled water and wipe with an absorbent paper;
- Click  , click  in the dialog

Note: pH calibration fluid (pH buffer), can use the solution by known pH value, or self configuration, or buy it in the chemical reagents store

Temperature sensor

S0009

Range: $-40\sim 135^{\circ}\text{C}$



Accuracy: $\pm 0.6^{\circ}\text{C}$

Resolution: 0.1°C



Temperature sensor adopts the NTC electronic temperature sensing element, when the ambient temperature changes, the NTC resistance changes accordingly. Normally the temperature needs no zero calibration and with relatively higher stability; therefore, the temperature sensor is rather popular in the low-middle temperature measurements.

Component

No.	Type	Name	Illustration
1	S0009	Temperature sensor	
2		Probe	

Usage

- Connect the temperature sensor into any port of the SensorDisc
- The probe of sensor insert to the socket of temperature sensor

Typical experiment

- Water cooling
- Liquid's evaporation cooling
- Energy conversion
- The relation between boiling point of liquid and air pressure
- Measure the heat of acid–base neutralization reaction
- Compare the heat conductivity of different materials
- The germination of seed

Case: water cooling

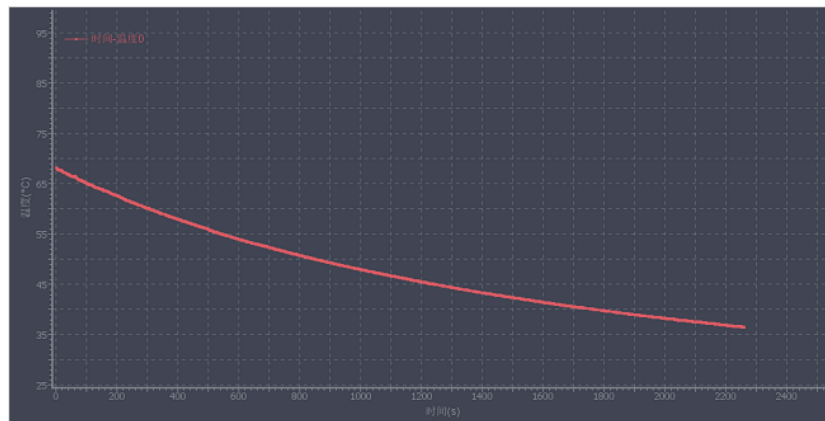

Notice:

- We can't put any part of the sensor on the open flame or heating plate directly
- When measure the temperature of liquid, should avoid the other partially of sensor immersed in liquid except stainless steel rod
- After use, cleaning sensor thoroughly
Don't over measured range

Relative humidity sensor

S1008

Range: 0~100%



Accuracy: $\pm 4\%$ (10%~90%RH)

Resolution: 0.1%



The relative humidity sensor is designed based on the sensitive humidity prototype, namely a polymer capacitance, and its capacitance will vary with the environmental humidity. The humidity sensor is designed to monitor the relative humidity of air.

Component

No.	Type	Name	Illustration
1	S1008	Relative humidity sensor	
2		Probe	

Usage

- Connect the relative humidity sensor into any port of the SensorDisc
- Insert the probe of sensor into the socket of relative humidity sensor

Typical experiment

- Measurement on the change of environmental humidity
- Hygroscopicity of concentrated sulfuric acid
- Design and make an ecological cylinder and observe its stability
- Transpiration of plant

Case: Hygroscopicity of concentrated sulfuric acid

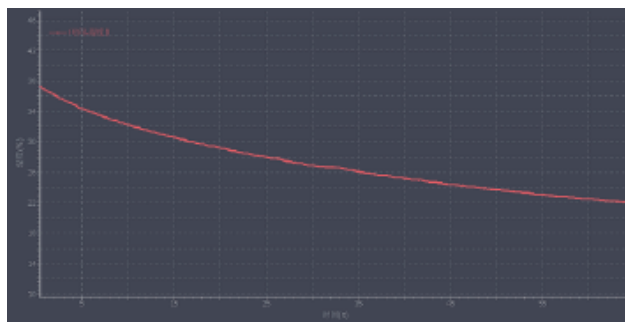

Notice:

- If the water vapor condensation in the detected environment (when is very humid), must prevent liquid invasion to the circuit part of sensor
- The response speed of humidity sensor will be faster in the flow air
- If measured environment are very dirty, you should cover sensor by nylon cloth to avoid pollution

Sound level sensor

S0021

Range: 40~92dB

Accuracy: ± 4 dB

Resolution: 0.1dB



Sound sensor can measure the intensity of environmental sound. Use the electret microphone collecting the sound signal , after amplifying processing, can output the value of sound intensity.

Component

No.	Type	Name	Illustration
1	S0021	Sound level sensor	

Usage

- Connect the Sound level sensor into any port of the SensorDisc
- Put the SenseDisc into the measured environment

Typical experiment

- Measure the level of sound intensity
- Measure the noise of environment

Case: Measure the noise of environment

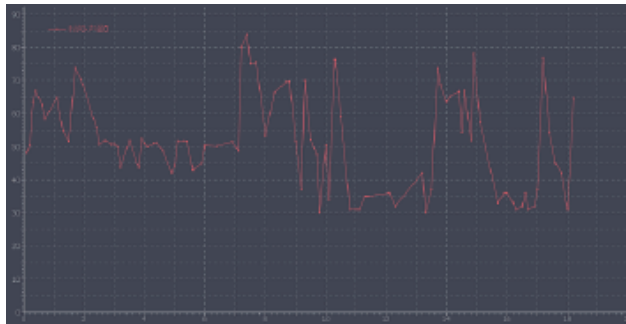

Notice:

- Ensure that the measured sound intensity within the range. If over range, let the sensor away from the sound source or reduce the sound level
- The sensor are not waterproof, if in the humid environment, must do the protection measures to avoid the liquid into the sensor

Motion sensor

S0015

Range: 20~600cm

Accuracy: $\pm 2\%$

Resolution: 0.1cm



Motion sensor is a sonar equipment emitting ultrasonic pulse, it receives signal through the reflection of object, and then measure the time T when the high frequency sound wave goes around between the object and sensor; in accordance with the speed of sound in air, i.e. V, it can calculate the distance between the object and the sensor, i.e.:

$$d=V*T/2.$$

Component

No.	Type	Name	Illustration
1	S0015	Motion sensor	

Usage

- Connect the motion sensor into any port of the SensorDisc
- Pointed the ultrasonic probe at the measured object
- Measured object to be placed within the range of motion sensor

Typical experiment

- Curve of uniform linear motion and uniform variable rectilinear motion
- Simple harmonic motion
- Forced vibration

Case: Explore the curve of uniform variable rectilinear motion

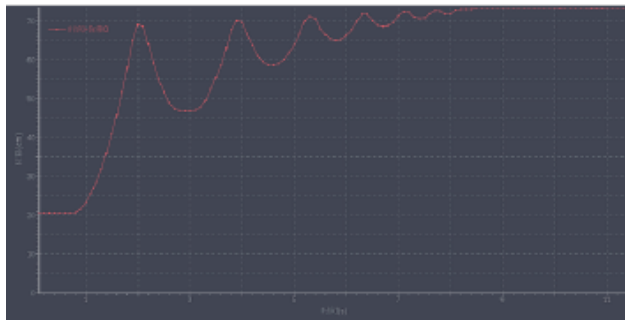

Notice:

- When use ,should pay attention to the blind area of measuring sensor
- To ensure the accuracy of measurement results, the reflection surface of measured object should be facing the probe of sensor and as large as possible
- We should pay attention: motion sensor only can sense the motion of object which nearest and produces a very strong echo

mV sensor

S0002

Range: $-500\sim 500\text{mV}$

Accuracy: $\pm 1\%$



Resolution: 0.3mV

Input impedance: $500\text{K}\Omega$



mV sensor is used to measure the electric potential difference at both ends of electric equipment or circuit. After dividing the voltage collected by the circuit of the micro voltage sensor, it can measure the mV in DC circuit or low-voltage AC circuit.



Component

No.	Type	Name	Illustration
1	S0002	mV sensor	
2		Red crocodile clip	
3		Black crocodile clip	

Usage

- Connect the mV sensor into any port of the SensorDisc
- Wires of red-black crocodile clip should be inserted into the positive and negative port of mV sensor
- Red-black crocodile clips of mV sensor are parallel connected to both ends of circuit or electrical equipment

Calibration

- Calibrate the mV sensor before use
- Short connected the red-black crocodile clips of mV sensor
- Open  , click  , choose “mV sensor” , click “Calibration” ,then click “OK” .

Typical experiment

- Solar power
- Primary cell
- Faraday’s law of electromagnetic induction

Case: Primary cell



Notice:

- mV sensor should be parallel into the circuit when in usage
- Calibration before using mV sensor
- mV sensor can not bear the voltage over 250V

Voltage sensor

S0001

Range: -30~30V

Accuracy: $\pm 1\%$



Resolution: 0.02V

Input impedance: $2M\Omega$



Voltage sensor is used to measure the electric potential difference at both ends of the electrical equipments or circuits, after the circuit of voltage sensor transferring the voltage it collects, then it can realize the measurement. The voltage sensor can be used in the DC circuit and low-voltage AC circuit.



Component

No.	Type	Name	Illustration
1	S0001	Voltage sensor	
2		Red crocodile clip	
3		Black crocodile clip	

Usage

- Connect the voltage sensor into any port of the SensorDisc
- Wires of red-black crocodile clip should be inserted into the positive and negative port of voltage sensor
- Red-black crocodile clips of voltage sensor are parallel connected to both ends of circuit or electrical equipment.

Calibration

- Calibrate the voltage sensor before use
- Short connected the red-black crocodile clips of voltage sensor
- Open , click , choose “voltage sensor” , click “Calibration” ,then click “OK” .

Typical experiment

- Serial-parallel circuit of resistance
- Measure the VA characteristic curve of small bulb
- Ohm's Law
- Resistance law
- Charging & discharging of capacitor
- Measurement of EMF and inner resistance of battery

Case: Ohm's Law

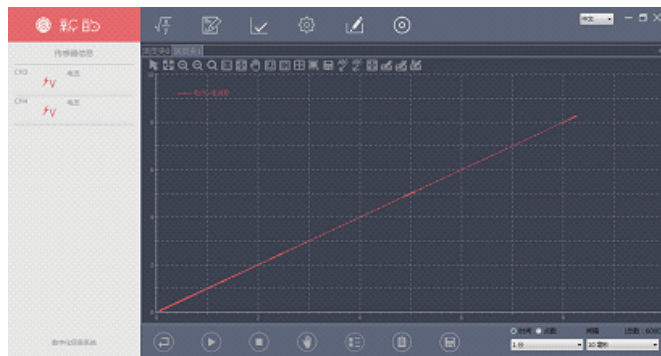

Notice:

- Voltage sensor should be parallel into the circuit when in usage
- Calibration before using voltage sensor
- Voltage sensor can not bear the voltage over 250V

Conductivity sensor

S1003

Range: 0~20000 μ s/cm



Accuracy: $\pm 4\%$

Resolution: 6 μ s/cm



The conductivity sensor is used to measure the conductivity of solution and its change. It couldn't distinguish the category of solution's ions, but can determine the total ionic concentration of solution.

Component



No.	Type	Name	Illustration
1	S1003	Conductivity sensor	
2		Electrode probe	

Usage

- Connect the conductivity sensor into any port of the SensorDisc
- Tighten the port of electrode probe with sensor
- Unscrew the protective bottle of electrode probe
- Put the electrode probe of conductivity sensor into test solution

Calibration

Conductivity sensor has been calibration in factory, the user can use it directly, if has large error, re-calibration again, calibration steps see "Notes"

- Tighten electrode probe and sensor
- Open  , click  , choose "conductivity sensor" , to Calibrate it

Typical experiment

- Comparison on the conductivity of different water
- Reaction of phenol and saturated bromine water
- Study on the purity of drinking water
- Relation between cell size and material transport

Case: Ionization of glacial acetic acid

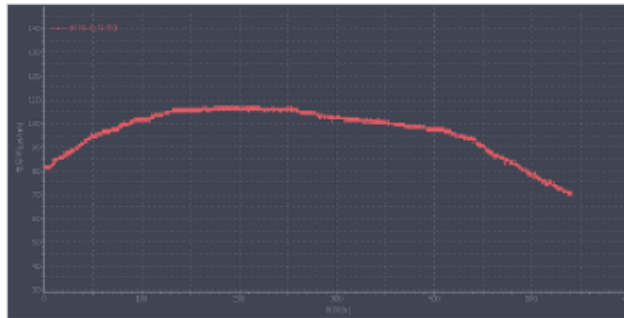

Notice:

- After experiment, clean the electrode thoroughly, to avoid pollution before next time when you are using
- Clean after usage, wipe with absorbent paper and storage. Electrode must be kept clean, prevent sediment fouling and other types of fouling

Notes

calibrate the conductivity sensor (conductivity sensor has been calibration in factory, the user can use it directly, if has large error, re-calibration again) :

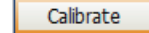
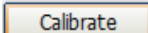
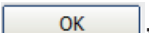
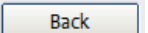
- Click , display a “Calibration” dialog, choose “conductivity sensor” ; Click 
- The electrode is rinsed with distilled water, and wipe with an absorbent paper, when the value(on the left-lower corner) is stability, click  (at the back of the **1. first value**)
- Calibrate it with known calibration fluid, enter conductivity value of known calibration fluid in **2. second value** (e.g.:1413 μ S/cm), repeat the previous step
- Remove electrodes, rinse the electrodes with distilled water and wipe with an absorbent paper
- Click , click  button

Note: the Configuration method of standard solution of conductivity, please reference 《Digital Experimental Cases of Biochemistry》

Dissolved oxygen sensor

S1005



Range: 0~20mg/L

Accuracy: $\pm 0.4\text{mg/L}$ (10~35°C)



The probe of the dissolved oxygen sensor works as per the polarogram measurement principle. The probe electrode composes of the anode, cathode and membrane. When is usage, immerse the electrode into the solution and apply the electric potential between the anode and the cathode to generate the electrochemical reaction;
Dissolved oxygen sensor also can be used for measuring oxygen content in gas.

Component

No.	Type	Name	Illustration
1	S1005	Dissolved oxygen sensor	
2		Probe	

Usage

- Connect the dissolved oxygen sensor into any port of the SensorDisc
- Tighten the port of electrode probe and sensor
- The probe placed in the test solution or gas environment to measure

Typical experiment

- Study the breathing way of saccharomycetes
- Study the dissolved oxygen of different water
- Factors that effect plant photosynthesis

Case: study the breathing way of saccharomycetes

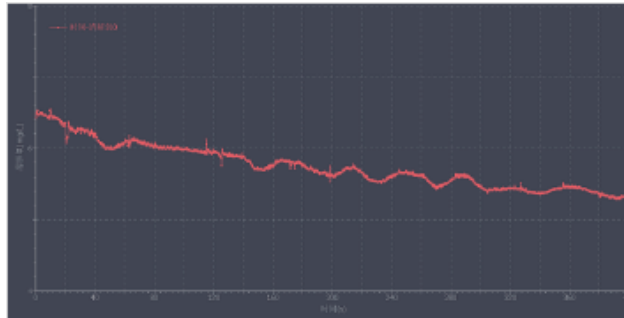

Notice:

- Avoid contact with oil or other organic matter
- If there have scale on electrode, immerse it in the 10% hydrochloric acid solution for 3 minutes, then rinse by clean water; If stained with organics, immerse it in the 8% alcohol solution for 10 minutes, then rinse by clean water;

Heart rate sensor

S1024

Range: 0–200bpm



Accuracy: 1bpm

Resolution: ± 2 bpm



Heart rate sensor is used to detect heart rate of human body. The probe adopts a transmissive ear clip, when in use, make the clip onto the ear lobe of the tester.

Component

No.	Type	Name	Illustration
1	S1024	Heart rate sensor	
2		Probe	

Usage

- Connect the Heart rate sensor into any port of SensorDisc
- Connect the transmissive ear clip to the sensor module
- Make the clip onto the ear lobe of the tester

Typical experiment

- Test on human heart rate

Case: Test on human heart rate

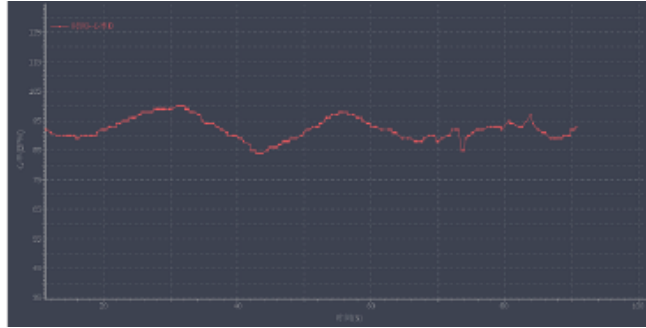

Notice:

- If the water vapor condensation in the detected environment (when is very humid), must prevent liquid invasion to the circuit part of sensor
- The response speed of humidity sensor will be faster in the flow air
- If measured environment are very dirty, you should cover the ear clip by nylon cloth to avoid pollution

Thermocouple sensor

S0013

Range: -200 to 1200°C

Accuracy: $\pm 6^{\circ}\text{C}$ (-200 – 0°C)

$\pm 3^{\circ}\text{C}$ (0 – 200°C)



$\pm 6^{\circ}\text{C}$ (200 – 1200°C)

Resolution: 0.25°C



The thermocouple sensor can be used to measure higher temperature. In the physical and chemical experiment in middle school, it can measure the temperature of flame directly, there is no need to worry about whether the cable could be damaged by high temperature.

Component

No.	Type	Name	Illustration
1	S0013	Thermocouple sensor	
2		Probe	

Usage

- Connect the thermocouple sensor into any port of the SensorDisc
- Connect the probe to the socket of thermocouple sensor

Typical experiment

- Measurement of acid–base reaction heat
- The hot water cooling
- Explore the temperature changes when a solid melts
- Explore different parts of the alcohol lamp flame temperature

Case: Explore the temperature changes when a solid melts

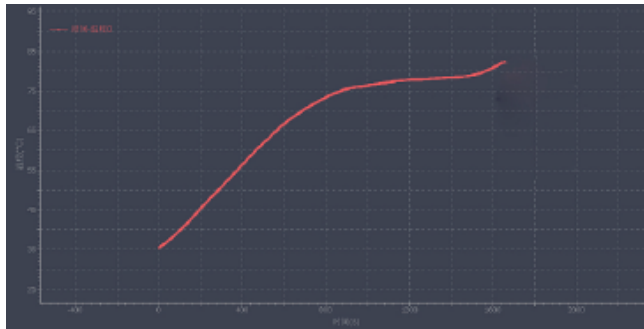

Notice:

- When in use, do not exceed the sensor's measuring range
- Probe can be immersed in corrosive liquids or object for measurement,
- but remember to wipe the probe after testing, and keep it dry for storage

Force sensor

S0014

Range: $-50\sim 50\text{N}$



Accuracy: $\pm 1\%$

Resolution: 0.03N



Force sensor has adopted a resistance strain member to convert the force into the voltage message. After circuit amplification and processing the voltage message, we can measure the force value accurately.

Component

No.	Type	Name	Illustration
1	S3000	Universal port	
2	S0014	Force sensor	
3		Trilobular screw	

Usage



- Connect the Force sensor with universal port, then Connect the Universal port into any port of the SensorDisc
- The Force sensor can be measured the tension and pressure simultaneously, pushing the metal hook, display the positive value, pulling the metal hook, display the negative value

Calibration

Calibrate the Force sensor before use

Firstly, tighten and fixed the hook of force sensor

Measuring what state forces that placed the force sensor at what state (such as measuring the horizontal force, placed the Force sensor at horizontal)

Open  , click  , choose “Force sensor” , click “Calibration” , then click “OK”

Typical experiment

- Hooke's Law
- Relationship between action and reaction force
- Overweight and weightlessness
- Simple harmonic motion
- Law of buoyancy

Case: Relationship between action and reaction force



Notice:

- Calibrate the Force sensor before use
- Should pay attention that the force direction of sensor and the sensor to be vertical in the measurement process , otherwise it will infect the results of the measurement
- Don't over measured range, otherwise, irreparable damage to Force sensor
- Hook of force sensor not tighten too much, otherwise it will infect the results of the measurement

Sensor Manual

for Physics



Absolute pressure sensor

S0024



Range: 0~400kPa

Accuracy: ± 6 kPa



Absolute pressure sensor is used to measure the absolute pressure of air, it is connected with the exterior air under measurement by the front luer, whereas the luer and the sealed vacuum reference cavity inside the sensor forms a pressure difference; after the pressure difference is converted into a voltage signal, its output voltage and absolute pressure to be proportional.

Component



No.	Type	Name	Illustration
1	S0024	Absolute pressure sensor	
		Syringe	

Usage

- Connect the Absolute pressure sensor into any port of the SensorDisc
- Connect the syringe with the luer port of air pressure sensor

Calibration

Absolute pressure sensor can be used directly, if you want exact measurements, please calibrate as follows:

- Absolute pressure sensor – will be placed on the stable pressure environment in current
- Open , click , choose “Absolute pressure sensor”, click “Calibration”, enter a value (within range), click “OK”

Typical experiment

- Boyle's Law
- Charles' Law
- Magdeburger Halbkugeln

Case: Boyle's Law

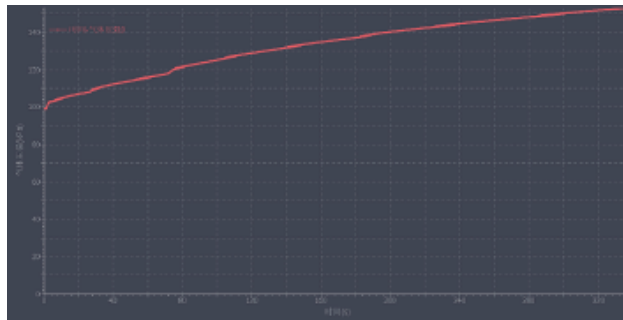

Notice:

- Absolute pressure sensor can only measure: non corrosive gases, such as air, dry gas
- The sensor is not suitable for the measurement of flammable gas
- Can be used to detect the steam pressure of liquid, but avoid the liquid enters into hose of probe
- In the pressure system, the gas in the container has a certain degree of overflow, therefore, longer research time, greater influence of gas leakage, so if conditions allow, should complete the experiment as soon as possible

Voltage sensor

S0001

Range: -30~30V

Accuracy: $\pm 1\%$



Resolution: 0.02V

Input impedance: $2M\Omega$



Voltage sensor is used to measure the electric potential difference at both ends of the electrical equipments or circuits, after the circuit of voltage sensor transferring the voltage it collects, then it can realize the measurement. The voltage sensor can be used in the DC circuit and low-voltage AC circuit.

Component

No.	Type	Name	Illustration
1	S0001	Voltage sensor	
2		Red crocodile clip	
3		Black crocodile clip	

Usage

- Connect the voltage sensor into any port of the SensorDisc
- Wires of red-black crocodile clip should be inserted into the positive and negative port of voltage sensor
- Red-black crocodile clips of voltage sensor are parallel connected to both ends of circuit or electrical equipment.

Calibration

- Calibrate the voltage sensor before use
- Short connected the red-black crocodile clips of voltage sensor
- Open , click , choose “voltage sensor” , click “Calibration” ,then click “OK” .

Typical experiment

- Serial-parallel circuit of resistance
- Measure the VA characteristic curve of small bulb
- LC oscillation
- Ohm's Law

Case: Ohm's Law

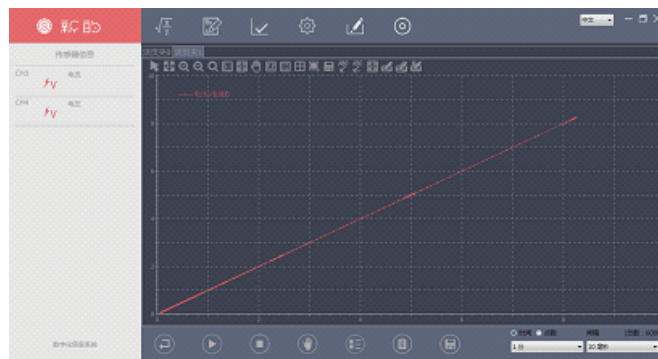

Notice:

- Voltage sensor should be parallel into the circuit when in usage
- Calibration before using voltage sensor
- Voltage sensor can not bear the voltage over 250V

Light sensor

S0019

Range: 0~55000Lux

Accuracy: $\pm 5\%$

Resolution: 15Lux



Light sensor uses the silicon photoelectric cell as the sensing element; it can convert the light intensity into a voltage signal, keeping a direct proportion. For the sensor, the effective light spectrum is in the range of 380nm to 730nm, it is an ideal intensity sensor for visible light.

Component

No.	Type	Name	Illustration
1	S0019	Light sensor	

Usage

- Connect the light sensor into any port of the SensorDisc
- The probe of light sensor is located at the front of sensor, when use, pointed the photosurface at light

Typical experiment

- Explore the relation between light intensity and distance
- Measure the light intensity of environment

Case: Explore the relation between illumination intensity and distance

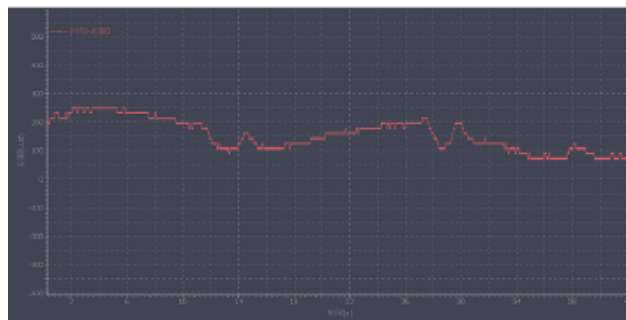

Notice:

- When use, always maintain the probe of sensor that facing light source
- Don't wear or scratch the receives of probe

Temperature sensor

S0009

Range: $-40\sim 135^{\circ}\text{C}$



Accuracy: $\pm 0.6^{\circ}\text{C}$

Resolution: 0.1°C



Temperature sensor adopts the NTC electronic temperature sensing element, when the ambient temperature changes, the NTC resistance changes accordingly. Normally the temperature needs no zero calibration and with relatively higher stability; therefore, the temperature sensor is rather popular in the low-middle temperature measurements.

Component

No.	Type	Name	Illustration
1	S0009	Temperature sensor	
2		Probe	

Usage

- Connect the temperature sensor into any port of the SensorDisc
- Insert the probe of sensor into the socket of temperature sensor

Typical experiment

- Water cooling
- Water freezes and ice melt
- Energy conversion
- The relation between boiling point of liquid and air pressure
- Compare the heat conductivity of different material

Case: Water cooling

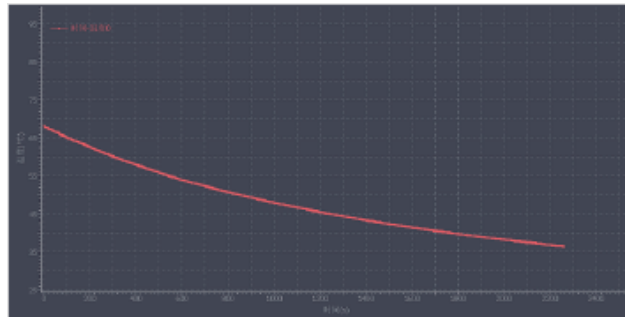

Notice:

- We can't put any part of the sensor on the open flame or heating plate directly
- When measure the temperature of liquid, should avoid the other partially of sensor immersed in liquid except stainless steel rod
- After use, cleaning sensor thoroughly
- Don't over measured range

Current sensor

S0005

Range: $-1\sim 1\text{A}$

Accuracy: $\pm 1\%$



Resolution: 0.001A

Internal resistance: $0.22\ \Omega$



Current sensor is used to measure the current in circuit. When current is passing the sampling resistance, it will form a tiny electric potential difference at both ends of the resistance; After enlarging the circuit, it can accurately measure the current in DC circuit or low-voltage AC.



Component

No.	Type	Name	Illustration
1	S0005	Current sensor	
2		Red crocodile clip	
3		Black crocodile clip	

Usage

- Connect the current sensor into any port of the SensorDisc
- Wires of red-black crocodile clip should be inserted into the positive and negative port of current sensor
- Red-black crocodile clips of current sensor are series connected to both ends of circuit or electrical equipment.

Calibration

- Calibrate the current sensor before use
- Short connected the red-black crocodile clips of current sensor
- Open  , click  , choose “current sensor” , click “Calibration” ,then click “OK” .

Typical experiment

- Serial-parallel circuit of resistance
- Measure the VA characteristic curve of small bulb
- Measure the electrodynamic potential and internal resistance of battery
- Ohm's Law

Case: Measure the VA characteristic curve of small bulb

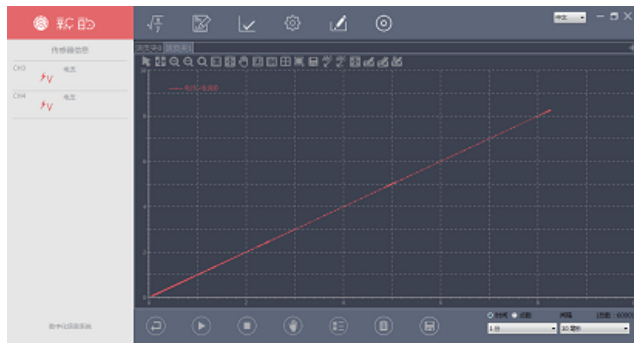

Notice:

- Serial into the circuit when using current sensor
- Calibration before using current sensor
- Current sensor can not bear the current over 3A

Sound level sensor

S0021

Range: 40~92dB

Accuracy: ± 4 dB

Resolution: 0.1dB



Sound sensor can measure the intensity of environmental sound. Use the electret microphone collecting the sound signal, after amplifying processing, can output the value of sound intensity.

Component

No.	Type	Name	Illustration
1	S0021	Sound level sensor	

Usage

- Connect the Sound level sensor into any port of the SensorDisc
- Put the SenseDisc into the measured environment

Typical experiment

- Measure the level of sound intensity
- Measure the noise of environment

Case: Measure the noise of environment

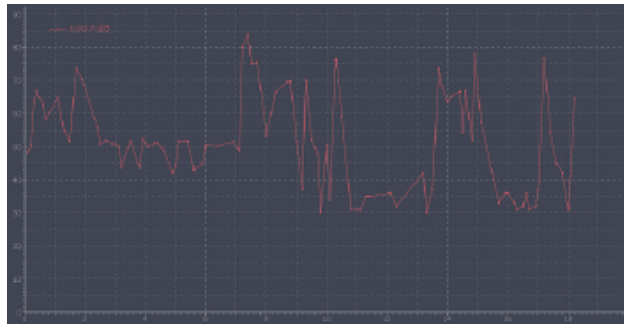

Notice:

- Ensure that the measured sound intensity within the range. If over range, let the sensor away from the sound source or reduce the sound level
- The sensor are not waterproof, if in the humid environment, must do the protection measures to avoid the liquid into the sensor

Motion sensor

S0015

Range: 20~600cm

Accuracy: $\pm 2\%$

Resolution: 0.1cm



Motion sensor is a sonar equipment emitting ultrasonic pulse, it receives signal through the reflection of object, and then measure the time T when the high frequency sound wave goes around between the object and sensor; in accordance with the speed of sound in air, i.e. V, it can calculate the distance between the object and the sensor, i.e.:

$$d=V*T/2.$$

Component

No.	Type	Name	Illustration
1	S0015	Motion sensor	

Usage

- Connect the motion sensor into any port of the SensorDisc
- Pointed the ultrasonic probe at the measured object
- Measured object to be placed within the range of motion sensor

Typical experiment

- Curve of uniform linear motion and uniform variable rectilinear motion
- Simple harmonic motion
- To explore the trajectory of the object
- The movement of bubbles
- Measure the velocity via sensor

Case: Explore the curve of uniform variable rectilinear motion

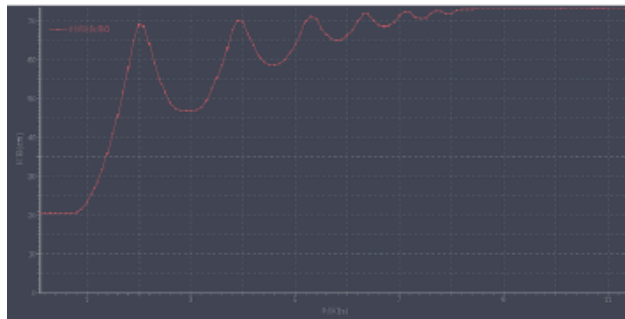

Notice:

- When use ,should pay attention to the blind area of measuring sensor
- To ensure the accuracy of measurement results, the reflection surface of measured object should be facing the probe of sensor and as large as possible
- We should pay attention: motion sensor only can sense the motion of object which nearest and produces a very strong echo

mV sensor

S0002

Range: -500~500mV

Accuracy: $\pm 1\%$



Resolution: 0.3mV

Input impedance: 500K Ω



mV sensor is used to measure the electric potential difference at both ends of electric equipment or circuit. After dividing the voltage collected by the circuit of the micro voltage sensor, it can measure the mV in DC circuit or low-voltage AC circuit.



Component

No.	Type	Name	Illustration
1	S0002	mV sensor	
2		Red crocodile clip	
3		Black crocodile clip	

Usage

- Connect the mV sensor into any port of the SensorDisc
- Wires of red-black crocodile clip should be inserted into the positive and negative port of mV sensor
- Red-black crocodile clips of mV sensor are parallel connected to both ends of circuit or electrical equipment

Calibration

- Calibrate the current sensor before use
- Short connected the red-black crocodile clips of current sensor
- Open  , click  , choose “mV sensor” , click “Calibration” ,then click “OK” .

Typical experiment

- Faraday’s law of electromagnetic induction
- Solar power
- Primary cell

Case: Primary cell

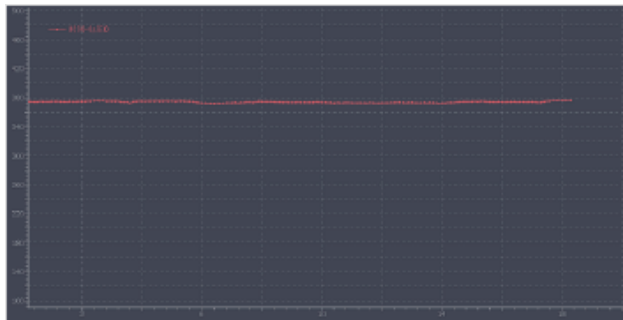

Notice:

- mV sensor should be parallel into the circuit when in usage
- Calibration before using mV sensor
- mV sensor can not bear the voltage over 250V

Force sensor

S0014

Range: $-50\sim 50\text{N}$



Accuracy: $\pm 1\%$

Resolution: 0.03N



Force sensor has adopted a resistance strain member to convert the force into the voltage message. After circuit amplification and processing the voltage message, we can measure the force value accurately.

Component

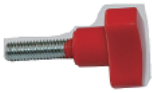
No.	Type	Name	Illustration
1	S3000	Universal port	
2	S0014	Force sensor	
3		Trilobular screw	

Usage



- Connect the Force sensor with universal port, then Connect the Universal port into any port of the SensorDisc
- The Force sensor can be measured the tension and pressure simultaneously, pushing the metal hook, display the positive value, pulling the metal hook, display the negative value

Calibration

Calibrate the Force sensor before use

Firstly, tighten and fixed the hook of force sensor

Measuring what state forces that placed the force sensor at what state (such as measuring the horizontal force, placed the Force sensor at horizontal)

Open  , click  , choose “Force sensor” , click “Calibration” , then click “OK”

Typical experiment

- Hooke's Law
- Relation between action and reaction force
- Overweight and weightlessness
- Simple harmonic motion
- Law of buoyancy

Case: Relation between action and reaction force

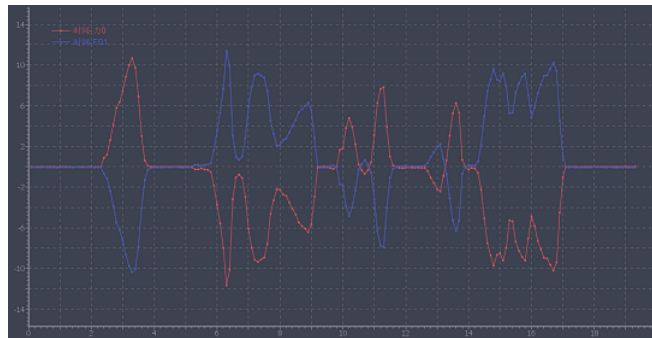

Notice:

- Calibrate the Force sensor before use
- Should pay attention that the force direction of sensor and the sensor to be vertical in the measurement process , otherwise it will infect the results of the measurement
- Don't over measured range, otherwise, irreparable damage to Force sensor
- Hook of force sensor not tighten too much, otherwise it will infect the results of the measurement

Photogate

S0016

Range: $0 \sim \infty$ s



Accuracy: $\pm 1 \mu\text{s}$

Resolution: $1 \mu\text{s}$





In essence, the photogate sensor is a digital-switch sensor, with the infrared emitter and infrared receiver at both ends respectively. If the infrared receiver receives the light beam, the photogate sensor will be in low-voltage (on-state); if the infrared beam is blocked off, and the infrared receiver fails to receive the beam, the photogate sensor will be in high-voltage (off-state).

Component

No.	Type	Name	Illustration
1	S3000	Universal port	
2	S0016	Photogate	
3		Trilobular screw	

Usage

- Connect the photogate sensor with universal port, then Connect the Universal port into any port of the SensorDisc
- When use photogate sensor, according to the experimental type and accessories, we can set it as follows:
open , click , choose experimental type、type of light barrier, then choose measured physical quantity, input related parameters, click “OK” (because different set in different experiment, detailed settings please refer to the 《SenseDisc All-in-one Experimental Cases》)

Typical experiment

- Explore the relationship among force, mass and acceleration
- Simple pendulum
- Theorem of momentum
- Mechanical Energy Conservation Law
- Freely-falling body motion

Case: Freely-falling body motion



Notice:

- Calibrate the photogate sensor before usage
- Installation of photogate sensor is varied, should according to the specific experimental flexibly assembled, pay attention that accurate positioning and firm connection in the assembly process
- The photogate is very sensitive to the high intensity infrared and heat of surrounding environment, should avoid bright light. Because the glare, will produce an error closed results

Sensor Manual

for Biochemistry



Absolute pressure sensor

S0024



Range: 0~400kPa

Accuracy: $\pm 6\text{kPa}$



Absolute pressure sensor is used to measure the absolute pressure of air, it is connected with the exterior air under measurement by the front luer, whereas the luer and the sealed vacuum reference cavity inside the sensor forms a pressure difference; after the pressure difference is converted into a voltage signal, its output voltage and absolute pressure to be proportional.

Component

No.	Type	Name	Illustration
1	S0024	Absolute pressure sensor	
		Syringe	

Usage

- Connect the Absolute pressure sensor into any port of the SensorDisc

Calibration

Absolute pressure sensor can be used directly, if you want exact measurements, please calibrate as follows:

- Absolute pressure sensor – will be placed on the stable pressure environment in current
- Open , click , choose “Absolute pressure sensor” , click “Calibration” , enter a value (within range) , click “OK”

Typical experiment

- Boyle's Law
- Charles' Law
- Magdeburger Halbkugeln
- The effects of Catalyst have an influence on chemical reaction rate

Case: The effects of Catalyst have an influence on chemical reaction rate

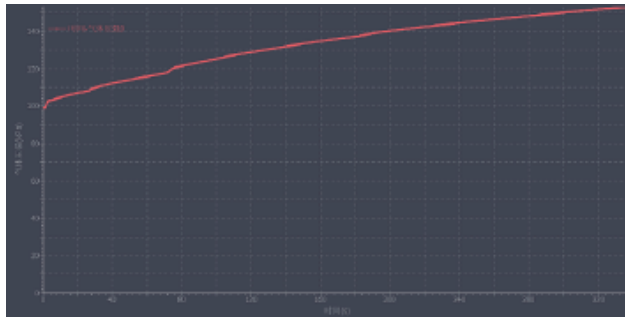

Notice:

- Absolute pressure sensor can only measure: non corrosive gases, such as air, dry gas
- The sensor is not suitable for the measurement of flammable gas
- Can be used to detect the steam pressure of liquid, but avoid the liquid enters into hose of probe
- In the pressure system, the gas in the container has a certain degree of overflow, therefore, longer research time, greater influence of gas leakage, so if conditions allow, should complete the experiment as soon as possible

Conductivity sensor

S1003

Range: 0~20000 μ s/cm



Accuracy: $\pm 4\%$

Resolution: 6 μ s/cm



The conductivity sensor is used to measure the conductivity of solution and its change. It couldn't distinguish the category of solution's ions, but can determine the total ionic concentration of solution.

Component

No.	Type	Name	Illustration
1	S1003	Conductivity sensor	
2		Electrode probe	

Usage

- Connect the conductivity sensor into any port of the SensorDisc
- Tighten the port of electrode probe and sensor
- Unscrew the protective bottle of electrode probe
- Put the electrode probe of conductivity sensor into test solution

Calibration

Conductivity sensor has been calibration in factory, the user can use it directly, if has large error, re-calibration again, calibration steps see "Notes"

- Tighten electrode probe and sensor
- Open  , click  , choose "conductivity sensor" , to Calibrate

Typical experiment

- Comparison on the conductivity of different water
- Reaction of phenol and saturated bromine water
- Study on the purity of drinking water
- Relation between cell size and material transport

Case: Ionization of glacial acetic acid

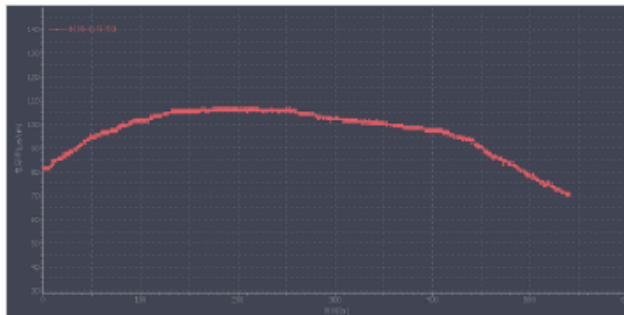



Notice:

- After experiment, clean the electrode thoroughly, to avoid pollution before next time when you are using
- Clean after usage, wipe with absorbent paper and storage. Electrode must be kept clean, prevent sediment fouling and other types of fouling

Notes

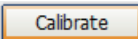
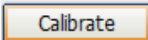
calibrate the conductivity sensor (conductivity sensor has been calibration in factory, the user can use it directly, if has large error, re-calibration again) :

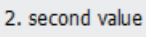
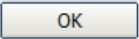
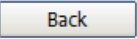
- Click , display a “Calibration” dialog, choose “conductivity sensor” ; Click 
- The electrode is rinsed with distilled water, and wipe with an absorbent paper, when the value(on the left-lower corner) is stability, click  (at the back of the )
- Calibrate it with known calibration fluid, enter conductivity value of known calibration fluid in  (e.g.:1413 μ S/cm), repeat the previous step
- Remove electrodes, rinse the electrodes with distilled water and wipe with an absorbent paper
- Click , click  button

Note: the Configuration method of standard solution of conductivity, please reference 《Digital Experimental Cases of Biochemistry》

Light sensor

S0019

Range: 0~55000Lux

Accuracy: $\pm 5\%$

Resolution: 15Lux



Light sensor uses the silicon photoelectric cell as the sensing element; it can convert the light intensity into a voltage signal, keeping a direct proportion. For the sensor, the effective light spectrum is in the range of 380nm to 730nm, it is an ideal intensity sensor for visible light.

Component

No.	Type	Name	Illustration
1	S0019	Light sensor	

Usage

- Connect the light sensor into any port of the SensorDisc
- The probe of light sensor is located at the front of sensor, when use, pointed the photosurface at light

Typical experiment

- Explore the effects of light intensity on photosynthesis
- Measure the light intensity of environment

Case: Measure the light intensity of environment

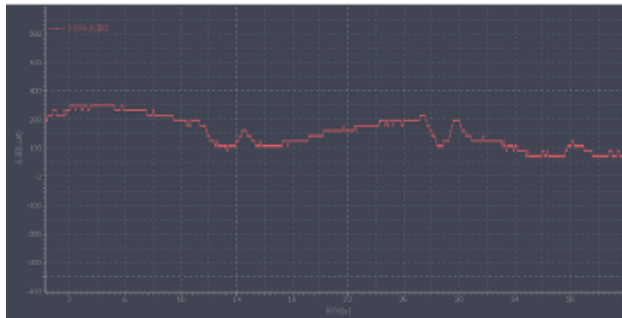

Notice:

- When use, always maintain the probe of sensor that facing light source
- Don't wear or scratch the receives of probe

Thermocouple sensor

S0013

Range: -200 to 1200°C

Accuracy: $\pm 6^{\circ}\text{C}$ (-200 – 0°C)

$\pm 3^{\circ}\text{C}$ (0 – 200°C)



$\pm 6^{\circ}\text{C}$ (200 – 1200°C)

Resolution: 0.25°C



The thermocouple sensor can be used to measure higher temperature. In the physical and chemical experiment in middle school, it can measure the temperature of flame directly, there is no need to worry about whether the cable could be damaged by high temperature.

Component

No.	Type	Name	Illustration
1	S0013	Thermocouple sensor	
2		Probe	

Usage

- Connect the thermocouple sensor into any port of the SensorDisc
- Connect the probe to the socket of thermocouple sensor

Typical experiment

- The hot water cooling
- Explore different parts of the alcohol lamp flame temperature

Case: The hot water cooling

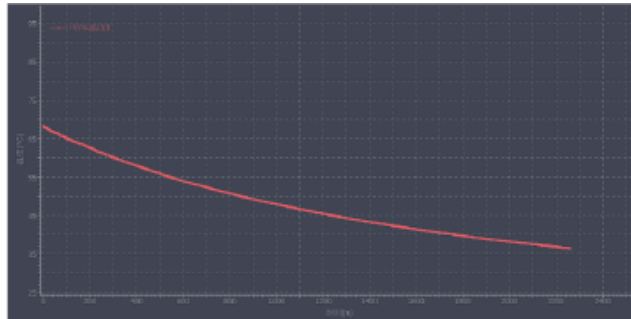

Notice:

- When in use, do not exceed the sensor's measuring range
- Probe can be immersed in corrosive liquids or object for measurement,
- but remember to wipe the probe after testing, and keep it dry for storage

Heart rate sensor

S1024

Range: 0–200bpm



Accuracy: 1bpm

Resolution: ± 2 bpm



Heart rate sensor is used to detect heart rate of human body. The probe adopts a transmissive ear clip, when in use, make the clip onto the ear lobe of the tester.

Component

No.	Type	Name	Illustration
1	S1024	Heart rate sensor	
2		Probe	

Usage

- Connect the Heart rate sensor into any port of SensorDisc
- Connect the transmissive ear clip to the sensor module
- Make the clip onto the ear lobe of the tester

Typical experiment

- Test on human heart rate

Case: Test on human heart rate

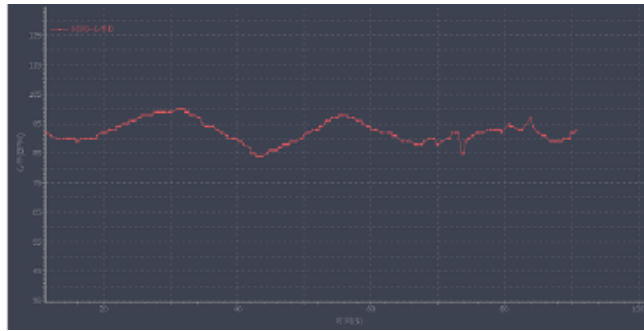

Notice:

- If the water vapor condensation in the detected environment (when is very humid), must prevent liquid invasion to the circuit part of sensor
- The response speed of humidity sensor will be faster in the flow air
- If measured environment are very dirty, you should cover the ear clip by nylon cloth to avoid pollution

Relative Humidity sensor

S1008

Range: 0~100%



Accuracy: $\pm 4\%$ (10%~90%RH)

Resolution: 0.1%



The relative humidity sensor is designed based on the sensitive humidity prototype, namely a polymer capacitance, and its capacitance will vary with the environmental humidity. The humidity sensor is designed to monitor the relative humidity of air.

Component

No.	Type	Name	Illustration
1	S1008	Relative humidity sensor	
2		Probe	

Usage

- Connect the relative humidity sensor into any port of the SensorDisc
- The probe of sensor insert to the socket of relative humidity sensor

Typical experiment

- Measurement on the change of environmental humidity
- Design and make an ecological cylinder and observe its stability
- Transpiration of plant

Case: Measurement on the change of environmental humidity

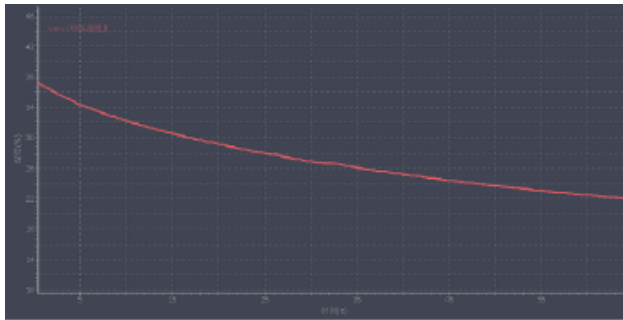

Notice:

- If the water vapor condensation in the detected environment (when is very humid), must prevent liquid invasion to the circuit part of sensor
- The response speed of humidity sensor will be faster in the flow air
- If measured environment are very dirty, you should cover sensor by nylon cloth to avoid pollution

pH sensor

S1002

Range: 0~14

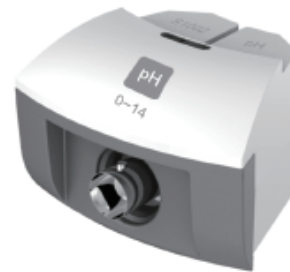

Accuracy: ± 0.2

Resolution: 0.01



The pH electrode composes of an internal reference electrode and an glass electrode. It is mainly used to measure the hydrogen ion concentration of a solution and show the pH value of the solution.

Component

No.	Type	Name	Illustration
1	S1002	pH sensor	
		Electrode probe	

Usage

- Connect the pH sensor into any port of the SensorDisc
- Tighten the port of electrode probe and sensor
- Unscrew the protective bottle of electrode probe
- The electrode probe of pH sensor immersed in the solution completely

Calibration

Calibrate before use, before Calibration, prepare two kinds of buffer solution with known pH value, e.g. pH4.00 andf pH9.18. The calibration process, please refer to “Notes”

Typical experiment

- The physical and chemical properties determination of water
- Measurement of soil acid and alkaline
- To explore reaction of carbon dioxide with clarify whitewash
- Properties difference of different concentration solutions (pH)
- Volatilization of concentrated ammonia and dissolution of ammonia

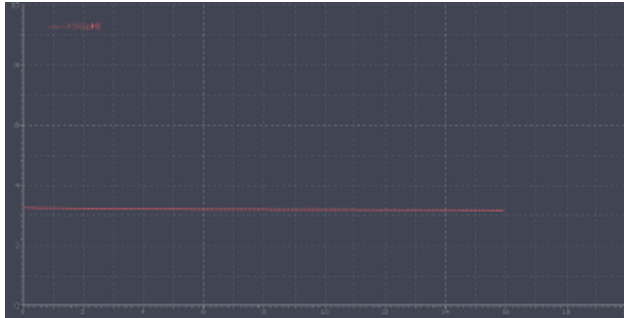

Case: Measure the pH value of orange juice



Notice:

- Rinse the electrodes before each measurement, do not use absorbent paper to wipe the glass ball of electrode, this may lead the electrode does not work, you'd better rinse the electrodes by measured solution
- In order to keep the exchange process of electrode ion occurred, the glass ball should be stored in the saturated KCl solution, If the electrode was drying, immersed in saturated KCl solution for 24 hours, make it back to the common state.
- Don't storage the electrodes in distilled water or deionized water, this will lead saturated solution around the electrode moving
- Avoid use in the extreme acid solution or extreme temperature value

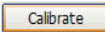
Calibration pH sensor:

- Open , click , choose “pH sensor” , click “Calibration” ;
- The electrode is rinsed with distilled water, and wipe with an absorbent paper, sock it in pH4.0 calibration fluid, when the value(on the left-lower corner) is stability, click  (at the back of the 1. first value) ;
- High-end value calibration by pH9.18 calibration fluid, repeat the previous step;
- Remove electrodes, rinse the electrodes with distilled water and wipe with an absorbent paper;
- Click , click  in the dialog

Note: pH calibration fluid (pH buffer), can use the solution by known pH value, or self configuration, or buy it in the chemical reagents store

Temperature sensor

S0009

Range: $-40\sim 135^{\circ}\text{C}$



Accuracy: $\pm 0.6^{\circ}\text{C}$

Resolution: 0.1°C



Temperature sensor adopts the NTC electronic temperature sensing element, when the ambient temperature changes, the NTC resistance changes accordingly. Normally the temperature needs no zero calibration and with relatively higher stability; therefore, the temperature sensor is rather popular in the low-middle temperature measurements.

Component

No.	Type	Name	Illustration
1	S0009	Temperature sensor	
2		Probe	

Usage

- Connect the temperature sensor into any port of the SensorDisc
- Insert the probe of sensor into the socket of relative humidity sensor

Typical experiment

- Water cooling
- Liquid's evaporation cooling
- Energy conversion
- The relation between boiling point of liquid and air pressure
- Measure the heat of acid–base neutralization reaction
- Compare the heat conductivity of different materials
- The germination of seed

Case: Water cooling

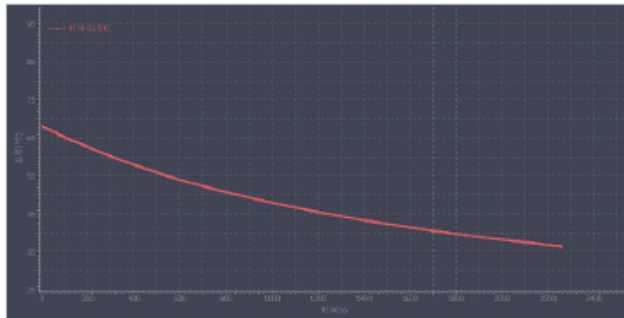

Notice:

- We can't put any part of the sensor on the open flame or heating plate directly
- When measure the temperature of liquid, should avoid the other partially of sensor immersed in liquid except stainless steel rod
- After use, cleaning sensor thoroughly
- Don't over measured range

Dissolved oxygen sensor

S1005



Range: 0~20mg/L

Accuracy: ± 0.4 mg/L (10~35°C)



The probe of the dissolved oxygen sensor works as per the polarogram measurement principle. The probe electrode composes of the anode, cathode and membrane. When is usage, immerse the electrode into the solution and apply the electric potential between the anode and the cathode to generate the electrochemical reaction; Dissolved oxygen sensor also can be used for measuring oxygen content in gas.

Component

No.	Model	Name	Illustration
1	S1005	Dissolved oxygen sensor	
2		Probe	

Usage

- Connect the dissolved oxygen sensor into any port of the SensorDisc
- Tighten the port of electrode probe and sensor
- The probe placed in the test solution or gas environment to measure

Typical experiment

- Study the breathing way of saccharomycetes
- Study the dissolved oxygen of different water
- Factors that effect plant photosynthesis

Case: study the breathing way of saccharomycetes

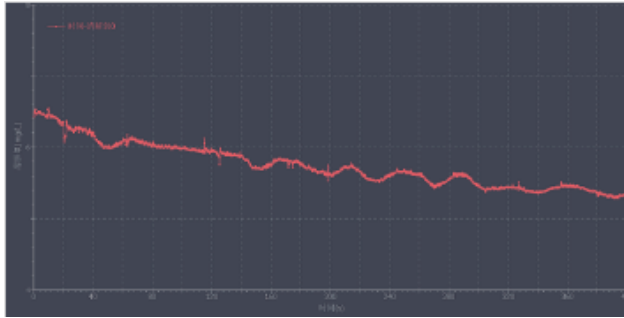

Notice:

- Avoid contact with oil or other organic matter
- If there have scale on electrode, immerse it in the 10% hydrochloric acid solution for 3 minutes, then rinse by clean water; If stained with organics, immerse it in the 8% alcohol solution for 10 minutes, then rinse by clean water;

Sensor Manual

for Environment



UV sensor

S1040

Range: 0~400 W/m²

Accuracy: ± 5%



UV sensor is an experimental device used for detecting ultraviolet strength, radiation scope during 100nm to 400nm in the electromagnetic spectrum belongs to the ultraviolet wavelength range, UV sensor can transform the received uv intensity into a proportional output voltage signal.

Component

No.	Type	Name	Illustration
1	S1040	UV sensor	

Usage

- Connect the UV sensor into any port of the SensorDisc
- Placed the sensor on the test environment

Typical experiment

- Detect ultraviolet strength in photoelectric effect
- Impact of different intensities of ultraviolet ray on biological survival rate

Case: Detect ultraviolet strength in photoelectric effect

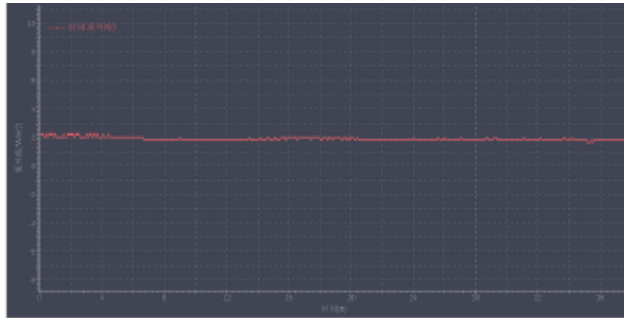

Notice:

- In experiment, the UV sensor was placed under ultraviolet irradiation , the human eyes can not touch ultraviolet light directly
- According to different experimental conditions, adjusting the acquisition time and frequency in the software

pH sensor

S1002

Range: 0~14

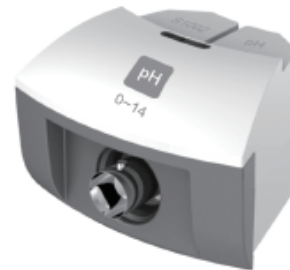

Accuracy: ± 0.2

Resolution: 0.01



The pH electrode composes of an internal reference electrode and an glass electrode. It is mainly used to measure the hydrogen ion concentration of a solution and show the pH value of the solution.

Component

No.	Type	Name	Illustration
1	S1002	pH sensor	
		Electrode probe	

Usage

- Connect the pH sensor into any port of the SensorDisc
- Tighten the port of electrode probe and sensor
- Unscrew the protective bottle of electrode probe
- The electrode probe of pH sensor immersed in the solution completely

Calibration

Calibrate before use, before Calibration, prepare two kinds of buffer solution with known pH value, e.g. pH4.00 and pH9.18. The calibration process, please refer to "Notes"

Typical experiment

- The physical and chemical properties determination of water
- Measurement of soil acid and alkaline
- To explore reaction of carbon dioxide with clarify whitewash
- Properties difference of different concentration solutions (pH)
- Volatilization of concentrated ammonia and dissolution of ammonia

Case: Measure the pH value of orange juice

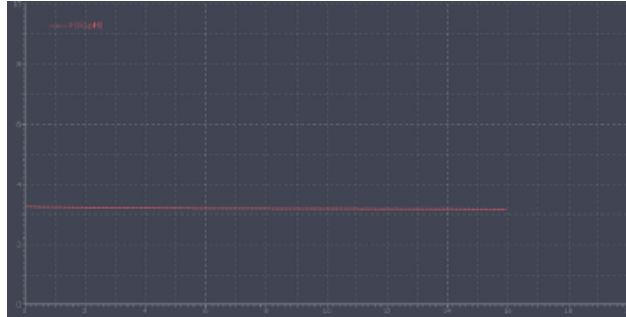

Notice:

- Rinse the electrodes before each measurement, do not use absorbent paper to wipe the glass ball of electrode, this may lead the electrode does not work, you'd better rinse the electrodes by measured solution
- In order to keep the exchange process of electrode ion occurred, the glass ball should be stored in the saturated KCl solution, If the electrode was drying, immersed in saturated KCl solution for 24 hours, make it back to the common state.
- Don't storage the electrodes in distilled water or deionized water, this will lead saturated solution around the electrode moving
- Avoid use in the extreme acid solution or extreme temperature value

Calibration pH sensor:

- Open , click , choose “pH sensor” , click “Calibration” ;
- The electrode is rinsed with distilled water, and wipe with an absorbent paper, sock it in pH4.0 calibration fluid, when the value(on the left–lower corner) is stability, click (at the back of the);
- High–end value calibration by pH9.18 calibration fluid, repeat the previous step;
- Remove electrodes, rinse the electrodes with distilled water and wipe with an absorbent paper;
- Click , click in the dialog

Note: pH calibration fluid (pH buffer), can use the solution by known pH value, or self configuration, or buy it in the chemical reagents store

Sound level sensor

S0021

Range: 40~92dB

Accuracy: ± 4 dB

Resolution: 0.1dB



Sound sensor can measure the intensity of environmental sound. Use the electret microphone collecting the sound signal , after amplifying processing, can output the value of sound intensity.

Component

No.	Type	Name	Illustration
1	S0021	Sound level sensor	

Usage

- Connect the Sound level sensor into any port of the SensorDisc
- Put the SenseDisc into the measured environment

Typical experiment

- Measure the level of sound intensity
- Measure the noise of environment

Case: Measure the noise of environment

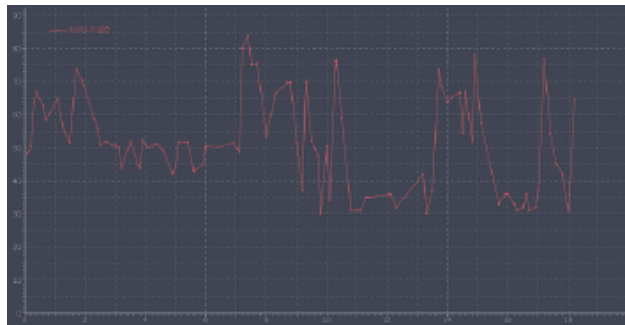

Notice:

- Ensure that the measured sound intensity within the range. If over range, let the sensor away from the sound source or reduce the sound level
- The sensor are not waterproof, if in the humid environment, must do the protection measures to avoid the liquid into the sensor

Light sensor

S0019

Range: 0~55000Lux

Accuracy: $\pm 5\%$

Resolution: 15Lux



Light sensor uses the silicon photoelectric cell as the sensing element; it can convert the light intensity into a voltage signal, keeping a direct proportion. For the sensor, the effective light spectrum is in the range of 380nm to 730nm, it is an ideal intensity sensor for visible light.

Component

No.	Type	Name	Illustration
1	S0019	Light sensor	

Usage

- Connect the light sensor into any port of the SensorDisc
- The probe of light sensor is located at the front of sensor, when use, pointed the photosurface at light

Typical experiment

- Explore the effects of light intensity on photosynthesis
- Explore the relation between light intensity and distance
- Measure the light intensity of environment

Case: Measure the light intensity of environment

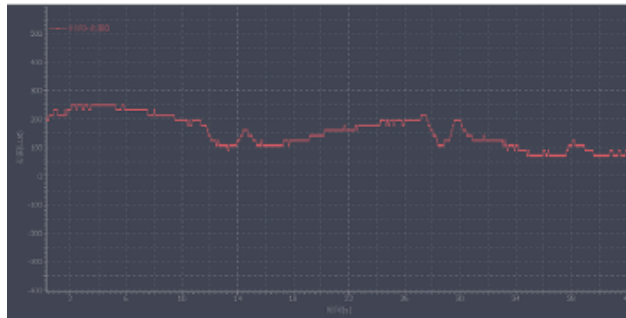

Notice:

- When use, always maintain the probe of sensor that facing light source
- Don't wear or scratch the receives of probe

Relative Humidity sensor

S1008

Range: 0~100%



Accuracy: $\pm 4\%$ (10%~90%RH)

Resolution: 0.1%



The relative humidity sensor is designed based on the sensitive humidity prototype, namely a polymer capacitance, and its capacitance will vary with the environmental humidity. The humidity sensor is designed to monitor the relative humidity of air.

Component

No.	Type	Name	Illustration
1	S1008	Relative humidity sensor	
2		Probe	

Usage

- Connect the relative humidity sensor into any port of the SensorDisc
- Insert the probe of sensor into the socket of relative humidity sensor

Typical experiment

- Measurement on the change of environmental humidity
- Design and make an ecological cylinder and observe its stability
- Transpiration of plant

Case: Measurement on environmental humidity

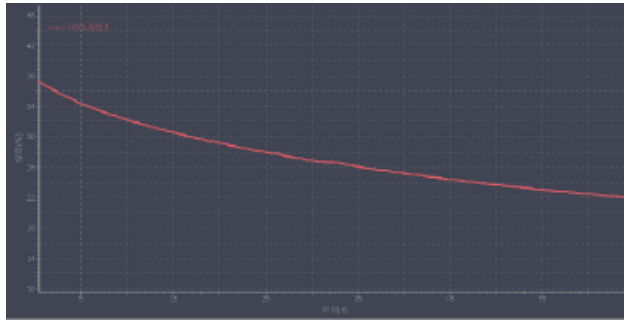

Notice:

- If the water vapor condensation in the detected environment (when is very humid), must prevent liquid invasion to the circuit part of sensor
- The response speed of humidity sensor will be faster in the flow air
- If measured environment are very dirty, you should cover sensor by nylon cloth to avoid pollution

Temperature sensor

S0009

Range: $-40\sim 135^{\circ}\text{C}$



Accuracy: $\pm 0.6^{\circ}\text{C}$

Resolution: 0.1°C



Temperature sensor adopts the NTC electronic temperature sensing element, when the ambient temperature changes, the NTC resistance changes accordingly. Normally the temperature needs no zero calibration and with relatively higher stability; therefore, the temperature sensor is rather popular in the low-middle temperature measurements.

Component

No.	Type	Name	Illustration
1	S0009	Temperature sensor	
2		Probe	

Usage

- Connect the temperature sensor into any port of the SensorDisc
- Insert the probe of sensor into the socket of temperature sensor

Typical experiment

- Water cooling
- Measure the temperature of hot and cold water
- To explore the heat transfer direction
- Compare the heat conductivity of different materials
- The convex lens convergence effect

Case: Water cooling

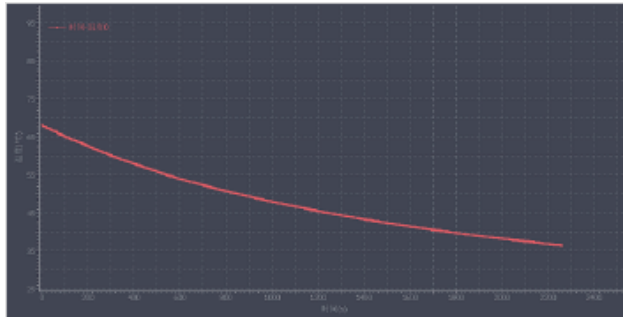

Notice:

- We can't put any part of the sensor on the open flame or heating plate directly
- When measure the temperature of liquid, should avoid the other partially of sensor immersed in liquid except stainless steel rod
- After use, cleaning sensor thoroughly
- Don't over measured range

Dissolved oxygen sensor

S1005

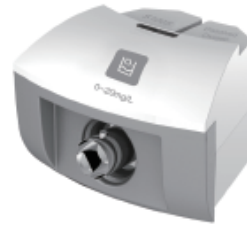

Range: 0~20mg/L

Accuracy: $\pm 0.4\text{mg/L}$ (10~35°C)



The probe of the dissolved oxygen sensor works as per the polarogram measurement principle. The probe electrode composes of the anode, cathode and membrane. When is usage, immerse the electrode into the solution and apply the electric potential between the anode and the cathode to generate the electrochemical reaction; Dissolved oxygen sensor also can be used for measuring oxygen content in gas.

Component

No.	Model	Name	Illustration
1	S1005	Dissolved oxygen sensor	
2		Probe	

Usage

- Connect the dissolved oxygen sensor into any port of the SensorDisc
- Tighten the port of electrode probe and sensor
- The probe placed in the test solution or gas environment to measure

Typical experiment

- Study the breathing way of saccharomycetes
- Study the dissolved oxygen of different water
- Factors that effect plant photosynthesis

Case: study the breathing way of saccharomycetes

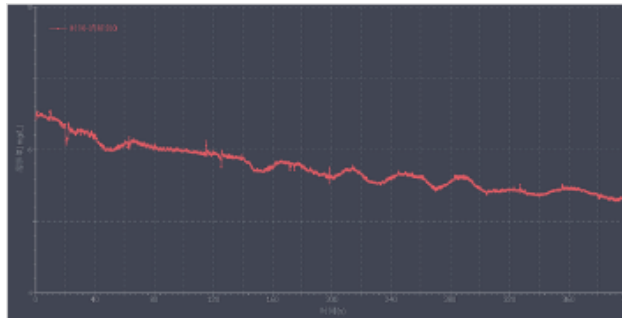

Notice:

- Avoid contact with oil or other organic matter
- If there have scale on electrode, immerse it in the 10% hydrochloric acid solution for 3 minutes, then rinse by clean water; If stained with organics, immerse it in the 8% alcohol solution for 10 minutes, then rinse by clean water;



FCC Caution.

§ 15.19 Labelling requirements.

This device complies with part 15 of the FCC Rules. Operation is subject to the following two conditions: (1) This device may not cause harmful interference, and (2) this device must accept any interference received, including interference that may cause undesired operation.

§ 15.21 Information to user.

Any Changes or modifications not expressly approved by the party responsible for compliance could void the user's authority to operate the equipment.

§ 15.105 Information to the user.

Note: This equipment has been tested and found to comply with the limits for a Class B digital device, pursuant to part 15 of the FCC Rules. These limits are designed to provide reasonable protection against harmful interference in a residential installation. This equipment generates uses and can radiate radio frequency energy and, if not installed and used in accordance with the instructions, may cause harmful interference to radio communications. However, there is no guarantee that interference will not occur in a particular installation. If this equipment does cause harmful interference to radio or television reception, which can be determined by turning the equipment off and on, the user is encouraged to try to correct the interference by one or more of the following measures:

- Reorient or relocate the receiving antenna.
- Increase the separation between the equipment and receiver.
- Connect the equipment into an outlet on a circuit different from that to which the receiver is connected.
- Consult the dealer or an experienced radio/TV technician for help.

* RF warning for Portable device:

The device has been evaluated to meet general RF exposure requirement. The device can be used in portable exposure condition without restriction.

JIANGSU SWR SCIENCE & TECHNOLOGY CO., LTD.

Address: No.14 Junnong Road, Qinhuai District, Nanjing, Jiangsu Province, China
P.C.: 210007

Tel: +86-25-51885166

Fax: +86-25-83202846-828

Web: www.sensedisc.com

Email: wzf@sinoswr.com