



TRAVEL COT

So Gifted!



MANUAL INSTRUCTION

fig.1 PARTS

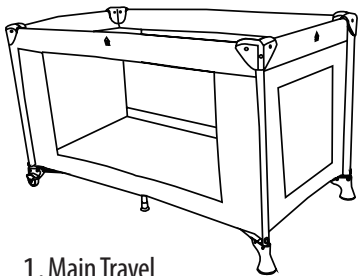

1. Main Travel Cot Body.

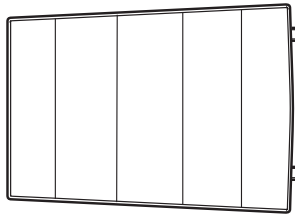

2. Travel cot mattress.



3. Travel bag.

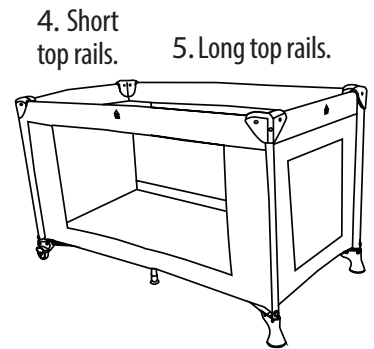

4. Short top rails.

5. Long top rails.

fig.2 OPENING TRAVEL COT



1. Remove travel cot from carry bag.

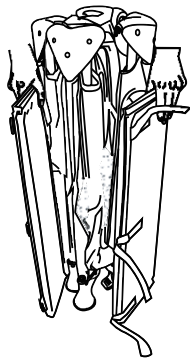

2. Remove mattress from around the travel cot.



3A

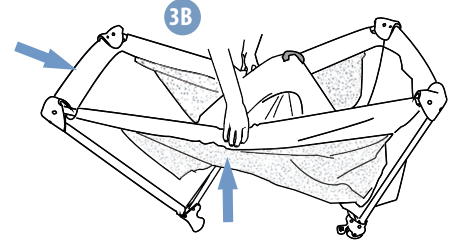

3B

3-4. While holding the strap to keeping the centre of travel cot floor upright (3A), use your other hand to lift the short top rails (3B) until locked into position. Repeat step 3 for both long top rails. The centre of travel cot floor must remain upright until all rails are locked.



**IMPORTANT!!!** DO NOT push centre of travel cot floor down until all top rails are locked.

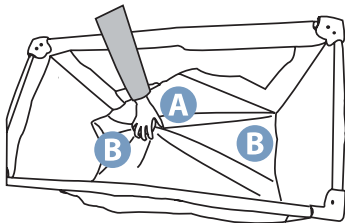

5. Once all sides are locked into position, extend all corners and press centre of floor down (A) followed by outside edges (B), until travel cot floor is in the locked position.

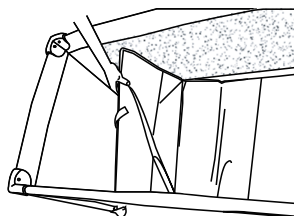

6. Add mattress to travel cot with soft side up.

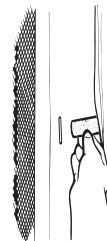

7. Put the straps under mattress through button holes and fasten securely on button of unit. Do not use travel cot without mattress.

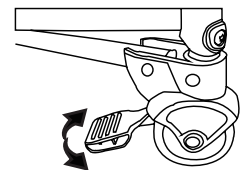

8. Push down the pedal to activate the brakes.

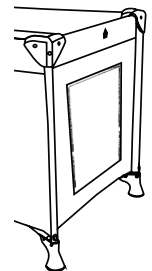

9. Side window with zip fastener

fig3

### CLOSING THE TRAVEL COT

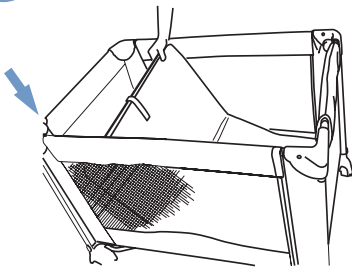

1. Remove mattress from travel cot.

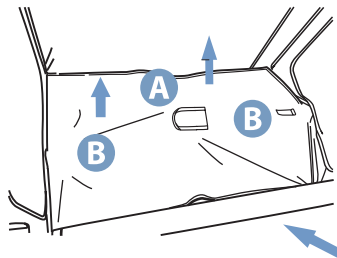

2. Hold the strap, pull centre of floor upwards(a).

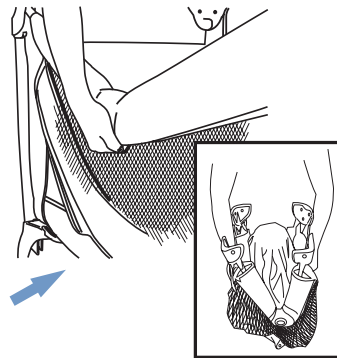

3. Slightly lift top rail while pressing the centre button to release. Once rails released, push down. The centre of the cot floor must be pulled up for top rails to release, if you can't release the centre button freely, lift centre plastic handle bar higher. Do not

force. If unit will not fold, look for a partially latched top rail. Squeeze the latch button to release the rail. It is possible for only one side of the rail to release, ensure the rail is released on both sides of the latch button.



4. Once all top rails are released, fold travel cot to standing position.

fig4

### STORING

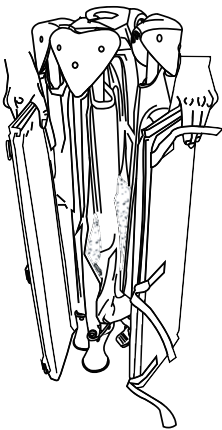

1. With travel cot in upright position, route top hook and loop strap through plastic loops on opposite side of mattress.

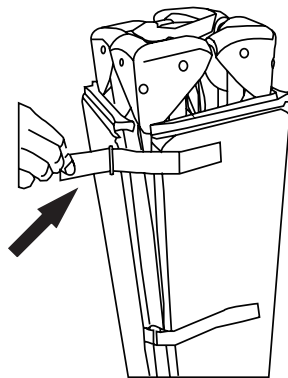

2-3. With soft side of mattress facing the travel cot route the two lower hook and loop straps through remaining plastic loops on mattress.

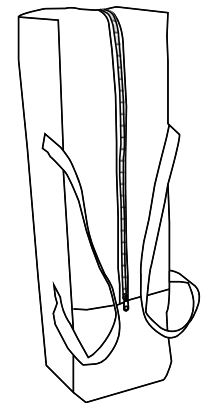
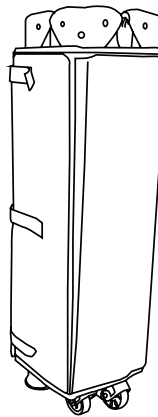

4. Insert travel cot into carry bag and handle exposed for easy transportation.

\* Store in a cool and dry area, especially in the summer. Do not store the travel cot in the boot of a vehicle.

\* Carefully wipe off any mud and dirt. To clean the body, wipe with a damp cloth. The main body might become moldy and musty if not wiped dry.

\* Excessive exposure to the sun could cause premature colour fade.

\* Mattress and bag are NOT machine washable. Clean with mild soap and a damp cloth.

## USER'S INFORMATION

### **IMPORTANT! Read carefully. Retain for future reference.**

- Discontinue using your travel cot when the child's weight is more than 14kg or is able to climb out to prevent risk of injury from falls.
  - Your travel cot, including side rails and bottom pad, must be fully assembled prior to use
  - Top and side rails must be completely latched.
  - The folding mechanism on the centre of the bottom of the cot must be locked.
  - Mattress must be flat and secured by hook and loop straps.
  - Always use the mattress provided with the cot.
  - The cot is ready for use, only when the locking mechanisms are all engaged. Please check carefully that they are fully engaged before using the folding cot.
  - Use **ONLY** the base mattress supplied as it has been designed to fit with this travel cot in order to meet safety standards. Using a thicker or a different sized mattress may allow a child's head to get between mattress and the side of the travel cot causing suffocation.
  - **WARNING!** Never add a mattress to the one supplied with the cot, **TO AVOID SUFFOCATION, DO NOT** use extra padding such as a water mattress, mattress or pillows inside the travel cot.
  - To protect your child from falls and other injuries.
  - **WARNING!** Do not place the bed in a position where child could reach any objects. Always keep objects out of child's reach.
  - **WARNING!** Be aware of the risk of open fire and other sources of strong heat such as electric bar fires, gas fires etc. in the vicinity of the travel cot.
  - Always use on a flat, level floor.
  - Keep away from trailing cords, flexes and lamps.
  - Should the padded rim be damaged enough to expose the padding, do not use the travel cot.
  - Regularly check the locks and fittings for a secure fit.
  - All assembly fittings should be checked and tightened properly as parts of the body or clothing can get caught with a danger of strangulation.
  - When folding the travel cot, do not force on the side rails. Repeat the folding operations.
  - When folded, store away from children.
  - Do not allow other children to play unsupervised in the vicinity of the travel cot.
  - Maximum thickness of 19mm.
  - **WARNING!** Be aware of the risk of open fire and other sources of strong heat, such as electric bar fires, gas fires, etc. In the near vicinity of the cot.
- The minimum size of the mattress to be used with the cot:  
120cm(L) x 60cm(W). The length and width shall be such that the gap between the mattress and the sides and ends does not exceed 30mm.
- **WARNING!** Do not use the cot if any part is broken, torn or missing and use only spare parts approved by the manufacturer.
  - **WARNING!** Ensure that the cot is fully erected and all the locking mechanisms engaged before placing your child in the cots.
  - EN716-1/2:2008+A1:2013