

InFocus



Quantum
LASER

Quantum Laser Superior Series

INL2156, INL2166, INL2158, INL2159, INL2168, INL2169

INSTALLATION AND USERS GUIDE

TABLE OF CONTENTS

INFOCUS_COVER PAGE_V02

1. ABOUT THIS GUIDE

1.1 Description of the User	7
1.2 Conventions Used in this Guide	7
1.3 Explanation of Safety Warnings	7
1.4 Retaining Instructions	7
1.5 Obtaining Documentation and Information	8
1.6 Documentation Feedback	8
1.7 Support and Service	8

2. PRODUCT DESCRIPTION

2.1 Features	9
2.2 Intended Use and Reasonably Foreseeable Misuse	10
2.3 Product Elements	11

3. SAFETY

3.1 How to Use the Product Safely	14
3.2 Safe Disposal	15
3.3 Graphical Symbols	16

4. UNPACKING AND INSTALLING

4.1 Package Contents	17
4.2 Installation Options	17
4.3 Placement Distance from Screen	18
4.4 Clearance	22
4.5 Ceiling Mount	23
4.6 Mounting Hole Diagram	24

5. ADJUSTING

5.1 Adjusting the Image Height and Tilt	25
5.2 Adjusting the Zoom, Lens Shift, and Focus	25
5.3 Adjusting the Vertical or Horizontal Keystone	26

6. CONNECTING

6.1 Connection Diagram	28
------------------------	----

7. USING

7.1 LEDs	29
7.2 Keypad	29
7.3 Remote Control	30
7.4 Remote Effective Range	32

7.5 Turning the Projector On	32
7.6 Selecting an Input Source	32
7.7 Turning the Projector to Standby Mode	33
7.8 Viewing 3D Content	33

8. USING THE ON SCREEN DISPLAY (OSD) MENU

8.1 Selecting the Language for the On Screen menu	37
8.2 Selecting a Display Mode	37
8.3 Adjusting the Image Colour Temperature	38
8.4 Adjusting the Sharpness	38
8.5 Magnifying the Image	38
8.6 Selecting an Aspect Ratio	38
8.7 Adjusting the Brightness	38
8.8 Enabling ECO Mode	39
8.9 Enabling Closed Captions	39
8.10 Displaying a Test Pattern	39
8.11 Preventing Unauthorized Use	39
8.12 Changing the Password	40
8.13 Controlling the Projector from a Web Browser	40
8.14 Directly Connecting a Computer to the Projector	41

9. CLEANING

- 9.1 Cleaning the Lens 42
- 9.2 Cleaning the Case 42
- 9.3 Cleaning the Air Intake Vents 42

10. SANITATION 43

11. DISPOSAL

- 11.1 Disposal of Electronic Components 44
- 11.2 Disposal of Packaging Waste 44

12. TROUBLESHOOTING

- 12.1 LED Indicator Lights 45
- 12.2 Solving On/Off Issues 45
- 12.3 Solving Image Issues 46
- 12.4 Solving Video, Audio, and Remote Control Issues 47
- 12.5 Repair by Skilled Persons 47

13. ADDITIONAL INFORMATION

- 13.1 RS232 Pin Assignments 48
- 13.2 RS232 Protocol Function List 49

13.3 Supported Resolutions and Refresh Rates	50
13.4 On screen Display (OSD) Menu Tree	53
SPECIFICATIONS	60
PRODUCT COMPLIANCE	63
WARRANTY	65

1. ABOUT THIS GUIDE

1.1 DESCRIPTION OF THE USER

This document is intended for anyone who will install, setup, or use the projector.

1.2 CONVENTIONS USED IN THIS GUIDE

The following style conventions are used in this document:

Bold

- Names of product elements, commands, options, and programs
- Names of interface elements (such windows, dialog boxes, buttons, fields, and menus)
- Interface elements the user selects, clicks, taps, or types

Italic

- Publication titles
- Emphasis (for example, a new term)

1.3 EXPLANATION OF SAFETY WARNINGS

⚠ DANGER

"DANGER" indicates a hazard with a high level of risk which, if not avoided, will result in death or serious injury.

⚠ WARNING

"WARNING" indicates a hazard with a medium level of risk which, if not avoided, could result in death or serious injury.

⚠ CAUTION

"CAUTION" indicates a hazard with a low level of risk which, if not avoided, could result in minor or moderate injury.

NOTICE

"NOTICE" Indicates information considered important, but not hazard-related.

1.4 RETAINING INSTRUCTIONS

Ensure that each person who uses the product has read and understood this guide and its safety instructions before using this product. Failure to do so can result in serious injury or death.

Follow all the instructions. This will avoid fire, explosions, electric shocks or other hazards that may result in damage to property and/or severe or fatal injuries.

Keep all safety information and instructions for future reference and pass them on to subsequent users of the product.

The manufacturer is not liable for cases of material damage or personal injury caused by incorrect handling or non-compliance with the safety instructions. In such cases, the warranty will be voided.

1.5 OBTAINING DOCUMENTATION AND INFORMATION

The latest version of the documentation is available at the following address: infocus.com/support-category/projector.

1.6 DOCUMENTATION FEEDBACK

If you are reading InFocus product documentation on the internet, any comments can be submitted on the InFocus website at the following address: infocus.com/support. We appreciate your comments.

1.7 SUPPORT AND SERVICE

Please contact the InFocus support team in your region for technical and product support. Alternatively, you may contact your local distributor if you are in Asia or Australia.

<p style="text-align: center;">Americas Monday – Friday 6am – 5pm PST</p> <p style="text-align: center;"> +1 877-388-8360  support@infocus.com  infocus.com/support/contact</p>	<p style="text-align: center;">Europe, Middle East & Africa Monday – Friday 8am – 5pm CET</p> <p style="text-align: center;"> eusupport@infocus.com  infocus.com/support/contact</p>
<p style="text-align: center;">Asia Pacific Monday – Friday 8am – 5pm ICT</p> <p style="text-align: center;"> support@infocus.com  infocus.com/support/contact</p>	<p style="text-align: center;">Australia Monday – Friday 8am – 5pm AEST</p> <p style="text-align: center;"> support@infocus.com  infocus.com/support/contact</p>

2. PRODUCT DESCRIPTION

The next generation of laser projection is here!

With this multi-purpose, multi-use range of laser projectors, you get far more than an image on the wall. Content bursts to life, and viewing becomes an absolute pleasure and a next-level experience in any environment. Viewing presentations in the workplace offers much more crisp detail and readability. Engage more in the classroom and have peace of mind that you and your students or classmates are using the latest cutting-edge, environmentally friendly, energy-efficient display technology on the market.

2.1 FEATURES

The following table lists the features of the projector.

Environmentally-friendly laser technology

The lamp-free Quantum Laser DLP series with solid-state laser light source technology eliminates the heavy metals mercury and lead. The ultra-low energy usage and long-standing durability and performance offer outstanding value and a low cost of ownership.

4K support

Simply stunning image quality with up to WUXGA (1920 x 1200) native resolution and HDMI 2.0 (HDCP 2.2) 4K support. HDR compatible for life-like texture details and improved image depth perception.

SuperSmartProject

Our SuperSmartProject suite of power-saving, power optimisation, and utilisation features and functions combine ease of use and energy saving for your everyday use. Instant power on, signal power on, instant power-off, auto power-off, 10 step illumination reduction, and Dynamic Black optimisation all enhance your viewing experience while optimising energy usage.

Flexible installation

Flexibility for almost every surface with a 1.3x optical zoom lens, front, rear, and ceiling placement, floor-to-ceiling and ceiling-to-floor projection, complete 360-degree flexibility across the horizontal axis, and landscape and portrait modes make Quantum Laser projectors ideal for homes, classrooms, retail displays, fixed installations, bars, clubs, and restaurants.

Vertical lens shift

Simplify installation with vertical lens shift, providing a broader range of projector placement options and screen size options. It makes it easier to position the projector in your room, aids in alignment of the projector to screen and eliminates the need for keystone correction.

Four corner correction

You can individually warp each corner of the image to create a perfectly square image. Ideal for image stacking, uneven walls, or locations where the projector needs installing at an angle.

Auto keystone

Auto keystone automatically adjusts the trapezoid effect when the projector is off-axis to create a vertically-aligned image.

24/7 operation

The design of the projector allows it to operate 24 hours a day in standard orientation.

For optimum performance, InFocus recommends that your projector is turned off or placed in standby mode for 30 minutes every 24 hours to prolonging the life of the projector light source. The projector has warranty coverage based on standard business usage hours.

Advanced security features

A Kensington Lock Port™ keypad PIN protection with Timer Functions.

Networked

With all models featuring a RJ45 connection allowing you to monitor and control your network of projectors across multiple rooms with support for Crestron, Extron, AMX, PJ-Link and Telnet LAN commands.

IP6X airtight optics

Featuring IP6X dust resistance rating. Outstanding dust resistance ensures industry leading durability; paramount for 24/7 maintenance free operation in demanding environments.

1080p & WUXGA native resolutions

1080p resolution gives you sharp and detailed images from HD content without downscaling or compression; perfect for watching Blu-ray movies, HD broadcasting and playing video games. WUXGA resolution provides native 16:10 HD support for the business and commercial environment.

High-dynamic-range (HDR) Compatible

Capable of receiving and displaying HDR meta data for support of HDR10 & Dolby Vision, HDR formats. To represent substantially brighter highlights, darker shadows, more details in both sides, and more colourful colours than what was previously possible.

2.2 INTENDED USE AND REASONABLY FORESEEABLE MISUSE

The projector may only be used in accordance with the instructions described in this guide. Any use other than those described in this guide is considered non-intended use and will void the warranty.

Do not use the projector near water or moisture. Do not expose the projector to rain, steam or condensation to reduce the risk of fire or electric shock.

The ambient operating environment should be free of airborne smoke, grease, oil and other contaminants that can affect the operation or performance of the projector.

2.3 PRODUCT ELEMENTS

2.3.1 FRONT AND TOP

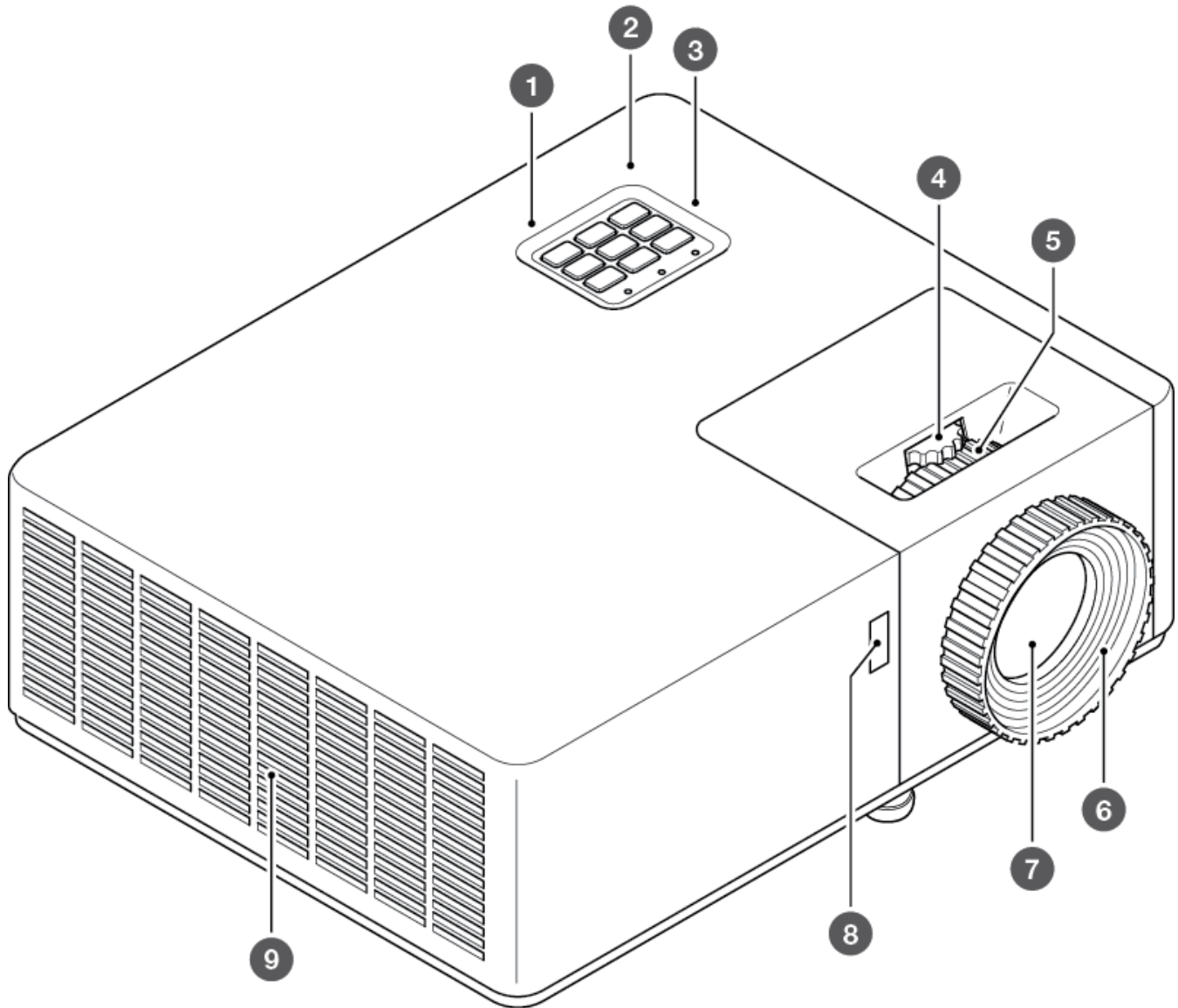

- Top IR sensor
- Keypad
- LED function lights
- Vertical lens shift (INL2166, INL2168, INL2169)
- Optical zoom ring
- Focus ring
- Projector lens
- Front IR sensor
- Air outtake vent

2.3.2 BASE

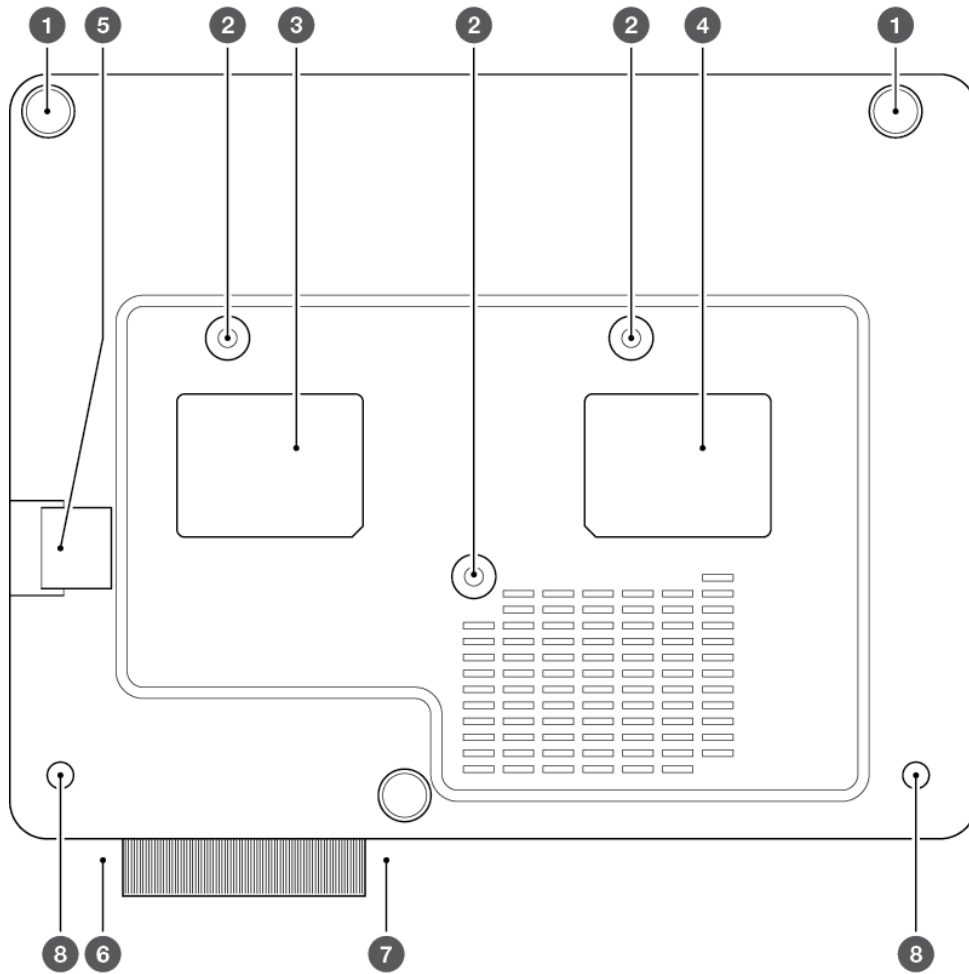

- ① Rear feet (2)
- ② Ceiling mount points (3)
- ③ Laser risk label (do not remove)
- ④ Regulatory label (do not remove)
- ⑤ Security cable attachment point
- ⑥ Lens cap attachment point
- ⑦ Front foot
- ⑧ Front fixed stabiliser feet (2)

2.3.3 REAR & I/O CONNECTION PANEL

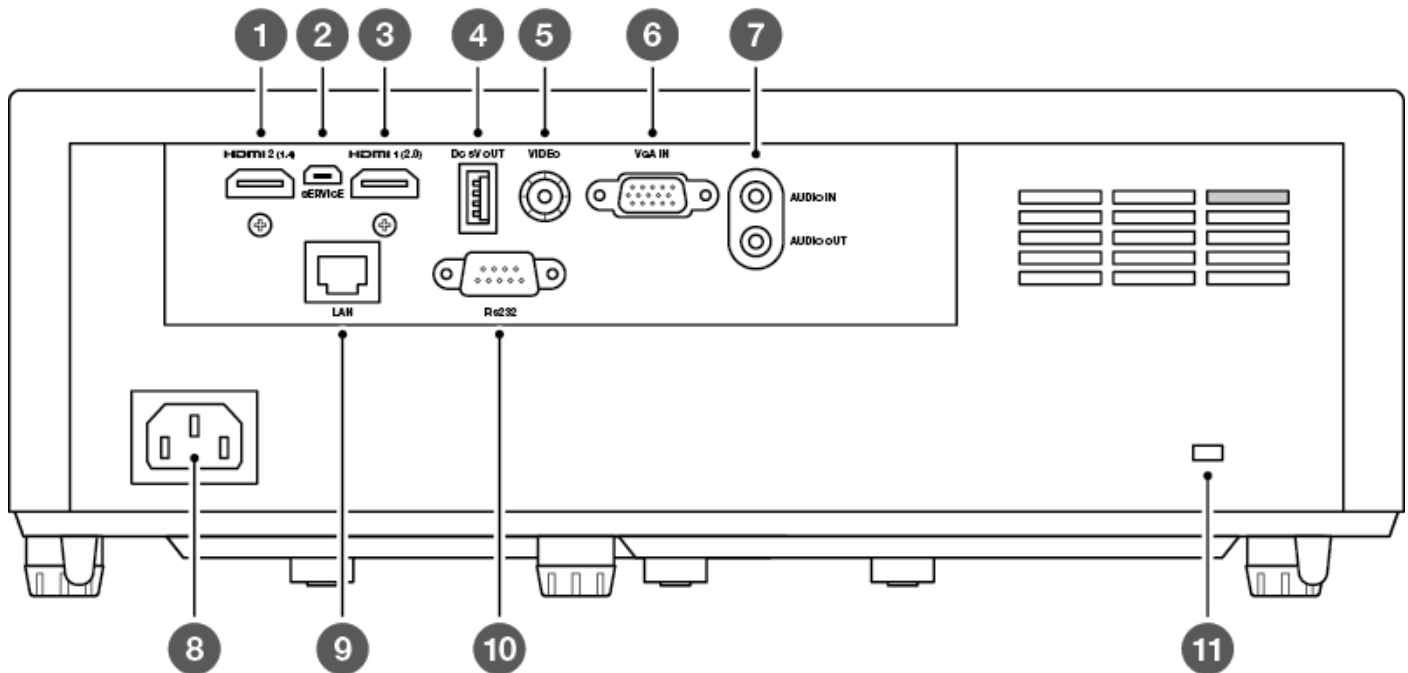

- ① HDMI 2 (1.4) - HDMI 1.4 for 3D support and input signals up to 4K at 30 frames per second
- ② SERVICE - connect a USB cable to update the projector's firmware
- ③ HDMI 1 (2.0) - HDMI 2.0 with HDCP 2.2 for up to 4K input signals at 60 frames per second
- ④ DC 5V OUT - connect a USB cable for power out
- ⑤ VIDEO - connect a composite video cable for video output
- ⑥ VGA IN - connect a VGA video cable for video input
- ⑦ AUDIO IN & OUT - connect an AUX cable for audio input or output
- ⑧ POWER - connect the power cable to a mains wall outlet
- ⑨ LAN - connect to a network using an RJ45 cable
- ⑩ RS232 - connect an RS232 cable to control the projector from a PC
- ⑪ Kensington Security Slot

3. SAFETY

⚠ WARNING

Read and understand this guide and its safety instructions before using this product. Failure to do so can result in serious injury or death.

3.1 HOW TO USE THE PRODUCT SAFELY

3.1.1 VULNERABLE PEOPLE SAFETY INFORMATION

- This device is not intended for use by persons (including children) with restricted physical, sensory or intellectual capability or lack of experience and/or knowledge.
- The projector complies with the safety standards for electromagnetic devices. Contact your physician prior to use if you have a pacemaker or other implanted device.

3.1.2 TECHNICAL LIFE SPAN

The technical lifespan of the projector is five years or 20,000 hours of use in normal mode and 30,000 hours of use in ECO mode under normal operating conditions (whichever comes first).

3.1.3 INTENDED USE SAFETY INFORMATION

Use the projector only for its intended use as described in this user guide.

Do not expose the projector to temperatures above 104°F / 40°C or below 32°F / 0°C.

3.1.4 INSTALLATION SAFETY INFORMATION

- Check the projector for damage before installation. If there is any visible damage, do not connect the projector and contact InFocus.
- Do not install the projector:
 - near heat sources such as radiators, heat registers, stoves, or other devices that produce heat
 - near water or in direct sunlight
 - in an enclosure such as a book case or a cabinet that restricts air flow

3.1.5 ELECTRICAL SAFETY INFORMATION

- Check for damage before connecting the power cable.
- Only connect the projector to a grounded socket with earth leakage protection using the provided power cable.

- Immediately unplug the projector from the wall outlet:
 - if it has been damaged
 - if water or another substance enters the projector
 - if you smell smoke or other odors coming from the projector
 - during lightning storms
 - when unused for long periods of time

3.1.6 LASER SAFETY INFORMATION

Do not stare into the direct beam.



	<p>IEC/EN 60825-1:2014 CLASS 1 LASER PRODUCT RISK GROUP 2 Complies with 21 CFR 1040.10 and 1040.11 except for conformance as a Risk Group 2 LIP as defined in IEC 62471-5:Ed. 1.0. For more information see Laser Notice No. 57, dated May 8, 2019.</p> <p>IEC/EN 60825-1:2014 PRODUIT LASER DE CLASSE 1 GROUPE DE RISQUE 2 Conforme aux normes 21 CFR 1040.10 et 1040.11, à l'exception de la conformité en tant que LIP du groupe de risque 2 définie dans la CEI 62471-5: Ed. 1,0. Pour plus d'informations, voir l'avis au laser n° 57 du 8 mai 2019.</p> <p>IEC/EN 60825-1:2014 1類雷射產品RG2危險等級 除了IEC 62471-5:Ed.1.0中定義的RG2 LIP 危險等級以外，要符合21 CFR 1040.10和1040.11，更多相關資訊，請參閱2019年5月8日的第57號雷射公告。</p> <p>IEC/EN 60825-1:2014 1类激光产品RG2危險等級 除了IEC 62471-5:Ed.1.0中定义的RG2 LIP 危險等級以外，要符合21 CFR 1040.10和1040.11，更多相關信息，請參閱2019年5月8日的第57號激光公告。</p>
--	---

3.1.7 MAINTENANCE SAFETY INFORMATION

- Review the instructions in the CLEANING section before cleaning the projector.
- Disconnect the power supply before cleaning the projector. Do not use abrasive cleaning cloths or chemicals.

3.1.8 SERVICE AND REPAIR SAFETY INFORMATION







The projector contains no user serviceable parts. Contact InFocus for service or repair.

3.2 SAFE DISPOSAL

Follow the instructions in the DISPOSAL section in this user guide for safe disposal of the projector.

3.3 GRAPHICAL SYMBOLS

The following table describes the safety and regulatory symbols and marks on the packaging and product.

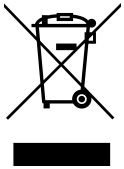
Symbol	Meaning
	The CCC mark on the product is the manufacturer's declaration that the product complies with the essential requirements for the relevant safety legislation of China.
	The CE mark on the product is the manufacturer's declaration that the product complies with the essential requirements of the relevant European health, safety and environmental protection legislation.
	The TÜV seal on a product is a seal of quality that confirms that the product has been tested by the German TÜV testing organization.
	The EAC mark on the product is the manufacturer's declaration that the product complies with the essential requirements of the relevant safety legislation of the Eurasian Economic Union (EAEU).
	The FCC mark on the product is the manufacturer's declaration that the product's electromagnetic radiation is below the limits specified by the Federal Communication Commission (FCC).
	The NOM mark on the product is the manufacturer's declaration that the product complies with the essential requirements of the relevant Mexican safety legislation.
	The RoHS mark on the product is the manufacturer's declaration that the product complies with the essential requirements of the relevant European Union safety legislation.
	The Waste Electrical and Electronic Equipment (WEEE) symbol on the product, the accessories, or packaging indicates that this device shall not be treated as unsorted municipal waste, but shall be collected separately.

4. UNPACKING AND INSTALLING

4.1 PACKAGE CONTENTS

The projector packaging will contain:

- Projector
- Power cable
- HDMI cable
- Remote control (batteries not included)
- Lens cap
- Quick Start guide

4.2 INSTALLATION OPTIONS

Your projector can be installed at any angle or orientation. Select an installation position based on:

- Your room layout or orientation
- The size and position of your screen or projection surface
- The location of a suitable power outlet
- The location of the source devices you plan to use

"WARNING: MOUNT ABOVE THE HEADS OF CHILDREN."

Additional warning against eye exposure for close exposures less than 1 m.

"AVERTISSEMENT : INSTALLER AU-DESSUS DE LA TÊTE DES ENFANTS."

Avertissement supplémentaire contre l'exposition oculaire pour des expositions à une distance de moins de 1 m.

“警告：安裝在高於孩童頭頂處”

關於小於1 m 近距離眼睛暴露的附加警告

「警告：安裝在高於兒童頭部處」

針對 1 m 以下近距離眼睛接觸的額外警告

4.3 PLACEMENT DISTANCE FROM SCREEN

The projected image size will increase based on the projector's distance from the screen or projection surface. You can use the following tables to determine the best location for the projector and screen.

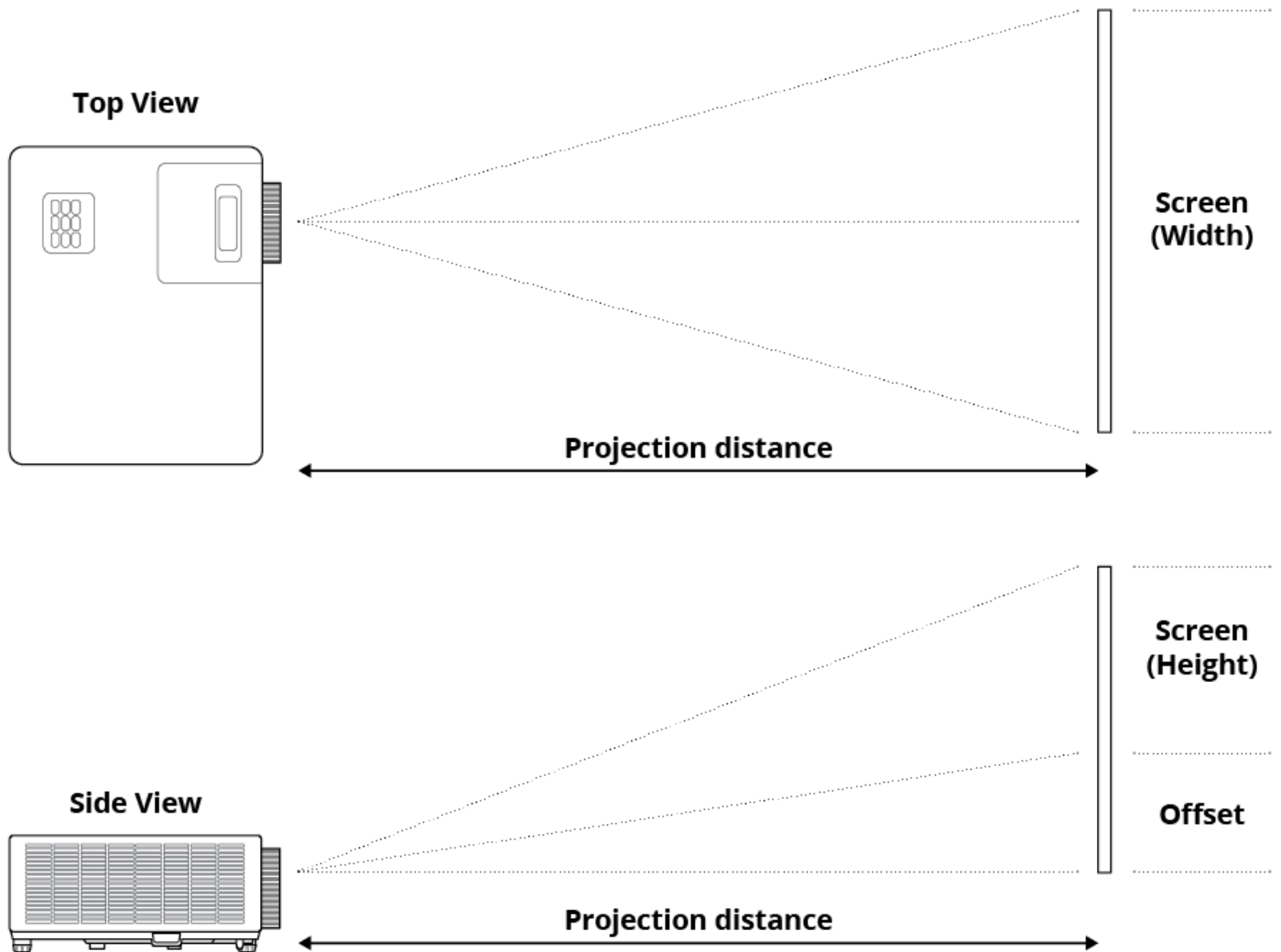

4.3.1 1080P MODELS - 1.3X ZOOM LENS

Screen Size					Projection Distance (PD)					
Inches	Meters		Inches		Meters		Feet		Offset (OFS)	
Diagonal (D)	Width (W)	Height (H)	Width (W)	Height (H)	Wide	Tele	Wide	Tele	Meters	Inches
28.3	0.63	0.35	24.67	13.87	-	1	-	3.28	0.04	1.57
40	0.89	0.5	34.86	19.6	1.1	1.4	3.61	4.59	0.05	1.97
50	1.11	0.62	43.58	24.5	1.3	1.8	4.27	5.91	0.06	2.36
60	1.33	0.75	52.29	29.4	1.6	2.1	5.25	6.89	0.07	2.76
70	1.55	0.87	61.01	34.3	1.9	2.5	6.23	8.2	0.09	3.54
80	1.77	1	69.73	39.2	2.1	2.8	6.89	9.19	0.1	3.94
90	1.99	1.12	78.44	44.1	2.4	3.2	7.87	10.5	0.11	4.33
100	2.21	1.25	87.16	49	2.7	3.5	8.86	11.48	0.12	4.72
120	2.66	1.49	104.59	58.8	3.2	4.2	10.5	13.78	0.15	5.91
150	3.32	1.87	130.74	73.5	4	5.3	13.12	17.39	0.18	7.09
180	3.98	2.24	156.88	88.2	4.8	6.3	15.75	20.67	0.23	9.06
200	4.43	2.49	174.32	98.1	5.4	7	17.72	22.97	0.25	9.84
250	5.53	3.11	217.89	122.6	6.7	8.8	21.98	28.87	0.31	12.2
300	6.64	3.74	261.47	147.1	8	-	26.25	-	0.37	14.57
374	8.28	4.66	325.97	183.4	10	-	32.81	-	0.46	18.11

4.3.2 WUXGA SERIES - 1.3X ZOOM LENS

Screen Size					Projection Distance (PD)					
Inches	Meters		Inches		Meters		Feet		Offset (OFS)	
Diagonal (D)	Width (W)	Height (H)	Width (W)	Height (H)	Wide	Tele	Wide	Tele	Meters	Inches
29.2	0.63	0.39	24.76	15.48	-	1.0	-	3.28	0.04	1.57
40	0.86	0.54	33.92	21.2	1.0	1.4	3.28	4.59	0.05	1.97
50	1.08	0.67	42.40	26.5	1.3	1.7	4.27	5.58	0.07	2.76
60	1.29	0.81	50.88	31.8	1.6	2.1	5.25	6.89	0.08	3.15
70	1.51	0.94	59.36	37.1	1.8	2.4	5.91	7.87	0.10	3.94
80	1.72	1.08	67.84	42.4	2.1	2.7	6.89	8.86	0.10	3.94
90	1.94	1.21	76.32	47.7	2.3	3.1	7.55	10.17	0.12	4.72
100	2.15	1.35	84.80	53	2.6	3.4	8.53	11.15	0.13	5.12
120	2.58	1.62	101.76	63.6	3.1	4.1	10.17	13.45	0.16	6.30
150	3.23	2.02	127.20	79.5	3.9	5.1	12.80	16.73	0.20	7.87
180	3.88	2.42	152.64	95.4	4.7	6.2	15.42	20.34	0.25	9.84
200	4.31	2.69	169.60	106	5.2	6.8	17.06	22.31	0.27	10.63
250	5.38	3.37	212.00	132.5	6.5	8.6	21.33	28.22	0.33	12.99
300	6.46	4.04	254.40	159	7.8	-	25.59	-	0.40	15.75
383.7	8.26	5.17	325.38	203.4	10.0	-	32.81	-	0.51	20.08

4.3.3 WXGA MODELS - 1.3X ZOOM LENS

Screen Size					Projection Distance (PD)					
Inches	Meters		Inches		Meters		Feet		Offset (OFS)	
Diagonal (D)	Width (W)	Height (H)	Width (W)	Height (H)	Wide	Tele	Wide	Tele	Meters	Inches
30.1	0.65	0.41	25.52	15.95	-	1.0	-	3.28	0.05	1.97
40	0.86	0.54	33.92	21.2	1.0	1.3	3.28	4.27	0.07	2.76
50	1.08	0.67	42.40	26.5	1.3	1.7	4.27	5.58	0.09	3.54
60	1.29	0.81	50.88	31.8	1.5	2.0	4.92	6.56	0.10	3.94
70	1.51	0.94	59.36	37.1	1.8	2.3	5.91	7.55	0.12	4.72
80	1.72	1.08	67.84	42.4	2.0	2.7	6.56	8.86	0.13	5.12
90	1.94	1.21	76.32	47.7	2.3	3.0	7.55	9.84	0.15	5.91
100	2.15	1.35	84.80	53	2.5	3.3	8.20	10.83	0.16	6.30
120	2.58	1.62	101.76	63.6	3.0	4.0	9.84	13.12	0.20	7.87
150	3.23	2.02	127.20	79.5	3.8	5.0	12.47	16.40	0.25	9.84
180	3.88	2.42	152.64	95.4	4.6	6.0	15.09	19.69	0.30	11.81
200	4.31	2.69	169.60	106	5.1	6.6	16.73	21.65	0.34	13.39
250	5.38	3.37	212.00	132.5	6.4	-	21.00	-	0.41	16.14
300	6.46	4.04	254.40	159	7.6	-	24.93	-	.50	19.69

4.4 CLEARANCE

Allow at least 30cm clearance around the intake and exhaust vent and ensure that the intake vents do not recycle hot air from the exhaust vent.

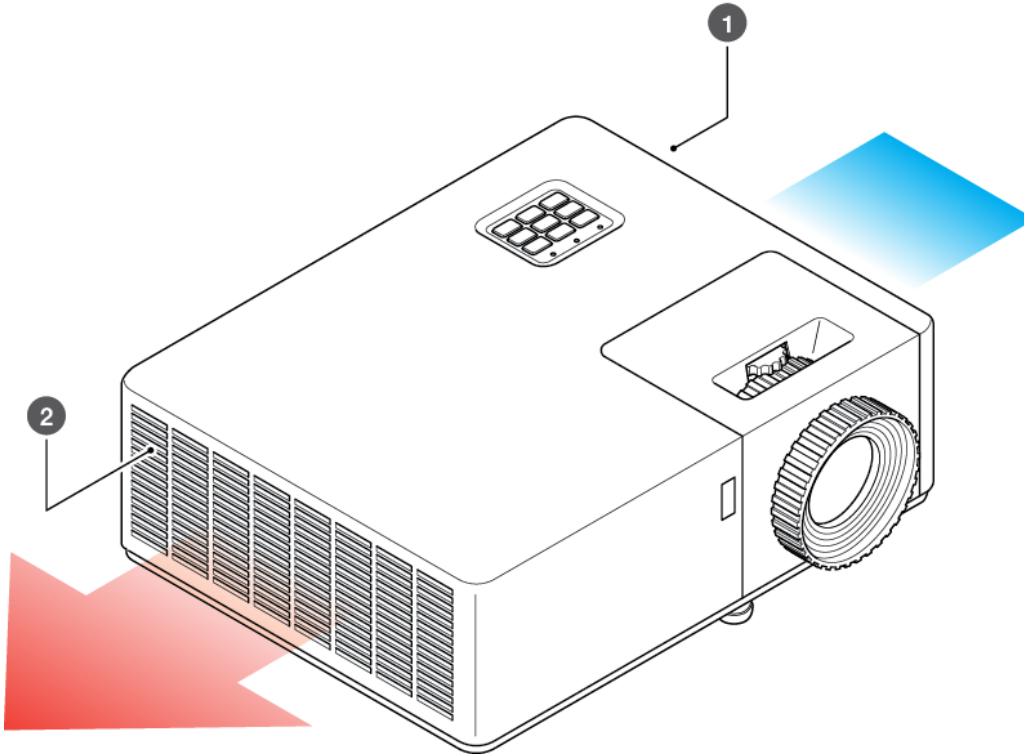

① Air intake vent

② Air outtake vent

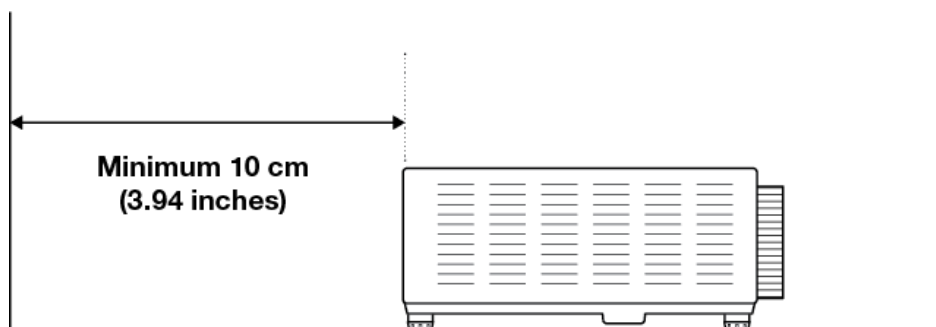
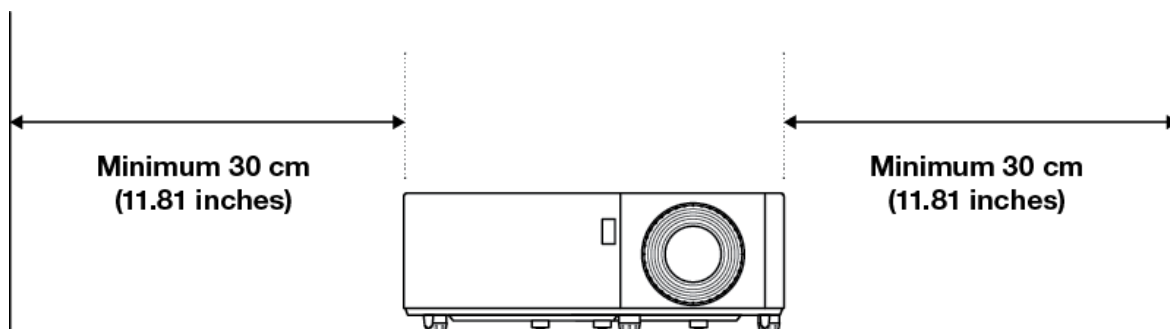

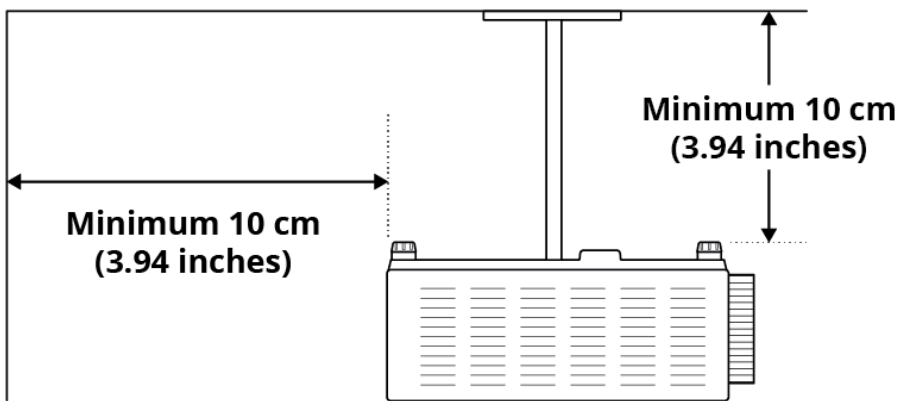

When operating the projector in an enclosed space:

- The surrounding air temperature within the enclosure should not exceed operation temperature while the projector is running
- The air intake and exhaust vents should be unobstructed
- The enclosure should pass a certified thermal evaluation to ensure that the projector does not recycle exhaust air

4.5 CEILING MOUNT

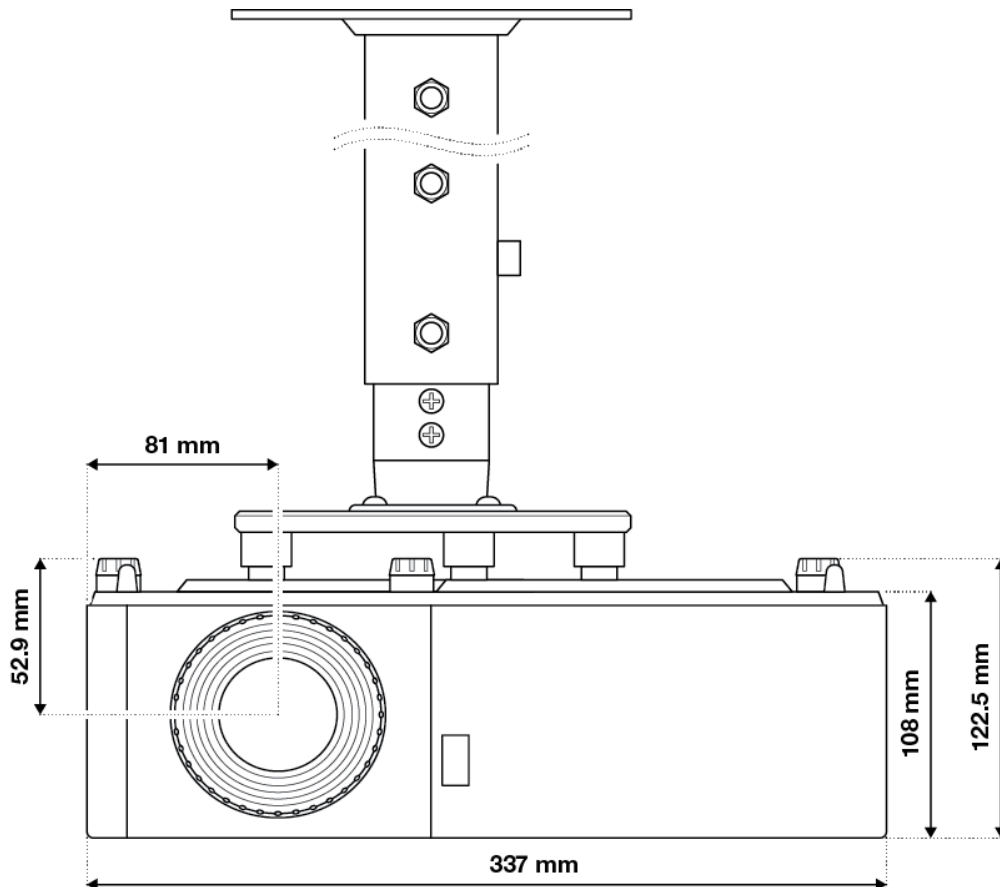

To prevent damage to your projector, please use only approved InFocus ceiling mounts: www.infocus.com/accessories/mounts

If you wish to use a third party ceiling mount kit, please ensure the screws used to attach a mount to the projector meet the following specifications:

- Screw type: M4 XL
- Minimum screw length: 9mm

4.6 MOUNTING HOLE DIAGRAM

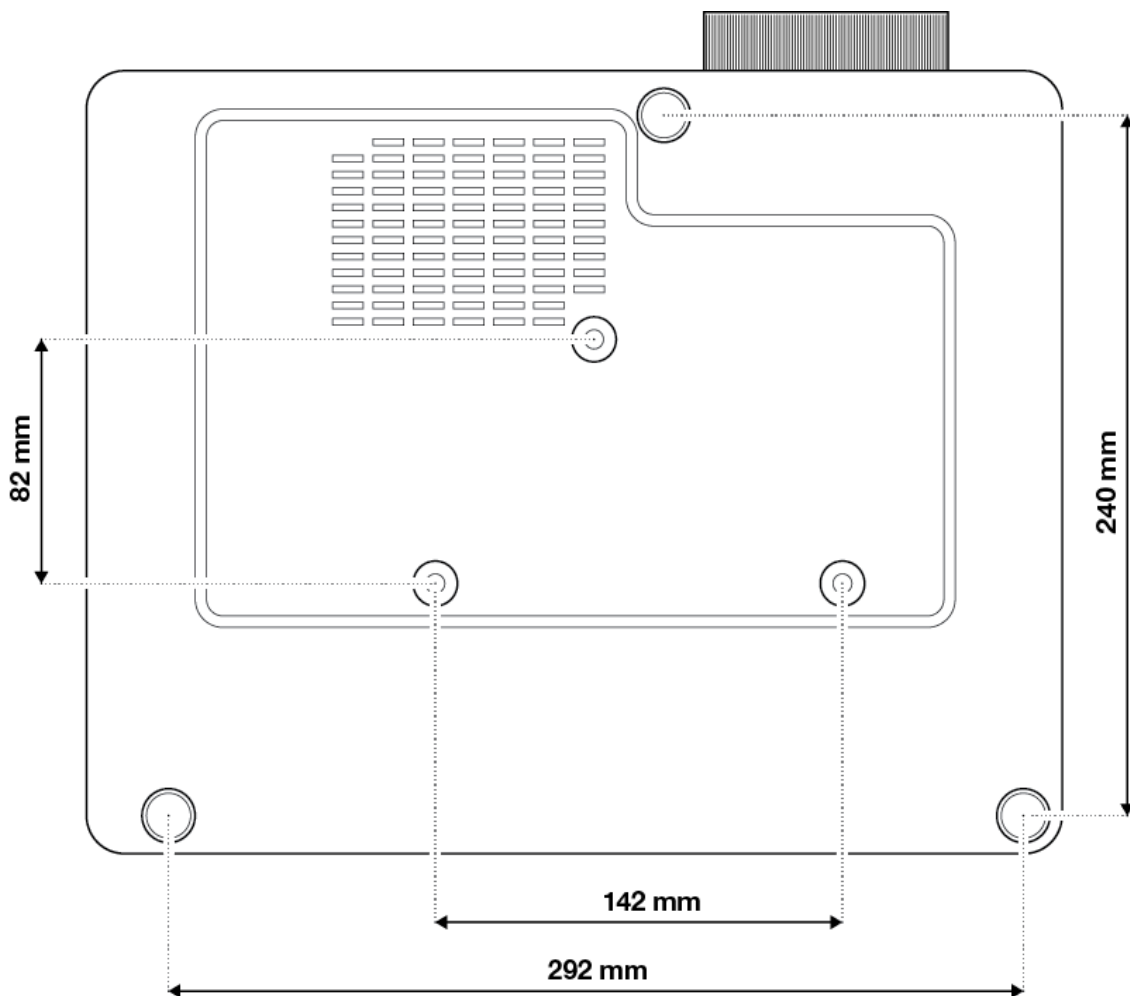

If you buy a ceiling mount from another company, please be sure to use the correct screw size. Screw size will vary depending on the thickness of the mounting plate.

Be sure to keep at least 10 cm gap between the ceiling and the bottom of the projector.

Avoid installing the projector near a heat source.

5. ADJUSTING

5.1 ADJUSTING THE IMAGE HEIGHT AND TILT

The projector's height and tilt can be adjusting with the tilt adjustment feet and ring.

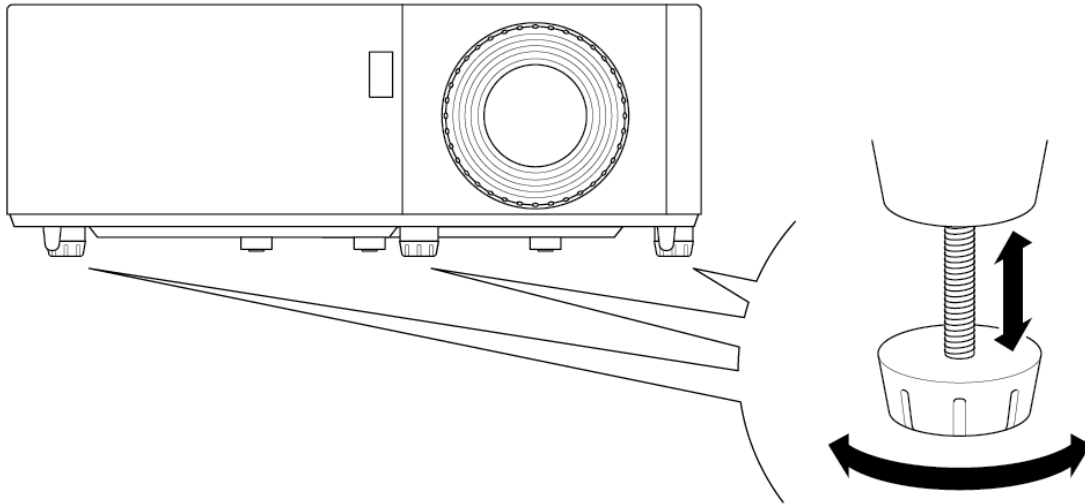

1. Locate the adjustable foot you wish to adjust on the underside of the projector.
2. Rotate the foot clockwise or counterclockwise to raise or lower the projector.

5.2 ADJUSTING THE ZOOM, LENS SHIFT, AND FOCUS



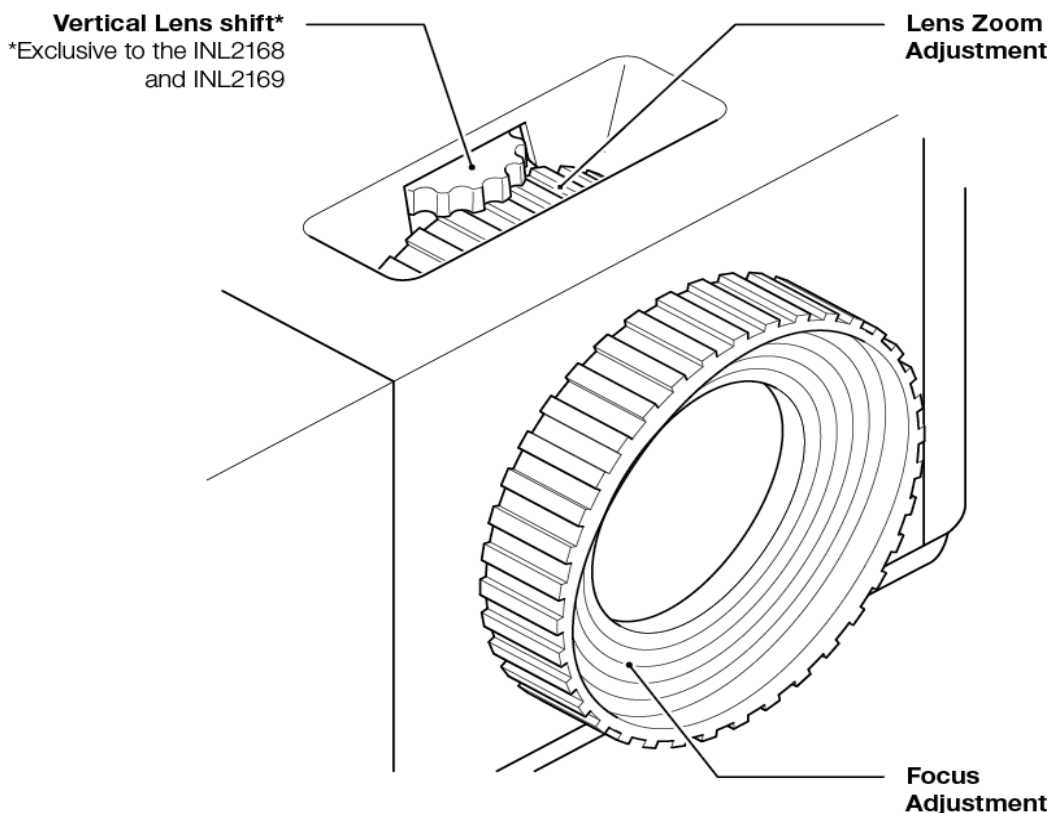

- To adjust the image size, turn the zoom ring clockwise or counterclockwise to increase or decrease the projected image size.
- To adjust the image position, turn the lens shift dial clockwise or counterclockwise to adjust the position of the projected image vertically. (Not available on all models.)
- To adjust the focus, turn the focus ring clockwise or counterclockwise until the image is sharp and legible.



5.3 ADJUSTING THE VERTICAL OR HORIZONTAL KEYSTONE

If one side of the image is shorter than the other, for example the top is shorter than the bottom, you can either reposition the projector or use keystone correction.

To adjust the top or bottom of the picture (the pitch), angle the projector lower or higher. If that is not possible, adjust the vertical keystone:

- Press the  button on the projector keypad or the **Menu** button on the remote control to open the OSD menu.
- Select **Image > V Keystone**.
- Adjust the settings by using the  keys.
- Press the  or **Enter** button to select a setting.
- Press the  or **Menu** button to close the OSD menu.
The menu will close and the projector will automatically save the new settings.

To adjust the left or right side of the picture (the yaw), turn the projector slightly left or right. If that is not possible, adjust the horizontal keystone:

- Press the  button on the projector keypad or the **Menu** button on the remote control to open the OSD menu.
- Select **Image > H Keystone**.

- Adjust the settings by using the ◀▶ keys.
- Press press the ← or **Enter** button to select a setting.
- Press the ☰ or **Menu** button to close the OSD menu.

The menu will close and the projector will automatically save the new settings.

NOTICE

Ensure that the projection screen or projection surface is within the required distance from the projector. Refer to “4.3 Placement distance from screen” for more information.

6. CONNECTING

6.1 CONNECTION DIAGRAM

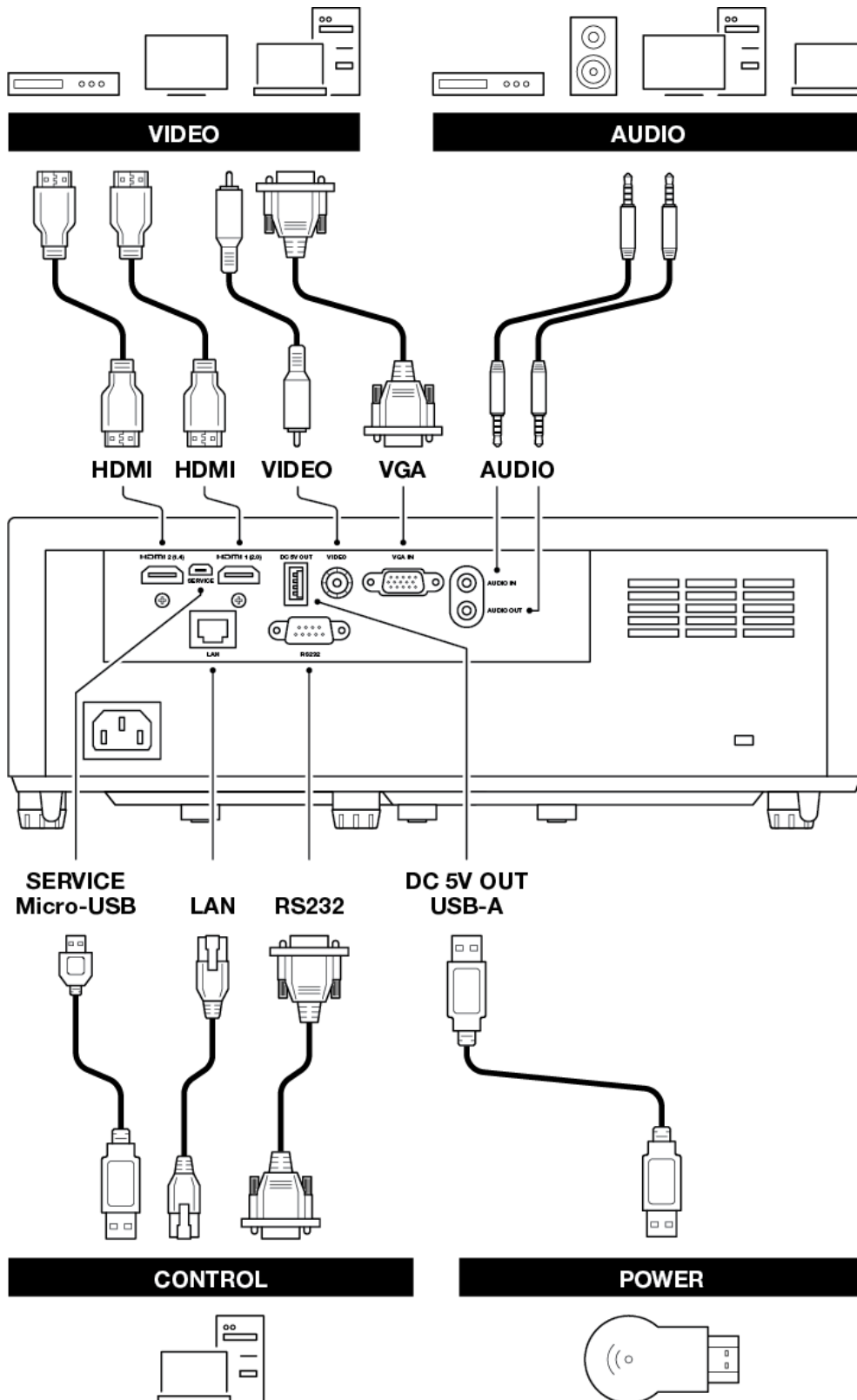

7. USING

7.1 LEDS

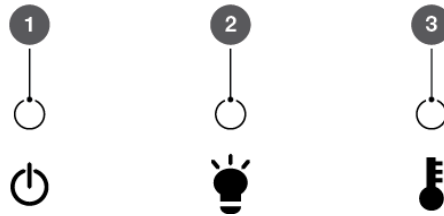

- ① Power
- ② Laser
- ③ Temperature

7.2 KEYPAD

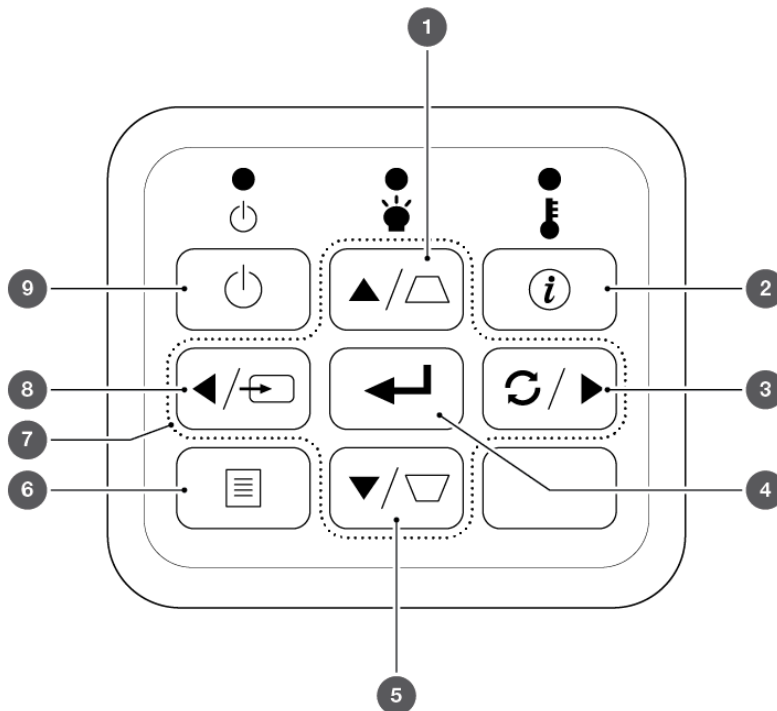

- ① Up / Keystone correction +
- ② Information
- ③ Right / Re-sync
- ④ Enter
- ⑤ PowerDown / Keystone correction -
- ⑥ Menu
- ⑦ Directional arrows
- ⑧ Left / Source
- ⑨ Power

7.3 REMOTE CONTROL

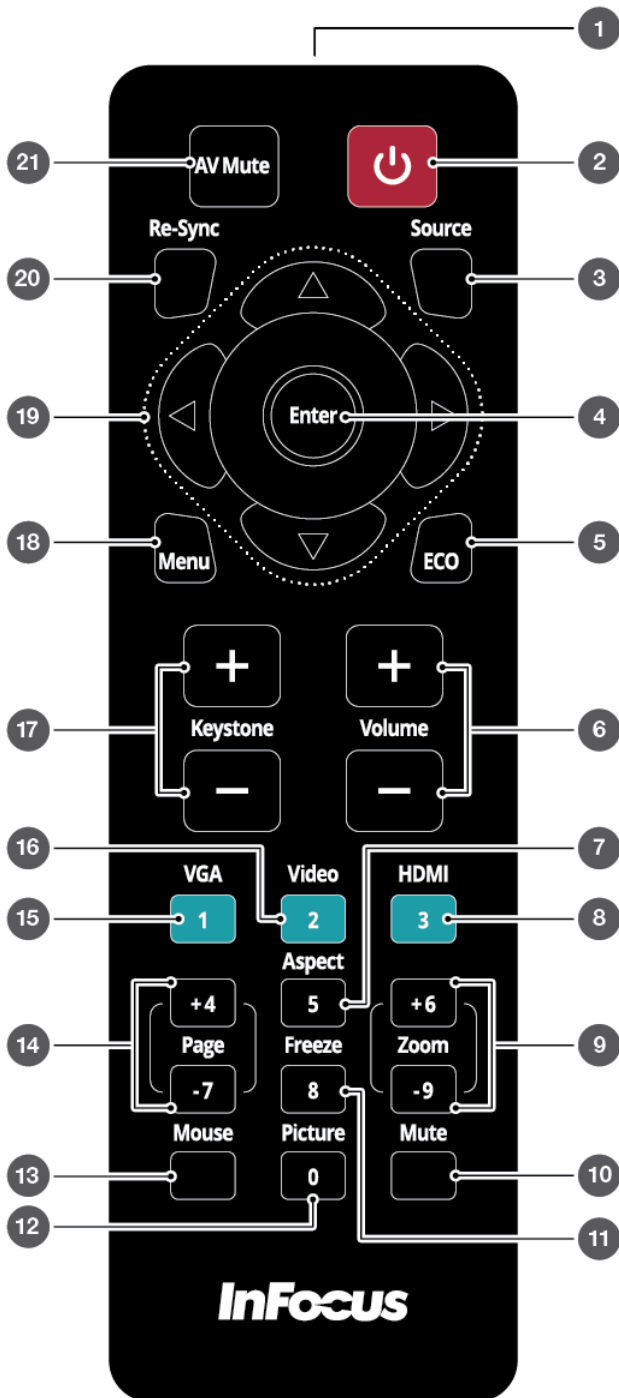

- ① IR LED
- ② Power
- ③ Source
- ④ Enter
- ⑤ ECO
- ⑥ Volume
- ⑦ Aspect
- ⑧ HDMI - Press once for HDMI 1 and twice for HDMI 2
- ⑨ Zoom
- ⑩ Mute
- ⑪ Freeze
- ⑫ Picture
- ⑬ Mouse
- ⑭ Page
- ⑮ VGA
- ⑯ Video
- ⑰ Keystone correction
- ⑱ Menu
- ⑲ Directional keys
- ⑳ Re-sync
- ㉑ AV Mute

NOTICE

Some keys may have no function for models that do not support the key's feature.

7.3.1 INSTALLING BATTERIES IN THE REMOTE CONTROL

The remote requires two AAA batteries (not included).

1. Remove the battery cover on the back of the remote control.

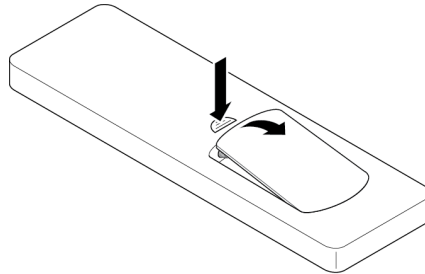

2. Insert AAA batteries in the battery compartment. Ensure each battery's polarity (+/-) is aligned correctly.

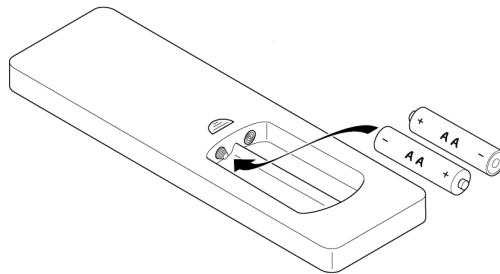

3. Replace back cover on the remote control and press down until it clicks in to place.

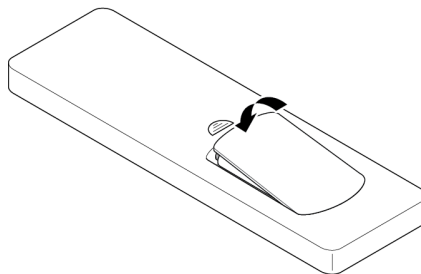

⚠ CAUTION

The remote control may fail to operate if the infrared remote sensor is exposed to bright sunlight or fluorescent lighting.

Incorrect battery usage may cause leakage of battery fluid and battery rupture, which could result in fire, injury or corrosion of the remote. When replacing batteries, take the following precautions.

- Do not use batteries of different types or mix old and new batteries.
- Remove the batteries if you will not be using the projector for a long period of time.
- Do not expose batteries to heat or flame and do not put them in water.
- Dispose of used batteries according to local regulations.
- Keep batteries out of the reach of children. Batteries are choking hazards and are very dangerous if swallowed.

7.4 REMOTE EFFECTIVE RANGE

You can locate the infrared (IR) remote control sensors on the top of the projector next to the keypad and on the front to the left of the lens. Hold the remote control at an angle within 60 degrees perpendicular of the projector's IR remote control sensor. Ensure that there are no obstacles between the remote control and the IR sensor on the projector.

The distance between the remote control and the IR sensor should be less than 12 meters (39.4 feet). If the remote control is less than 20cm (8 inches) from the IR sensor, the remote control might become ineffective. The effective range is approximately 5 meters (16.4 feet) when reflecting the IR beam using a screen. The range will depend on the screen's surface and reflectivity. Direct sunlight or florescent lamps can reduce the range of the remote control.

7.5 TURNING THE PROJECTOR ON

1. Securely connect the mains cable to the projector and to a mains outlet. When connected, the Power LED will turn red.

⚠ WARNING

Make sure that people cannot step on any electrical cables or trip over the cables. Do not put objects on the cables.

2. Connect a signal/source cable to a source device and the projector.
3. Remove the lens cap.
4. Press the **Power** button  on the keypad or remote control.

The InFocus start up screen will appear after approximately 10 seconds. The Power LED will flash blue and then steady blue.

7.6 SELECTING AN INPUT SOURCE

TIP Your projector has a Direct Power On setting. This setting will automatically turn on the projector when a power source is connected. To turn on this feature, press the **Menu** button on the remote control or keypad, navigate to **Settings > Power Settings > Direct Power On**, and select **On**.

1. Turn on the connected source, such as a computer or DVD player, or connect a digital media player, such as a Google Chromecast.
2. Press the **Source** button on the keypad or remote control to select the input source.
3. Play the content on the source device.

7.7 TURNING THE PROJECTOR TO STANDBY MODE

TIP You can set up the projector to automatically detect an active source and turn itself on and project the source content automatically. To turn on this feature, press the **Menu** button on the remote control or keypad, navigate to **Settings > Power Settings > Signal Power**, and select **On**.

1. Press the **Power** button  on the keypad or remote control.

The following message will appear: Power Off?

2. Press the **Power** button  again to confirm turning off your projector.

If the Power button is not pressed a second time, the message will disappear after 10 seconds and the projector will not turn off.

The cooling fans will operate for about 10 seconds and the Power LED will flash blue. When the Power LED changes to solid red, the projector has entered standby mode.

3. Replace the lens cap.

NOTICE

If you want to turn the projector on again, wait 100 seconds.

Always allow the projector fan to turn off after you power down and before you unplug the projector power cable from the electrical outlet.

7.8 VIEWING 3D CONTENT

Please follow all warnings and precautions as recommended before you or your child use the 3D function of this projector and view 3D projected content.

⚠ WARNING

Children and teenagers may be more susceptible to health issues associated with viewing in 3D and should be closely supervised when viewing 3D content.

7.8.1 PHOTOSENSITIVE SEIZURE WARNING AND OTHER HEALTH RISKS

- Some viewers may experience an epileptic seizure or stroke when exposed to specific flashing images or lights contained in certain Projector pictures or video games. If you suffer from or have a family history of epilepsy or strokes, please consult with a medical specialist before using the 3D function.
- Even those without a personal or family history of epilepsy or stroke may have an undiagnosed condition that can cause photosensitive epileptic seizures.
- We recommend that the projectors 3D functionality not be used by pregnant women, sufferers of serious medical conditions, persons who are sleep-deprived or under the influence of alcohol.

- If you experience any of the following symptoms, stop viewing 3D content immediately and consult a medical specialist: (1) altered vision; (2) lightheadedness; (3) dizziness; (4) involuntary movements such as eye or muscle twitching; (5) confusion; (6) nausea; (7) loss of awareness; (8) convulsions; (9) cramps; or (10) disorientation. Children and teenagers may be more likely than adults to experience these symptoms. Parents should monitor their children and ask whether they are experiencing these symptoms.
- Watching 3D projected content may also cause motion sickness, perceptual aftereffects, disorientation, eye strain, and decreased postural stability. Users should take frequent breaks to lessen the potential of these effects. If you have any of the above symptoms, immediately discontinue using this device and do not resume using it for at least thirty minutes after the symptoms have subsided.
- Watching 3D projected content while sitting too close to the screen for an extended period may damage your eyesight. The ideal viewing distance should be at least three times the screen height. We recommend that the viewer's eyes are level with the screen.
- Watching 3D projected content while wearing 3D glasses for an extended period may cause headaches or fatigue. If you experience a headache, tiredness or dizziness, stop viewing the 3D projection and rest.
- Do not use 3D glasses for any other purpose than for watching 3D projected content.
- Wearing the 3D glasses for any other purpose (such as spectacles, sunglasses, protective goggles, etc.) may be physically harmful to you and weaken your eyesight.
- Viewing 3D projected content may cause disorientation for some viewers. Accordingly, DO NOT place your 3D projector near open stairwells, cables, balconies, or other objects that can be tripped over, run into, knocked down, broken or fallen over.

7.8.2 ENABLING 3D MODE

To enable 3D mode, the input frame rate should be set to 60Hz. Other frame rate are not supported. For the best 3D performance, use a resolution of 1920x1080. 4K (3840x2160) resolution is not supported in 3D mode.

1. Select **Display > Display Mode > 3D > 3D Mode**.
2. Select **On**.

If the 3D Mode is set to Off, the 2D-3D and 3D sync Invert functions will not be selectable. These functions can only be selected if the 3D mode is set to On.

3. Press **Enter**.
4. if you only want to view the left or right frame:
 - Select **Display > Display Mode > 3D > 3D-2D**.
 - Select **L** (left) or **R** (right).
 - Press **Enter**.

5. If you want to turn off the 3D sync invert function:

- Select **Display > Display Mode > 3D > 3D Sync Invert**.
- Select **Off**.
- Press **Enter**.

7.8.3 ENABLING AUTO 3D MODE

3D Auto mode can be enabled for HDMI 2 connections only.











1. Select **Display > Display Mode > 3D > 3D Format**.
2. Select **Auto**.

Other options:

- **SBS**: Display 3D signal in “Side-by-Side” format.
 - **Top and Bottom**: Display 3D signal in “Top and Bottom” format.
 - **Frame Sequential**: Display 3D signal in “Frame Sequential” format.
3. Press **Enter**.

8. USING THE ON SCREEN DISPLAY (OSD) MENU

The multilingual On Screen Display (OSD) menu can be used to setup and adjust the projector.

1. Press the  button on the projector keypad or the **Menu** button on the remote control.
2. When the menu appears, use the   keys to select an item.
3. Press the  button on the projector keypad or the **Enter** button on the remote control to open a submenu.
4. Use the   keys to select an item in a submenu and the  or **Enter** button to view additional settings.
5. Adjust the settings by using the   keys.
6. Press the  or **Enter** button to select a setting.
7. To close the OSD menu, press the  or **Menu** button.
The menu will close and the projector will automatically save the new settings.

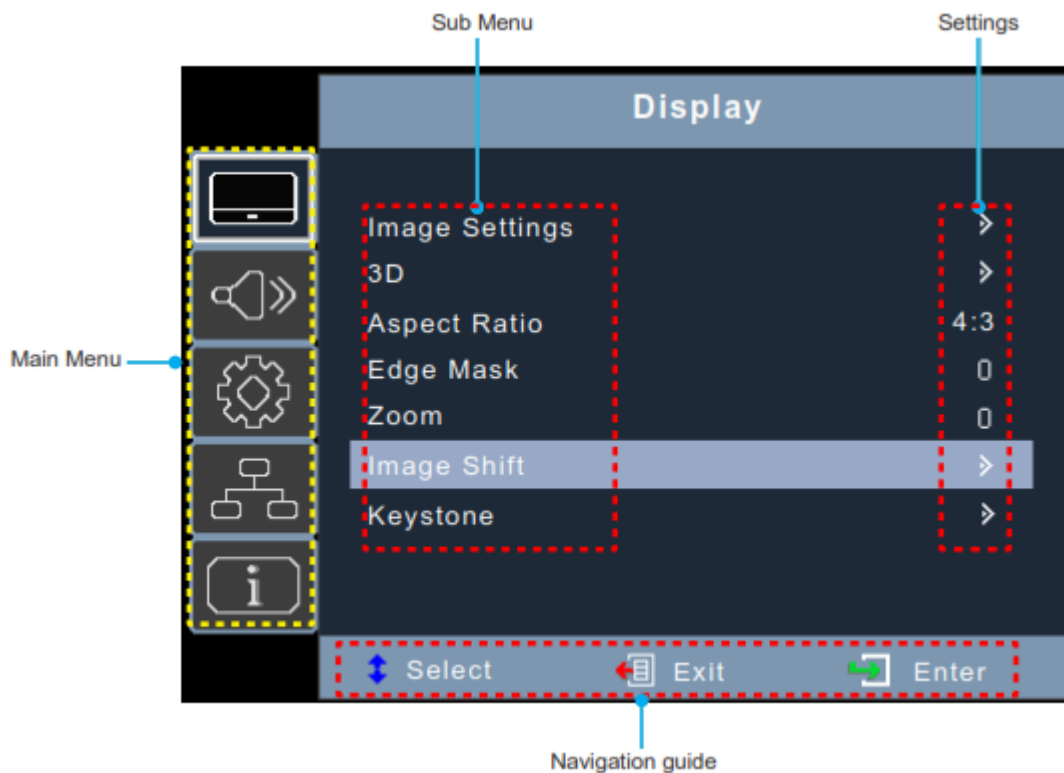

The OSD menus are listed in the "On Screen Display (OSD) Menu Tree" section.

8.1 SELECTING THE LANGUAGE FOR THE ON SCREEN MENU

1. Select **Setup** > **Options** > **Language**
2. Select a language.
3. Press **Enter**.

8.2 SELECTING A DISPLAY MODE

TIP The display settings are only visible when an active source is connected to the projector.

1. Select **Display** > **Image Settings** > **Display Mode**.
2. Select a display mode:
 - **Presentation**: Suitable for giving presentations using a PC.
 - **Bright**: The brightest possible setting when using a PC.
 - **HDR SIM.**: Decodes and displays High Dynamic Range (HDR) content for the deepest blacks, brightest whites, and vivid cinematic colour using the REC.2020 colour gamut. This mode will be automatically enabled if HDR content is sent to projector (4K UHD Blu-ray, 1080p/4K UHD HDR/HLG games, or 4K UHD streaming video). While HDR mode is active, other display cannot be selected as HDR delivers colour that is highly accurate and exceeds the colour performance of the other display modes. HDR mode can also be manually selected for use with non HLG content for simulation effect.
 - **HLG SIM.**: Decodes and displays Hybrid Log Gamma (HLG) content for the deepest blacks, brightest whites, and vivid cinematic colour using the REC.2020 colour gamut. This mode will be automatically enabled if HLG content is sent to projector (4K UHD Blu-ray, 1080p/4K UHD HDR/HLG games, or 4K UHD streaming video). HLG mode can also be manually selected for use with non HLG content for simulation effect.
 - **Cinema**: Provides the best colour reproduction for watching movies.
 - **Game**: Increases the brightness and decreases the response time for playing video games with minimal lag.
 - **sRGB**: Standardized accurate colour reproduction.
 - **DICOM SIM.**: Simulation mode for viewing monochrome images such as X-rays.
 - **User**: Saved user settings.
 - **3D**: To experience 3D, you will need 3D glasses and a video source that is capable of sending 3D content.
3. Press **Enter**.

8.3 ADJUSTING THE IMAGE COLOUR TEMPERATURE

TIP The Display settings are only visible when an active source is connected to the projector.

1. Select **Display > Image Settings > Color Settings > Color Temperature**.
2. Select a value.
3. Press **Enter**.

8.4 ADJUSTING THE SHARPNESS

1. Select **Display > Image Settings > Color**.
2. Press **Enter**.

8.5 MAGNIFYING THE IMAGE

1. Select **Display > Zoom**.
2. Press **Enter**.

8.6 SELECTING AN ASPECT RATIO

1. Select **Display > Aspect Ratio**.
2. Select an aspect ratio.
3. Press **Enter**.

8.7 ADJUSTING THE BRIGHTNESS

1. Select **Display > Image Settings > Brightness Mode**.
2. Select a brightness mode.
3. Press **Enter**.

8.8 ENABLING ECO MODE

1. Select **Display** > **Image Settings** > **Brightness Mode**.
2. Select **Eco**.
3. Press **Enter**.

8.9 ENABLING CLOSED CAPTIONS

1. Select **Setup** > **Options** > **Closed Caption**.
2. Select **CC1** or **CC2**.
3. Press **Enter**.

8.10 DISPLAYING A TEST PATTERN

1. Select **Setup** > **Test Pattern**.
2. Select a test pattern.
3. Press **Enter**.

8.11 PREVENTING UNAUTHORIZED USE

1. Select **Setup** > **Security** > **Security**.
2. Select **On**.
The default password is 1234.
3. Press **Enter**.

8.12 CHANGING THE PASSWORD

1. Select **Setup** > **Security** > **Change Password**.
2. Type the new password.
3. Press **Enter**.

NOTICE

Do not lose the password. The password can only be reset at an authorized InFocus repair facility.

8.13 CONTROLLING THE PROJECTOR FROM A WEB BROWSER

1. Connect the projector to an active network port using the RJ45 port on the back of the projector.
2. Select **Network** > **LAN** > **DHCP**.
3. Select **On**.
4. Press **Enter**.
5. Select **Network** > **LAN** > **IP Address** to view the projector's IP address.
6. Open a web browser.
7. Type the projector's IP address type the user name and password.
The default user name and password is **admin**.
8. Click **Login**.
The projector's configuration page appears.

9. Select the Projector Control tab.

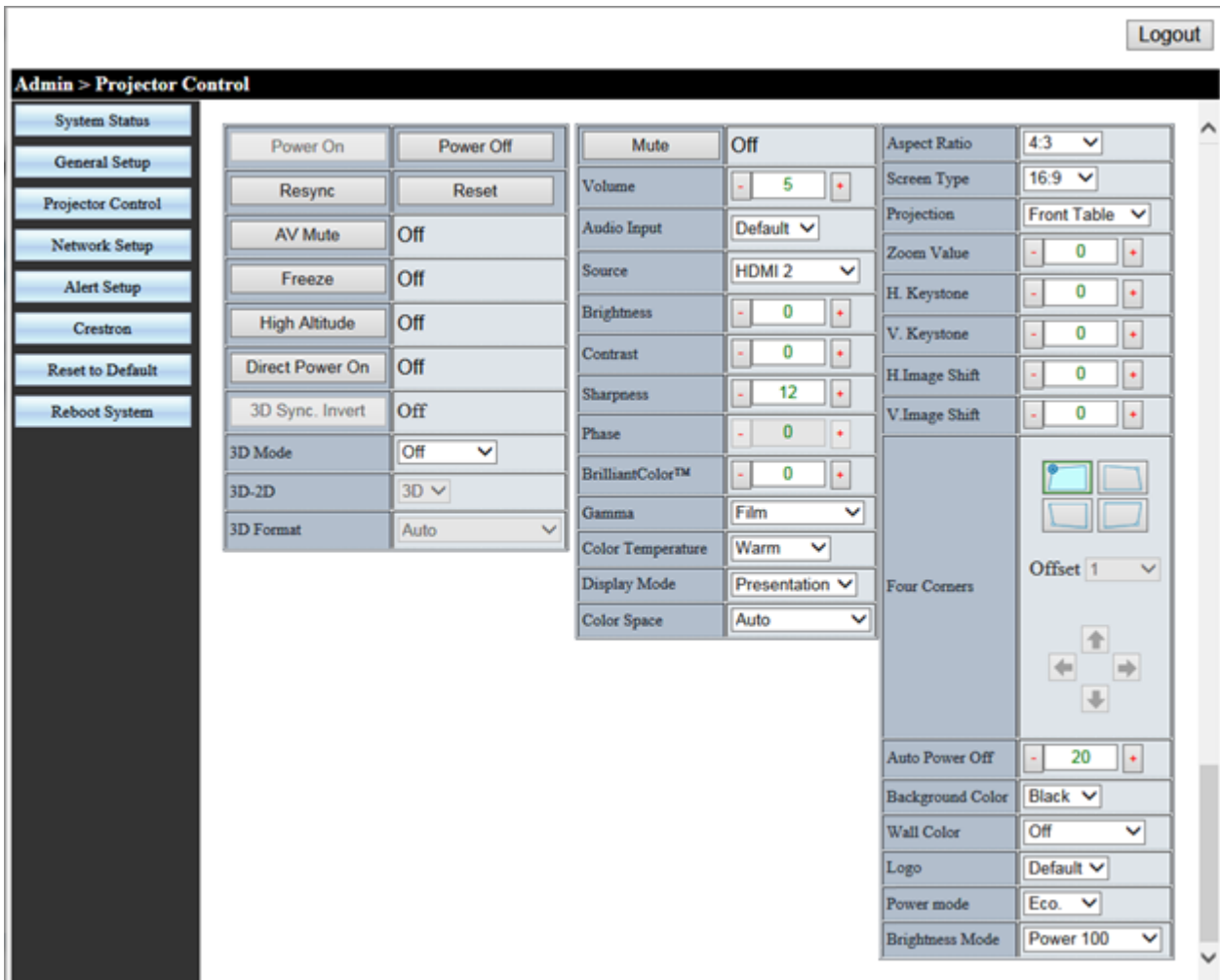

8.14 DIRECTLY CONNECTING A COMPUTER TO THE PROJECTOR

1. Select Network > LAN > DHCP.
2. Select Off.
3. Press Enter.
4. Select Network > LAN.
5. Configure the IP address, Subnet Mask, Gateway, and DNS settings.
6. Set the computer to use the same IP address, subnet mask, gateway, and DNS settings.
7. Open a web browser.
8. Type the projector's IP address type the user name and password.
The default user name and password is **admin**.

9. CLEANING

⚠ WARNING

Do not use canned air or any type of abrasive pad, paper towel, scouring powder, glass cleaner, or solvent (such as alcohol, paint thinner or benzene).

Unplug the projector before cleaning.

9.1 CLEANING THE LENS

Clean the projector's lens with a lightly damp cloth. Do not spray liquid directly onto the lens.

9.2 CLEANING THE CASE

Clean the projector's case using a lightly damp cloth.

9.3 CLEANING THE AIR INTAKE VENTS

Clean the air intake vents with a soft and dry cloth, a soft brush, or a small vacuum cleaner designed for cleaning electrical devices.

10. SANITATION

- Using only lightly dampened microfibre cloth to avoid malfunction and possible permanent damage to electronic parts, lightly clean the surface of the product, avoiding any connection points, ventilation holes or the lens.
- After the application, dry the product with a clean and dry microfibre cloth.

Please follow all safety and handling instructions listed with the cleaning solution and keep out of reach of children.

For schools conducting an overall deep clean of their facilities, here are steps to appropriately protect your InFocus product in advance of chemicals being sprayed or fogging devices being employed:

- Disconnect the product from its power source.
- Cover the product to prevent damage to internal electronic components.
- Remember to remove any covering before use.
- Please ensure that those with access to your InFocus products are aware of the cleaning procedure.

⚠ CAUTION

Ensure your InFocus product is fully covered on all sides before facilities deep cleaning. Chemicals must not be allowed to enter or be sprayed on to the surface of the product, this will avoid any damage to the internal electronic components and outer casing parts.

Good personal hygiene practices of washing and drying hands should be employed before and after use of InFocus products.

Should you have any questions relating to these procedures please contact InFocus Technical Support. Contact details can be found in the products users guide and at infocus.com/support.

11. DISPOSAL

11.1 DISPOSAL OF ELECTRONIC COMPONENTS

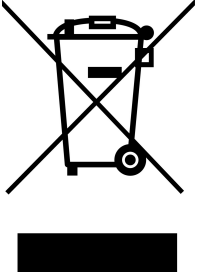

The symbol on the product, the accessories or packaging indicates that this device shall not be treated as unsorted municipal waste, but shall be collected separately. Dispose of the device via a collection point for the recycling of waste electrical and electronic equipment if you live within the EU and in other European countries that operate separate collection systems for waste electrical and electronic equipment. By disposing of the device in the proper manner, you help to avoid possible hazards for the environment and public health that may otherwise be caused by improper treatment of waste equipment. The recycling of materials contributes to the conservation of natural resources.

11.2 DISPOSAL OF PACKAGING WASTE

The packaging is made of environmentally friendly materials, which may be disposed of through your local recycling facilities. By disposing of the packaging and packaging waste in the proper manner, you help to avoid possible hazards for the environment and public health.

12. TROUBLESHOOTING

12.1 LED INDICATOR LIGHTS

The following table describes the LED indicator light colors and their meaning.

LED	Indicator	Meaning
Power	Blue solid	Normal operation.
	Blue flashing	The projector is warming up, shutting down, or cooling down. The remote control may be disabled while the indicator is flashing blue.
	Red solid	Standby mode.
	Off	Off or Sleep mode.
Laser	Red flashing	Laser failure.
Temperature	Red flashing	Fan failure .
	Red solid	Over temperature.

The projector will automatically shutdown if there is a laser failure, a fan failure or if the projector has overheated. Unplug the power cable from the projector, wait 30 seconds, and try again. If the warning indicators light up or flash, contact your nearest service center for assistance.

12.2 SOLVING ON/OFF ISSUES

The following table provides solutions for potential issues that may occur when the projector is turned on or off.

Issue	Cause	Solution
Projector will not turn on.	No power.	Check that the power cable is connected. Check that the and that the power indicator is on.
	The projector has overheated.	Make sure there is at least 30cm of clearance around the intake and exhaust vents. Wait five minutes and try turning the projector on again. If the projector is being used above 5500 ft/1600 m, use the On Screen Display (OSD) menu to set High Altitude to on.
Projector turns off by itself.	The Auto Power Off timer is set.	Use the On Screen Display (OSD) menu to adjust the auto power of setting.

12.3 SOLVING IMAGE ISSUES

The following table provides solutions for potential image issues.

Issue	Cause	Solution
No image.	Incorrect source is selected.	Press the SOURCE button or one of the source buttons again.
	Source cable is not connected.	Ensure the source cable is securely connected to the projector and source device.
	Source is not playing	Make sure the source has not stopped or paused the video. If the source is a computer, make sure the PC is not in a screen saving or power saving mode and resend the video to the projector.
	AV-Mute is on.	Ensure the AV-MUTE (video off) buttons has not been pressed.
	Brightness and/or contrast setting is too low.	Use the On Screen Display (OSD) menu to adjust the brightness and contrast.
Image is reversed.	Orientation is set incorrectly.	Use the On Screen Display (OSD) menu to adjust the orientation.
Image has slanted sides .	Projector is not positioned perpendicularly to the screen.	Ensure the projector is centered on the screen and below the bottom of the screen.
	Keystone is not set correctly.	Press the keystone + or - buttons to adjust the image alignment.
Image is too small or too large.	Projector is too far from or too close to the screen.	Move the projector.
	The zoom is not set correctly.	Press the Zoom + or - buttons to adjust the zoom.
Image is too dark.	ECO mode is enabled.	Check if the projector is in the Forced ECO mode because the ambient temperature is too high.
Image is blurry.	Focus is not set correctly.	Use the On Screen Display (OSD) menu to adjust the focus. INL2156 or INL2166: Use the focus ring to adjust the focus.
	Projector is too close or too far from the screen.	Ensure that the distance between the projector and screen is within the adjustment range of the lens.
	Smudge or condensation on the lens.	Clean the lens. Condensation may form on the lens if the projector is cold, brought into a warm place, and turned on.
Image is scrolling or flickering.	Source resolution and/or frequency is not supported.	Make sure that the source's resolution and frequency are supported by the projector.

12.4 SOLVING VIDEO, AUDIO, AND REMOTE CONTROL ISSUES

The following table provides solutions for potential video, audio, and remote control issues.

Issue	Cause	Solution
Video is frozen.	The Freeze button has been pressed.	Press the Freeze button on the remote to unfreeze the video.
Video is stretched.	16:9 (wide) source is setup incorrectly.	Ensure the source is set to use the 16:9 (wide) display format.
	Letterbox (LBX) source is setup incorrectly.	Use the On Screen Display (OSD) menu to set the aspect ratio to LBX.
	4:3 source is setup incorrectly.	Use the On Screen Display (OSD) menu to set the aspect ratio to 4:3.
No audio.	Projector is muted.	Press the Mute button to unmute the projector.
	Volume setting is too low.	Press the volume + button to increase the volume.
	Source cable is not connected.	Ensure the source cable is securely connected to the projector and source device.
	Source is muted.	Ensure the source has not been muted.
Remote does not work.	Batteries expired.	Install new batteries.
	Batteries installed incorrectly.	Remove and reinstall the batteries.
	Remote is too far from projector.	The remote should be within 16.4 feet (5m) of the projector.
	IR receiver cannot detect remote.	<p>Ensure there are no obstructions between the remote and the projector's IR receiver.</p> <p>Ensure the operating angle of the remote control is within $\pm 20^\circ$ to the projector's IR receiver.</p> <p>Ensure there are no fluorescent light sources shining on the projector's IR receiver.</p>

If you are still experiencing technical issues with your projector, please contact InFocus Customer Support at www.infocus.com/support.

12.5 REPAIR BY SKILLED PERSONS

Servicing is required when the projector has been damaged, exposed to rain or moisture, does not operate normally, or has been dropped. All servicing and repairs should be performed by an authorized InFocus representative.

13. ADDITIONAL INFORMATION

13.1 RS232 PIN ASSIGNMENTS

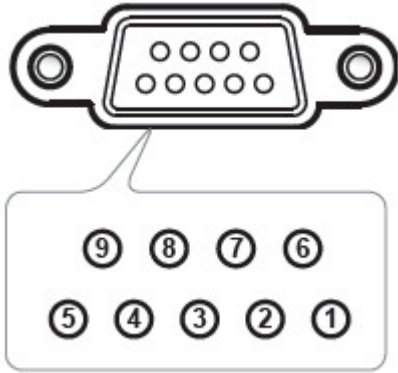

Pin No.	Descriptor Timing -B0 (Detail Timing)
1	N/A
2	RXD
3	TXD
4	N/A
5	GND
6	N/A
7	N/A
8	N/A
9	N/A

13.2 RS232 PROTOCOL FUNCTION LIST

Function	Value
Baud rate	19200
Parity bit	None
Data bit	8
Stop bit	1
Laser on delay	20s
Power down delay	20s
Source change delay	8s
Intercommand delay minimum	500ms
Intercharacter delay minimum	2ms

A complete list of RS232 commands and controls for your networkable product can be located on the Product Series landing page for your product under the “Downloads:” section.

13.3 SUPPORTED RESOLUTIONS AND REFRESH RATES

COMPUTER

Signal	Resolution	Refresh Rates (Hz)	Mac OS Refresh Rates (Hz)
VGA	640 x 480	60 / 67 / 72 / 85 / 120**	60 / 72 / 85
SVGA	800 x 600	56 / 60** / 72 / 85 / 120**	60 / 72 / 85
XGA	1024 x 768	60** / 70 / 75 / 85 / 120**	60 / 70 / 75 / 85
HDTV (720P)	1280 x 720	50 / 60**	60
WXGA	1280 x 768	60 / 75 / 85	60 / 75 / 85
	1280 x 800	60 / 120**	60
WXGA	1366 x 768	60	
SXGA	1280 x 1024	60 / 75 / 85	60 / 75
SXGA+	1400 x 1050	60	
UXGA	1600 x 1200	60	
HDTV (1080p)	1920 x 1080	24 / 50 / 60	60
WUXGA	1920 x 1200*	60	60
	720 x 400	70	
	832 x 624	75	75
	1152 x 870	75	75

* 1920 x 1200 @60Hz only support RB (reduced blanking) ** Support 3D timing for True 3D projector (Option)

HDMI

Signal	Resolution	Refresh Rates (Hz)	Mac OS Refresh Rates (Hz)
VGA	640 x 480	60 / 120**	60 / 72 / 85
SVGA	800 x 600	60** / 72 / 85 / 120**	60 / 72 / 85
XGA	1024 x 768	50/60** / 70 / 75 / 85 / 120**	60 / 70 / 75 / 85
SDTV (480I)	720 x 480	60	
SDTV (480P)	720 x 480	60	
SDTV (576I)	720 x 576	50	
SDTV (576P)	720 x 576	50	
WSVGA (1024X600)	1024 x 600	60	
HDTV (720p)	1280 x 720	50** / 60**	60
WXGA	1280 x 768	60 / 75 / 85	75
	1280 x 800	60 / 120**	60
WXGA	1366 x 768	60	
WXGA+	1440 x 900	60	
SXGA	1280 x 1024	60 / 75 / 85	60 / 75
SXGA+	1400 x 1050	60	
UXGA	1600 x 1200	60	
HDTV (1080I)	1920 x 1080	50 / 60	
HDTV (1080p)	1920 x 1080	24 / 30 / 50 / 60	60
WUXGA	1920 x 1200*	60	60
UHD (2160p)	3840 x 2160	24*** / 25*** / 30*** / 50 / 60	
4K2K (2160p)	4096 x 2160	24*** / 25 / 30 / 50 / 60	

* 1920 x 1200 @60Hz only support RB (reduced blanking) ** 3D timing for True 3D projector (Option) *** HDMI1 UHD / 4K2K timing only support

3D

HDMI 3D Input	Input Timing		
With 3D InfoFrame information	1280 X 720P @ 50Hz	Top - and - Bottom	
	1280 X 720P @ 60Hz	Top - and - Bottom	
	1280 X 720P @ 50Hz	Frame packing	
	1280 X 720P @ 60Hz	Frame packing	
	1920 X 1080i @50 Hz	Side- by-Side (Half)	
	1920 X 1080i @60 Hz	Side- by-Side (Half)	
	1920 X 1080P @24 Hz	Top - and - Bottom	
	1920 X 1080P @24 Hz	Frame packing	
Without 3D InfoFrame information	1920 x 1080i @ 50Hz 1920 x 1080i @ 60Hz 1280 x 720P @50Hz 1280 x 720P @60Hz	Side-by-Side(Half)	SBS mode is on
	1920 x 1080i @ 50Hz 1920 x 1080i @ 60Hz 1280 x 720P @50Hz 1280 x 720P @60Hz	Top-and-Bottom	TAB mode is on
	480i	HQFS (3D format is Frame sequential)	

NOTICE

If 3D input is 1080p@24hz, the DMD should replay with integral multiple with 3D mode.

1080i@25hz and 720p @ 50hz will run in 100 Hz. Other 3D timing will run in 120 Hz.

1080P @ 24hz will run 144Hz (XGA, WXGA, 1080p) / 96Hz (WUXGA).

13.4 ON SCREEN DISPLAY (OSD) MENU TREE

DISPLAY MENU

Level 1 (Sub)	Level 2 (Sub)	Level 3 (Sub)	Level 4 (Sub)	Data		Remark		
				Default	Value			
Image Settings	Display Mode			By Color Table	Presentation			
					Bright			
					HDR SIM.	1. SIM. = simulate 2. Simulated high dynamic range with HDR or non-HDR content 3. Auto select this mode in HDR signal		
					HLG SIM.	1. SIM. = simulate 2. Simulated high dynamic range with HLG or non-HLG content 3. Auto select this mode in HLG signal		
					Cinema			
					Game			
					sRGB			
					DICOM SIM.	1. SIM. = simulate 2. Simulate a monochrome medical image content		
					User			
					3D			
	Wall Color				@	Off		
						Blackboard		
						Light Yellow		
						Light Green		
						Light Blue		
						Pink		
	Brightness				By Color Table			
							-50 ~ 50	
							-50 ~ 50	
							1 ~ 15	
							-50 ~ 50	Gray out in RGB signal
	Contrast				By Color Table			
							-50 ~ 50	Gray out in RGB signal
	Sharpness				By Color Table			
							-50 ~ 50	Gray out in RGB signal
	Color				By Color Table			
							-50 ~ 50	Gray out in RGB signal
	Tint				By Color Table			
							-50 ~ 50	Gray out in RGB signal
	Gamma				By Color Table	Film	Film: for home theater and gamma curve like 2.2	
Video						Video: for video or TV source and gamma curve like 1.8		
Graphics						Graphics: for PC / Photo source and gamma curve like 1.0		
Standard (2.2)								
1.8								
2.0								
2.4								
2.6								

Level 1 (Sub)	Level 2 (Sub)	Level 3 (Sub)	Level 4 (Sub)	Data		Remark	
				Default	Value		
Image Settings	Color Settings	BrilliantColor™		By Color Table	1 ~ 10		
		Color Temperature		By Color Table	Warm	5500K	
					Standard	6500K	
					Cool	7500K	
					Cold	8300K	
		Color Matching	Color		Red	Red / Green / Blue / Cyan / Yellow / Magenta / White (*)	
			Hue / R (*)			-50 ~ 50	1. Hue for Color of Red, Green, Blue, Cyan, Yellow and Magenta 2. R for Color of White
			Saturation / G (*)			-50 ~ 50	1. Saturation for Color of Red, Green, Blue, Cyan, Yellow and Magenta 2. G for Color of White
			Gain / B (*)			-50 ~ 50	1. Gain for Color of Red, Green, Blue, Cyan, Yellow and Magenta 2. B for Color of White
			Reset				
			Exit				
		RGB Gain/Bias	Red Gain		By Color Table	-50 ~ 50	
			Green Gain			-50 ~ 50	
			Blue Gain			-50 ~ 50	
			Red Bias			-50 ~ 50	
			Green Bias			-50 ~ 50	
			Blue Bias			-50 ~ 50	
			Reset				
			Exit				
		Color Space	(Non-HDMI signal)		@	Auto	
						RGB	
						YUV	
			(HDMI signal)		@	Auto	
						RGB (0~255)	
						RGB (16~235)	
		Signal	Automatic		On	Off / On	1. Gray out Signal when source is not VGA 2. On: configure automatically the signal 3. Off: Frequency, Phase, H. Position and V. Position will appear for tuning and saving the settings
			Frequency		0	-10 ~ 10	Gray out this while Automatic is On
	Phase			by signal	0 ~ 31	Gray out this while Automatic is On	
	H. Position			0	-5 ~ 5	Gray out this while Automatic is On	
	V. Position			0	-5 ~ 5	Gray out this while Automatic is On	
	Brightness Mode				DynamicBlack	1. Select modes are DynamicBlack, Eco. and Power 2. Power adjusting range from 100% to 50% 3. Power adjusting step by 5%	
					Eco.		
	Reset			@ (Power 100%)	Power 100% ~ 50%		

Level 1 (Sub)	Level 2 (Sub)	Level 3 (Sub)	Level 4 (Sub)	Data		Remark
				Default	Value	
3D	3D Mode			@	Off	Gray out 3D - 2D, 3D Format and 3D Sync Invert while 3D Mode is Off
					On	Support auto 3D On and hide 3D Format while signal is HDMI 1.4a 3D
	3D - 2D			@	3D	
					L	Only display left frame
					R	Only display right frame
	3D Format			@	Auto	
					SBS	SBS = Side by Side Half
				Top and Bottom		
				Frame Sequential		
3D Sync Invert				Off	Off / On	
Aspect Ratio					4:3	
					16:9	
					16:10	Not supported in 1080p
					LBX	1. LBX = L.Box
					Native	Original image without any scaling
				@	Auto	
Edge Mask				0	0 ~ 10	<ol style="list-style-type: none"> 1. Save value into EEPROM 2. Overscan display area 0~10% 3. Remove the video encoding noise on the edge 4. VIDEO source default is 4 5. Gray out if four corners enable
Zoom				0	-5 ~ 25	<ol style="list-style-type: none"> 1. Save value into EEPROM 2. Digital zoom from 0.8X~2.0X (-5~25) 3. Value mapping: -5 (0.8X), -4 (0.84X), -3 (0.88X), -2 (0.92X), -1 (0.96X), 0 (1.0X), 1 (1.04X), 2 (1.08X), 3 (1.12X), 4 (1.16X), 5 (1.2X), 6 (1.24X), 7 (1.28X), 8 (1.32X), 9 (1.36X), 10 (1.4X), 11 (1.44X), 12 (1.48X), 13 (1.52X), 14 (1.56X), 15 (1.6X), 16 (1.64X), 17 (1.68X), 18 (1.72X), 19 (1.76X), 20 (1.8X), 21 (1.84X), 22 (1.88X), 23 (1.92X), 24 (1.96X), 25 (2.0X) 4. Gray out if four corners enable
Image Shift	H.			0	-100 ~ 100	<ol style="list-style-type: none"> 1. Save value into EEPROM 2. Shift projected image position horizontally 3. Gray out if four corners enable
	V.			0	-100 ~ 100	<ol style="list-style-type: none"> 1. Save value into EEPROM 2. Shift projected image position vertically 3. Gray out if four corners enable
Keystone	Four Corners					
	H Keystone			0	-30 ~ 30	
	V Keystone			0	-30 ~ 30	
	Auto Keystone			On	Off / On	
	Reset					

AUDIO MENU

Level 1 (Sub)	Level 2 (Sub)	Level 3 (Sub)	Level 4 (Sub)	Data		Remark
				Default	Value	
Mute				Off	Off / On (ICON)	Show mute on icon in top-right screen
Volume				5	0 - 10	

SETUP MENU

Level 1 (Sub)	Level 2 (Sub)	Level 3 (Sub)	Level 4 (Sub)	Data		Remark
				Default	Value	
Projection				Front	Front / Rear / Ceiling-Top / Rear-Top (ICON)	
Screen Type				16:10	16:9 / 16:10	Not supported in 1080p
Power Settings	Direct Power On			Off	Off / On (ICON)	
	Signal Power On			Off	Off / On (ICON)	Only support HDMI1, HDMI2 and VGA IN (PC timing only)
	Auto Power Off (min.)			20	0 ~ 180	+/- 5 step adjustment
	Power Mode (Standby)			Eco.	Eco. / Active	1. Eco.: Reduce power dissipation (<0.5W), disable USB Power (Standby) and disable LAN function. 2. Active: Select for normal standby (>0.5W), USB Power (Standby) is available to turn on and enable LAN function (<2W).
	USB Power (Standby)			Off	Off / On (ICON)	Gray out this while Power Mode (Standby) is Eco.
Security	Security			Off	Off / On (ICON)	Password: 1234
	Security Timer	Month		0	0 ~ 12	
		Day		0	0 ~ 30	
		Hour		0	0 ~ 24	
Change Password			1234		Password is 4 digitals	
HDMI CEC	HDMI CEC			Off	Off / On (ICON)	
Test Pattern				Off	Green Grid / Magenta Grid / White Grid / White / Off	

Level 1 (Sub)	Level 2 (Sub)	Level 3 (Sub)	Level 4 (Sub)	Data		Remark	
				Default	Value		
Options	Language			@	English	English	
					Deutsch	German	
					Français	French	
					Italiano	Italian	
					Español	Spanish	
					Português	Portuguese	
					Polski	Polish	
					Nederlands	Dutch	
					Svenska	Swedish	
					Norsk/Dansk	Norwegian/Danish	
					Suomi	Finnish	
					ελληνικά	Greek	
					繁體中文	Traditional Chinese	
					簡體中文	Simplified Chinese	
					日本語	Japanese	
한국어	Korean						
Русский	Russian						
Magyar	Hungarian						
Čeština	Czechoslovak						
عربي	Arabic						
ไทย	Thai						
Türkçe	Turkish						
فارسی	Farsi						
Tiếng Việt	Vietnam						
Bahasa Indonesia	Indonesian						
Română	Romania						
Slovenčina	Slovakian						
	Closed Caption			Off	Off / CC1 / CC2	Hide this while input source is not VIDEO	
	Menu Settings	Menu Location			Top-Left (ICON)		
						Top-Right (ICON)	
			@			Center (ICON)	
						Bottom-Left (ICON)	
						Bottom-Right (ICON)	
	Menu Timer				Off		
					5 sec		
		@			10 sec		

Level 1 (Sub)	Level 2 (Sub)	Level 3 (Sub)	Level 4 (Sub)	Data		Remark
				Default	Value	
Options	Auto Source			Off	Off / On (ICON)	1. Off: only search the current input selection. Press the Source button to display a list of sources. 2. On: automatically finds an available input source. Press the Source button to automatically detect the next source. 3. Auto source scan sequence: HDMI 1 (Default)->HDMI 2->VGA IN->VIDEO
	Input Source			@	HDMI 1	
					HDMI 2	
					VGA	
					VIDEO	
	High Altitude			Off	Off / On (ICON)	
	Logo			Default	Default / Neutral	1. Default: customer logo 2. Neutral: same as below Background Color setting
	Background Color			@	Black (ICON)	
					Blue (ICON)	
					Red (ICON)	
				Green (ICON)		
				Gray (ICON)		
				Logo (ICON)	Same as above Logo setting	
Reset	Reset to Default				Cannot reset network setting and Light Source Hours	

NETWORK MENU

Level 1 (Sub)	Level 2 (Sub)	Level 3 (Sub)	Level 4 (Sub)	Data		Remark
				Default	Value	
LAN	Network Status			(DisplayOnly)	Disconnect / Connected (ICON)	
	MAC Address			(DisplayOnly)	AA : BB : CC : DD : EE : FF	
	DHCP			On	Off / On (ICON)	
	IP Address			By DHCP server	xxx.xxx.xxx.xxx	1. Gray out these while DHCP is On 2. When DHCP is Off, default IP configure setting: IP Address: 192.168.0.100 Subnet Mask: 255.255.255.0 Gateway: 192.168.0.254 DNS: 192.168.0.51
	Subnet Mask				xxx.xxx.xxx.xxx	
	Gateway				xxx.xxx.xxx.xxx	
	DNS				xxx.xxx.xxx.xxx	
	Reset					Include LAN and Control
Control	Crestron			On	Off / On (ICON)	Port 41794
	Extron			On	Off / On (ICON)	Port 2023
	PJ Link			On	Off / On (ICON)	Port 4352
	AMX Device Discovery			On	Off / On (ICON)	Port 9131
	Telnet			On	Off / On (ICON)	Port 23
	HTTP			On	Off / On (ICON)	Port 80 : Webpage control

INFO MENU

Level 1 (Sub)	Level 2 (Sub)	Level 3 (Sub)	Level 4 (Sub)	Data		Remark
				Default	Value	
Serial Number				(DisplayOnly)		
Source				(DisplayOnly)		
Resolution				(DisplayOnly)		
Refresh Rate				(DisplayOnly)		
Display Mode				(DisplayOnly)		
Power Mode (Standby)				(DisplayOnly)		
Light Source Hours				(DisplayOnly)		
Network Status				(DisplayOnly)		
IP Address				(DisplayOnly)		
Brightness Mode				(DisplayOnly)		
Firmware Version	System			(DisplayOnly)		
	LAN			(DisplayOnly)		
	MCU			(DisplayOnly)		

SPECIFICATIONS

NOTICE

All specifications are subject to change without notice.

GENERAL

Parameter	INL2156	INL2166	INL2158	INL2168	INL2159	INL2169
Dimensions (W x H x D)	337 x 265 x 119.3mm (13.26 x 10.43 x 4.7in)					
Weight	4.2Kg (9.3lb)		4.6Kg (10.1 lb)			
Fan noise	28dB A to 30dB A					
Audio	1 x 10W					
Altitude	0 to 3050m (0 to 10000ft)					
Temperature	Operating: 0 to 40° C (32 to 104° F) Storage: -10° to 60° C (14 to 140° F)					
Humidity	Operating: 0% to 85% Storage: 0% to 85%					
Security	1 x Kensington Security Slot Security PIN Security timer					

VIDEO

Parameter	INL2156	INL2166	INL2158	INL2168	INL2159	INL2169
Brightness (Lumens)	4500	5000	4000	4500	4000	4500
Native resolution	WXGA		Full HD (1080p)		WUXGA	
Pixels	1280 x 800		1920 x 1080		1920 x 1200	
Aspect ratio	16:10		16:9		16:10	
Panel size	0.65"		0.47"		0.48"	

Parameter	INL2156	INL2166	INL2158	INL2168	INL2159	INL2169
Projection technology	Texas Instruments DLP®					
Light source	Quantum Laser™					
3D support	All major formats					
Contrast ratio	300000:1					
Light source life	30000 hours					
Maximum supported resolution	4096 x 2160 (4K) @ 50Hz					
Horizontal sync. range	15KHz to 100KHz					
Vertical sync. range	23Hz to 120Hz					
Uniformity	85%					

OPTICAL

Parameter	INL2156	INL2166	INL2158	INL2168	INL2159	INL2169
Lens shift - vertical	--	--	--	105% to 115%	--	100% to 110%
Lens shift - horizontal	--					
Lens zoom	1.3x					
Lens zoom adjustment	Manual					
Keystone adjustment	Automatic/Manual					
Keystone correction	±30° Vertical and ±30° Horizontal					
Projection factor	1.19 to 1.54:1		1.21 to 1.59:1			
Projection distance [m]	1 to 7.7m (3.3 to 25.3ft)		1 to 8.1m (3.28 to 26.6ft)		1 to 7.9m (3.3 to 25.9ft)	
Optical zoom	Manual					
Digital zoom Demagnification/magnification	0.8x to 2.0x					
Focus adjustment	Manual					

CONNECTIVITY

Parameter	INL2156	INL2166	INL2158	INL2168	INL2159	INL2169
Audio input	3.5mm Stereo Mini Jack					
Audio output	3.5mm Stereo Mini Jack					
Video input (analog)	VGA (Mini D-sub 15-pin) Composite					
Video input (digital)	HDMI 2.0 (HDCP 2.2) HDMI 1.4					
Control	RS232 RJ45 Micro USB					
Service	Micro USB					
Powered USB (for wi-fi)	USB 2.0 1.5A / 2.5W					

POWER

Parameter	INL2156	INL2166	INL2158	INL2168	INL2159	INL2169
Power supply	100-240V AC; 50 to 60Hz					
Power consumption	157W to 211W					
Power consumption network standby	< 2W					
Power consumption standby	< 0.5W					

PRODUCT COMPLIANCE

FCC COMPLIANCE STATEMENT - CLASS B

This equipment generates, uses and can radiate radio frequency energy, and if not installed and used in accordance with the instruction manual may cause interference to radio communications. It has been tested and found to comply with the limits for a Class "B" computing device pursuant to Subpart B of Part 15 of the FCC Rules, which are designed to provide reasonable protection against such interference when operated in a residential installation. However, there is no guarantee that interference will not occur in a particular installation. If this product does cause harmful interference to radio or television reception, or any other form of communication, the user is encouraged to try to correct the interference by one or more of the following measures:

- Reorient or relocate the receiving antenna.
- Increase the separation between the product and receiver.
- Connect the product to an outlet on a circuit different from that to which the receiver is connected.
- Consult the dealer or an experienced radio/TV technician for help.

Any changes or modifications not expressly approved by the party responsible for compliance may void the user's authority to operate the product. Where shielded interface cables have been provided with the product, specified additional components or accessories elsewhere defined to be used with the installation of the product, they shall be used in order to ensure compliance with FCC regulations.

NOTICE

This Class B digital apparatus complies with Canadian ICES-003.

Cet appareil numérique de la classe B est conforme à la norme NMB-003 du Canada.

INDUSTRY CANADA REGULATORY INFORMATION

Operation is subject to the following two conditions:

- (1) this device may not cause interference, and
- (2) this device must accept any interference, including interference that may cause undesired operation of the device.

The user is cautioned that this device should be used only as specified within this manual to meet RF exposure requirements. Use of this device in a manner inconsistent with this manual could lead to excessive RF exposure conditions.

INSTRUCTIONS TO USERS: This equipment complies with the requirements of FCC equipment provided that the following conditions are met. If the cables include a EMI ferrite core, attach the ferrite core end of the cable to the projector. Use the cables which are included with the projector or specified.

NOTICE

Changes or modifications not expressly approved by the party responsible for compliance could void the user's authority to operate the equipment.

Complies with IDA Standards DA103121

CE STATEMENT

Electromagnetic Compatibility Statement: Meets 2014/30/EU Directive

Low Voltage Directive: Meets 2014/35/EU Directive

WARRANTY

INFOCUS LIMITED WARRANTY

For product purchases effective 1st January 2021

WARRANTY STATEMENT

InFocus warrants its products to be free from defects in material and workmanship during the warranty period. If a product proves to be defective in material or workmanship during the warranty period, InFocus will, at its sole option, repair or replace the product with a similar product. Replacement Products or parts may include remanufactured or refurbished parts or components. The replacement unit will be covered by the balance of time remaining on the customer's original limited warranty. InFocus provides no warranty for any third-party software whether included with the product or installed by the customer, installation of any unauthorized or third party hardware parts or components (e.g. Projector Lamps).

DEAD ON ARRIVAL (DOA)

All brand new InFocus products carry a thirty (30) day Dead on Arrival (DOA) warranty policy for the first consumer purchaser. A new replacement unit will be provided if the Product is found to be non-operational within thirty (30) days of purchase and freight shall be covered both ways by InFocus.

WHO THE WARRANTY PROTECTS

This warranty is valid only for the first consumer purchaser, it is nontransferable.

WARRANTY PERIOD

Product	Period
Laser Illumination Projectors	5 years or 20,000 hours which ever comes first
Lamp Illumination and LED Illumination Projectors	2 years
Interactive Touch Displays	3 years
OPS and Slotable PC's	1 year
Original Lamp Contained Within Projector	1 year or 1,000 hours which ever comes first
Replacement lamps and Other Accessories	3 months

WHAT THE WARRANTY DOES NOT COVER

1. Any product on which the serial number has been defaced, modified or removed.
2. Damage, deterioration or malfunction resulting from:
 - a. Accident, misuse, neglect, fire, water, lightning, or other acts of nature, unauthorized product modification, or failure to follow instructions supplied with the product.
 - b. Repair or attempted repair by anyone not authorized by InFocus.
 - c. Damage to or loss of any programs, data or removable storage media.
 - d. Software or data loss occurring during repair or replacement.
 - e. Any damage of the product due to shipment.
 - f. Removal or installation of the product.
 - g. Causes external to the product, such as electric power fluctuations or failure.
 - h. Use of supplies or parts not meeting InFocus specifications.
 - i. Normal wear and tear.
 - j. Failure of owner to perform periodic product maintenance as stated in User Guide.
 - k. Any other cause which does not relate to a product defect.
 - l. Damage caused by static (non-moving) images displayed for lengthy periods of time (image burn-in)
 - m. Any third-party software included with the product or installed by the customer.
 - n. Installation of any unauthorized hardware, accessories, consumable parts or components
 - o. Damage to, or abuse of, the coating on the surface of the display through inappropriate cleaning as described in product User Guide.

OBTAINING WARRANTY SERVICE

Submit your request to us online: <https://infocus.com/support/technical-support> or call your local InFocus support hotline which can be found at: <https://infocus.com/support/contact-us>. Be sure to read our RMA instruction closely to ensure a smooth and timely process of your report, these will be sent to you with the RMA confirmation.

NOTICE

Products presented for delivery at InFocus repair or logistics centre without an assigned RMA will be refused and returned to sender. Products delivered to InFocus repair or logistics centre damaged will be held and customer will be notified. It is the responsibility of sender to file claims directly with their freight carrier company.

LIMITATION OF IMPLIED WARRANTIES

To the extent allowed by local law, this product is provided to you "as is" without warranties or conditions of any kind, whether oral or written, express or implied. InFocus specifically disclaims any implied warranties or conditions of merchantability, satisfactory quality, noninfringement and fitness for a particular purpose.

EXCLUSION OF DAMAGES

InFocus's liability is limited to the cost of repair or replacement of the product. InFocus shall not be liable for;

- 1) Damage to other property caused by any defects in the product. .
- 2) Damages based upon inconvenience, lost profit, lost data or downtime costs, loss of use of the product, loss of time, loss of profits, loss of business opportunity, loss of goodwill, interference with business relationships, or other commercial loss, even if advised of the possibility of such damages.
- 3) Any other damages, whether direct, special, incidental, consequential or otherwise.
- 4) Any claim against the customer by any other party.

LOCAL LAW

This warranty gives you specific legal rights, and you may also have other rights which vary from locality to locality. Some localities do not allow limitations on implied warranties and/or do not allow the exclusion of incidental or consequential damages, so the above limitations and exclusions may not apply to you.

TRADEMARKS

InFocus and the InFocus wordmark are registered trademarks of InFocus Corporation. used under license. InFocus branded projectors and interactive touch displays are brought to the market by Maxnerva Technology Services Limited a Foxconn affiliated company and its subsidiaries Maxnerva Technology Services US LLC, Maxnerva (Shenzhen) Technology Services Co., Limited and Grand Field Technology Limited.

All other trademarks or registered trademarks are property of their respective companies.

Copyright © 2021 by Maxnerva Technology Services Limited.

All rights reserved. No part of this publication may be reproduced, distributed, or transmitted in any form or by any means, including photocopying, recording, or other electronic or mechanical methods, without the prior written permission.

COMPANY AND REGULATORY ADMINISTRATION

Manufacturer, EU importer and EU Authorised Representative in accordance with EU directives

Manufacturer

Maxnerva Technology Services Limited

Room 1001, 10/F, Houston Centre, 63 Mody Road, Tsim Sha Tsui East, Kowloon, Hong Kong.

EU Importer

Grand Field Technology Limited

Room 1001, 10/F, Houston Centre, 63 Mody Road, Tsim Sha Tsui East, Kowloon, Hong Kong.

EU Authorised Representative

24Hour-AR

Storgatan 51, 903 26 Umeå, Sweden

☎ +46 (0)10-424 00 20

✉ info@24hour-ar.com

🌐 www.24hour-ar.com

UK Authorised Representative in accordance with UK regulations

Independent Quality Solutions Ltd

Enterprise House, Wrest Park, Silsoe, Bedfordshire, MK45 4HR

☎ +44 (0)1462 713322

✉ enquiries@i-q-s.co.uk

🌐 www.i-q-s.co.uk

Russian Authorised Representative

InFocus has appointed AUVIX LLC, 129085, c. Moscow, Zvezdny Boulevard, 21, bldg. 1. as the authorised representative in Russia and this product is compliant with TR TC 004/2011, TR TC 020/2011 and TR CU 020/2011 local conformity testing and approvals.

«InFocus назначил ООО « АУВИКС », 129085, г. Москва, Звездный бульвар, д. 21, стр. 1., в качестве официального представителя в России, и этот продукт соответствует требованиям TR TC 004/2011, TR TC 020/2011 и TR CU 020 / 2011г. местные испытания на соответствие и согласования»

ООО « АУВИКС »

129085, г. Москва, Звездный бульвар, д. 21, стр. 1

☎ +7 (495) 797-57-75

✉ info@auvix.ru

US Importer and Local Representative in accordance with FCC regulations

Maxnerva Technology Services USA LLC

13190 SW 68th Parkway, Suite 120

Portland, Oregon 97223, USA