



Booklet available in English on  
Livret disponible en français sur  
Folleto disponible en español en



WELCOME TO SINGAPORE  
BIENVENUE À SINGAPOUR  
TE DAMOS LA BIENVENIDA A SINGAPUR



Lying at the southern tip of the Malay Peninsula, the city-state of Singapore is the gateway between East and West. This is especially evident in the city's architecture, which is a melting pot of many styles and influences set against a backdrop of lush greenery and a vibrant riverfront.

Située à l'extrémité sud de la péninsule malaise, la cité-État de Singapour est la charnière entre l'Orient et l'Occident. L'architecture de la ville, un amalgame de nombreux styles et influences avec pour toile de fond une végétation luxuriante et une rive animée, en fait montre.

Ubicada en el extremo sur de la península de Malaca, la ciudad-Estado de Singapur es la puerta de enlace entre Oriente y Occidente. Así lo demuestra con rotundidad su arquitectura, un crisol de estilos e influencias diversas con un telón de fondo tan magnífico como su exuberante vegetación y las riberas de su río, rebosantes de actividad.



**ROK ZGALIN KOBE**

*Senior Designer at the LEGO Group  
Concepteur principal chez le Groupe LEGO  
Diseñador sénior de The LEGO Group*

## FROM THE DESIGN TEAM UN MOT DE L'ÉQUIPE DE CONCEPTION IMPRESIONES DEL EQUIPO DE DISEÑO

With a passion for architecture, LEGO® building and Singapore, Rok Zgalin Kobe was the perfect LEGO designer for this set. For him, the biggest challenge wasn't so much selecting the right mix of old and new structures for the model but attempting to capture the unique atmosphere of the vibrant city in LEGO elements.

Passionné d'architecture, de construction LEGO® et de Singapour, Rok Zgalin Kobe était le concepteur LEGO tout désigné pour cet ensemble. Pour lui, le plus grand défi n'a pas été de sélectionner pour le modèle le parfait mélange de structures anciennes et nouvelles, mais bien de tenter de saisir l'atmosphère unique de cette ville dynamique avec des éléments LEGO.

Verdadero apasionado de la arquitectura, la construcción con LEGO® y Singapur, Rok Zgalin Kobe era el diseñador de LEGO ideal para este set. Para él, el mayor desafío no radicaba tanto en seleccionar la combinación adecuada de estructuras antiguas y modernas, sino más bien en tratar de capturar la irreplicable atmósfera de esta animada ciudad con elementos LEGO.

## MARINA BAY SANDS LE MARINA BAY SANDS



Opened in 2010, the impressive Marina Bay Sands is an integrated resort made up of three individual towers connected at the top by the 1,120 ft. long (340 meter long) Sands SkyPark. This is the world's largest public cantilevered platform and includes gardens, restaurants and a dramatic 490 ft. (150 m) infinity swimming pool.

L'impressionnant Marina Bay Sands, qui a ouvert ses portes en 2010, est un complexe touristique composé de trois tours individuelles reliées au sommet par la terrasse Sands SkyPark, mesurant 340 m (1120 pi) de longueur. Il s'agit de la plus grande plate-forme en porte-à-faux publique au monde. Elle comprend des jardins, des restaurants et une spectaculaire piscine à débordement de 150 m (490 pi) de longueur.

Inaugurado en 2010, el impresionante complejo Marina Bay Sands está formado por tres torres independientes conectadas por una única plataforma de 340 m de longitud que las corona y que alberga un parque al aire libre: el Sands SkyPark. Es la plataforma pública en voladizo más grande del mundo e incluye jardines, restaurantes y una espectacular alberca infinita con un borde de 150 m.



## OCBC CENTRE L'OCBC CENTRE

Designed to be seen both as a symbol of strength and permanence, the OCBC Centre consists of two semi-circular reinforced concrete cores and three lateral girders in the Brutalist architectural style. The 649 ft. (198 m) tall structure was the tallest building in Singapore when it was completed in 1976.

Conçu pour être un symbole de force et de permanence dans le style architectural brutaliste, l'OCBC Centre est composé de deux noyaux semi-circulaires en béton armé et de trois poutres latérales. Le gratte-ciel de 198 m (649 pi) de hauteur était le plus haut immeuble de Singapour à son achèvement en 1976.

Concebido como símbolo de solidez y permanencia, el OCBC Centre se compone, estructuralmente, de dos núcleos semicirculares de concreto reforzado unidos por tres vigas laterales y es una muestra del estilo arquitectónico brutalista. La imponente construcción de 198 m de altura se convirtió en el edificio más alto de Singapur al terminarse en 1976.

## ONE RAFFLES PLACE LE ONE RAFFLES PLACE



Set in the heart of the financial district, One Raffles Place is one of the tallest skyscrapers in the city with a height of 920 ft. (280 m). The original tower, designed by prize-winning Japanese architect Kenzo Tange, was completed in 1986. The tower is made from two triangular structures, clad with chemically treated aluminum alloy which changes color along with the light it reflects.

Situé au cœur du quartier financier, le One Raffles Place est l'un des plus hauts gratte-ciel de la ville, avec une hauteur de 280 m (920 pi). La tour d'origine, conçue par l'architecte japonais primé Kenzo Tange, a été achevée en 1986. La tour est composée de deux structures triangulaires, revêtues d'un alliage d'aluminium traité chimiquement qui change de couleur en fonction de la lumière qu'il reflète.

Ubicado en el corazón del distrito financiero, el rascacielos One Raffles Place es uno de los más altos de la ciudad y se eleva 280 m sobre el suelo. La torre original, diseñada por el premiado arquitecto japonés Kenzo Tange, se terminó de construir en 1986. Consta de dos estructuras triangulares, revestidas de una aleación de aluminio tratada químicamente que cambia de color según la luz que refleja.



## BOAT QUAY LE BOAT QUAY

Boat Quay is the historical quay situated upstream from the mouth of the Singapore River. The characteristic two- and three-story shophouses with their projecting upper floors were restored in the 1990s and are now the bustling home to many shops, restaurants and bars.

Le Boat Quay est le quai historique situé en amont de l'embouchure de la rivière Singapour. Ses maisons typiques à deux ou trois étages, dont les étages supérieurs sont saillants, ont été restaurées dans les années 1990 et abritent aujourd'hui de nombreux magasins, restaurants et bars.

Boat Quay es un muelle histórico que se encuentra aguas arriba de la desembocadura del río Singapur. Sus característicos edificios de dos y tres niveles para uso comercial y residencial, con el piso inferior retraído con respecto de los superiores, se restauraron en la década de 1990. Ahora albergan numerosas tiendas, restaurantes y bares.



## THE FULLERTON HOTEL L'HÔTEL THE FULLERTON HOTEL FULLERTON

When it was completed in 1928, the Fullerton Building dominated the city skyline and was home to the Post Office and other government offices. After a major S\$400 million (301.69 million USD) restoration, this masterpiece of neoclassical architecture officially opened as a five-star hotel on January 1<sup>st</sup>, 2001.

Lorsqu'il a été achevé en 1928, le bâtiment Fullerton dominait la silhouette de la ville et abritait le bureau de poste ainsi que d'autres bureaux gouvernementaux. Après une importante restauration au coût de 400 millions de dollars de Singapour (368 millions de dollars canadiens), ce chef-d'œuvre de l'architecture néoclassique a officiellement ouvert ses portes en tant qu'hôtel cinq étoiles le 1<sup>er</sup> janvier 2001.

Cuando se terminó en 1928, el entonces Fullerton Building dominaba el horizonte de la ciudad y era sede de la oficina de correos y otras oficinas del Gobierno. Luego de una importante restauración en la que se invirtieron 400 MSGD (301,69 MUSD), esta obra maestra de la arquitectura neoclásica reabrió sus puertas oficialmente el 1 de enero de 2001, esta vez como hotel de cinco estrellas.

## LAU PA SAT LE LAU PA SAT



Lau Pa Sat, also known as Telok Ayer Market, is a historic structure located in downtown Singapore. The Victorian, octagonal-shaped building was completed in 1894 using prefabricated cast-iron parts shipped to Singapore from a foundry in Glasgow, Scotland. Today it's a popular food court with stalls selling a variety of local cuisine.

Le Lau Pa Sat, aussi connu sous le nom de marché de Telok Ayer, est une structure historique située dans le centre-ville de Singapour. achevé en 1894, le bâtiment victorien de forme octogonale a été construit avec des pièces en fonte préfabriquées expédiées à Singapour depuis une fonderie de Glasgow, en Écosse. Aujourd'hui, c'est une aire de restauration populaire avec des kiosques vendant une variété de mets locaux.

Lau Pa Sat, conocido también como Telok Ayer Market, es un edificio histórico ubicado en el centro de Singapur. De inspiración victoriana y con forma octogonal, en su construcción, finalizada en 1894, se emplearon piezas de hierro fundido prefabricadas que llegaron a Singapur por barco desde una fundición de Glasgow (Escocia). Hoy en día es una popular plaza de comidas, con puestos en los que se pueden degustar diversos platos de la gastronomía local.

## GARDENS BY THE BAY LES JARDINS DE LA BAIE JARDINES DE LA BAHÍA



The 18 towering Supertrees measure between 82 ft. (25 m) and 164 ft. (50 m) in height and afford splendid views of the gardens and the surrounding Marina Bay area. While large canopies provide shade during the day, in the evening this vertical garden comes alive in an amazing display of light and sound.

Les 18 imposants super arbres mesurent entre 25 m (82 pi) et 50 m (164 pi) de hauteur et offrent une vue splendide sur les jardins et sur les environs de Marina Bay. La vaste canopée des arbres fournit de l'ombre pendant la journée. Le soir, ce jardin vertical prend vie dans un étonnant spectacle de lumière et de son.

Los 18 *superárboles*, con una altura de 25–50 m, ofrecen extraordinarias vistas de los jardines y del área circundante, Marina Bay. Sus amplias copas proporcionan sombra durante el día y, por la tarde, este jardín vertical cobra vida con una impresionante exhibición de luz y sonido.

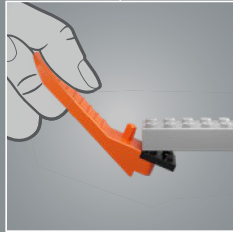
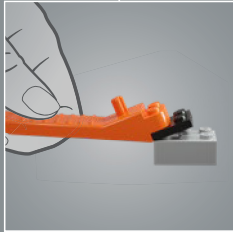
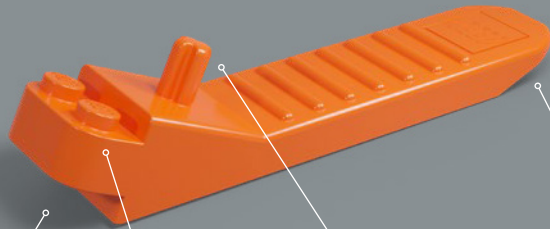



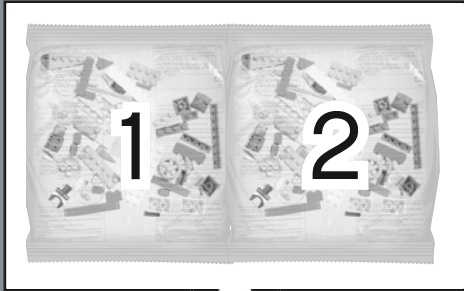

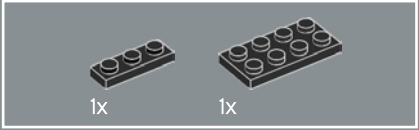
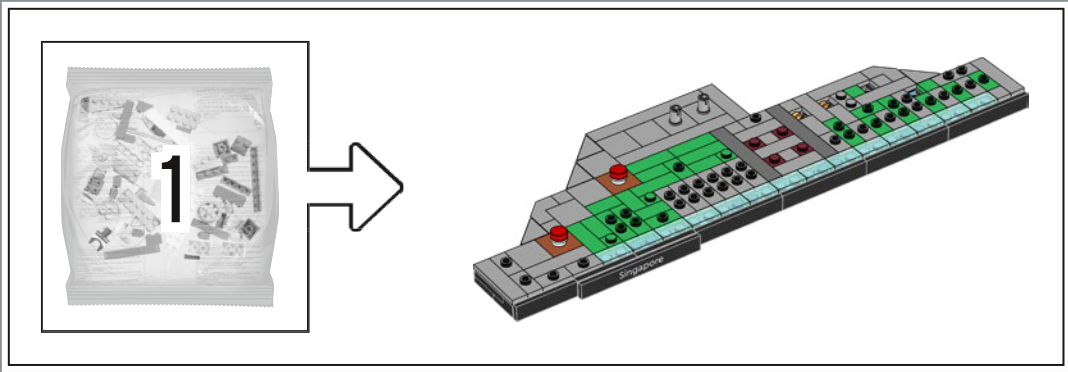

1

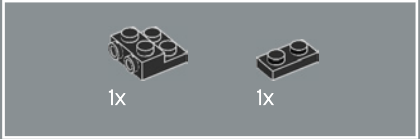
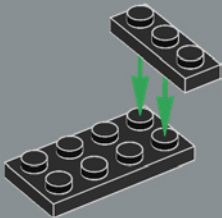

2

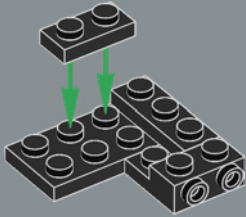

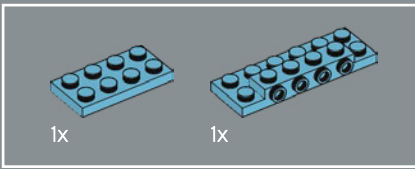

3

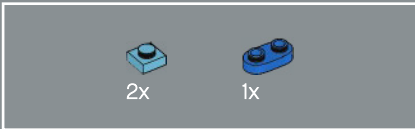
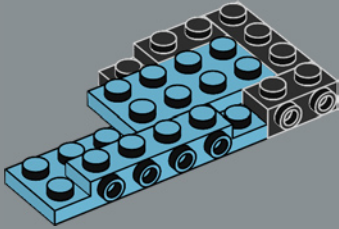

4

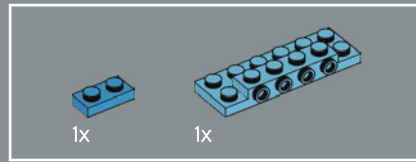
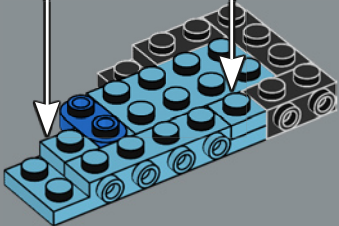

5

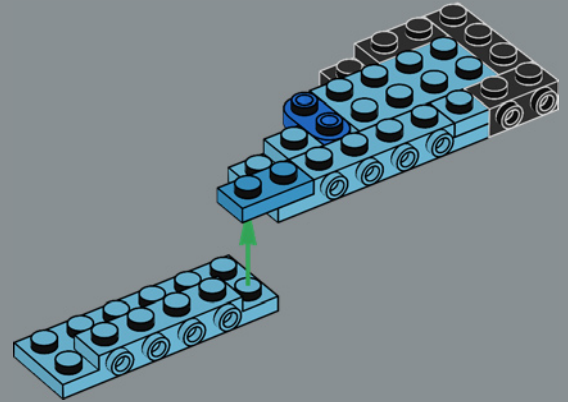

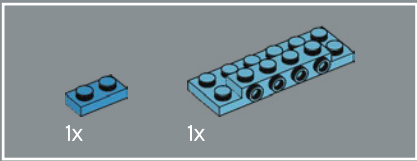

6

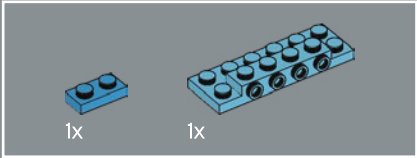
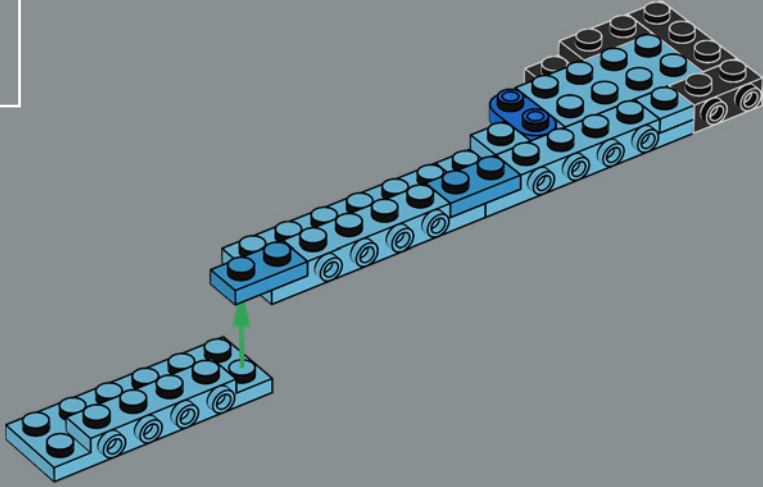

7

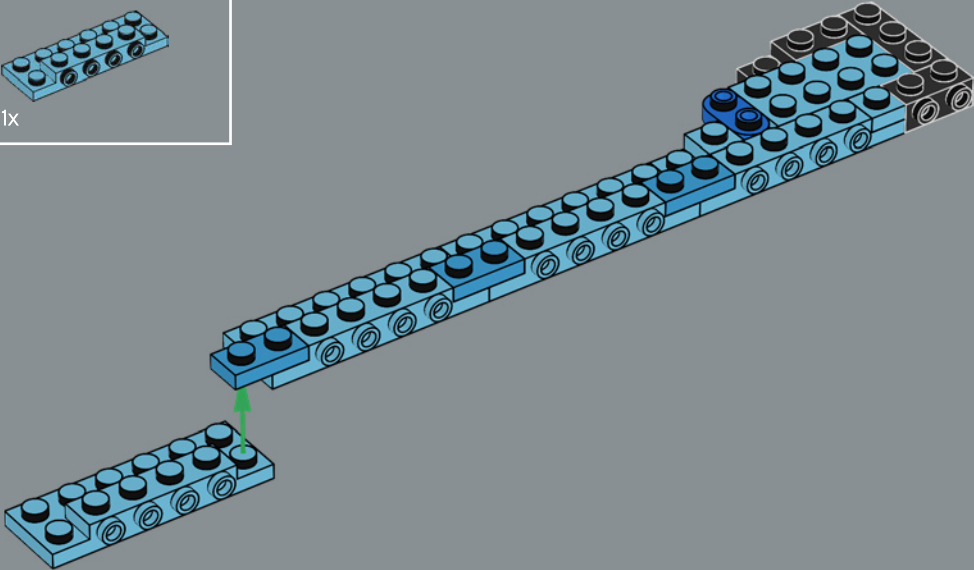

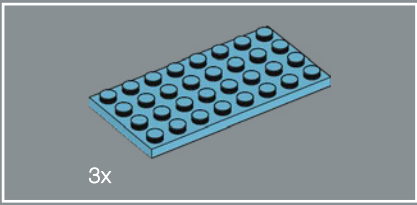

8

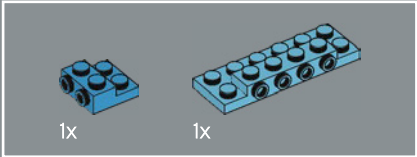
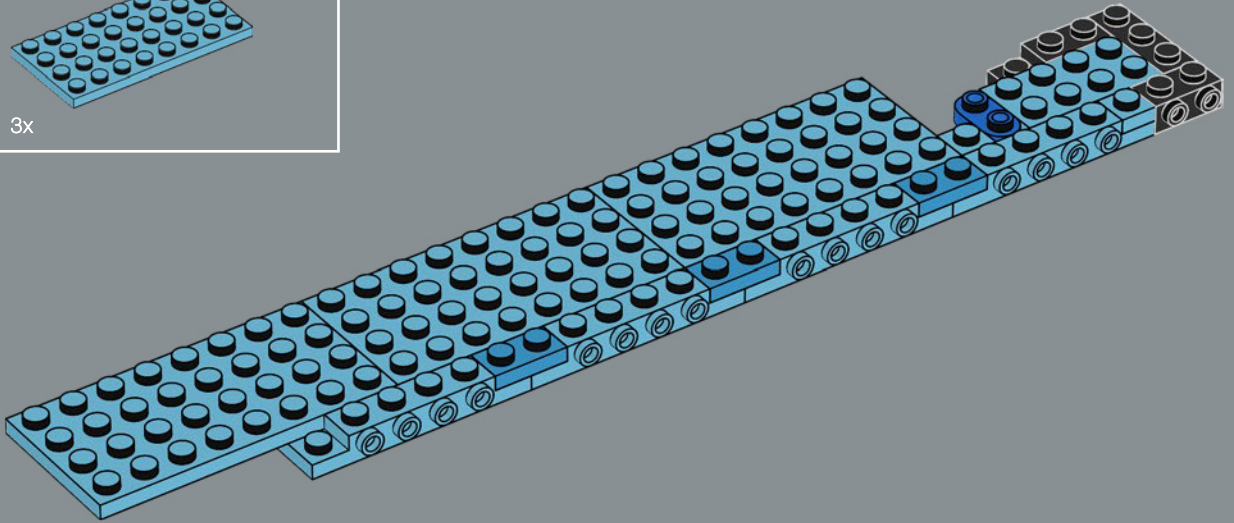

9

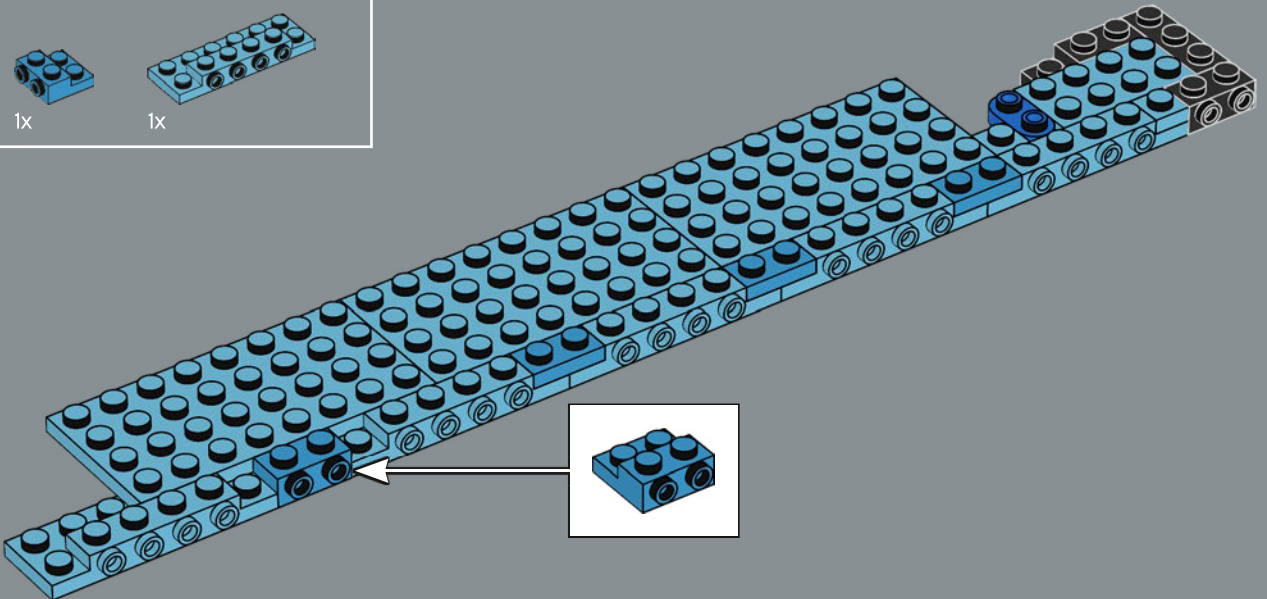

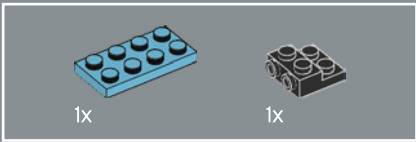

10

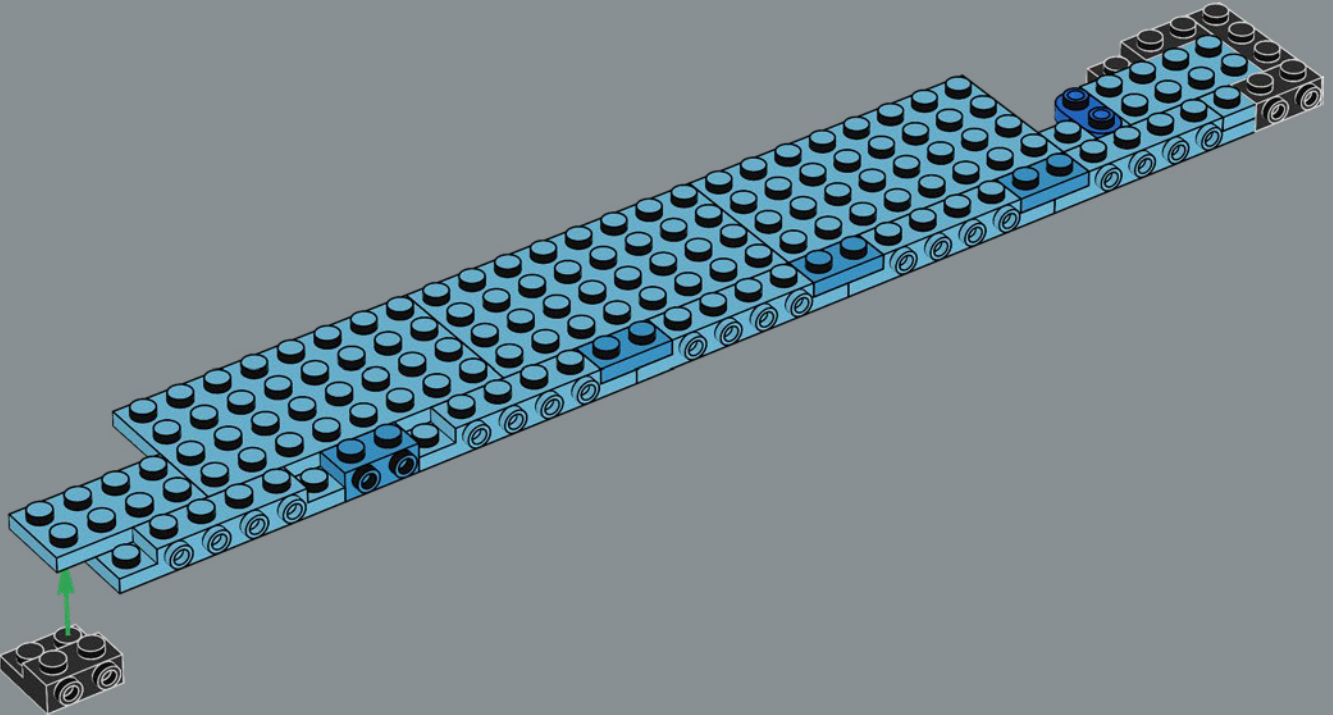

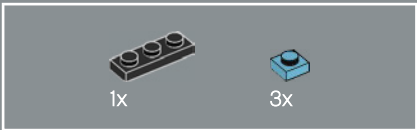

11

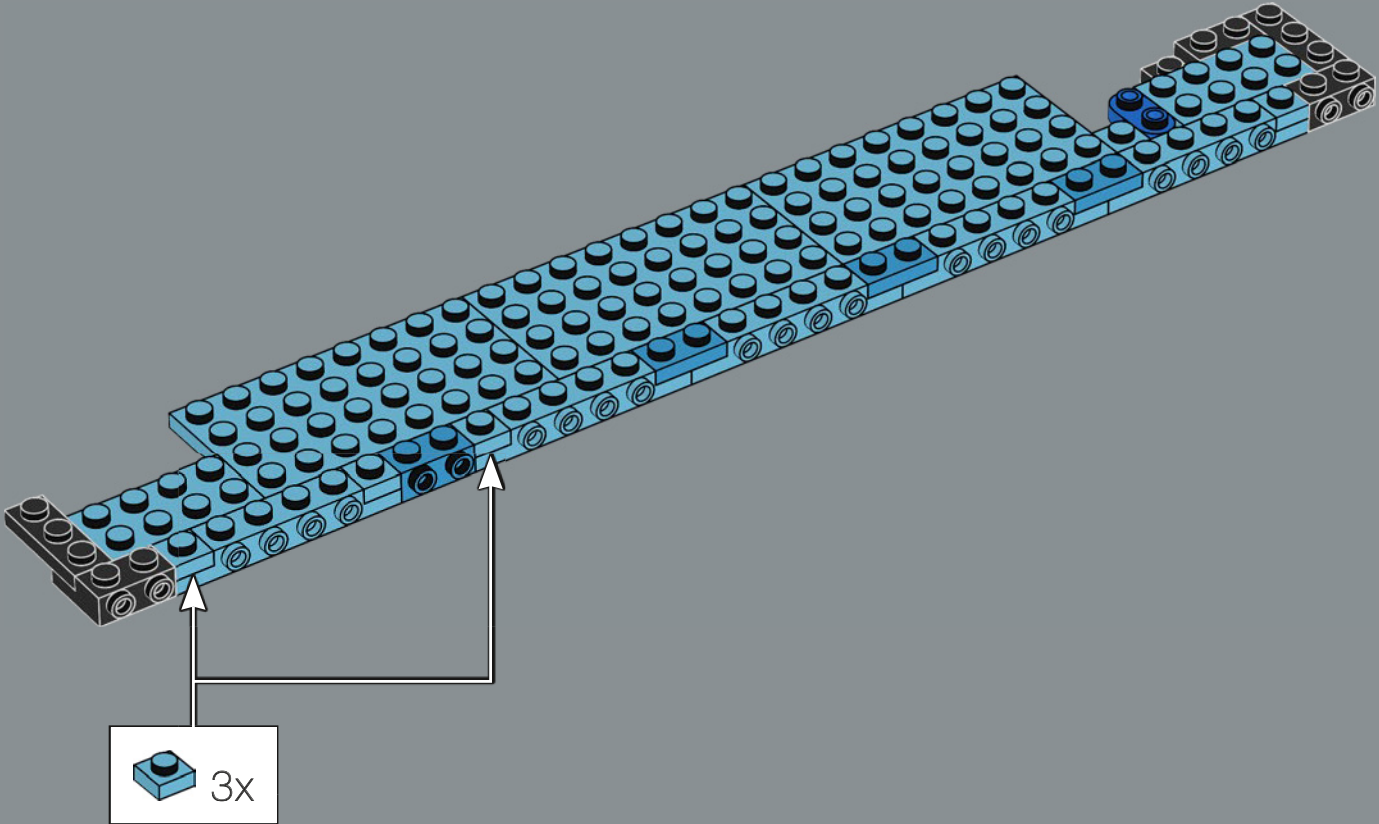

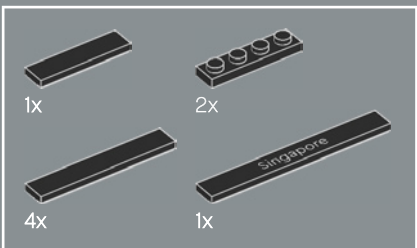

12

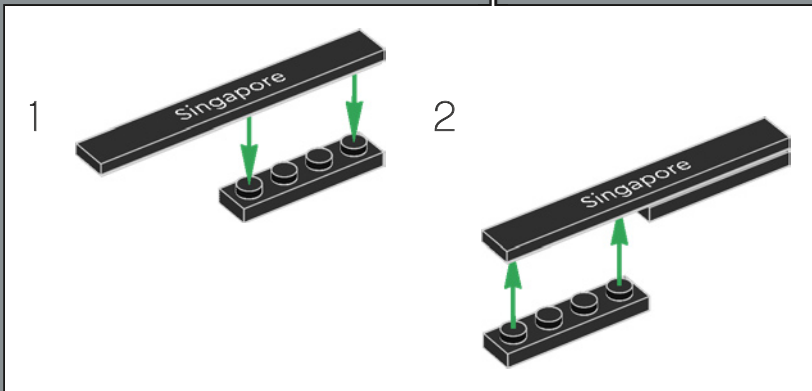
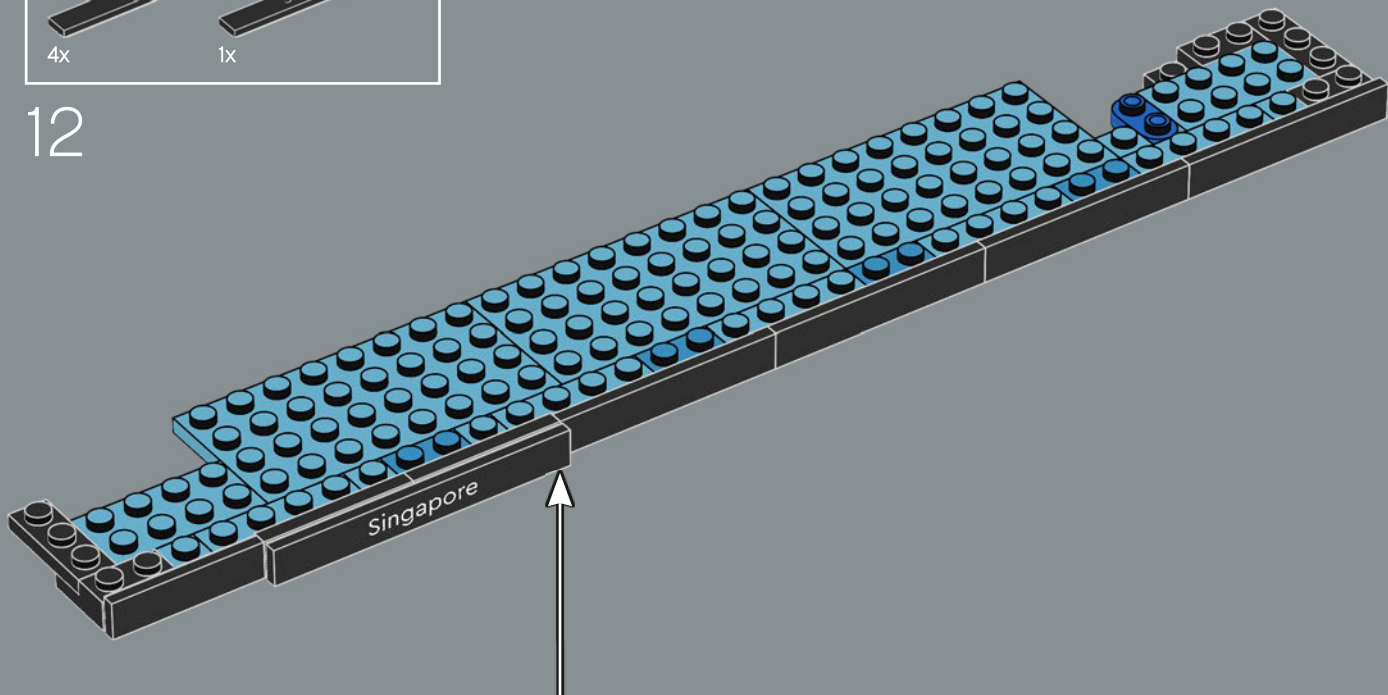



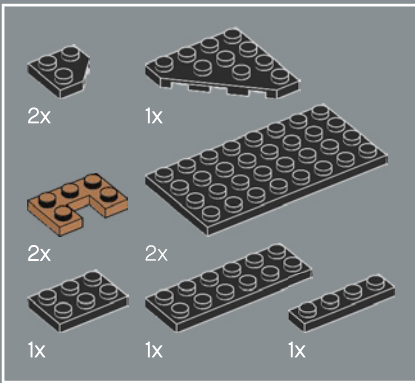

13

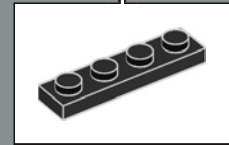
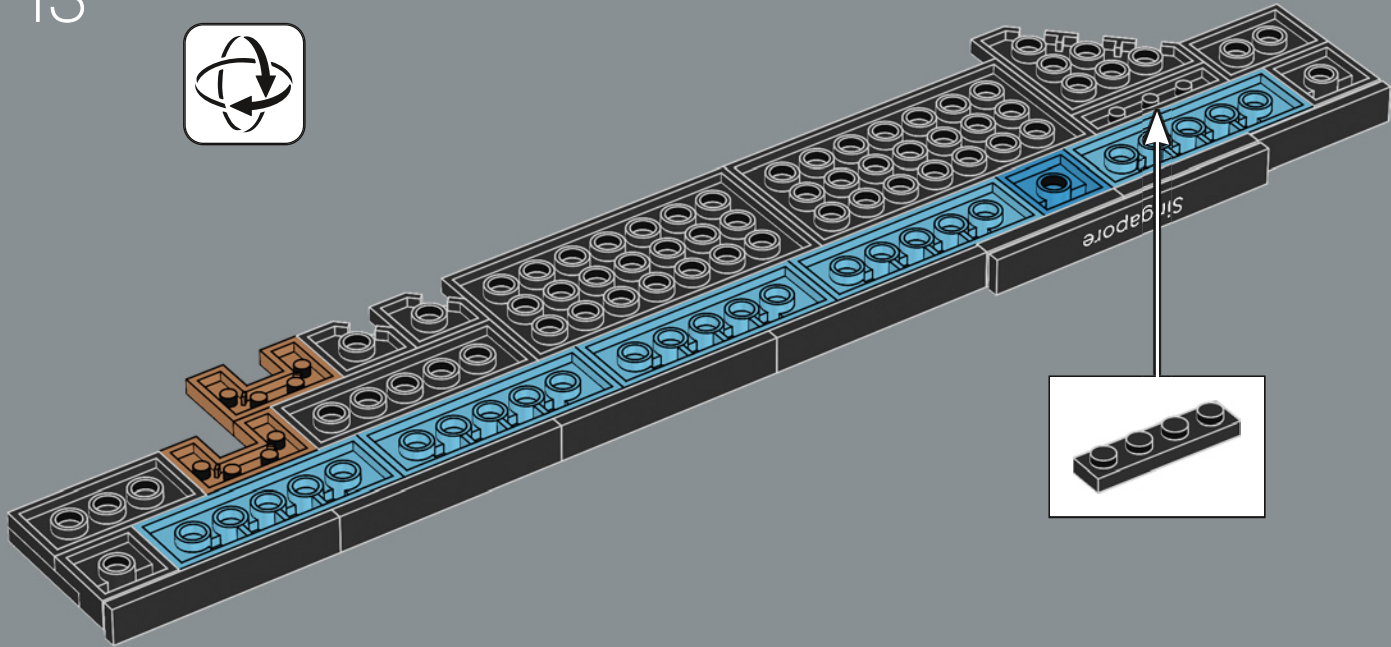

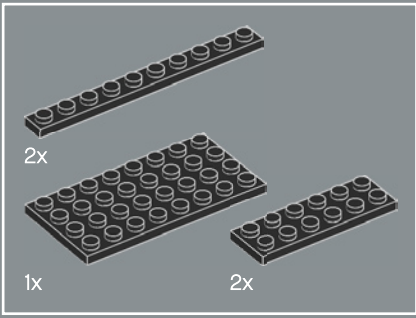

14

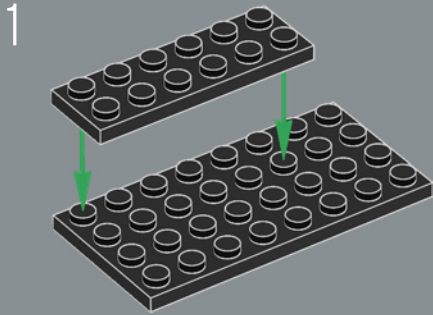

2

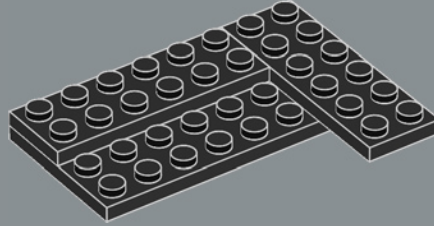

3

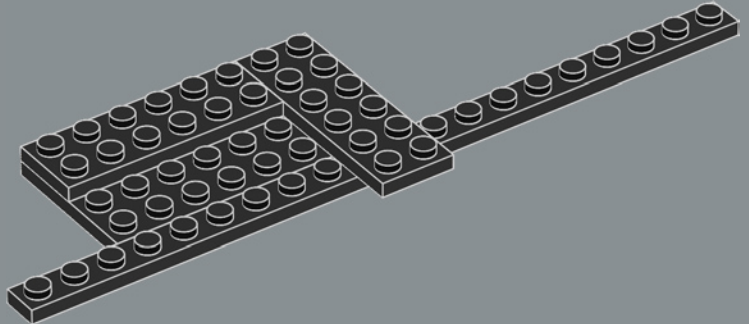

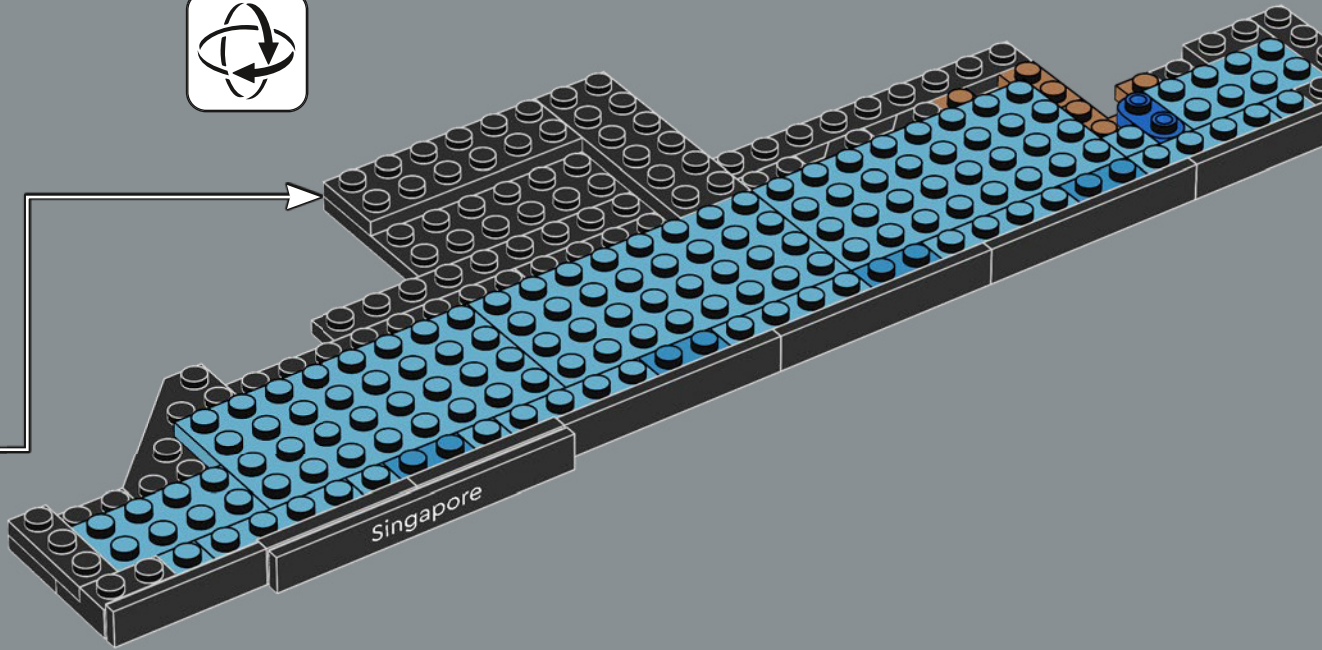

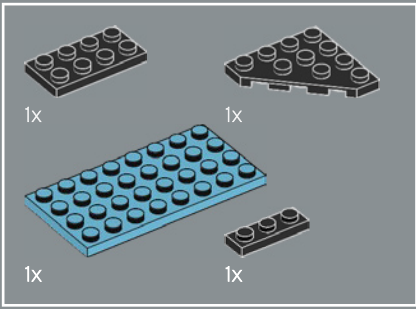

15

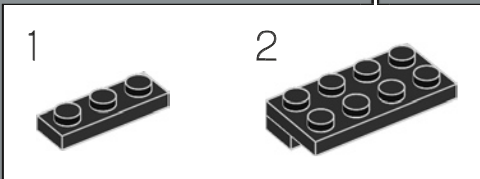
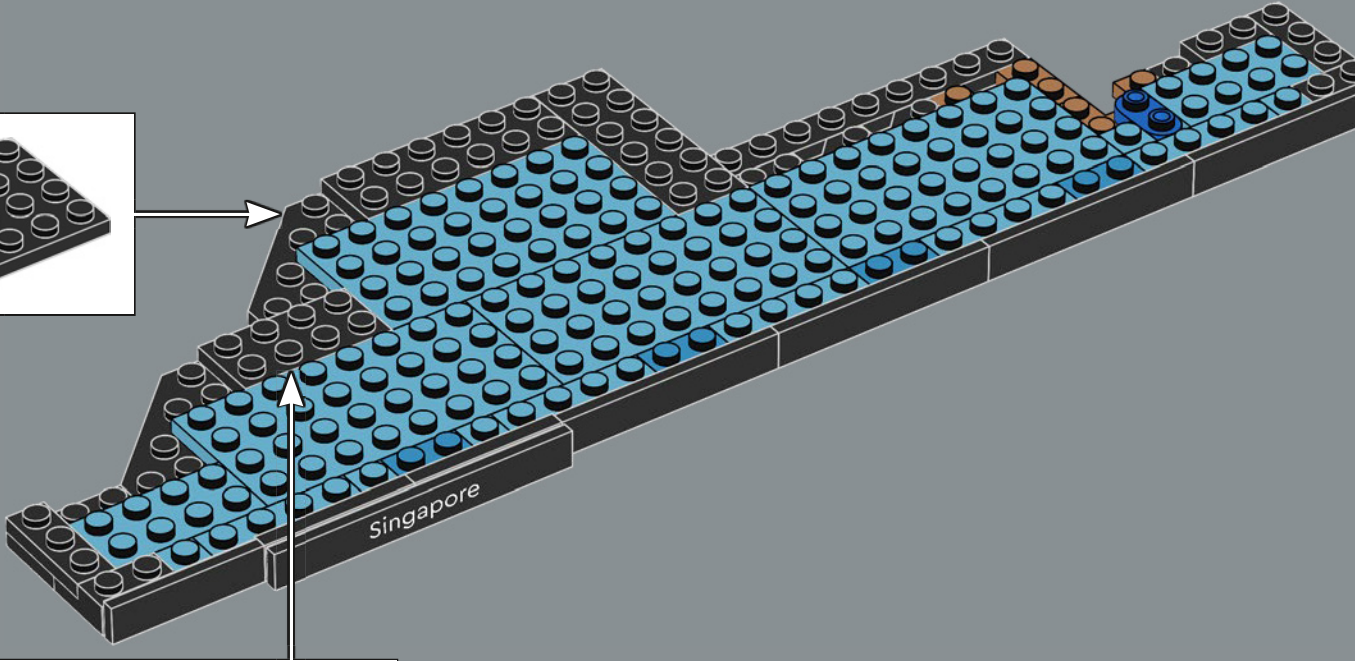
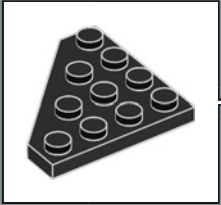

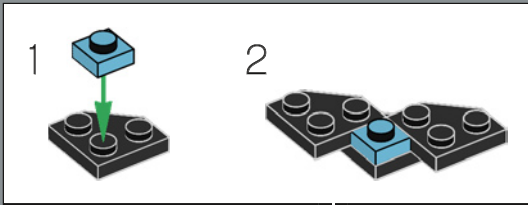
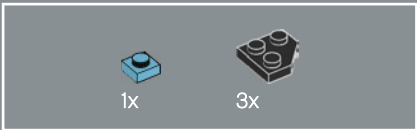

16

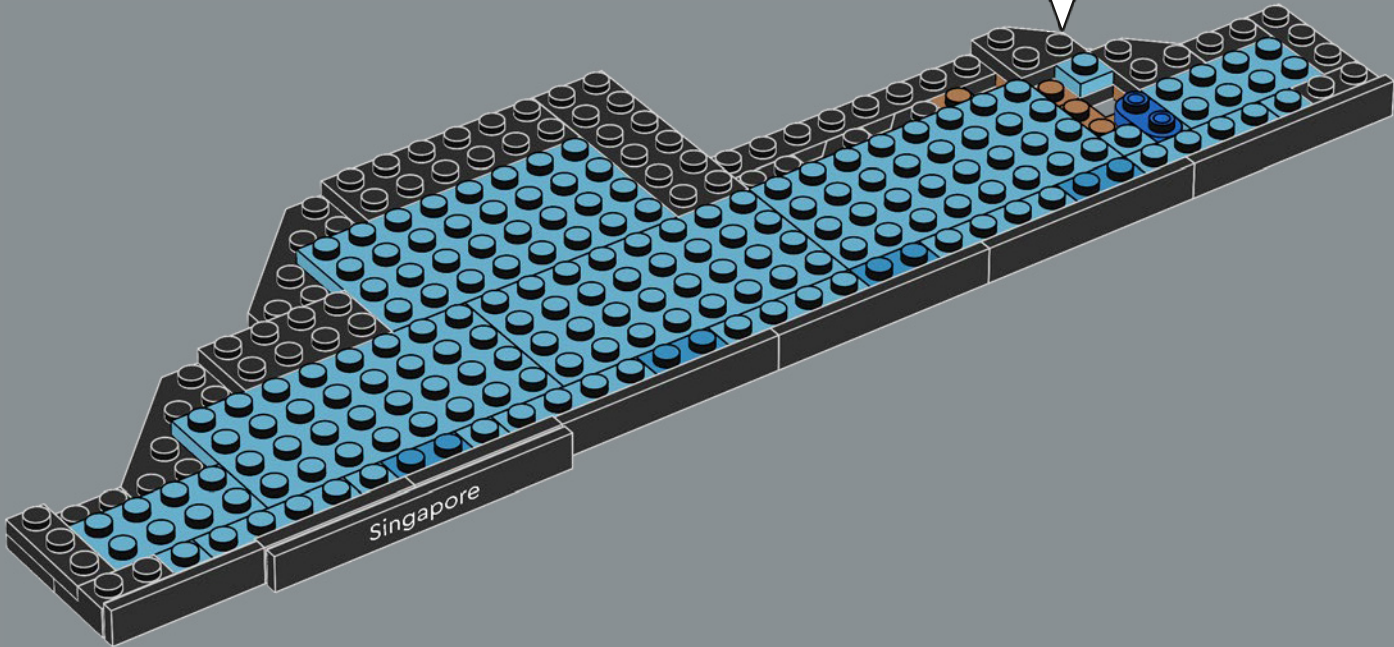

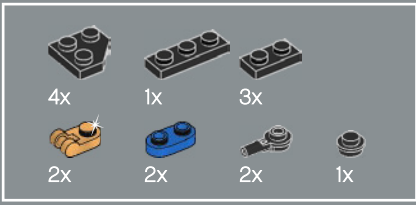

17

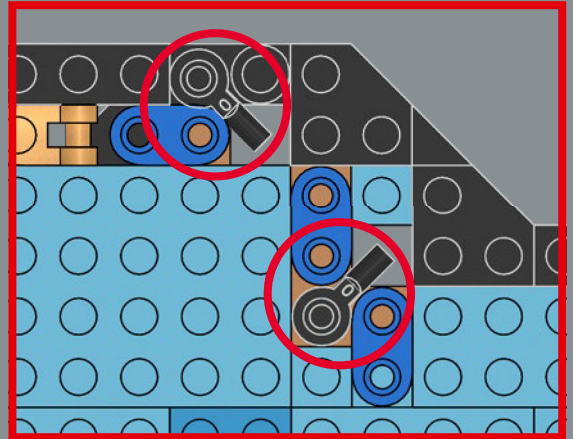
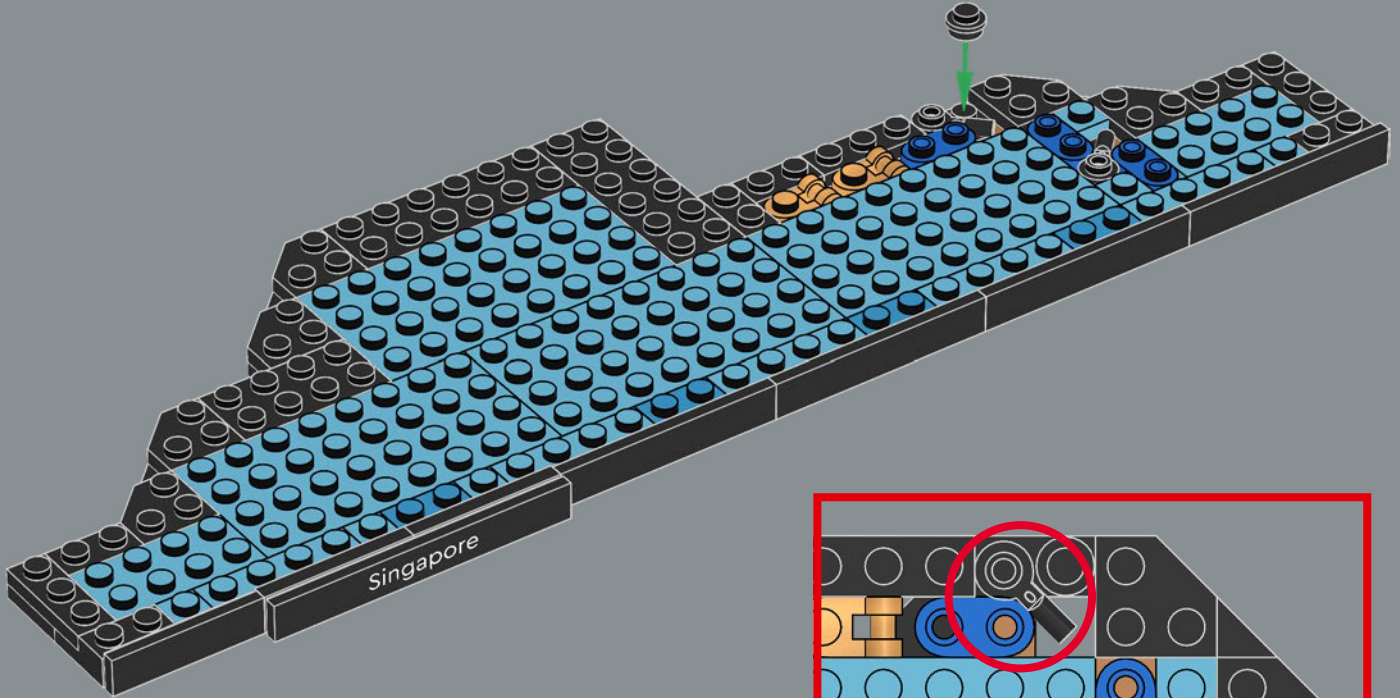

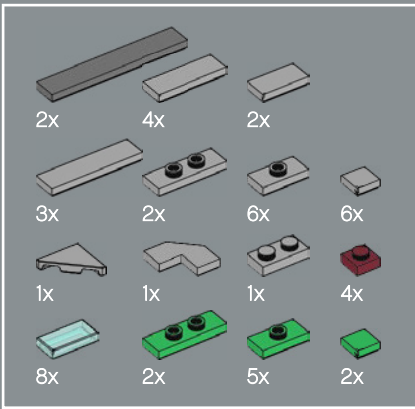

18

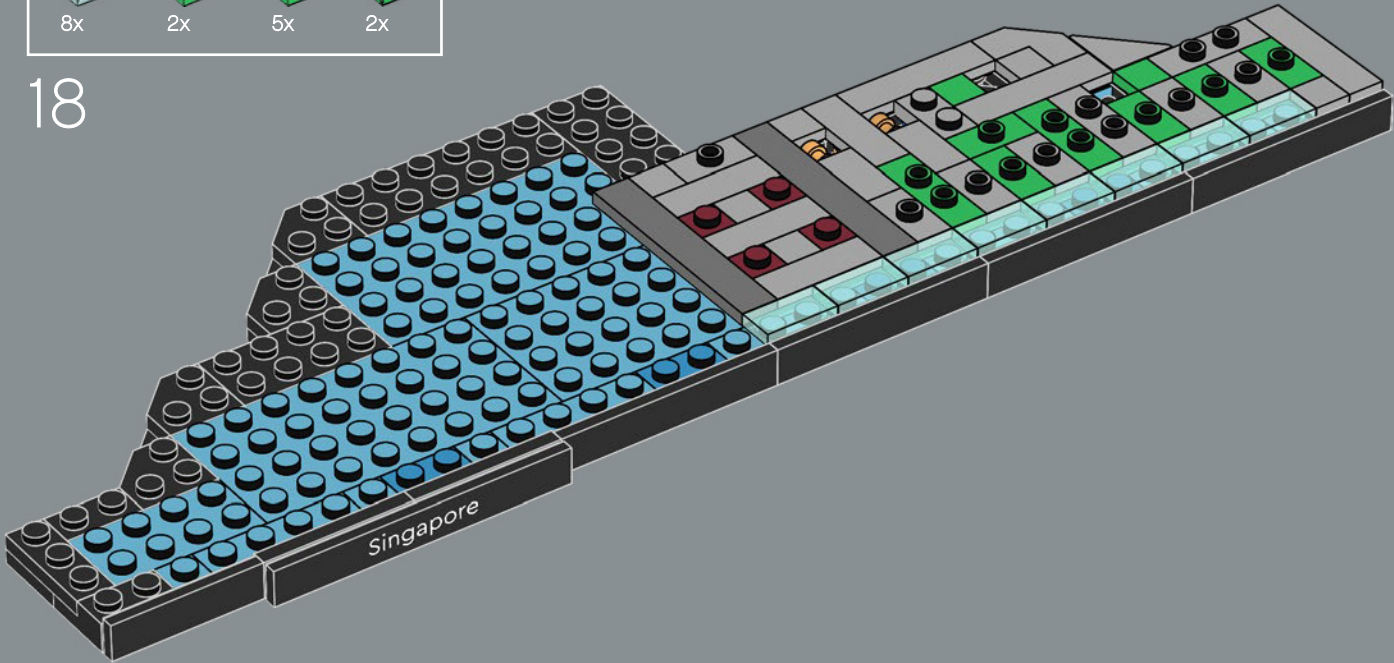

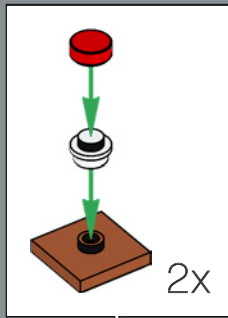
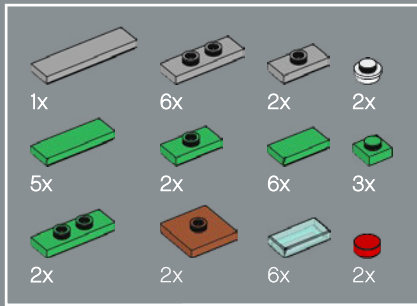

19

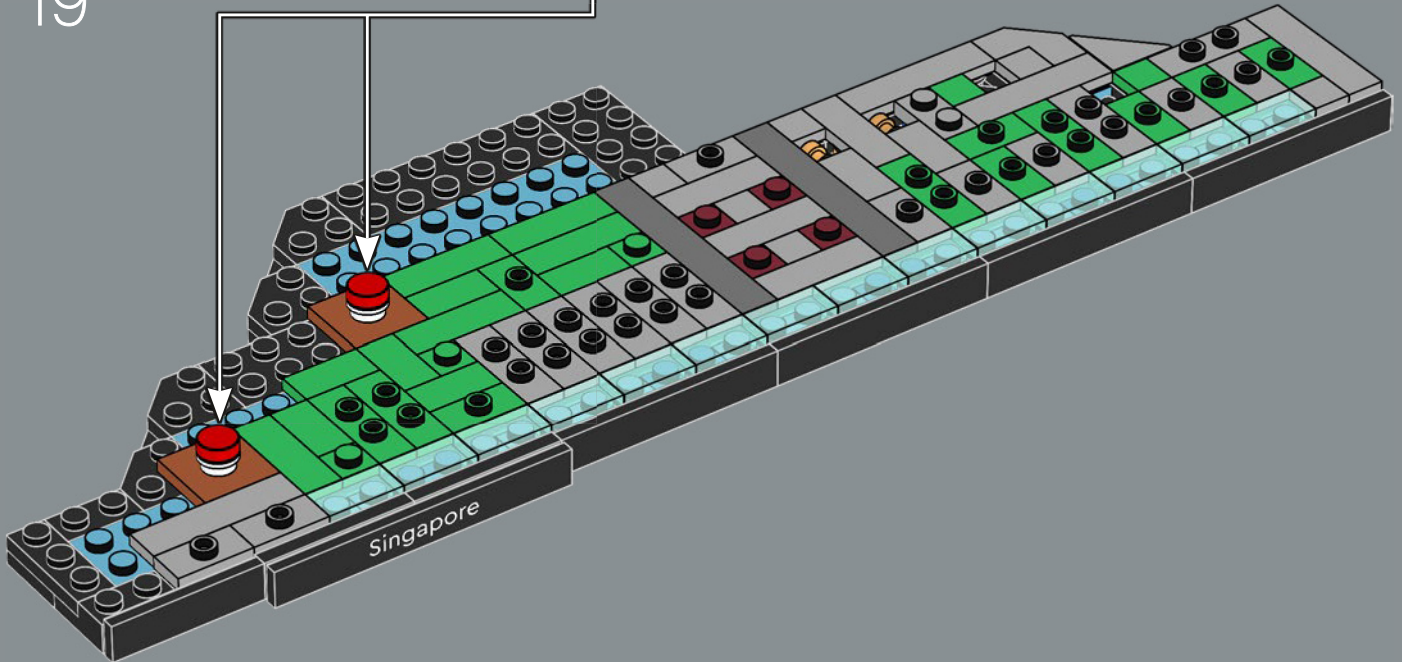

The Singapore River stretches almost the full width of the model.

La rivière Singapour s'étend sur presque toute la largeur du modèle.

El río Singapur se extiende prácticamente por toda la anchura del modelo.

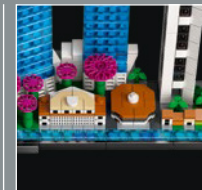



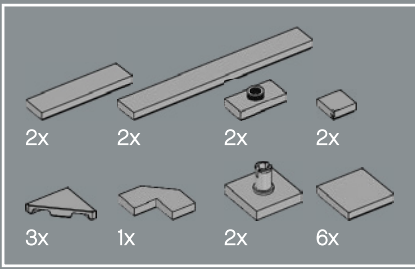

20

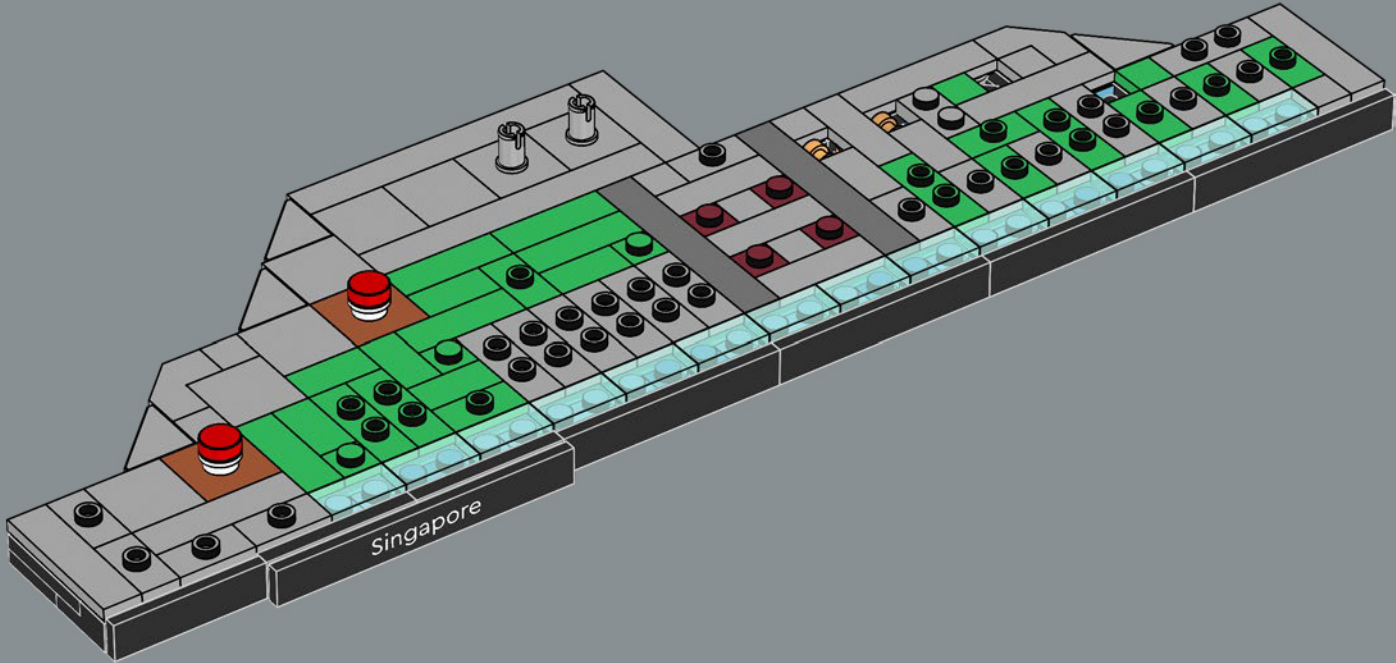

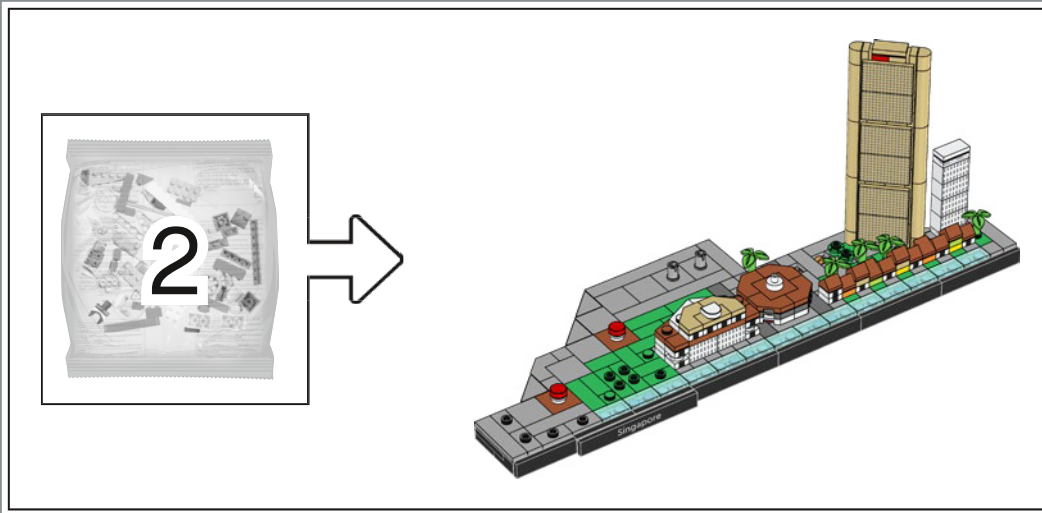

21

1

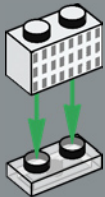

2

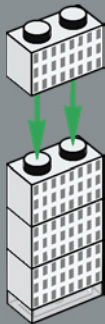

3

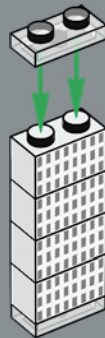

4

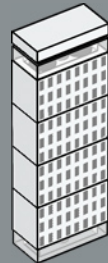

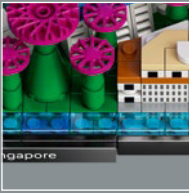

The various shades of color used for the water and foliage represent the tropical nature of the city.

Les différentes nuances de couleur utilisées pour l'eau et la feuillure représentent la nature tropicale de la ville.

Los diversos tonos de color usados para el agua y la vegetación representan la naturaleza tropical de la ciudad.

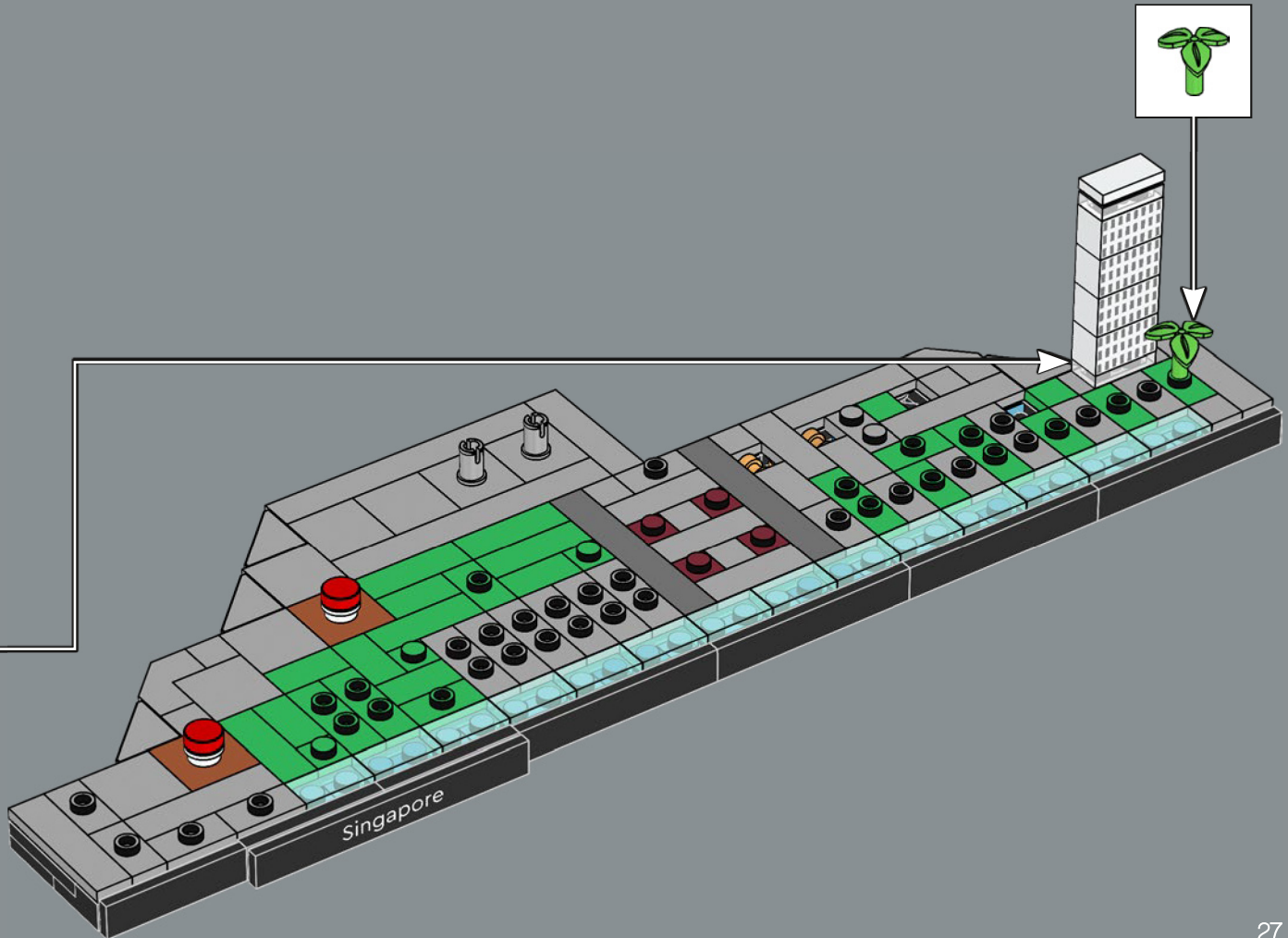

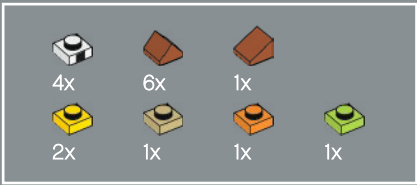

22

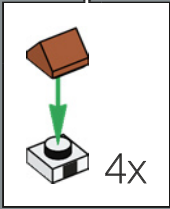
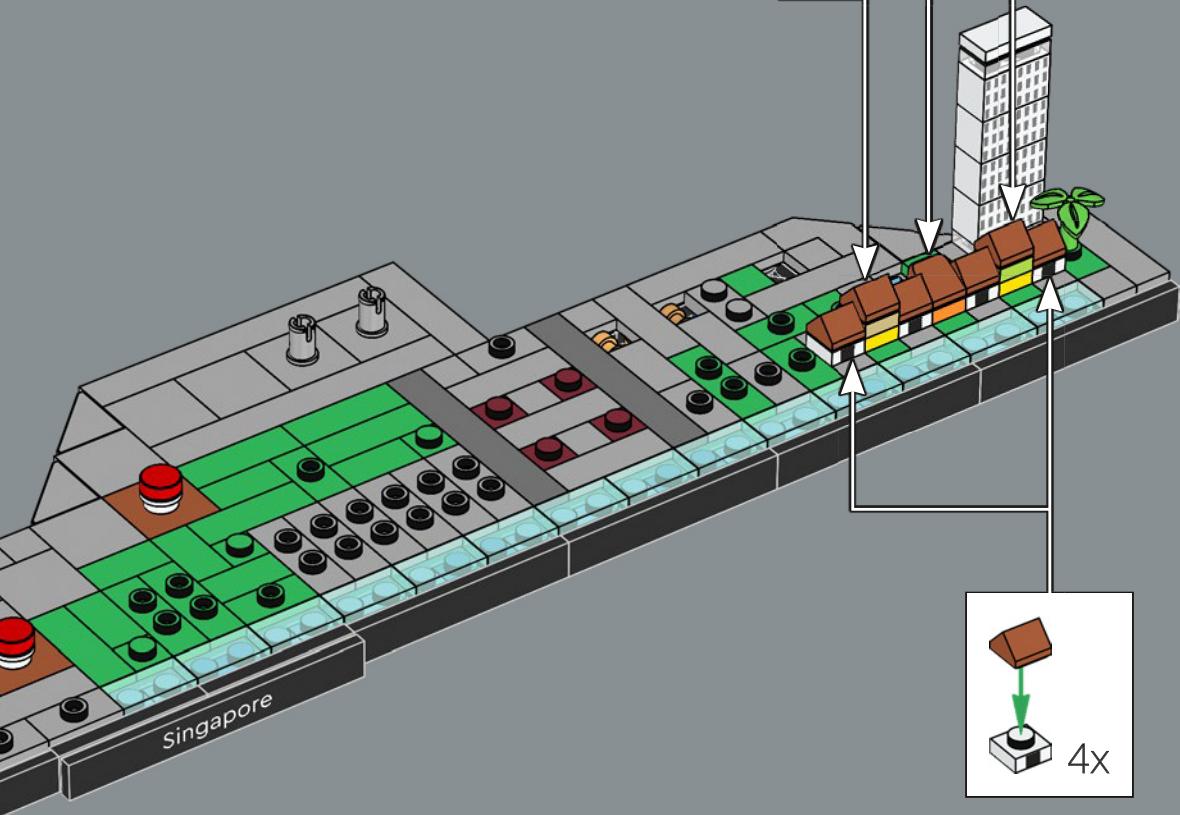
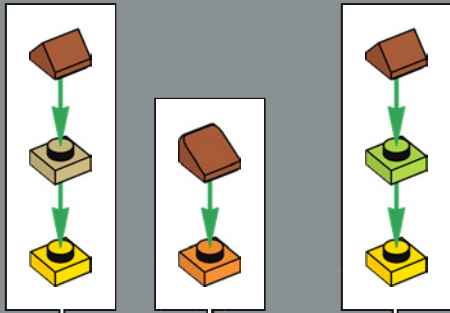



23

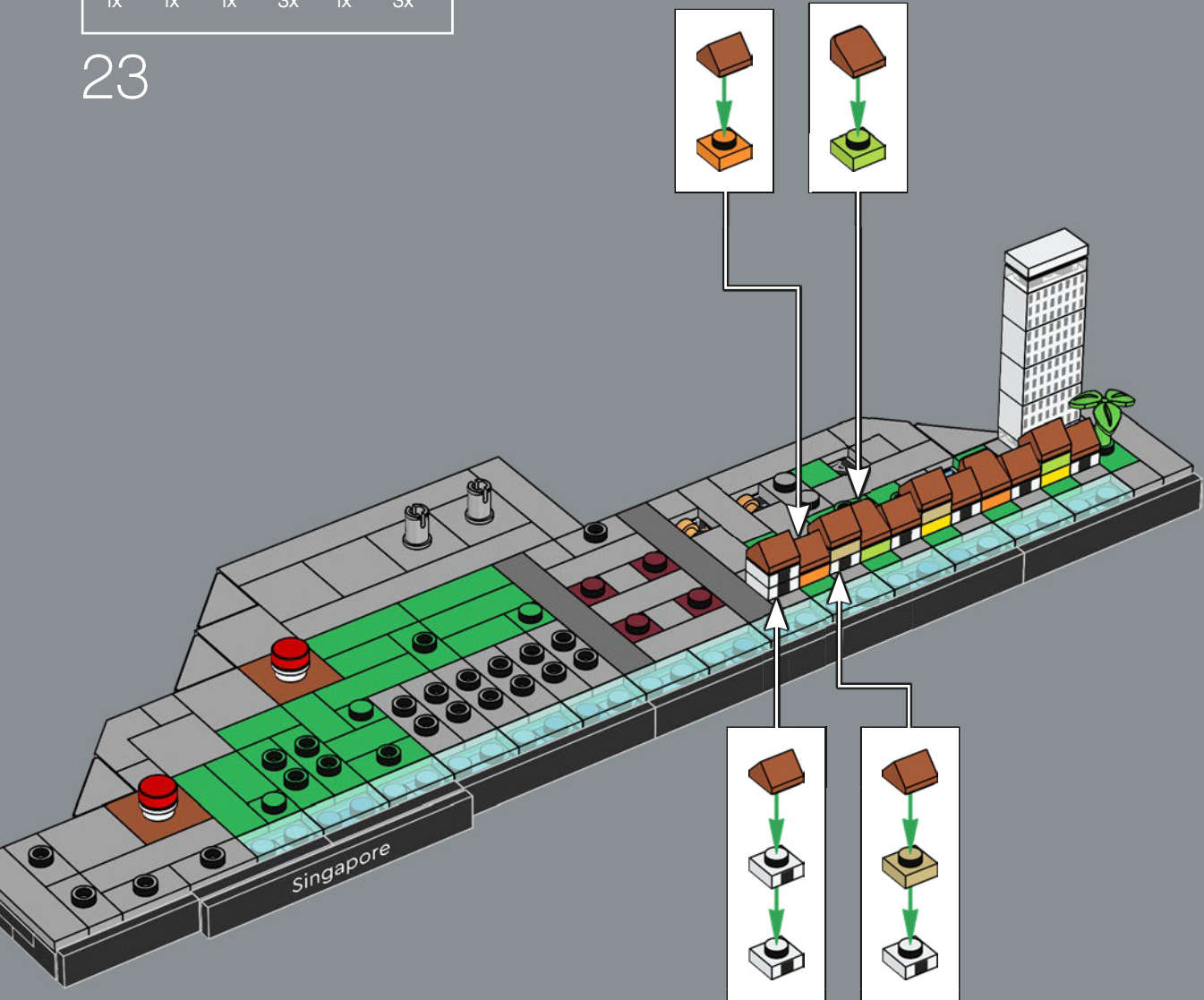

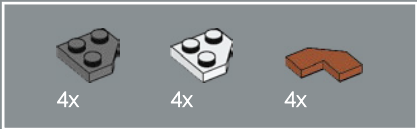

24

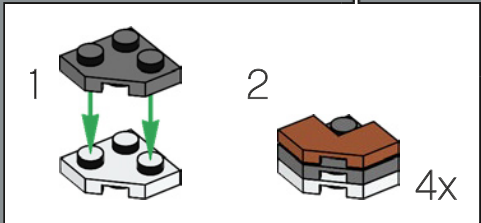
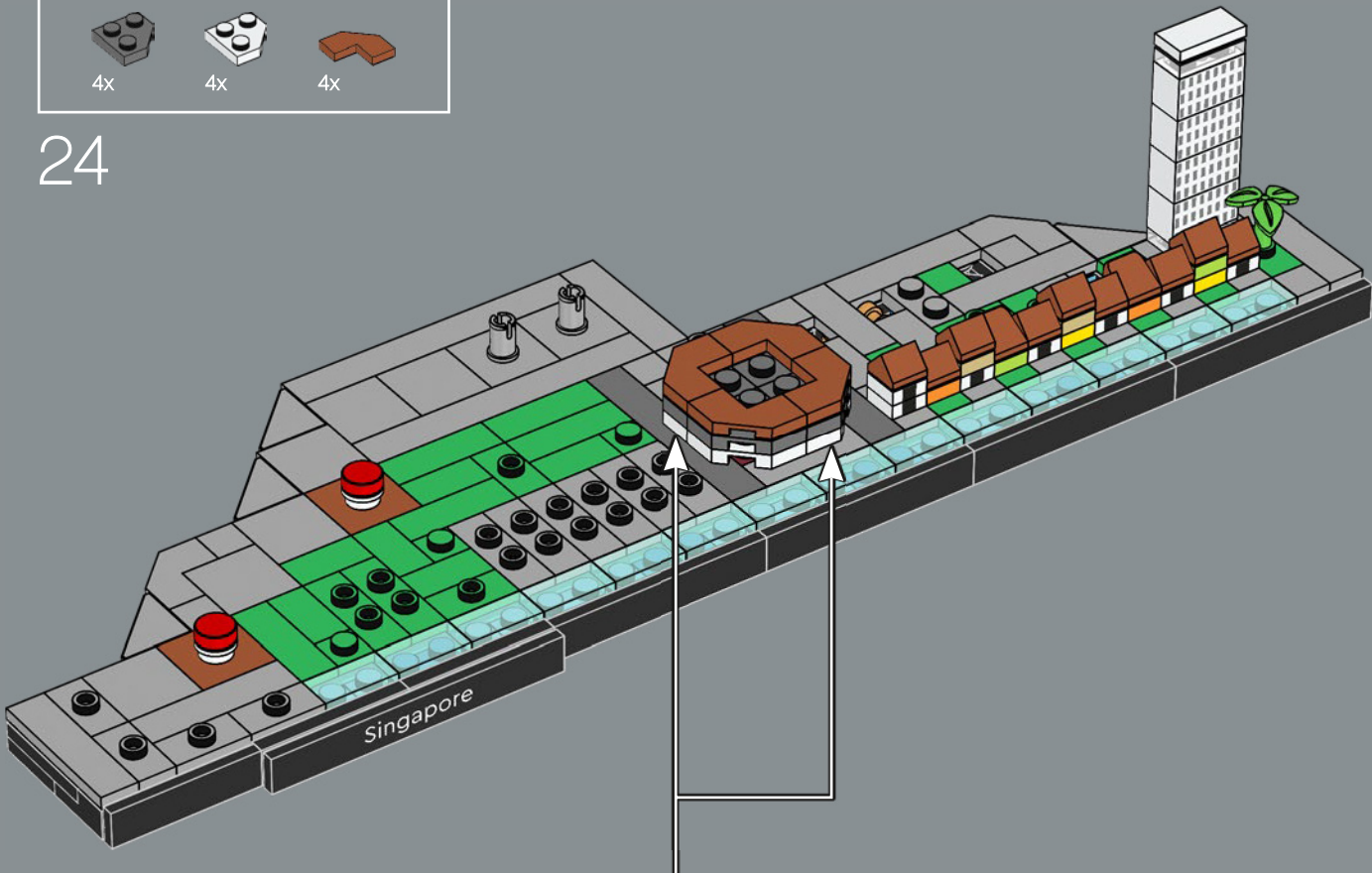

The cast-iron structure is also known as *pasar besi* (*market of iron*) in the Malay language.

La structure en fonte est également connue sous le nom de *pasar besi* (« marché du fer ») en langue malaise.

La estructura de hierro fundido se conoce también como *pasar besi* (mercado de hierro, en malayo).

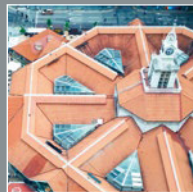

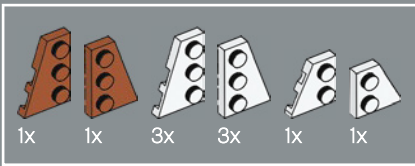

25

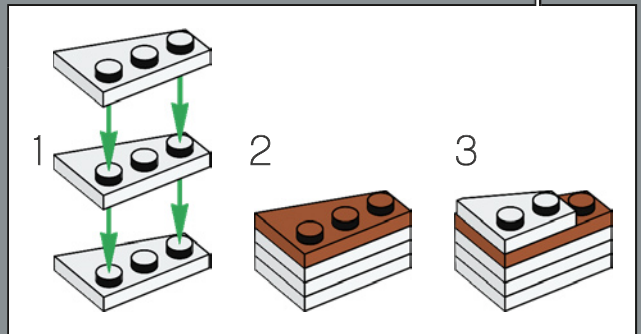
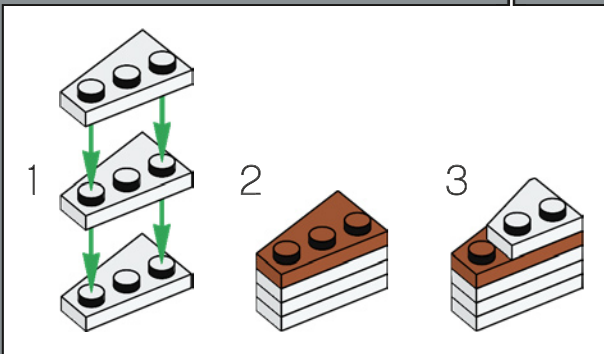
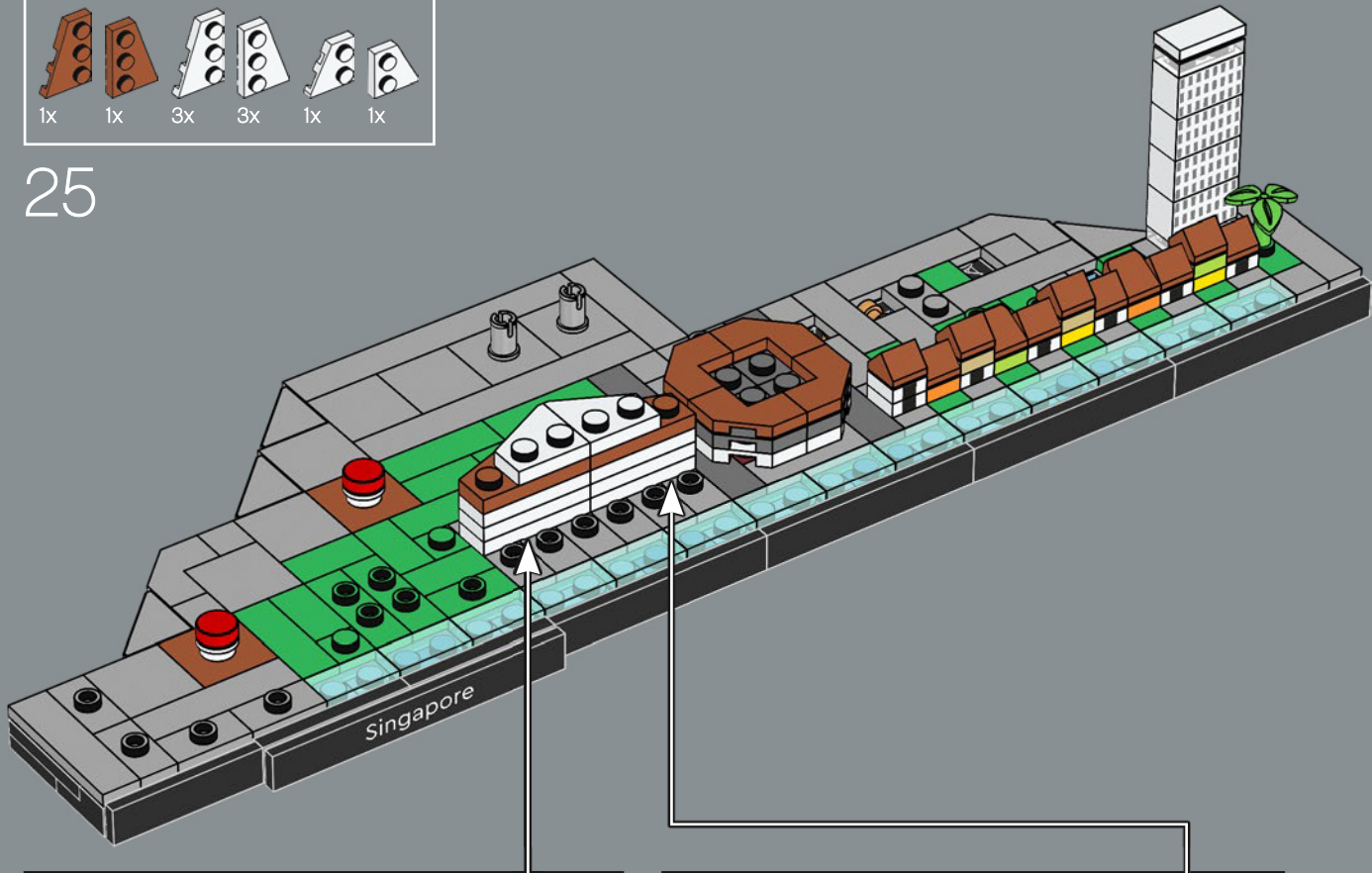

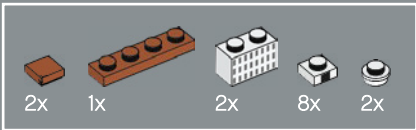

26

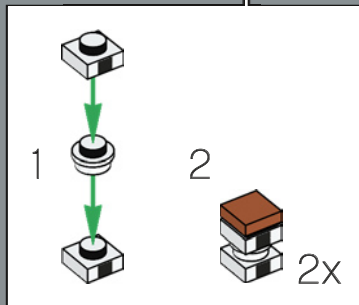
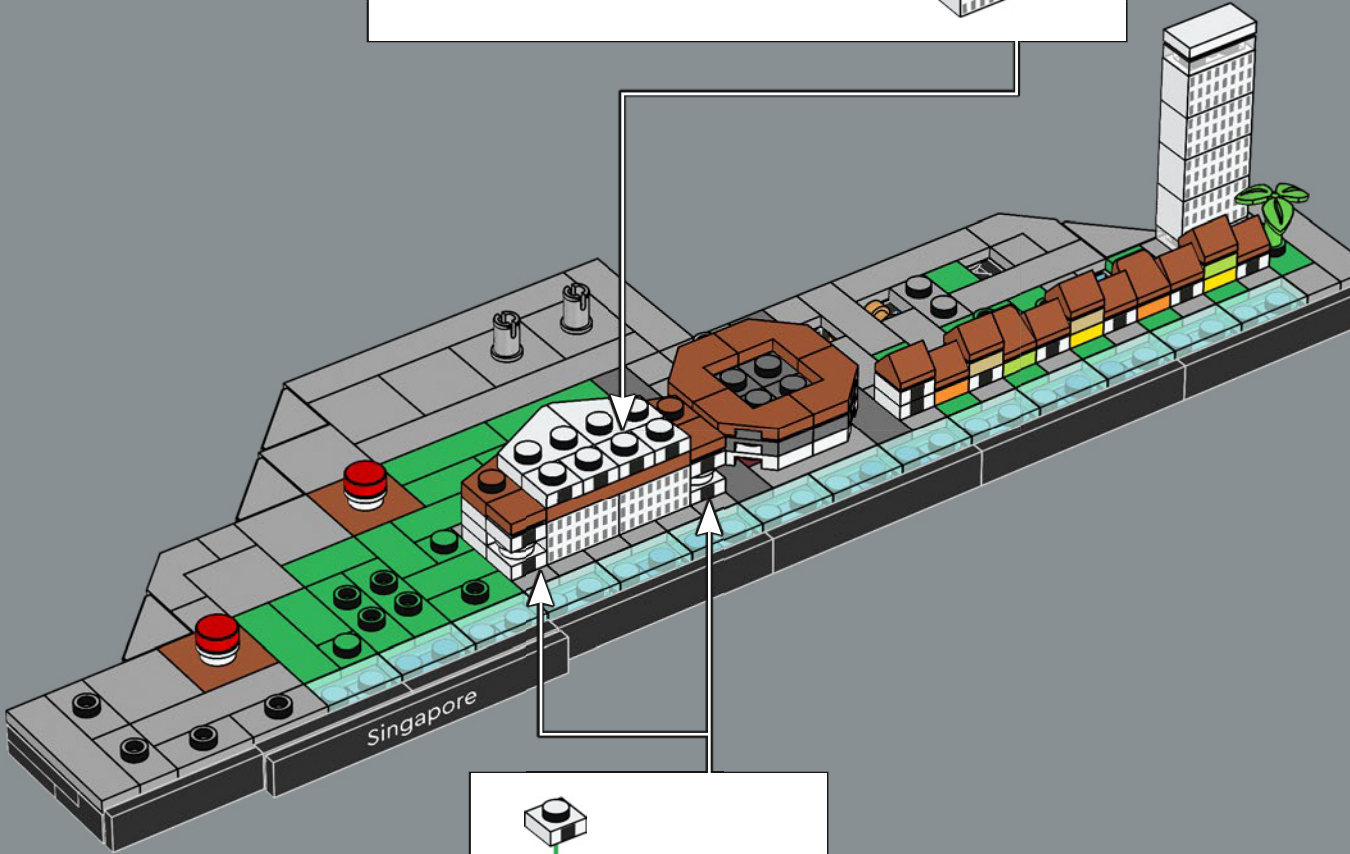
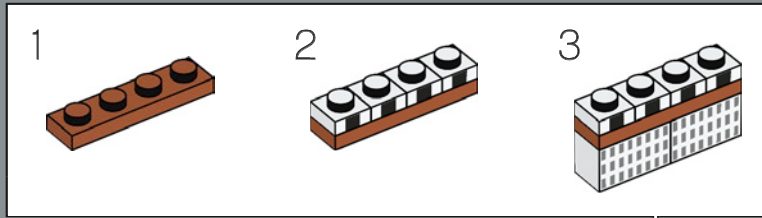



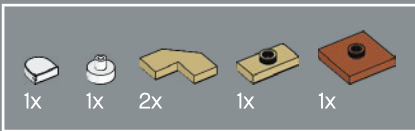

27



The historic structure was designated a National Monument of Singapore on February 10<sup>th</sup>, 2003.

La structure historique a été déclarée monument national de Singapour le 10 février 2003.

La histórica estructura fue declarada monumento nacional de Singapur el 10 de febrero de 2003.

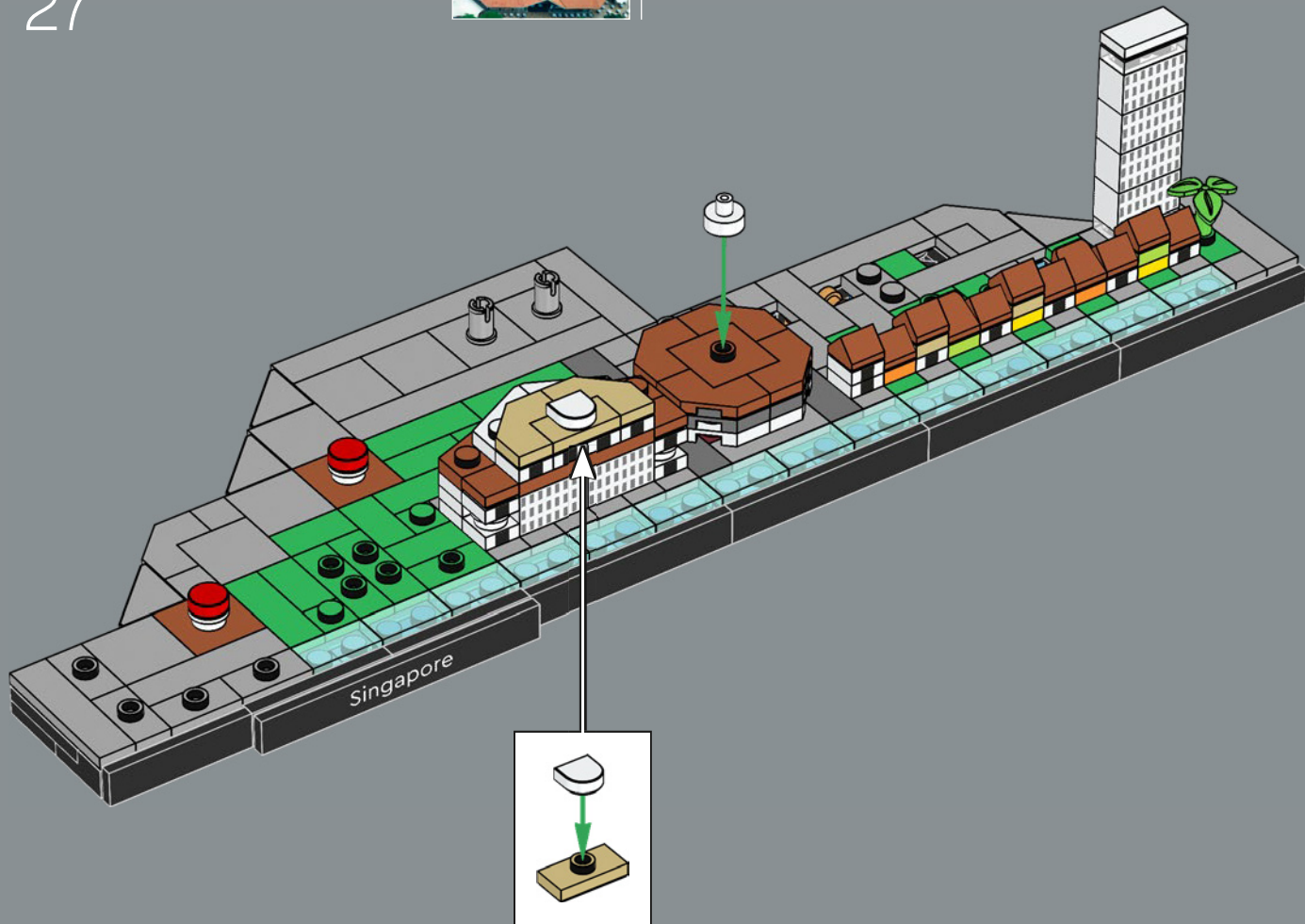



28

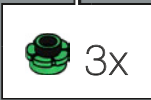
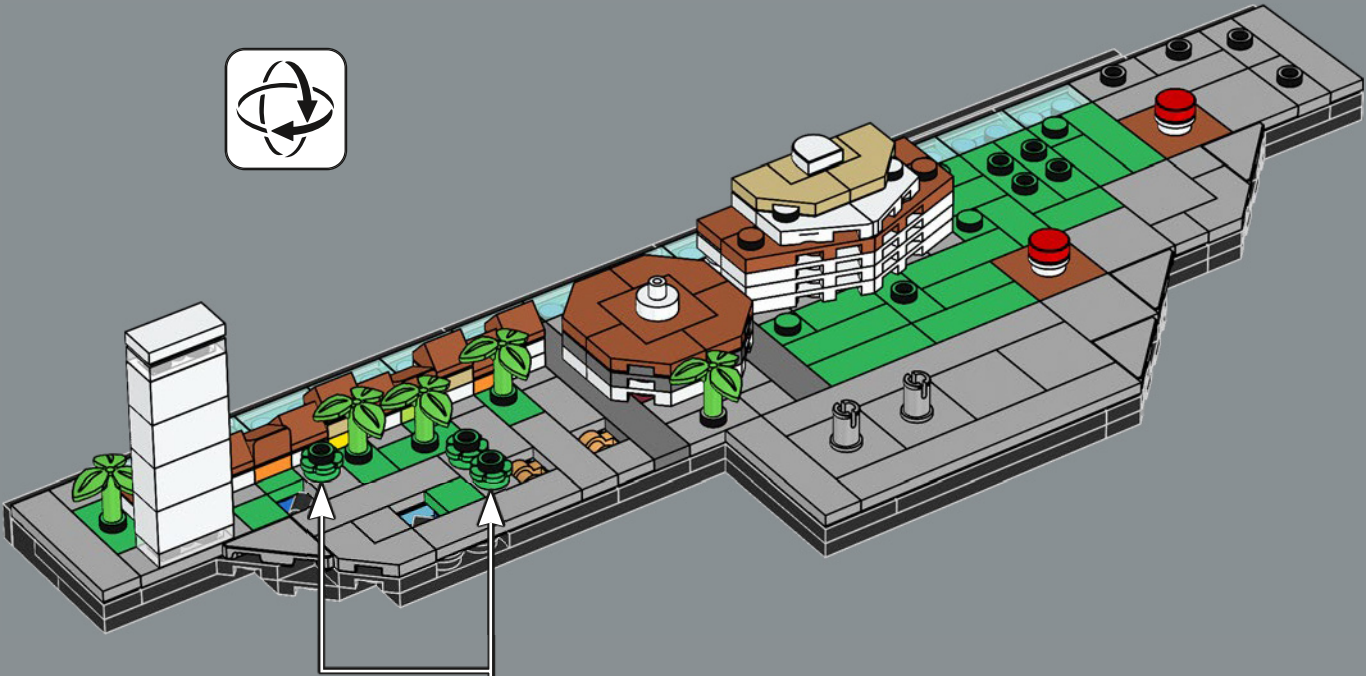

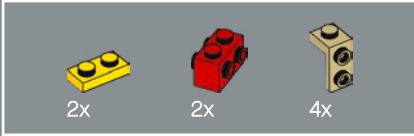
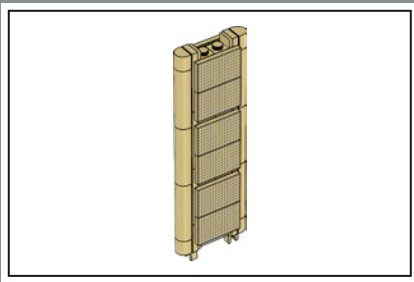

29

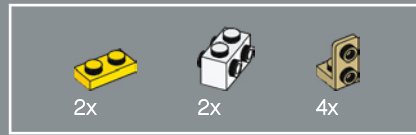
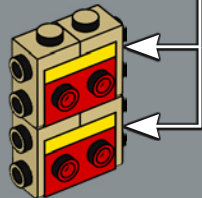
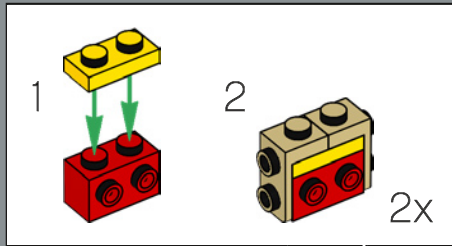

30

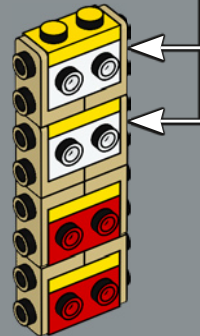
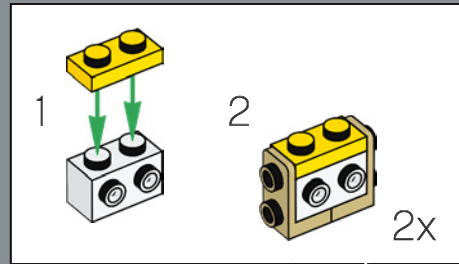



31

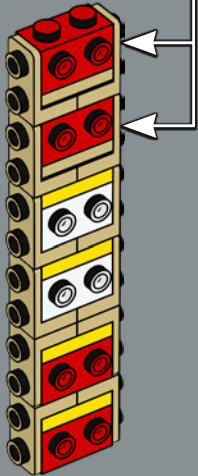
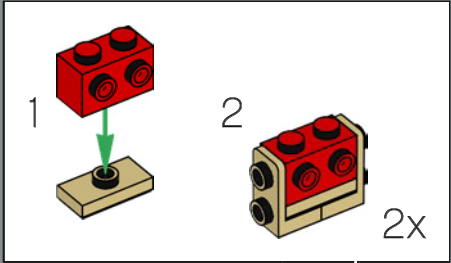

32



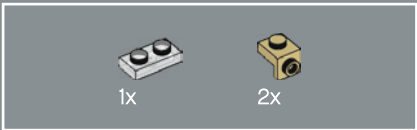

33

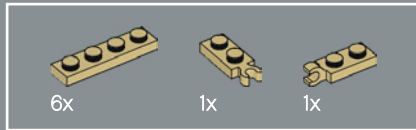
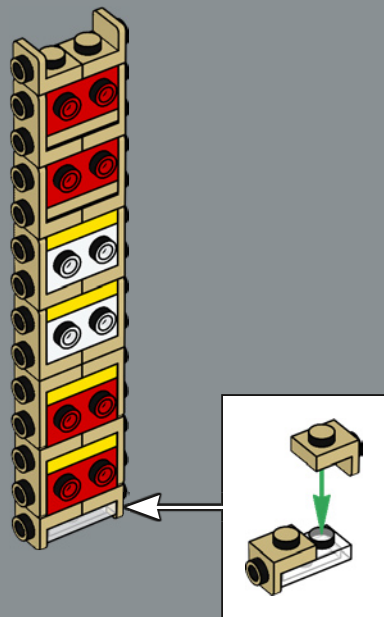

34

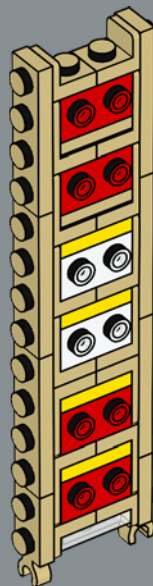



35

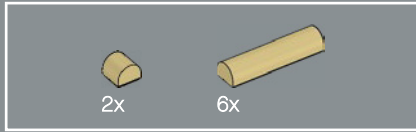
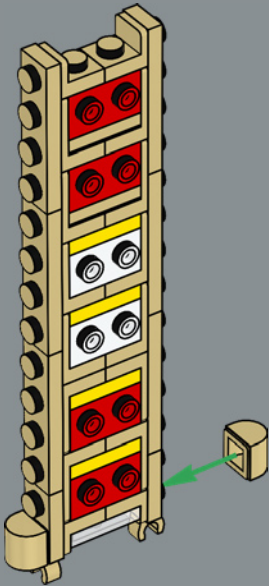

36

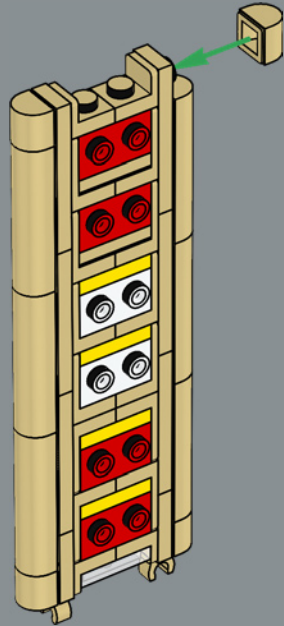

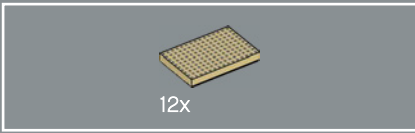

37



The LEGO® version of the OCBC Centre is a good example of sideways LEGO building.

La versión LEGO® de l'OCBC Centre est un bon exemple de construction LEGO latérale.

La versión LEGO® del OCBC Centre es un buen ejemplo de la técnica de construcción LEGO lateral.

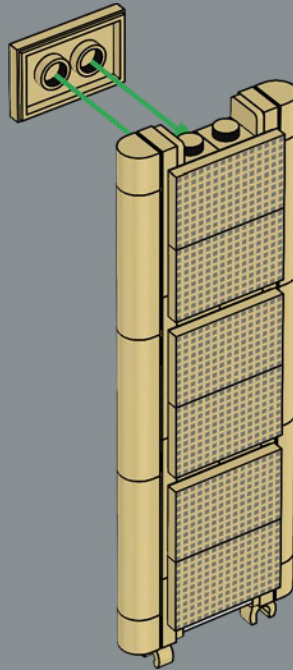

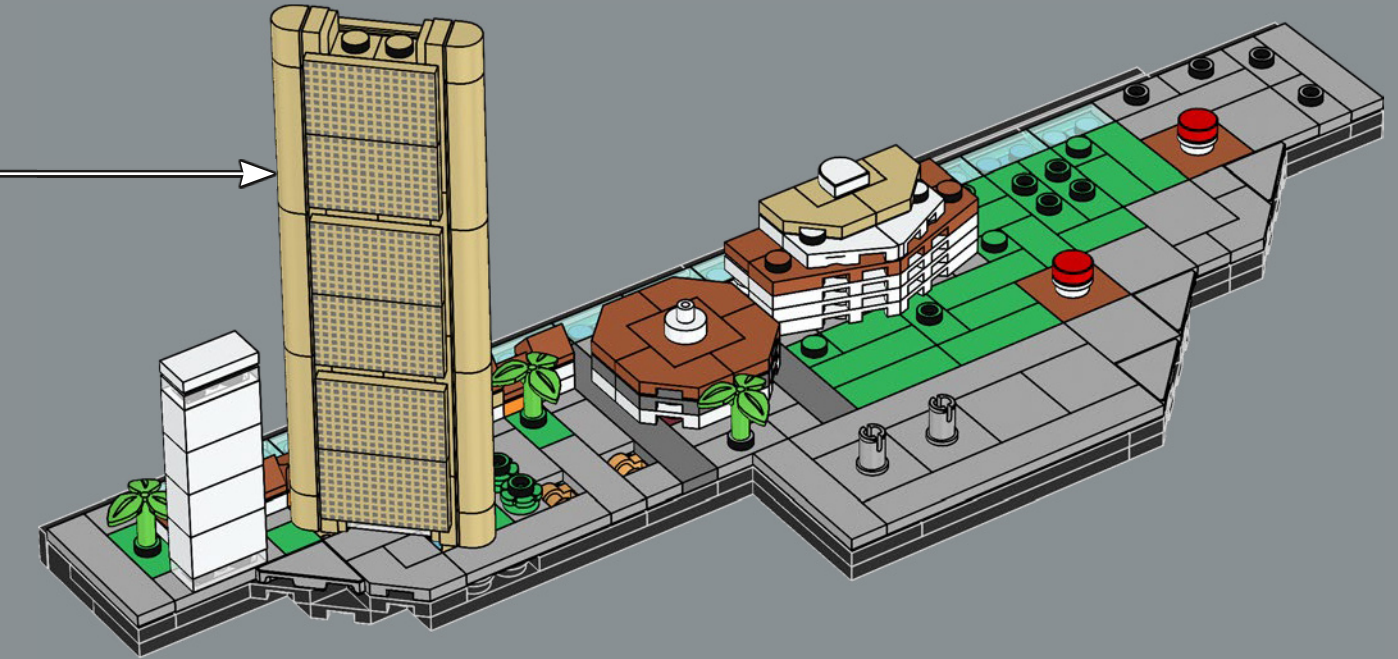



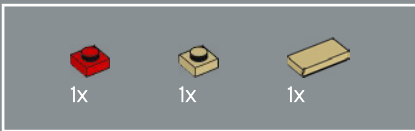

39

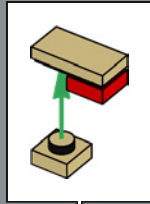

The OCBC Centre is nicknamed "The Calculator," due to its flat shape and windows that look like button pads.

L'OCBC Centre est surnommé « la calculatrice » en raison de sa forme plate et de ses fenêtres qui ressemblent à des touches.

El OCBC Centre recibe el apodo de "la Calculadora" por su forma plana y por sus ventanas, que parecen teclas.

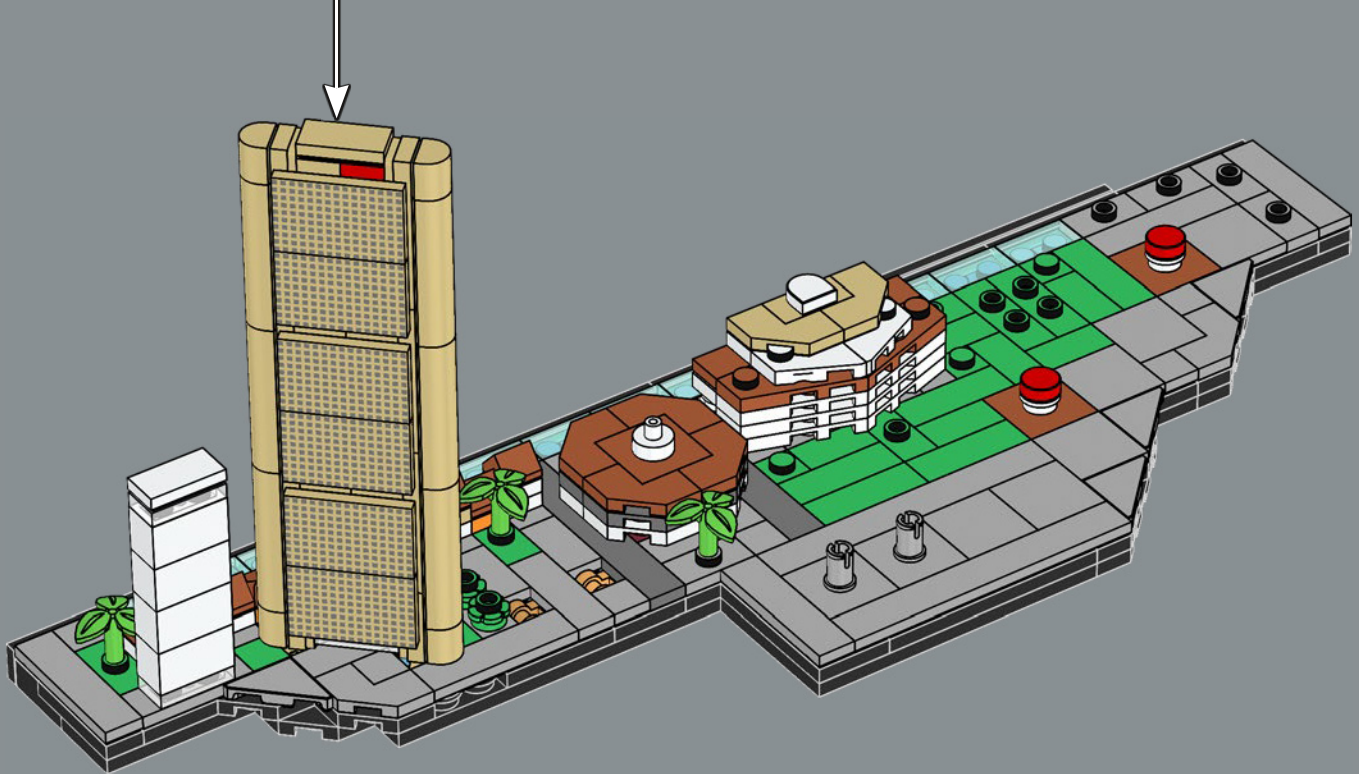

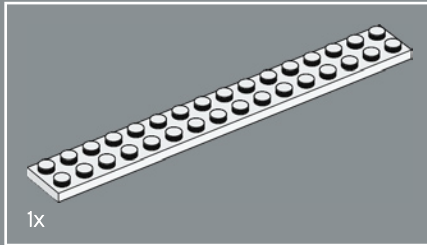
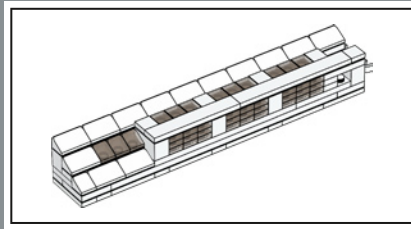
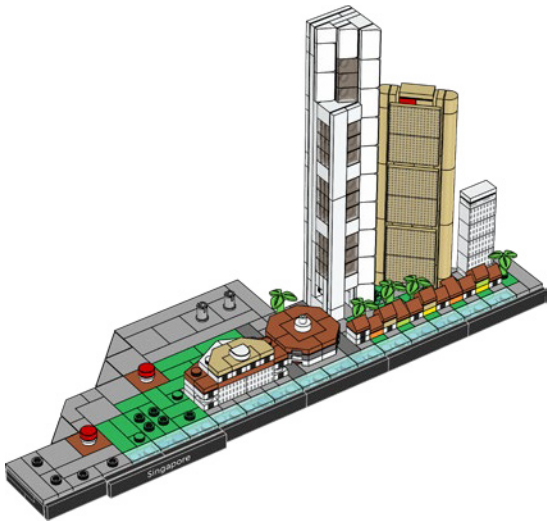
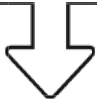

40

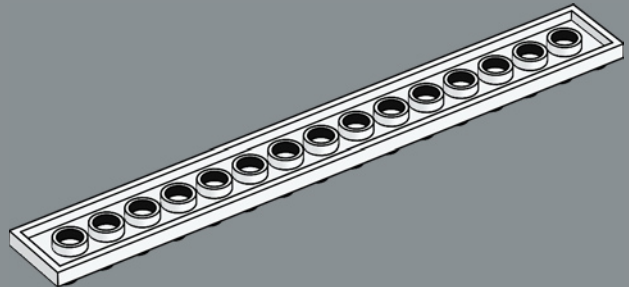

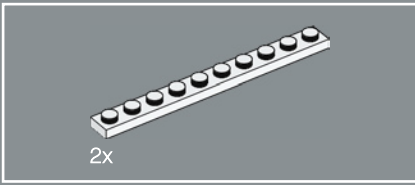

41

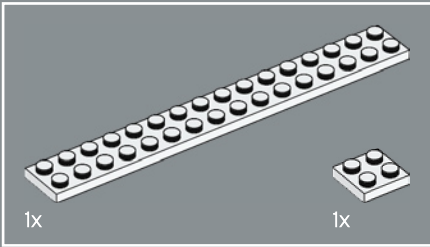
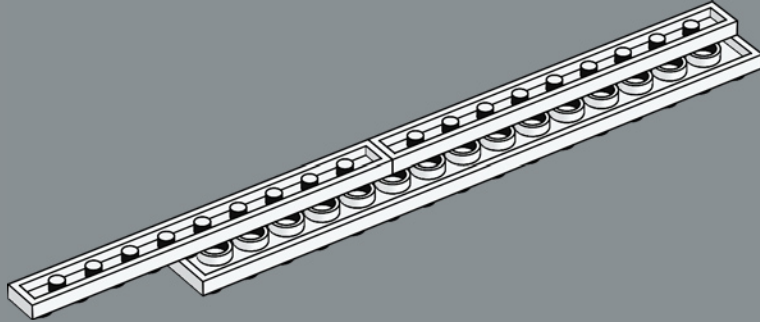

42

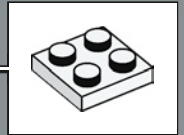
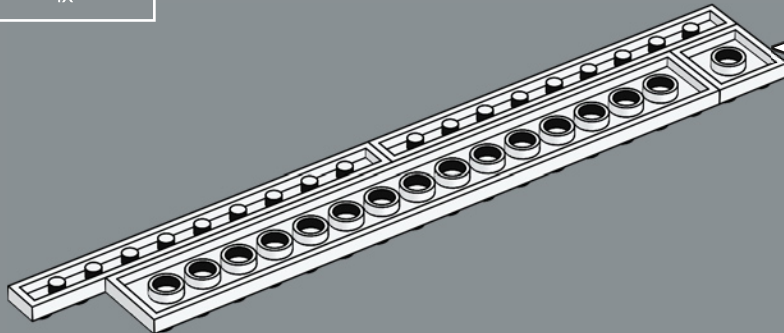

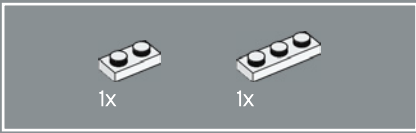

43

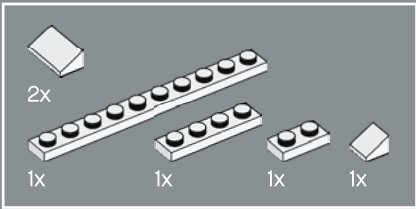
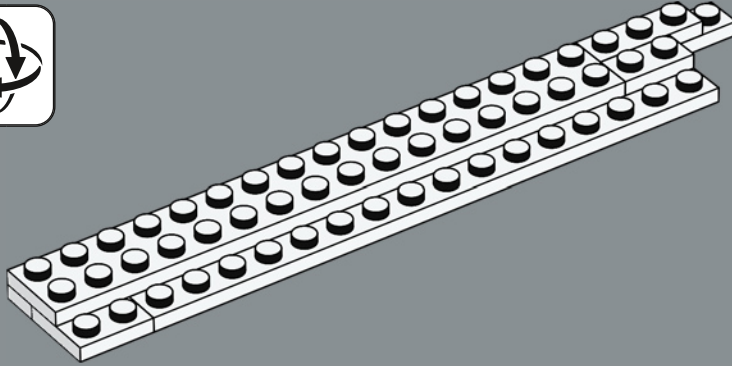

44

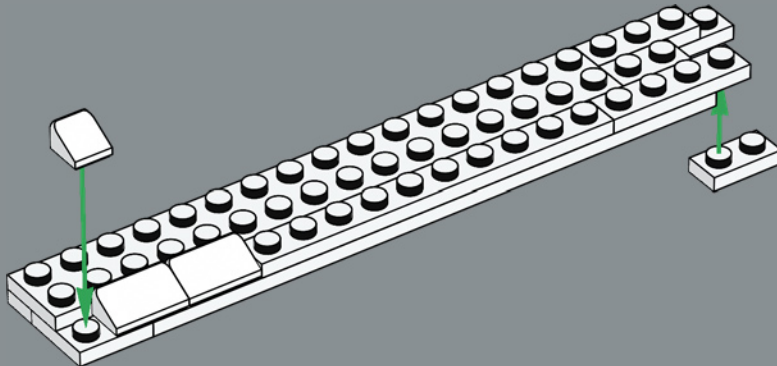

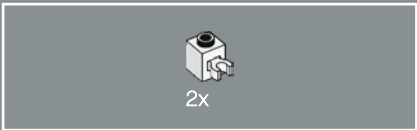

45

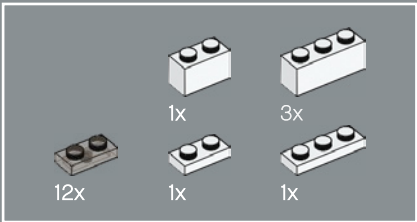
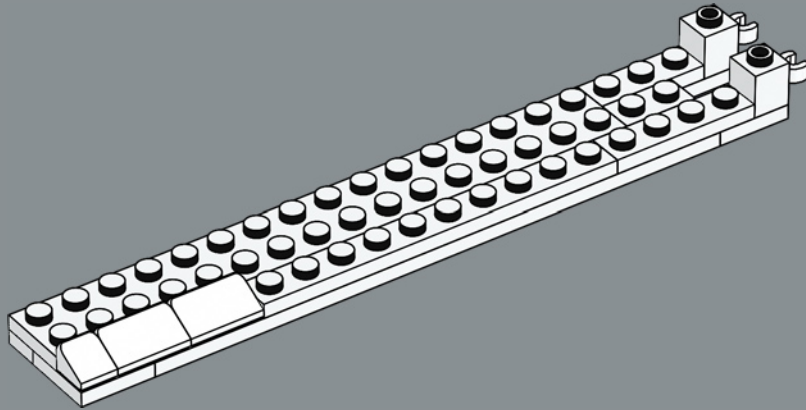

46

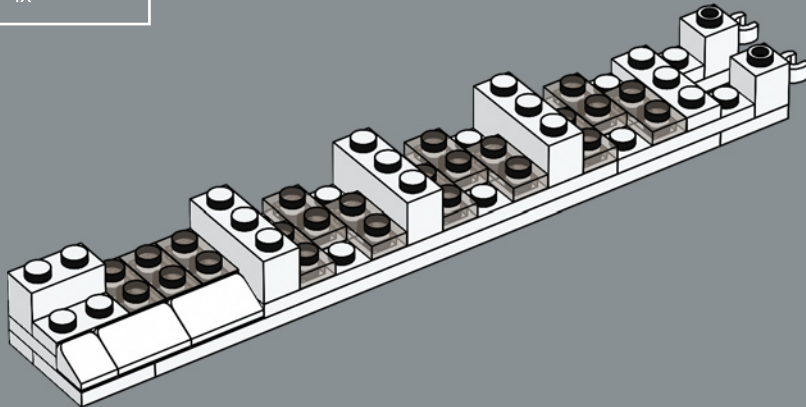

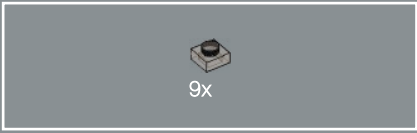

47

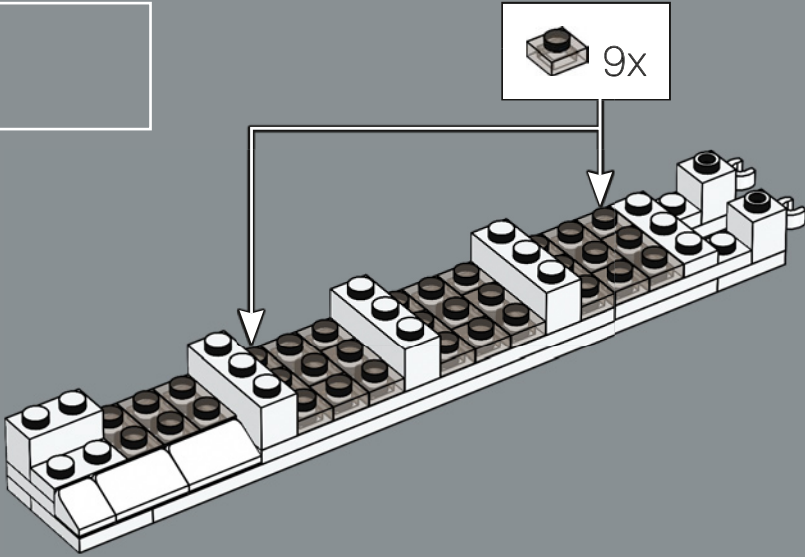

48

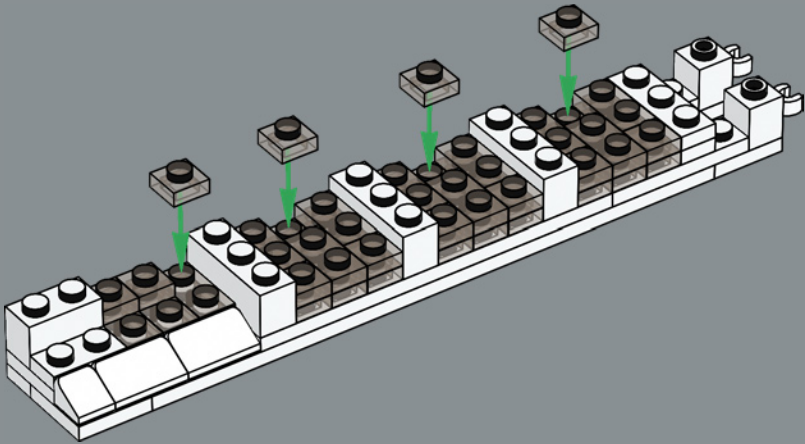

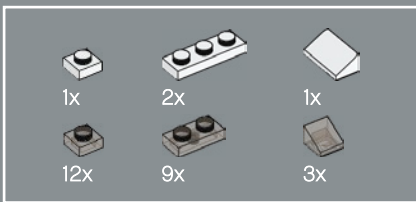

49

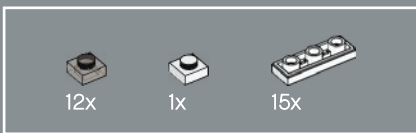
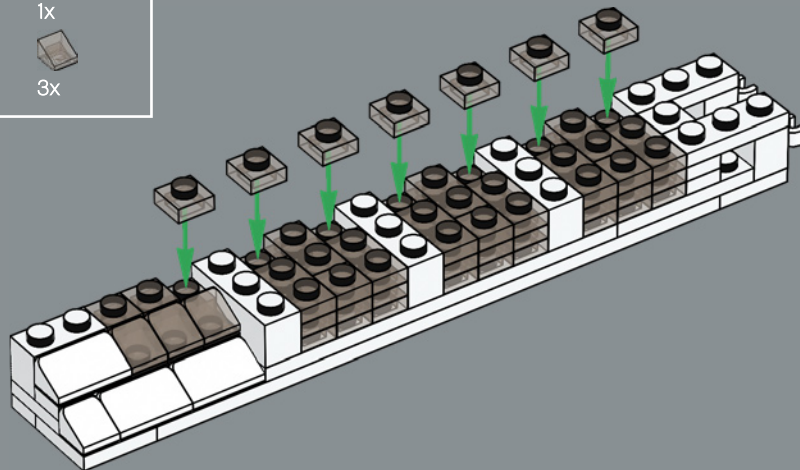

50

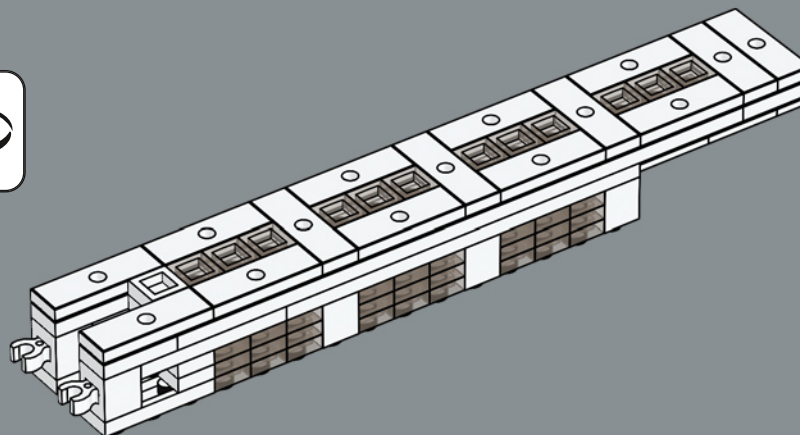

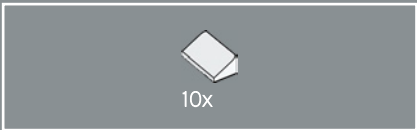

51

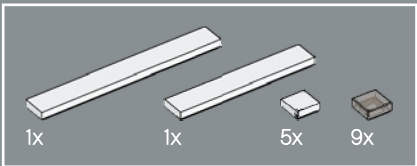
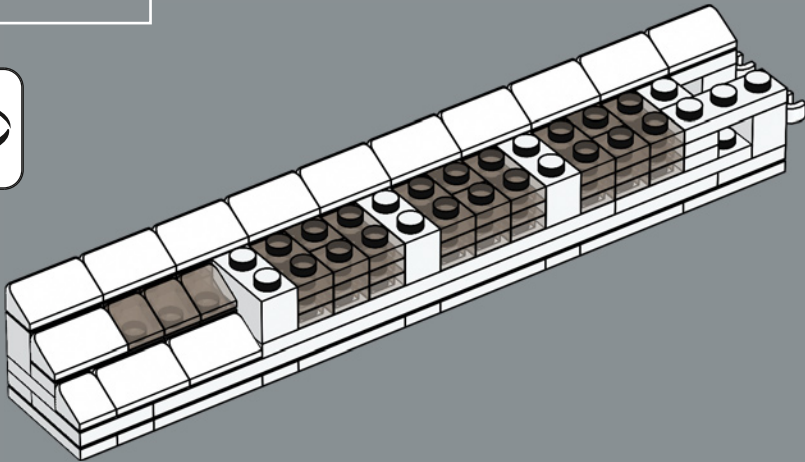

52

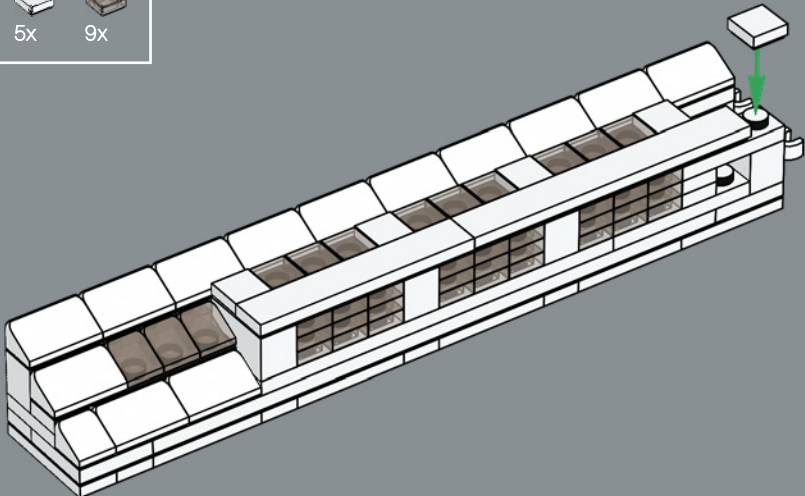



One Raffles Place was the tallest skyscraper in the world outside the US and Canada when completed.

À son achèvement, le One Raffles Place était le plus haut gratte-ciel du monde en dehors des États-Unis et du Canada.

En el momento de su finalización, One Raffles Place era el rascacielos más alto del mundo fuera de los Estados Unidos y Canadá.

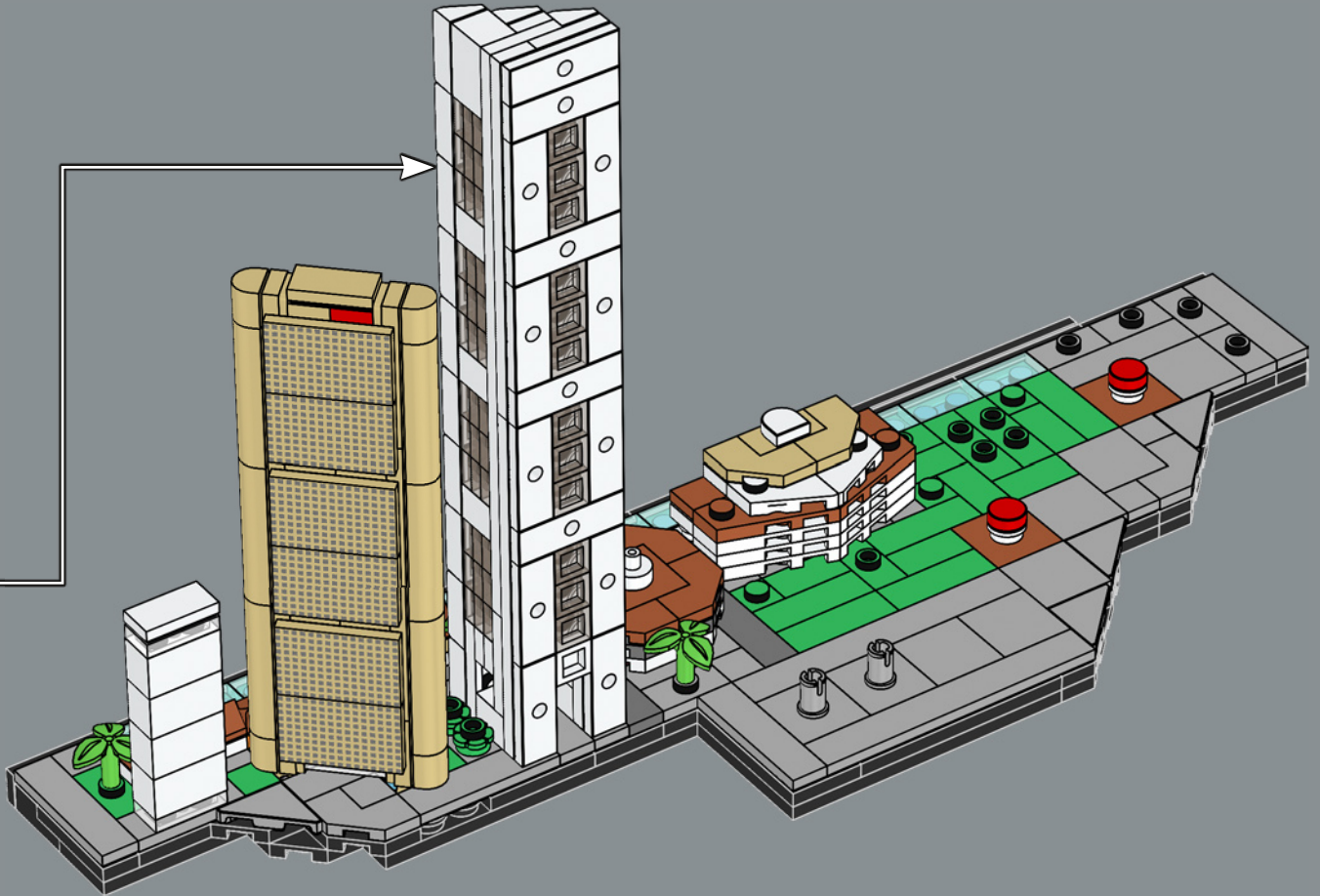

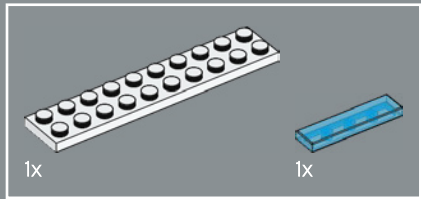
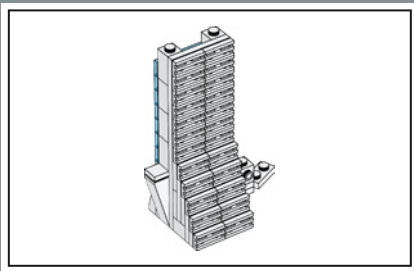
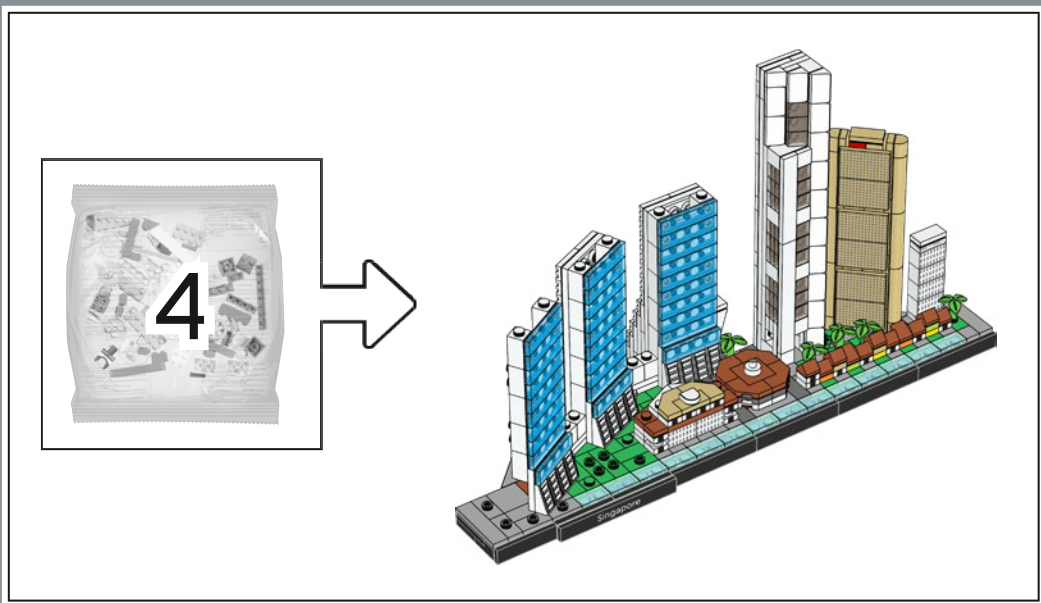

54

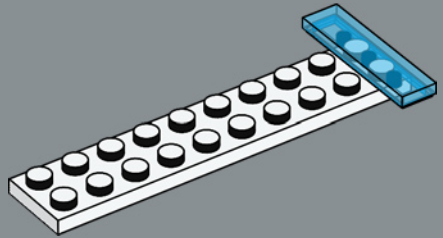

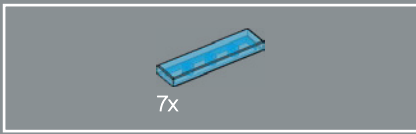

55

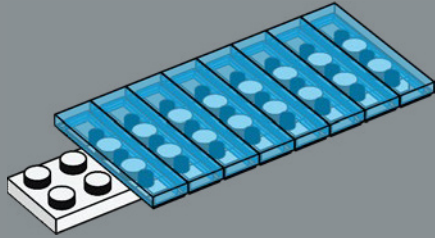

56

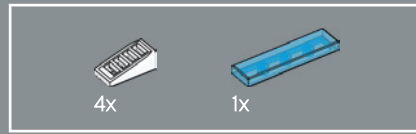
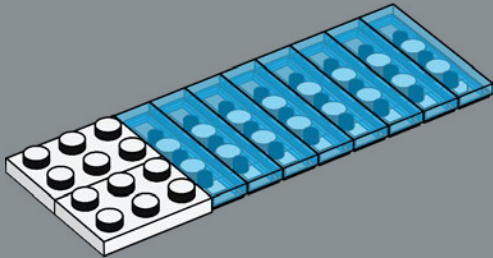

57

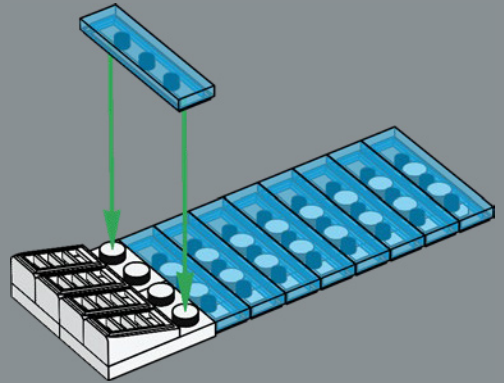

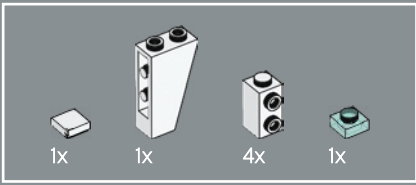

58

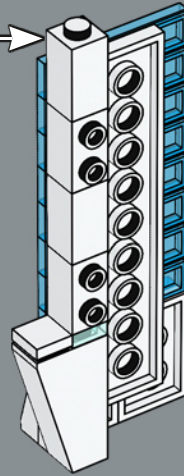
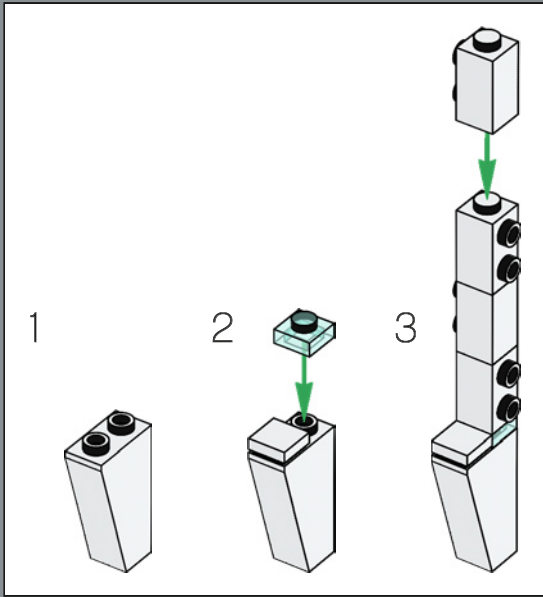

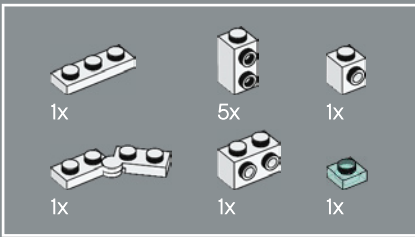

59

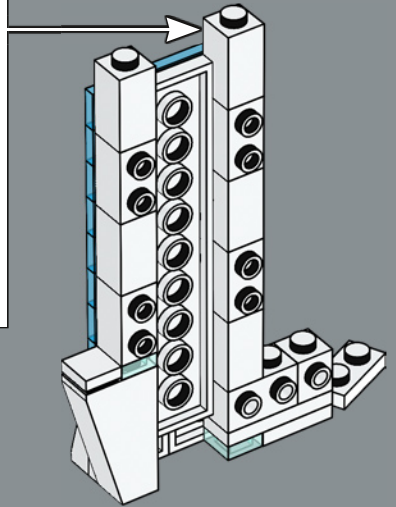
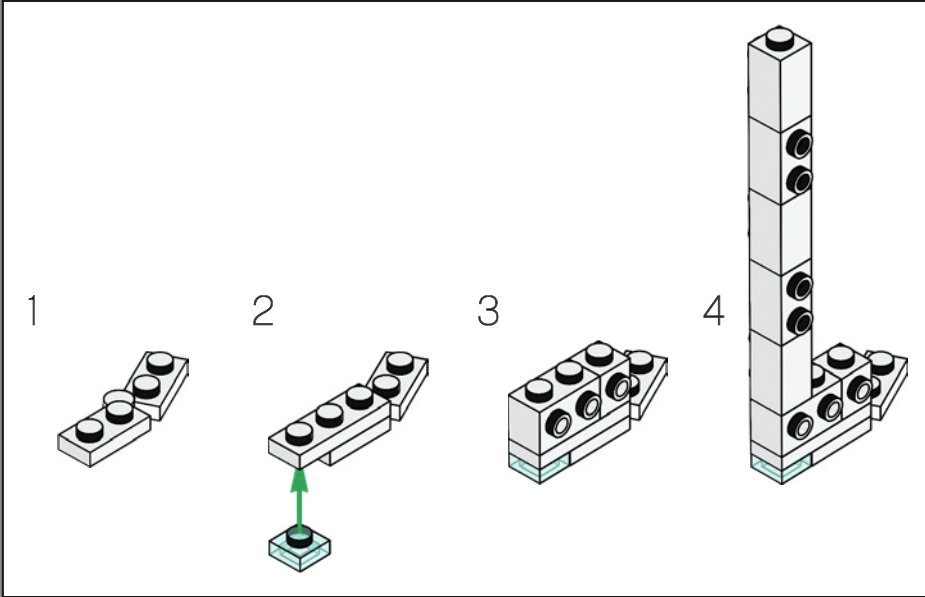



2x

60

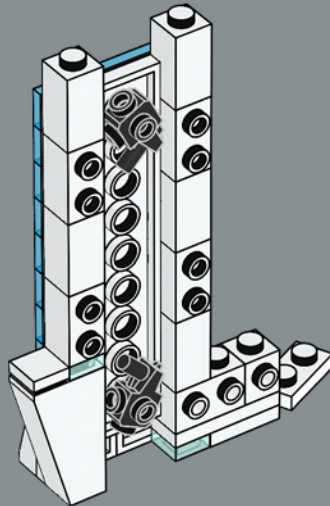

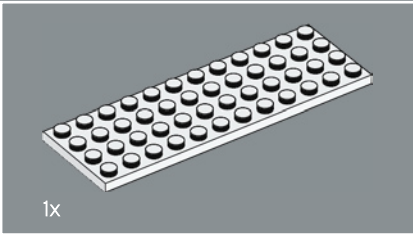
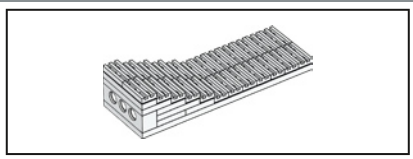

1x

61

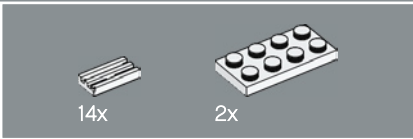
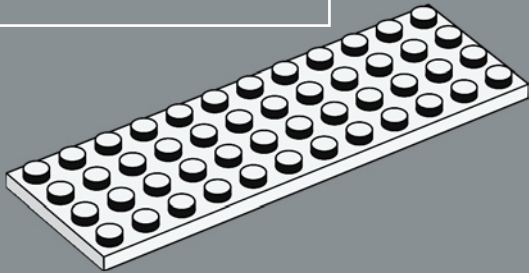

14x

2x

62

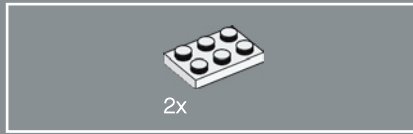
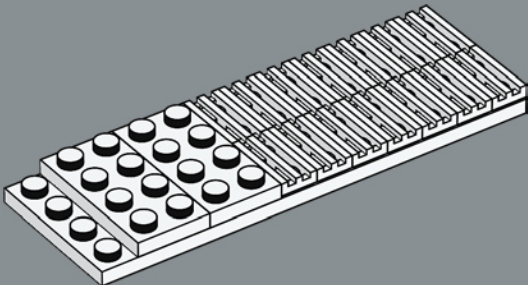

2x

63

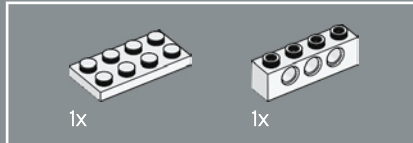
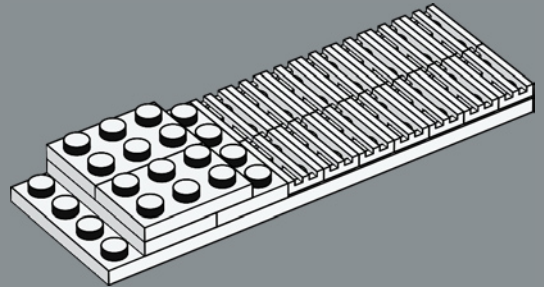

1x

1x

64

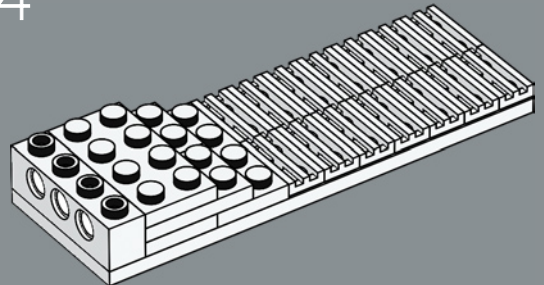

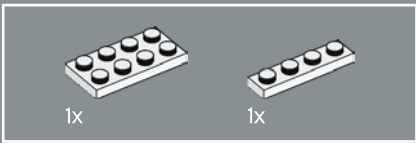

65

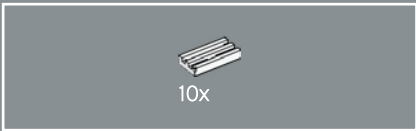
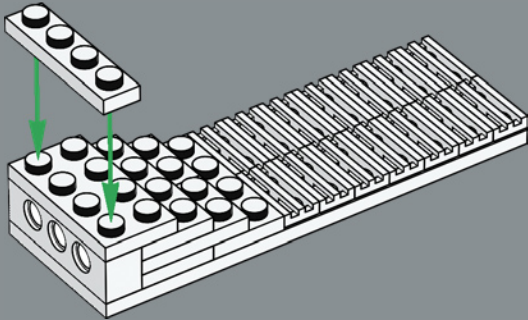

66

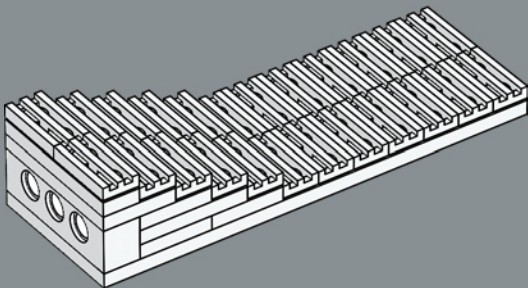

67

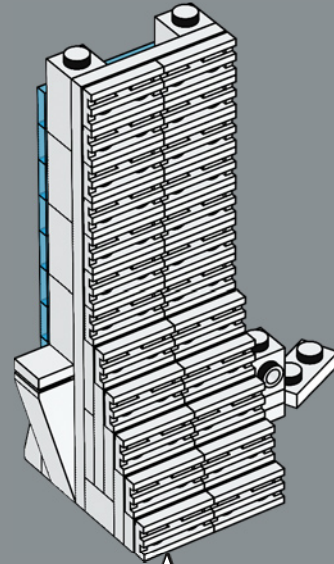



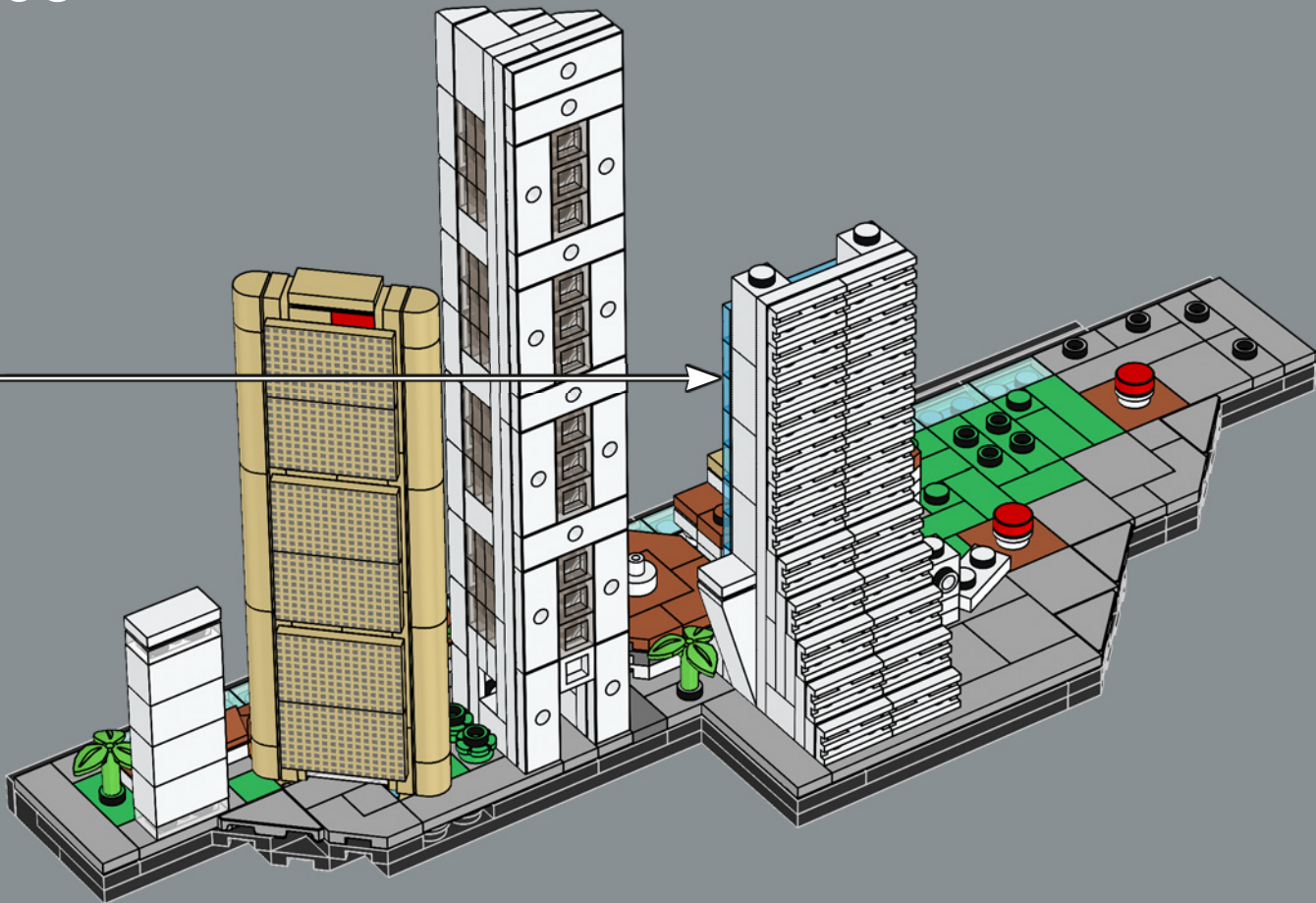

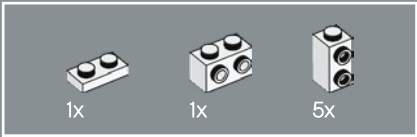

69

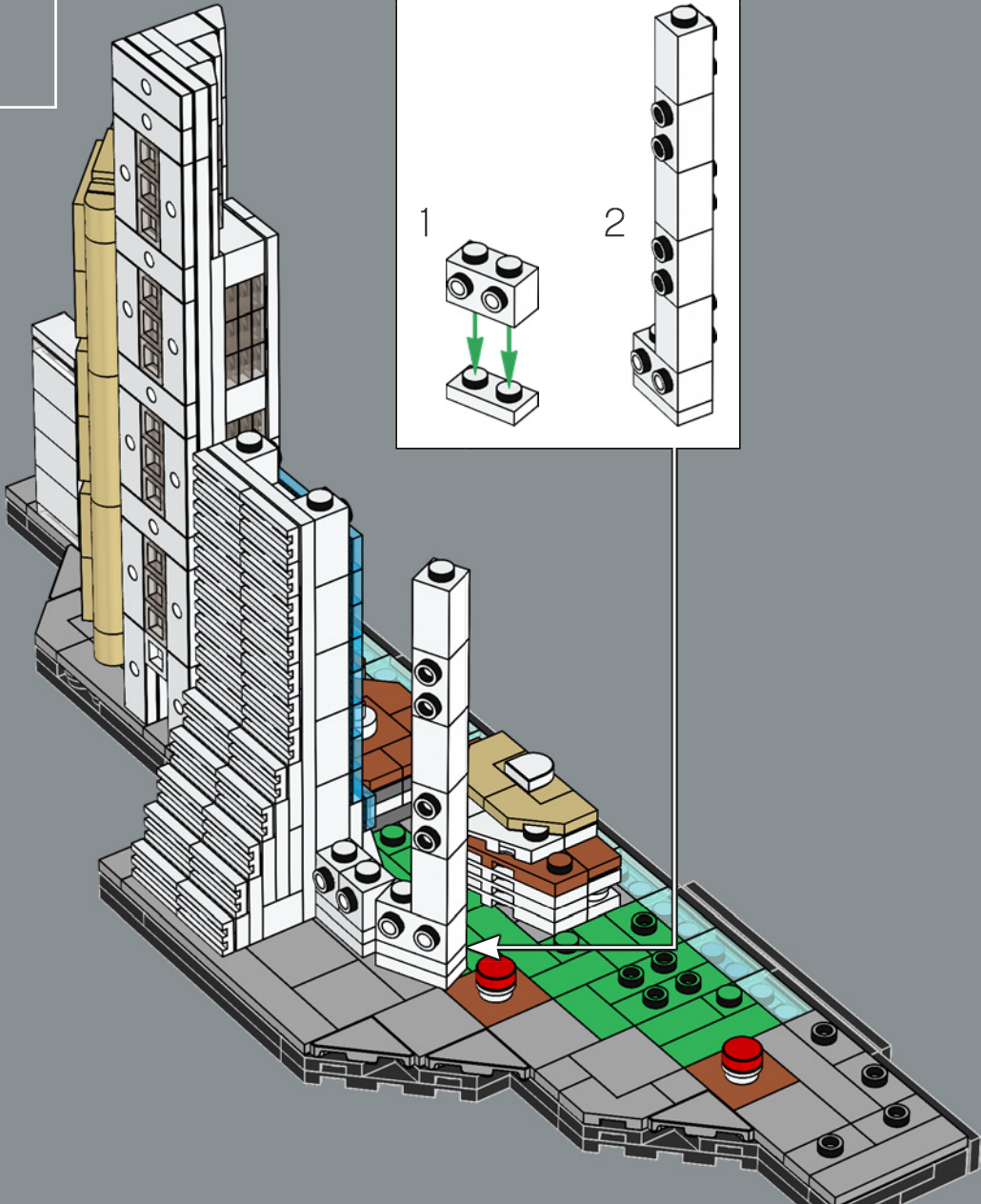
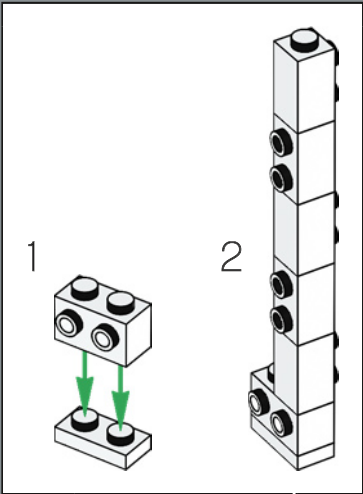

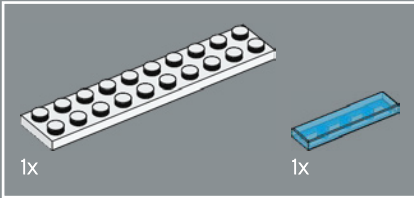
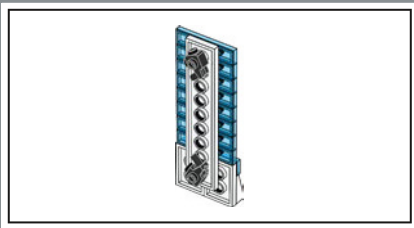

70

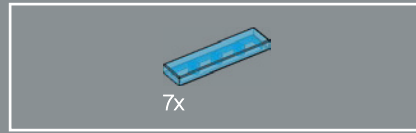
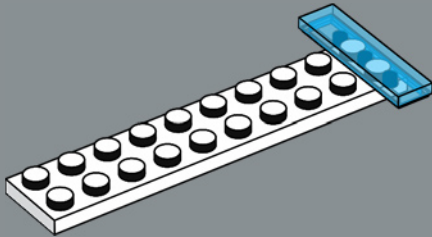

71

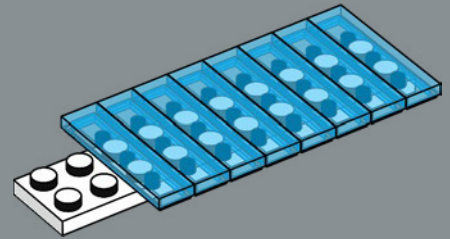

72

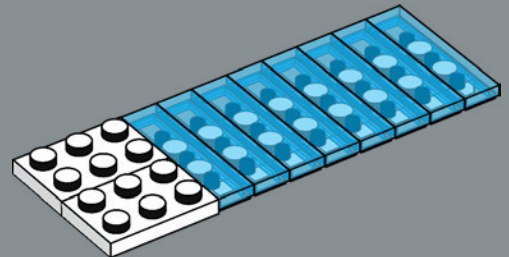

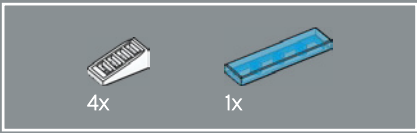

73

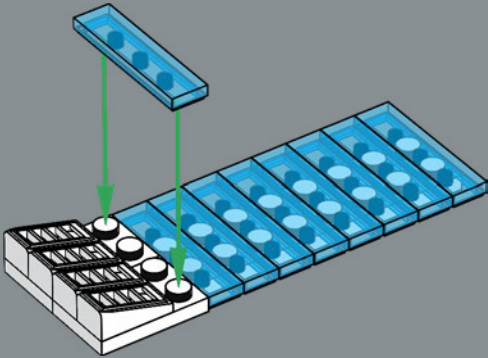

74

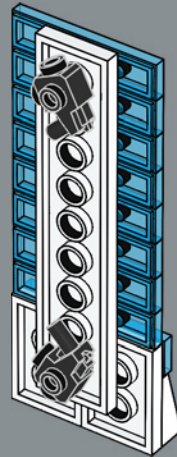

75

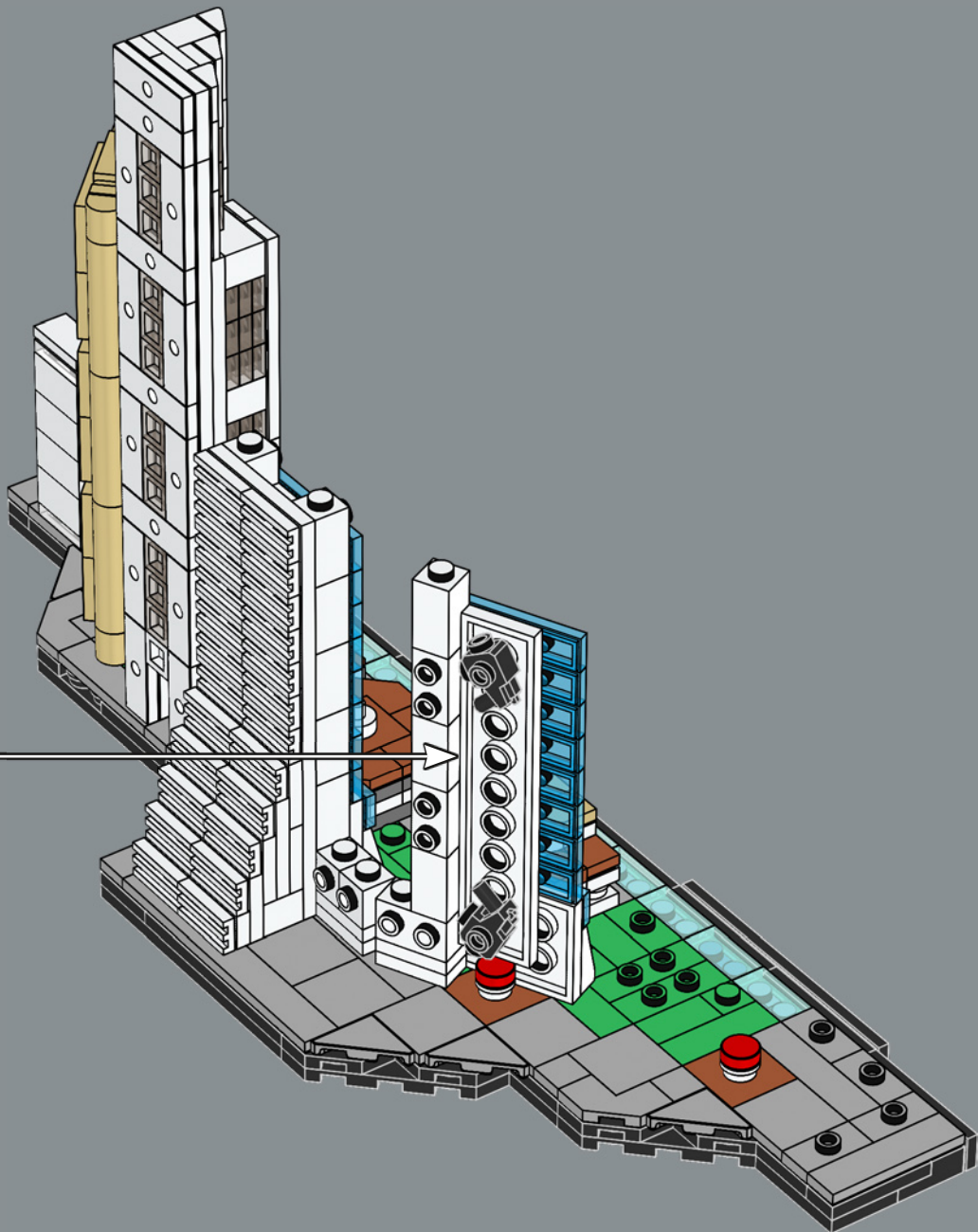

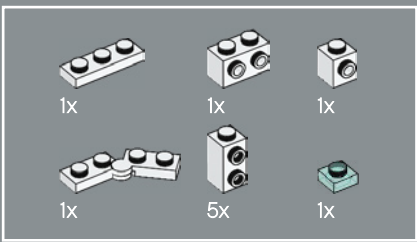

76

1

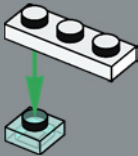

2



3

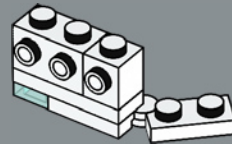

4

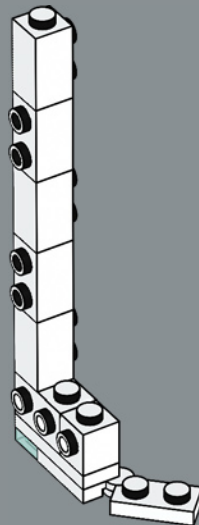

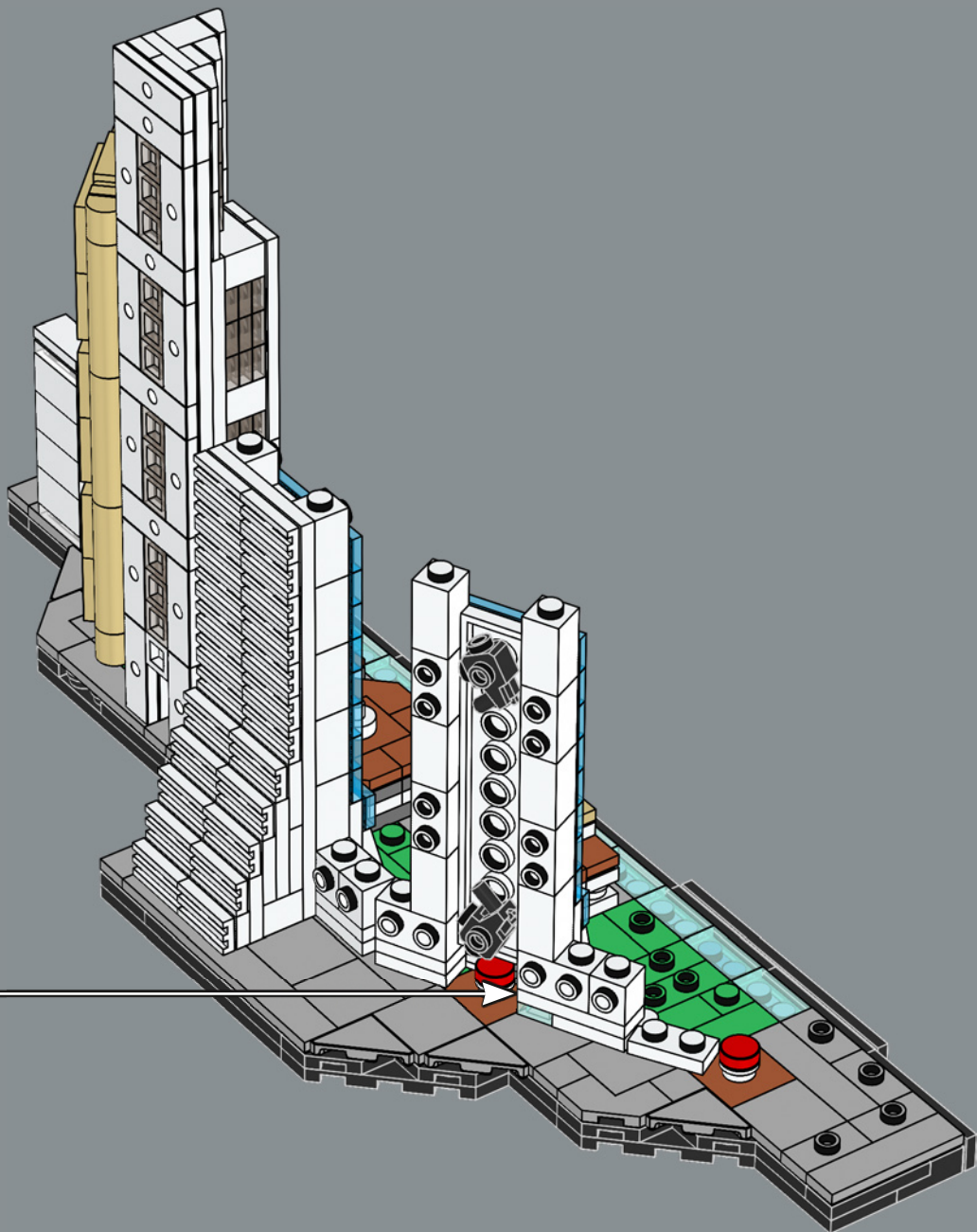





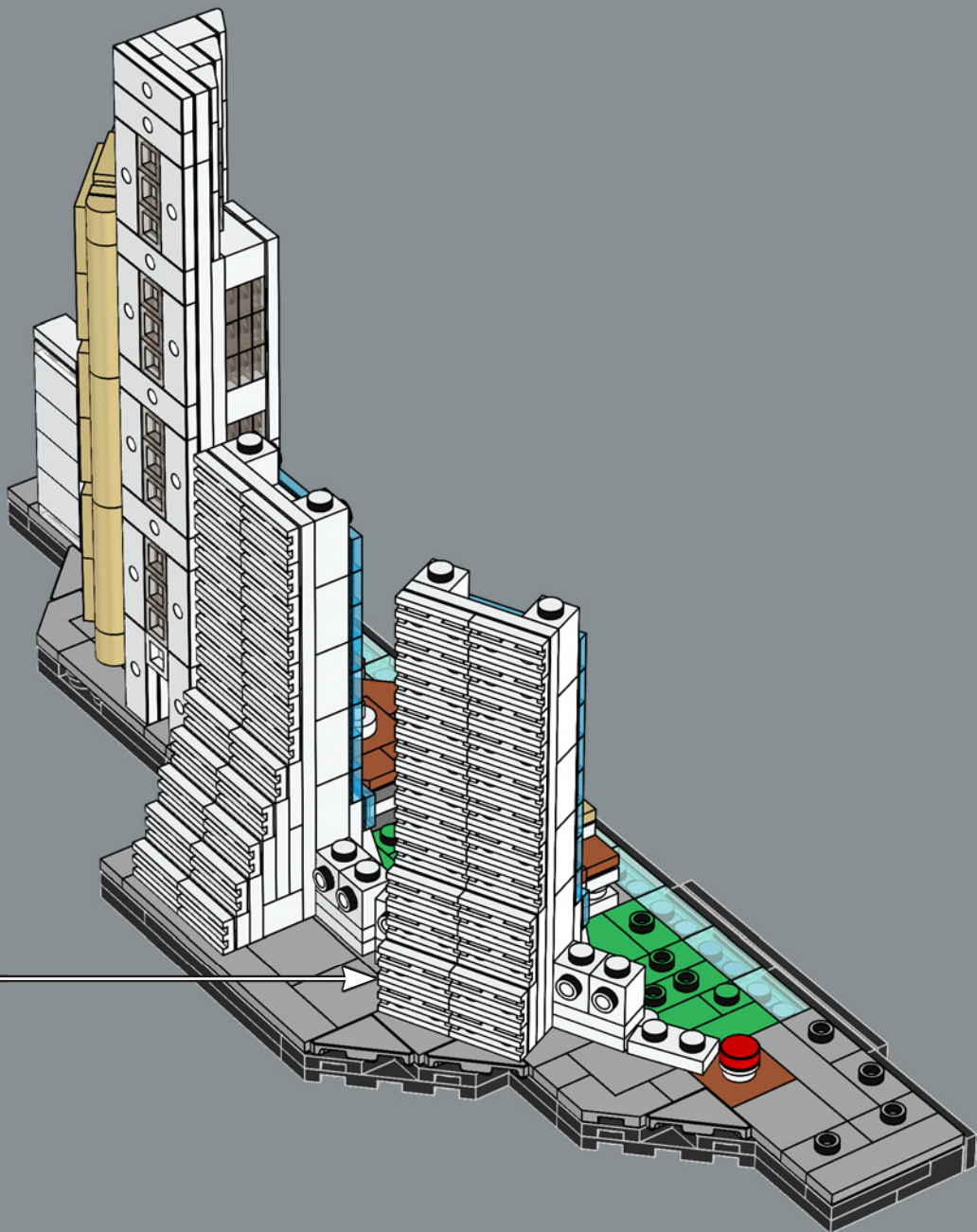

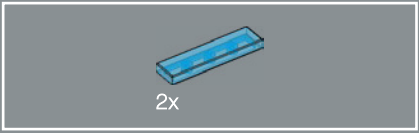

78

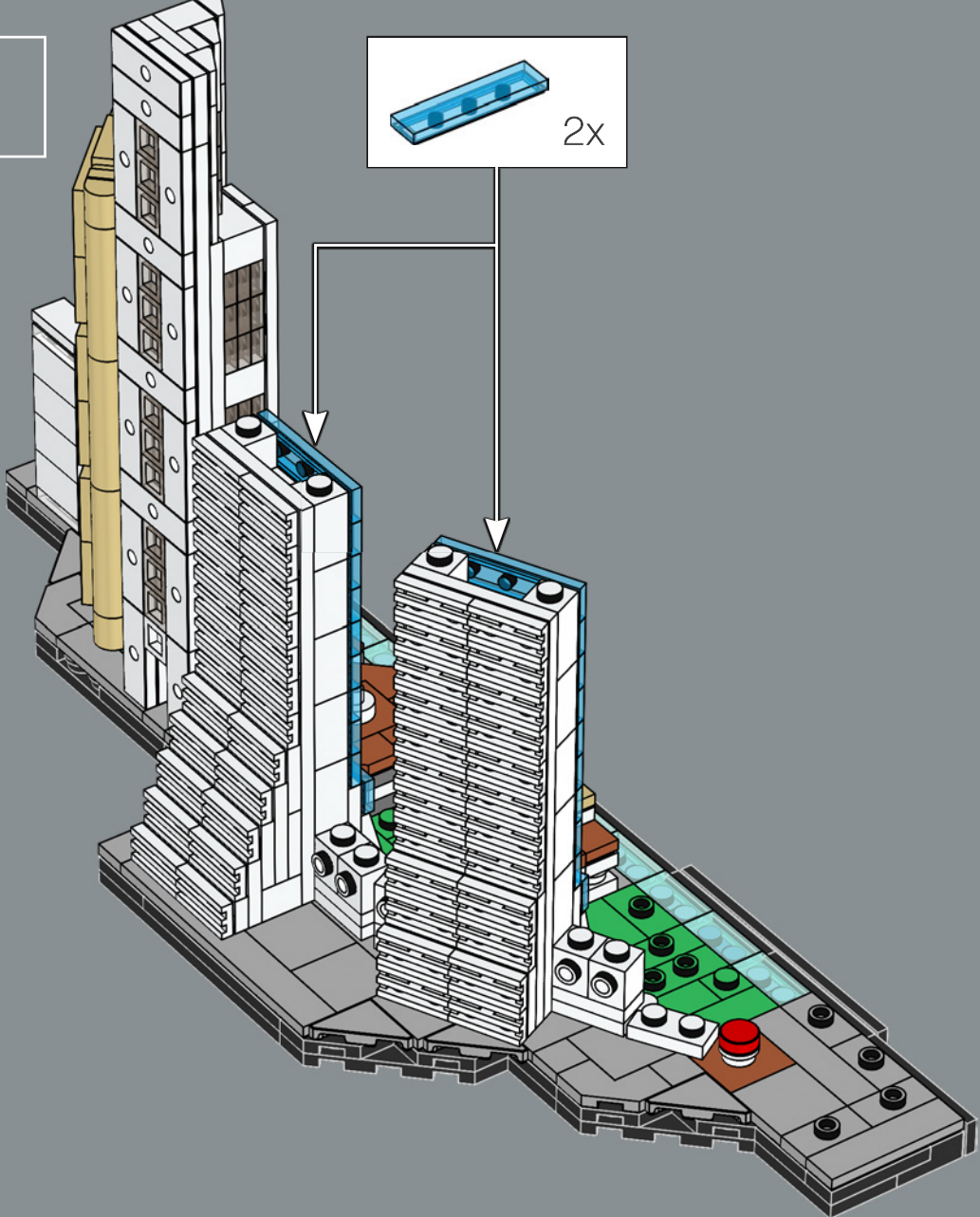
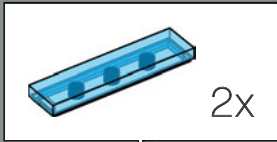

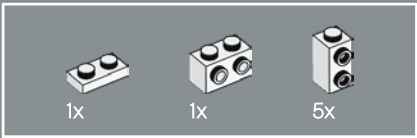

79

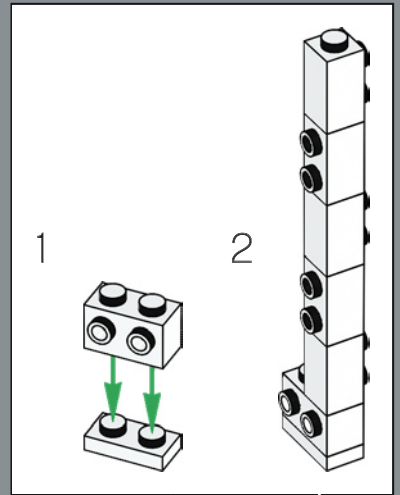
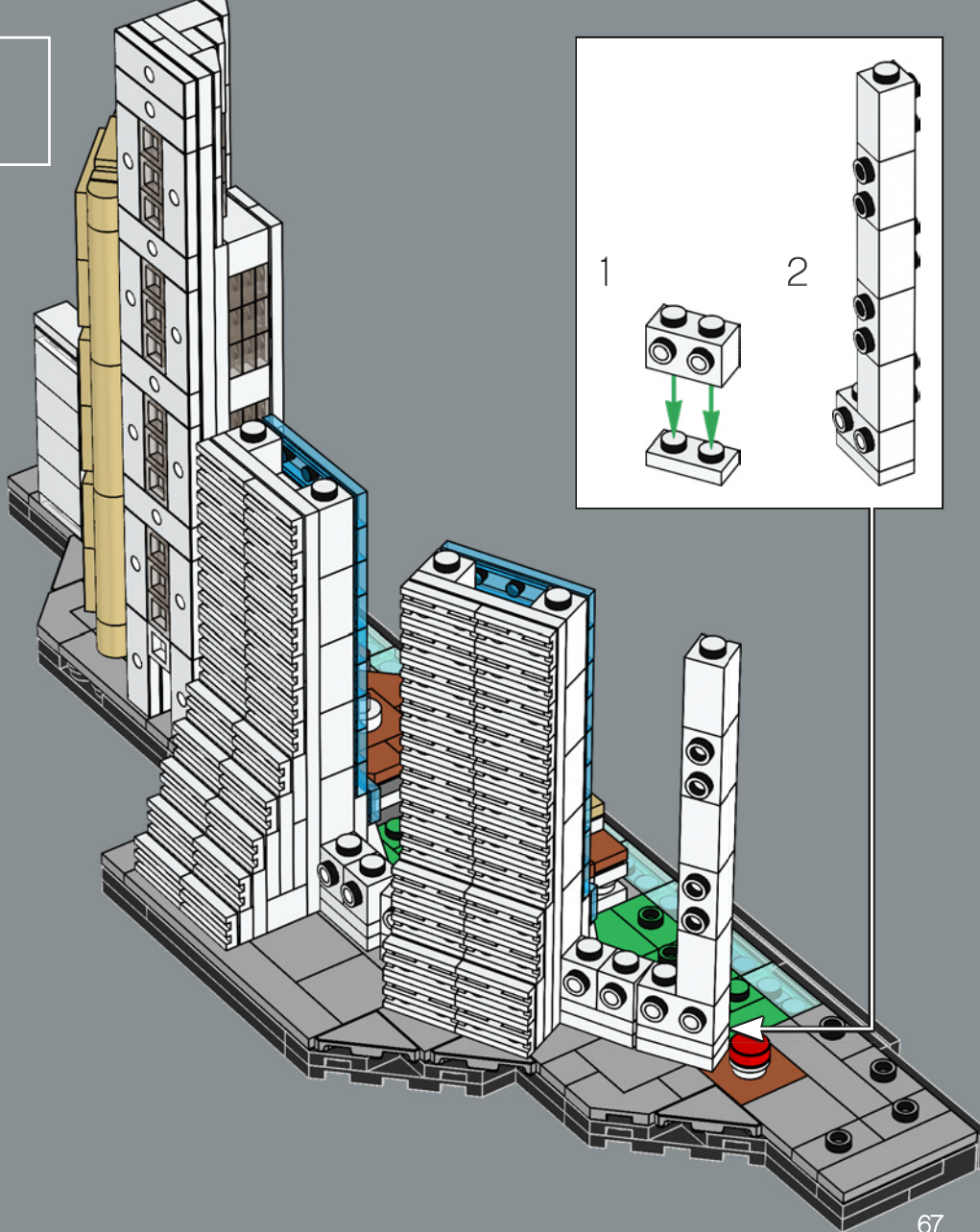

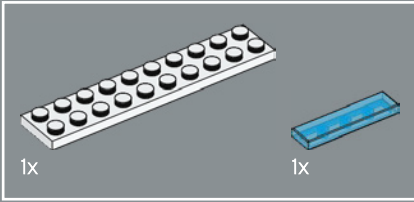
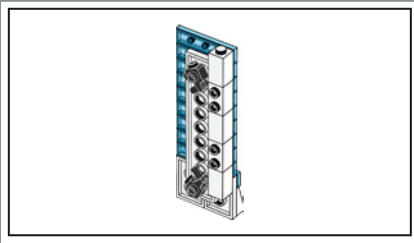

80

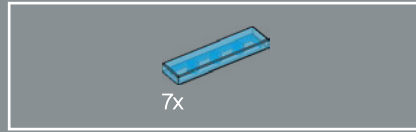
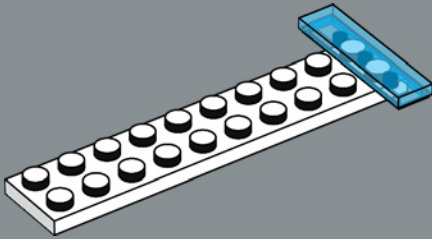

81

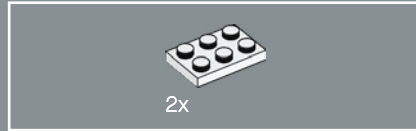
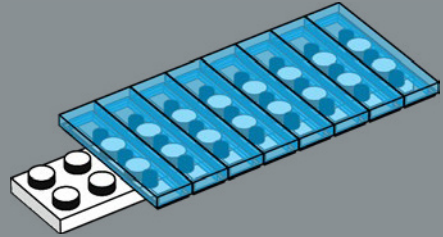

82

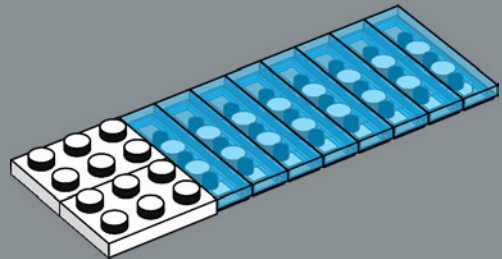

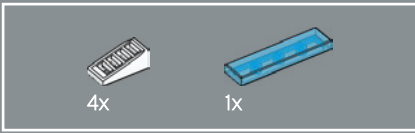

83

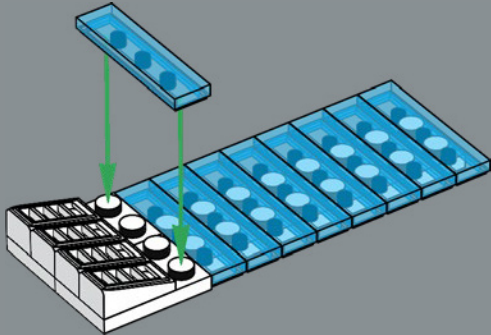

84

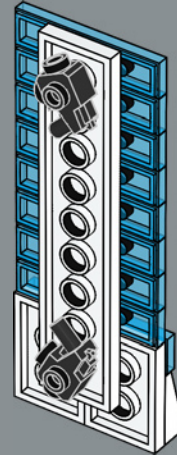

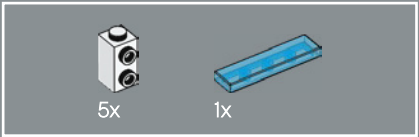

85

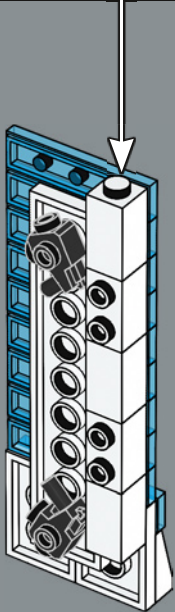
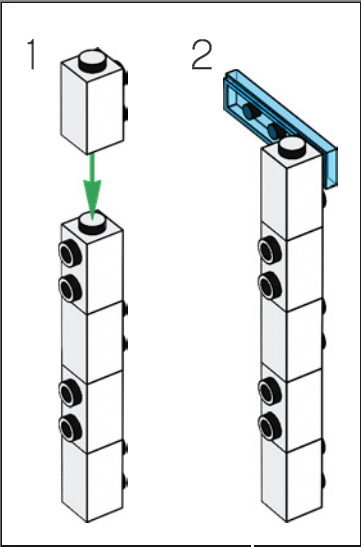

86

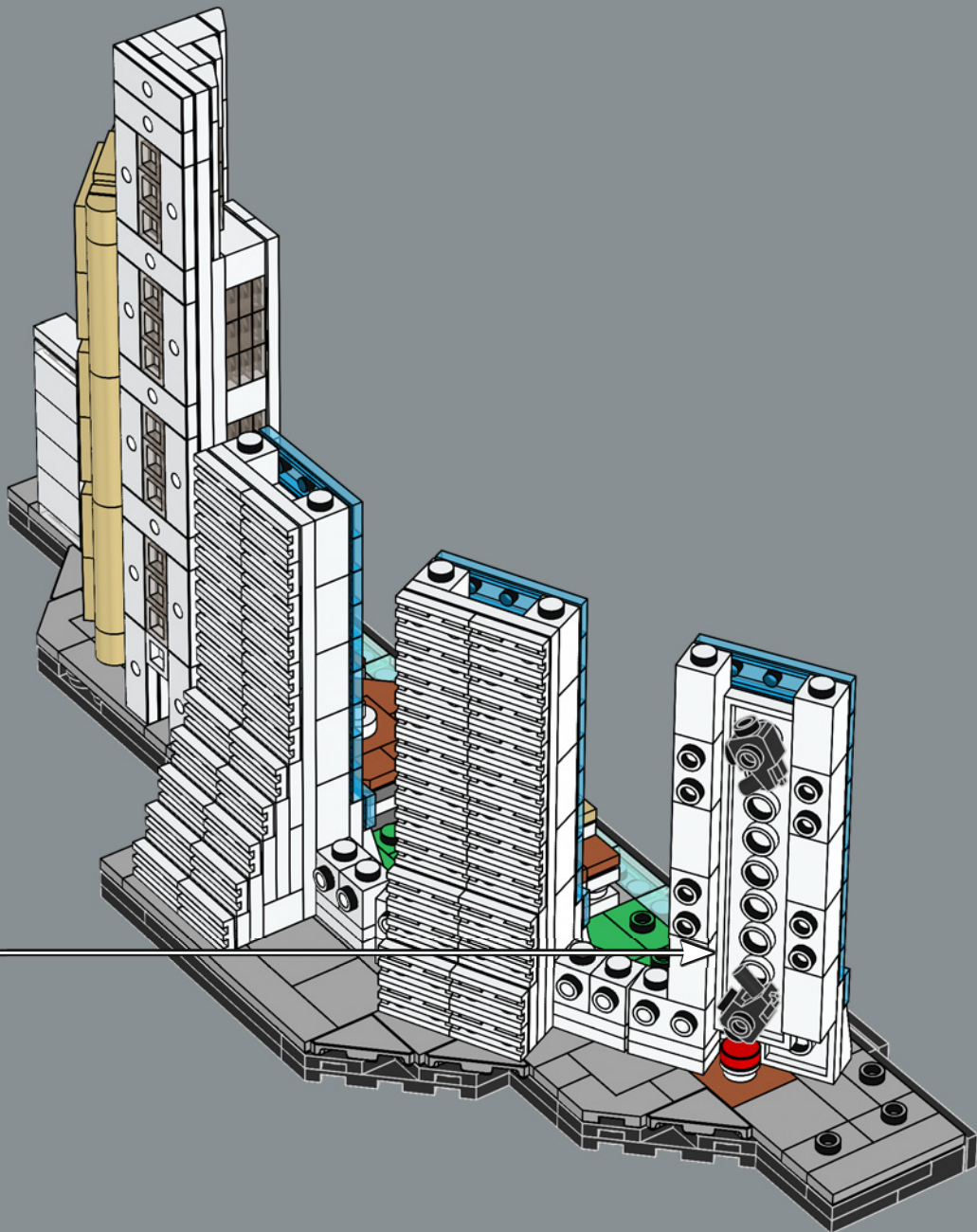

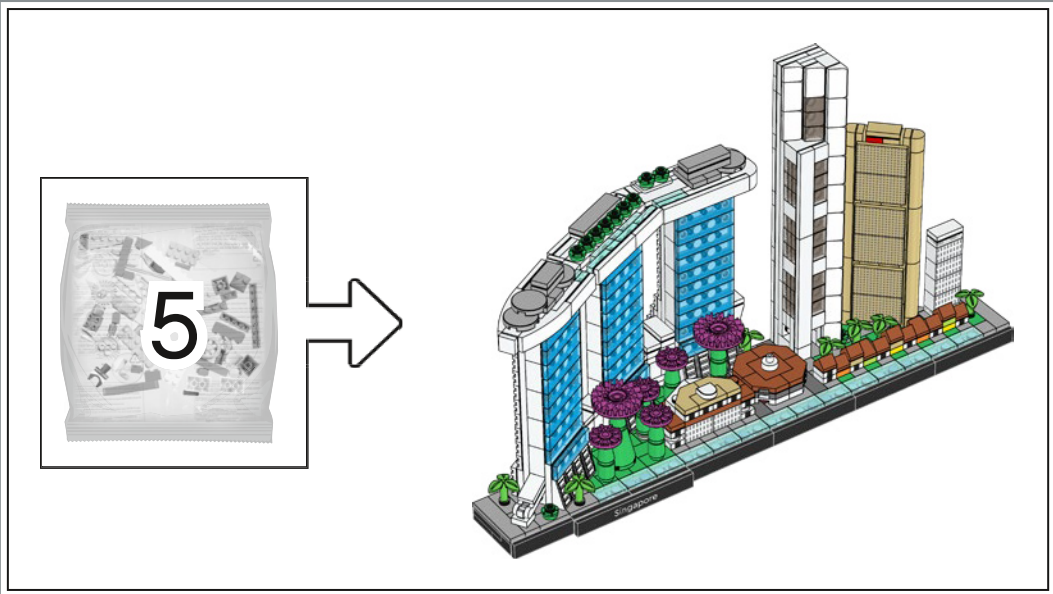



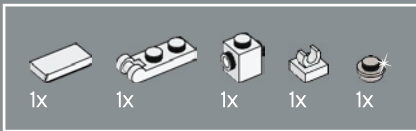

87

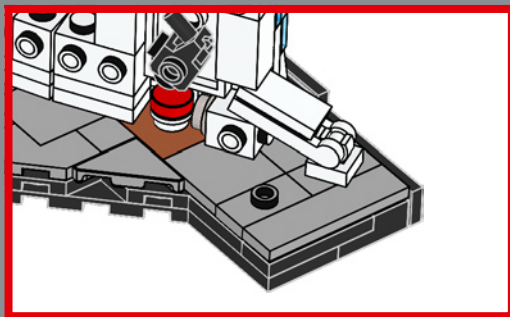
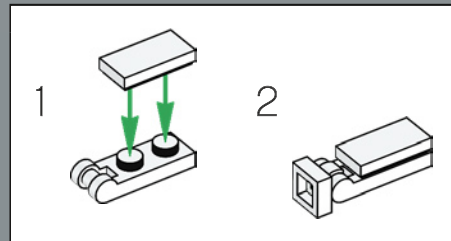
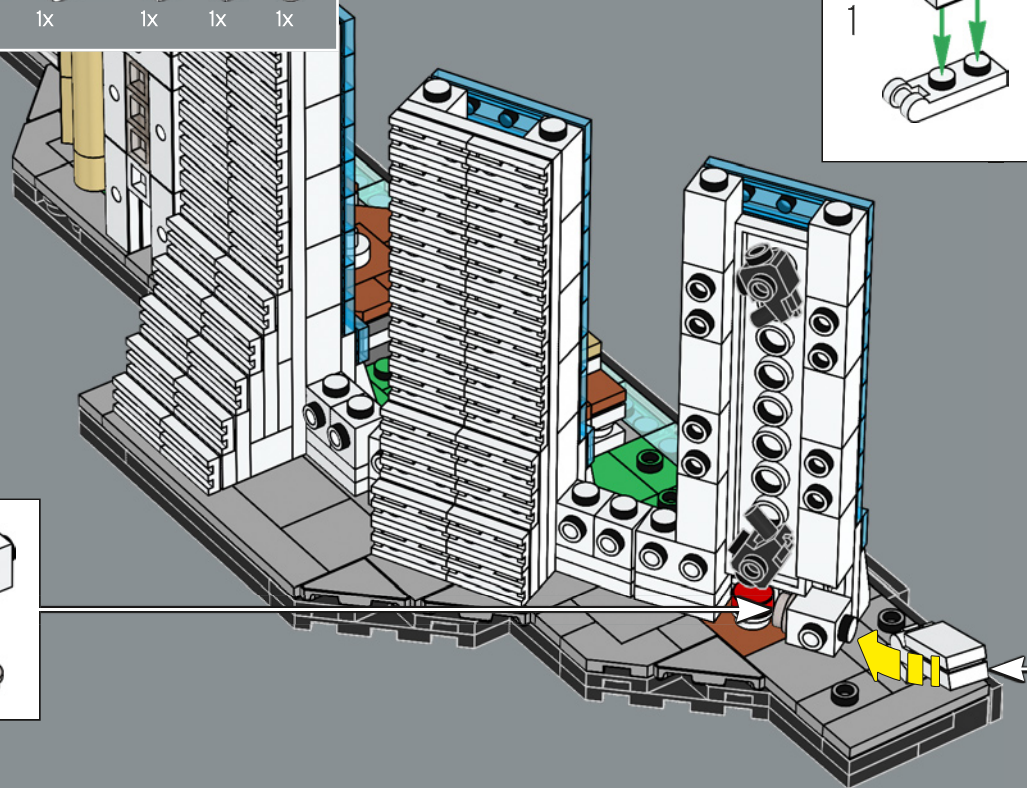
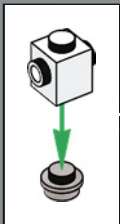

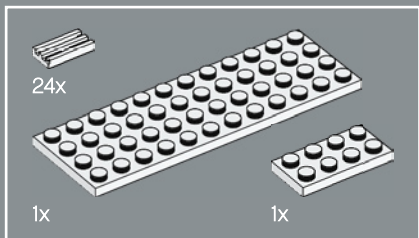

88

1

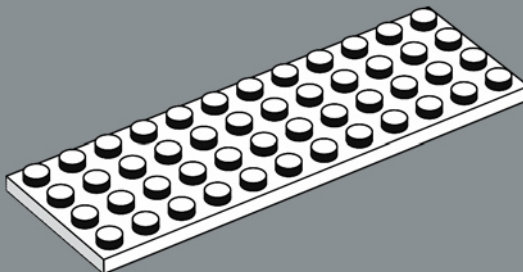

2

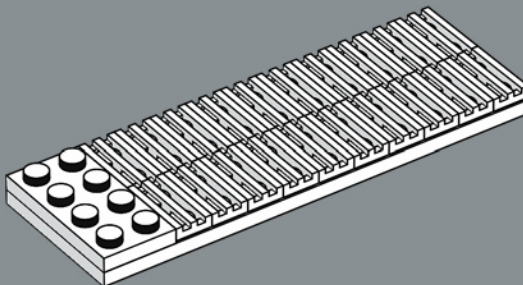

3

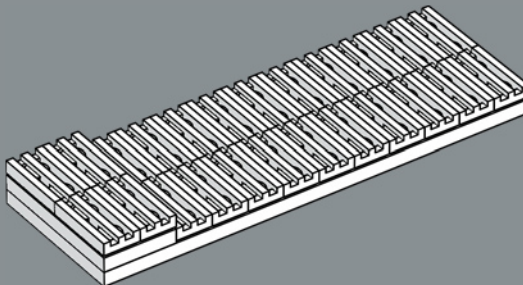



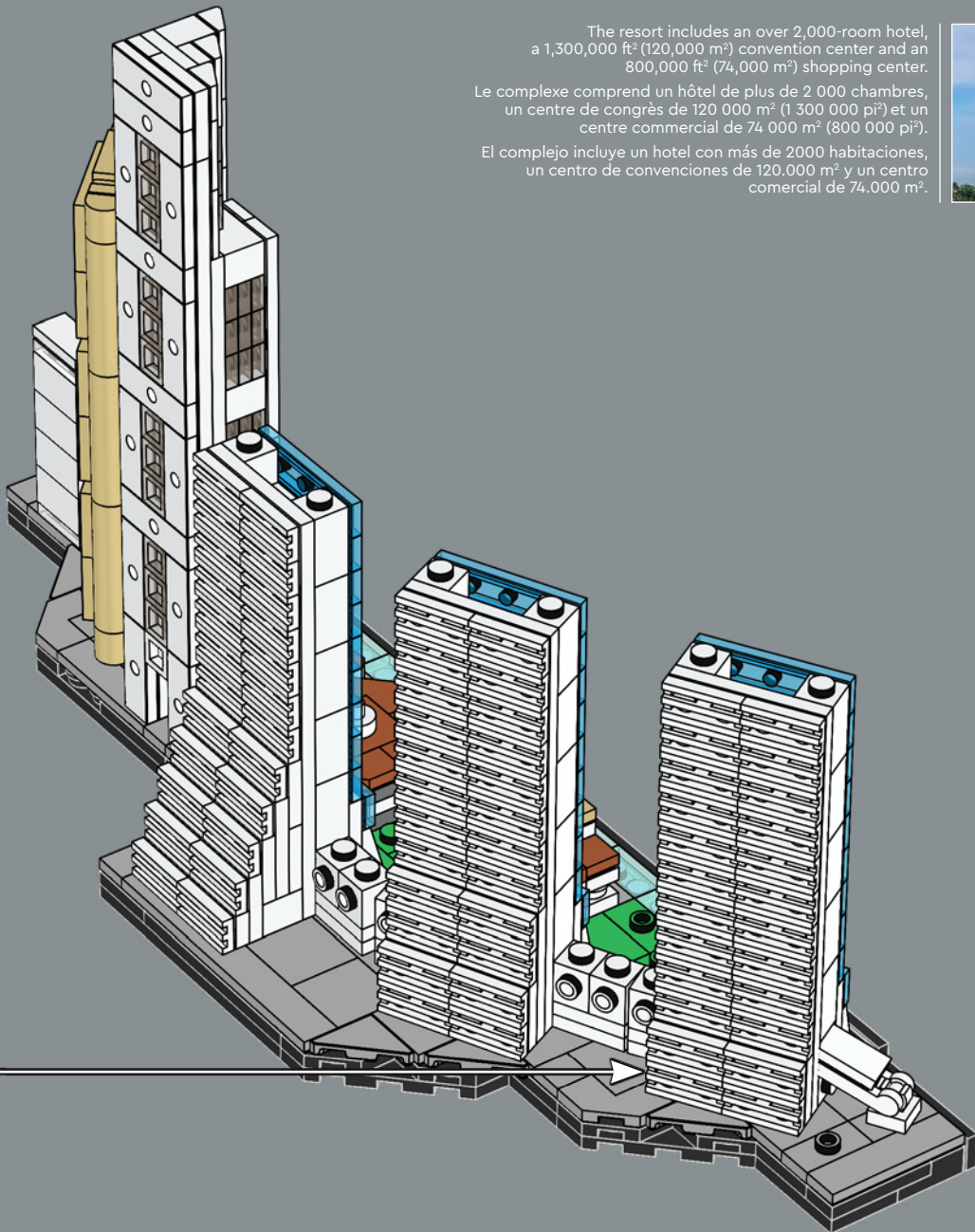

The resort includes an over 2,000-room hotel,  
a 1,300,000 ft<sup>2</sup> (120,000 m<sup>2</sup>) convention center and an  
800,000 ft<sup>2</sup> (74,000 m<sup>2</sup>) shopping center.

Le complexe comprend un hôtel de plus de 2 000 chambres,  
un centre de congrès de 120 000 m<sup>2</sup> (1 300 000 pi<sup>2</sup>) et un  
centre commercial de 74 000 m<sup>2</sup> (800 000 pi<sup>2</sup>).

El complejo incluye un hotel con más de 2000 habitaciones,  
un centro de convenciones de 120.000 m<sup>2</sup> y un centro  
comercial de 74.000 m<sup>2</sup>.



- 
 9x
- 
 2x
- 
 1x
- 
 2x

89

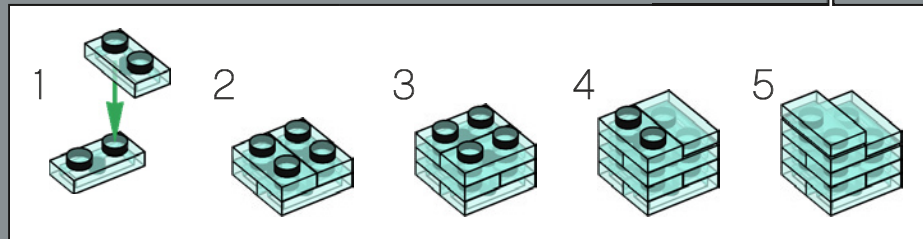
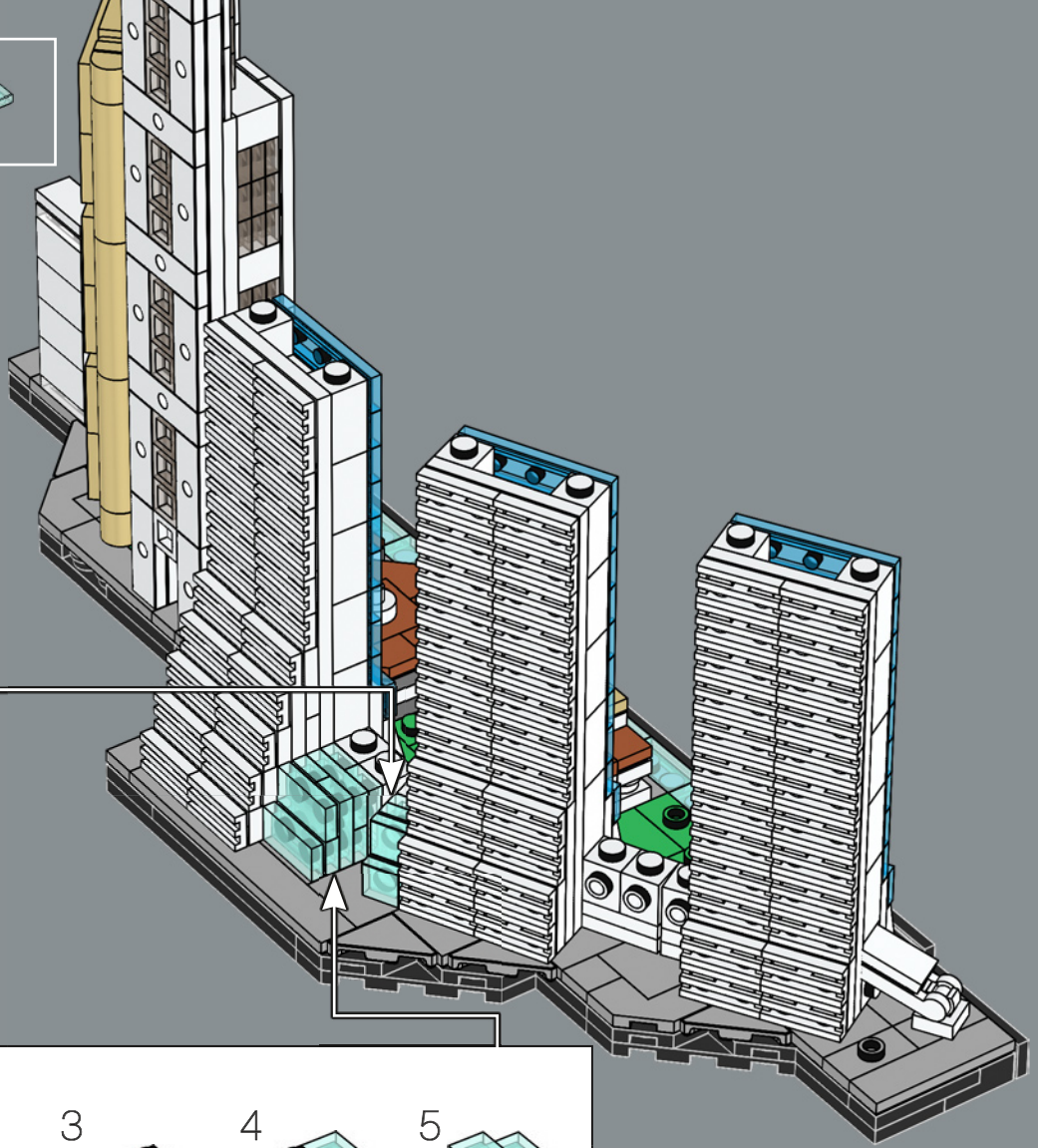
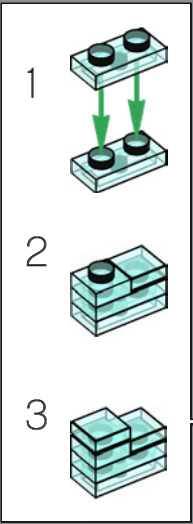

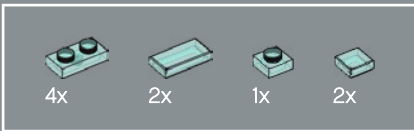

90

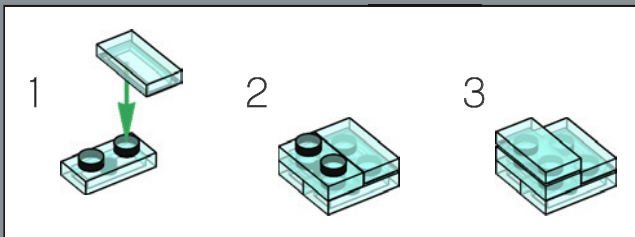
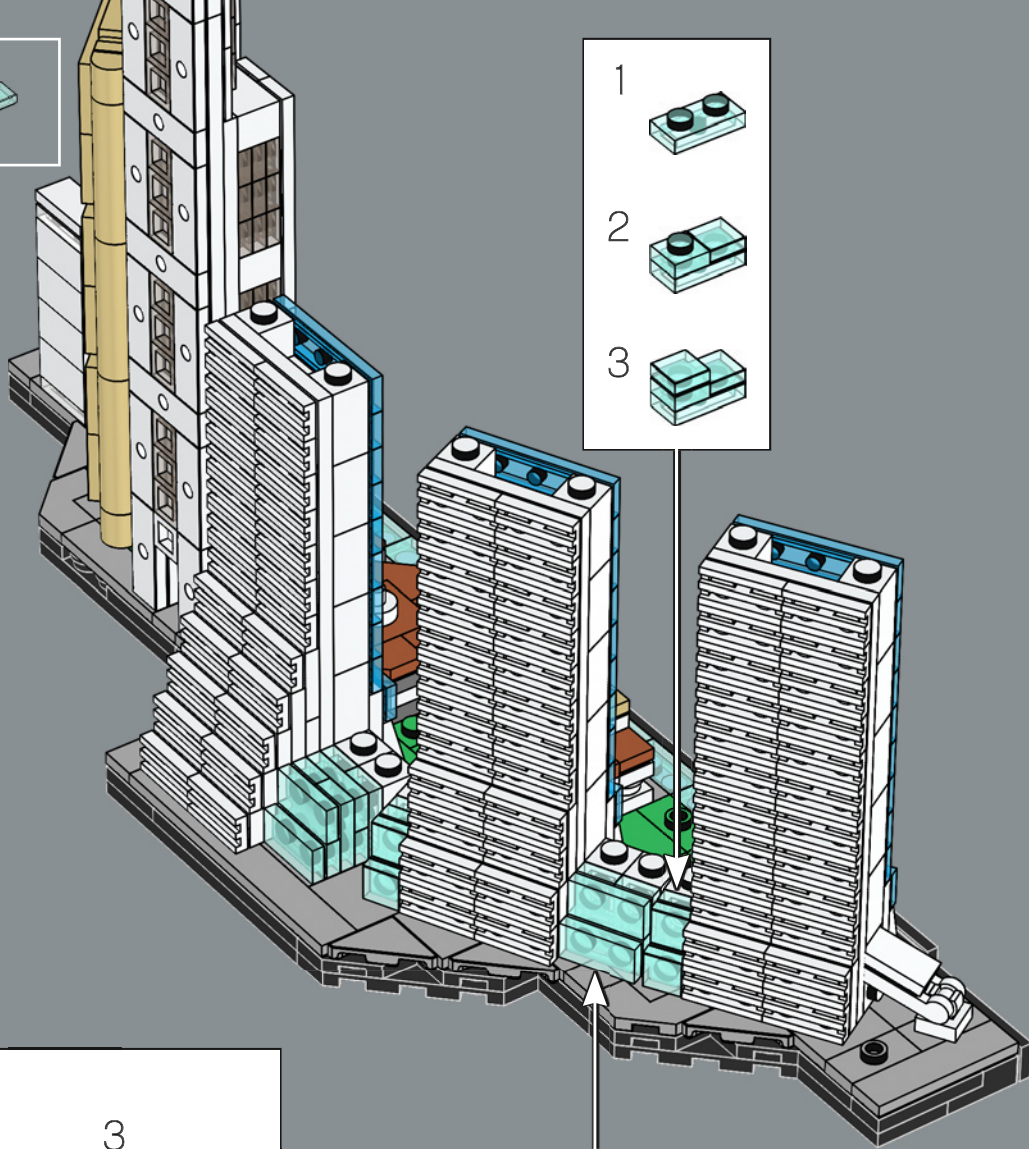
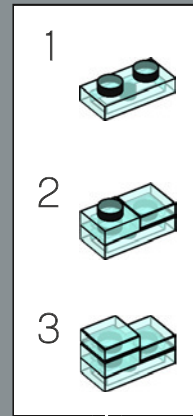

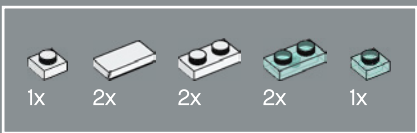

91

1

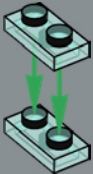

2

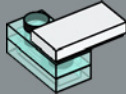

3

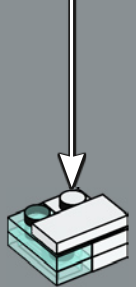
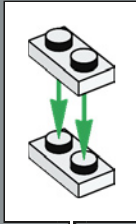



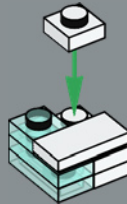

4

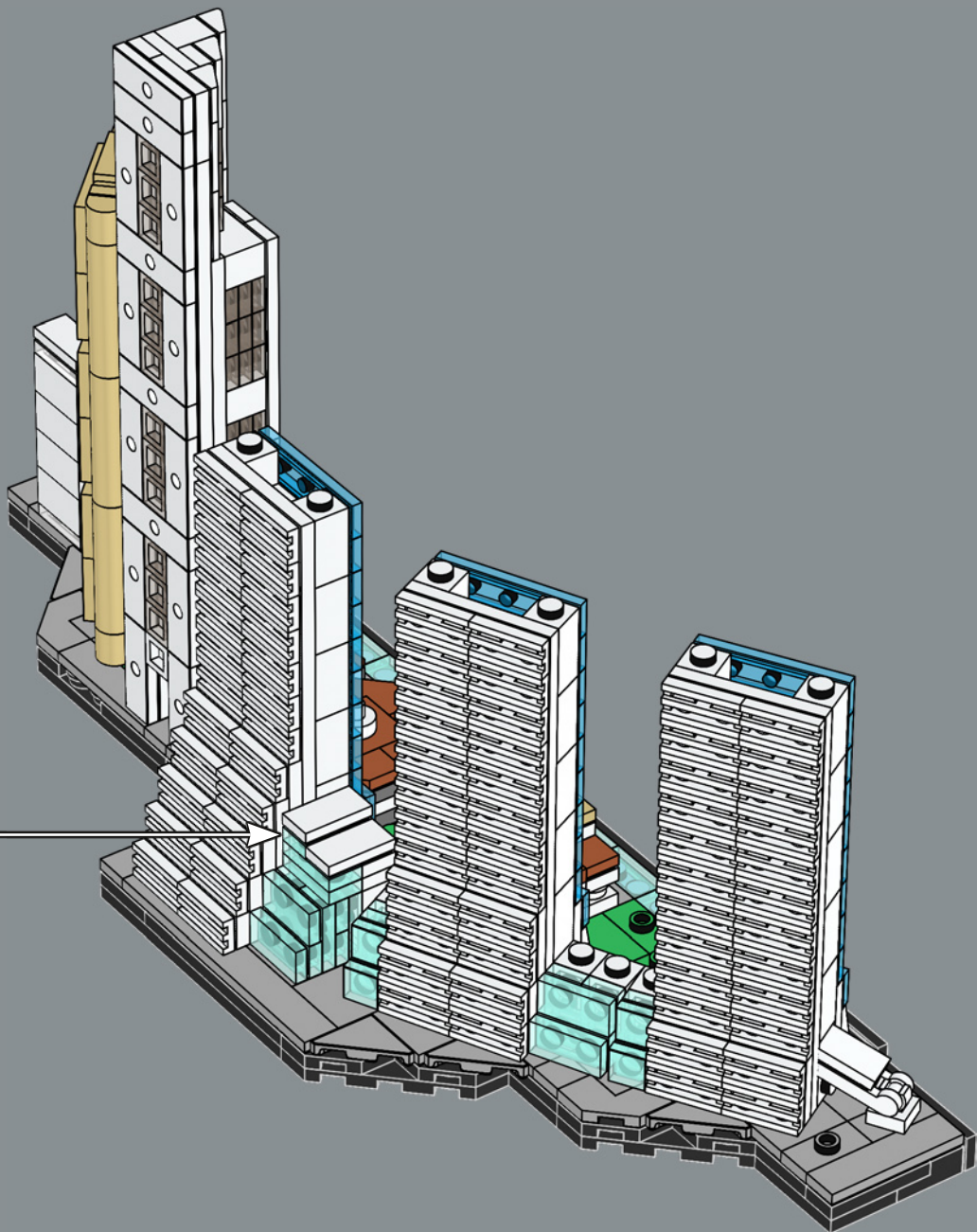

5





-   
1x
-   
2x
-   
1x
-   
3x

92

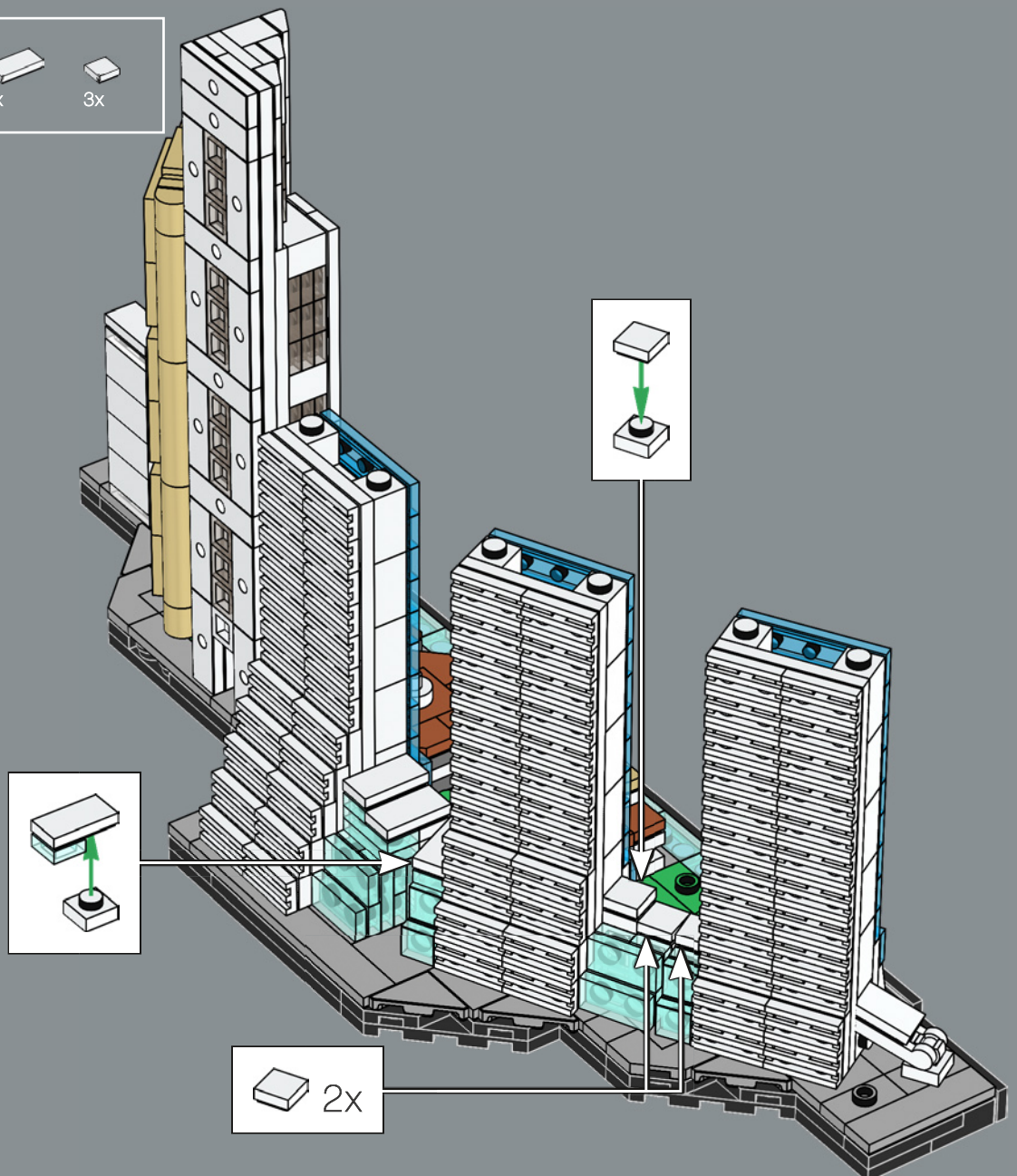





93



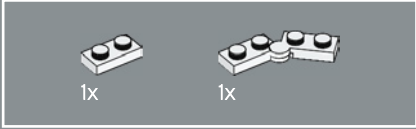
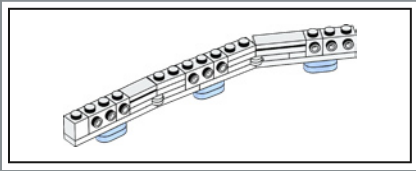

94

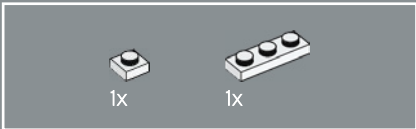
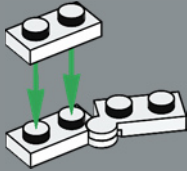

95

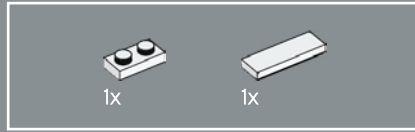
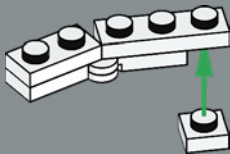

96

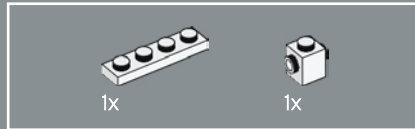
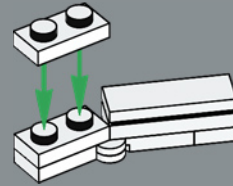

97

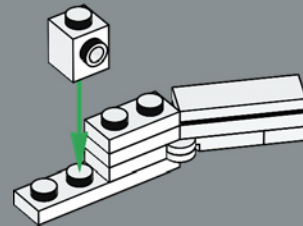

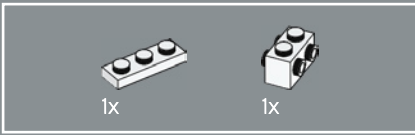

98

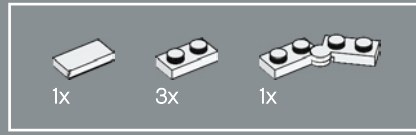
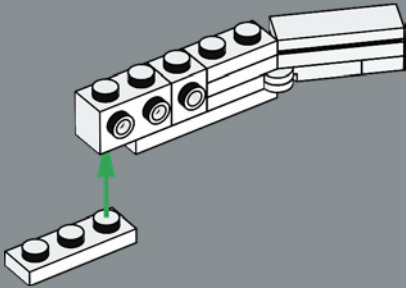

99

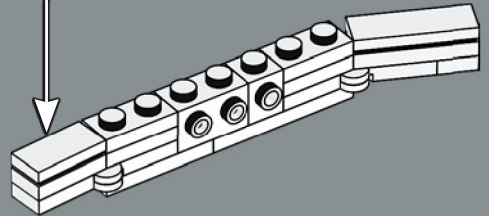
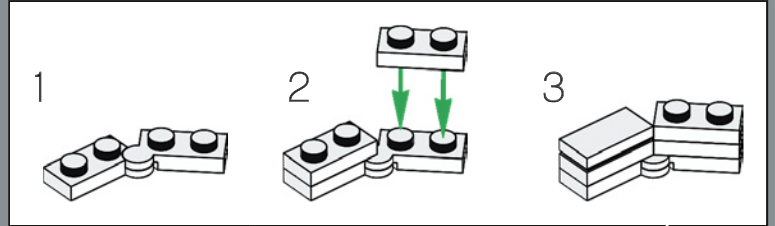

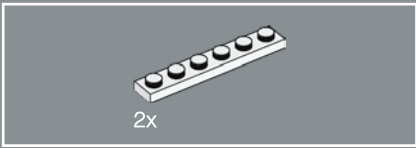

100

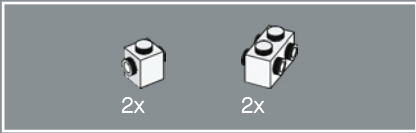
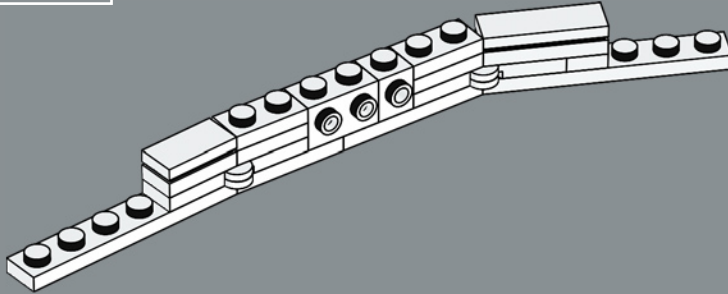

101

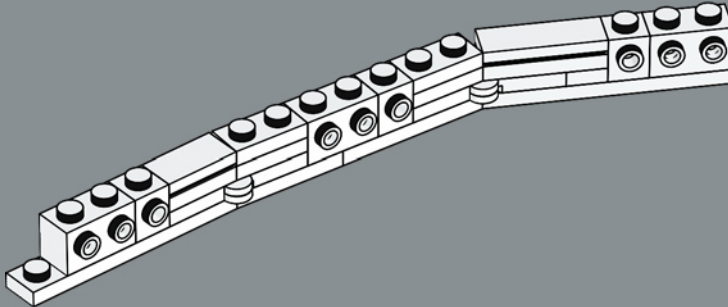

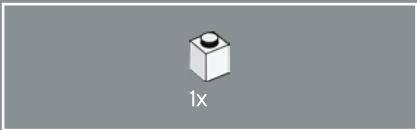

102

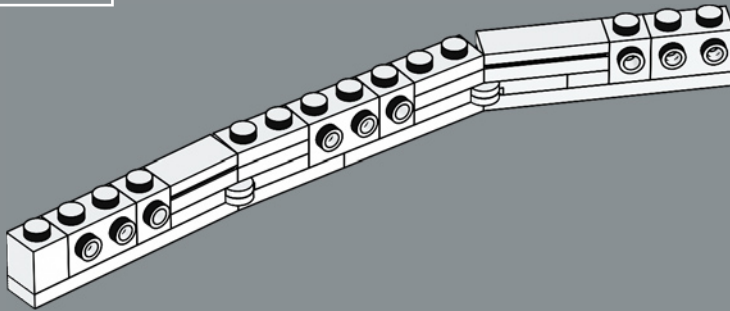

103

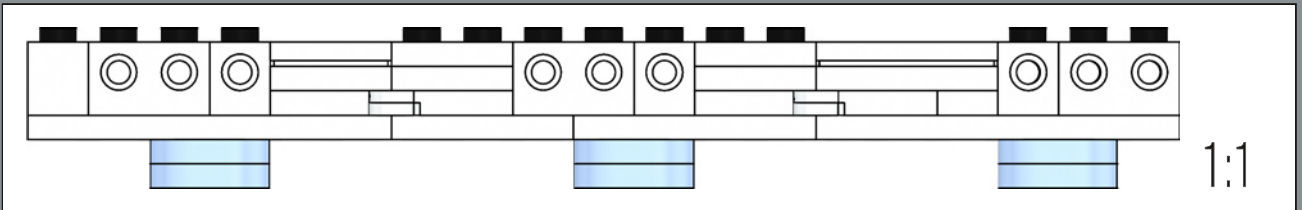
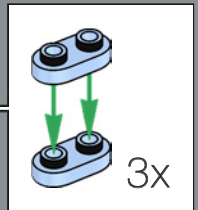
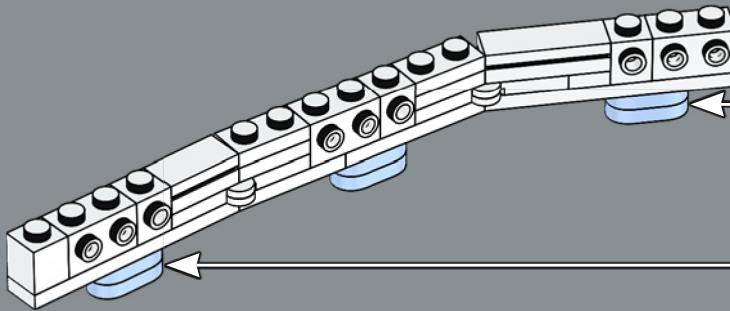

104



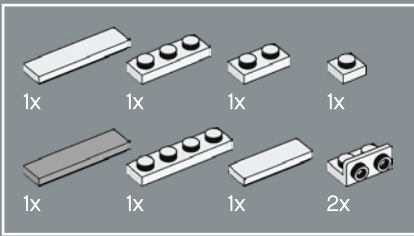

105

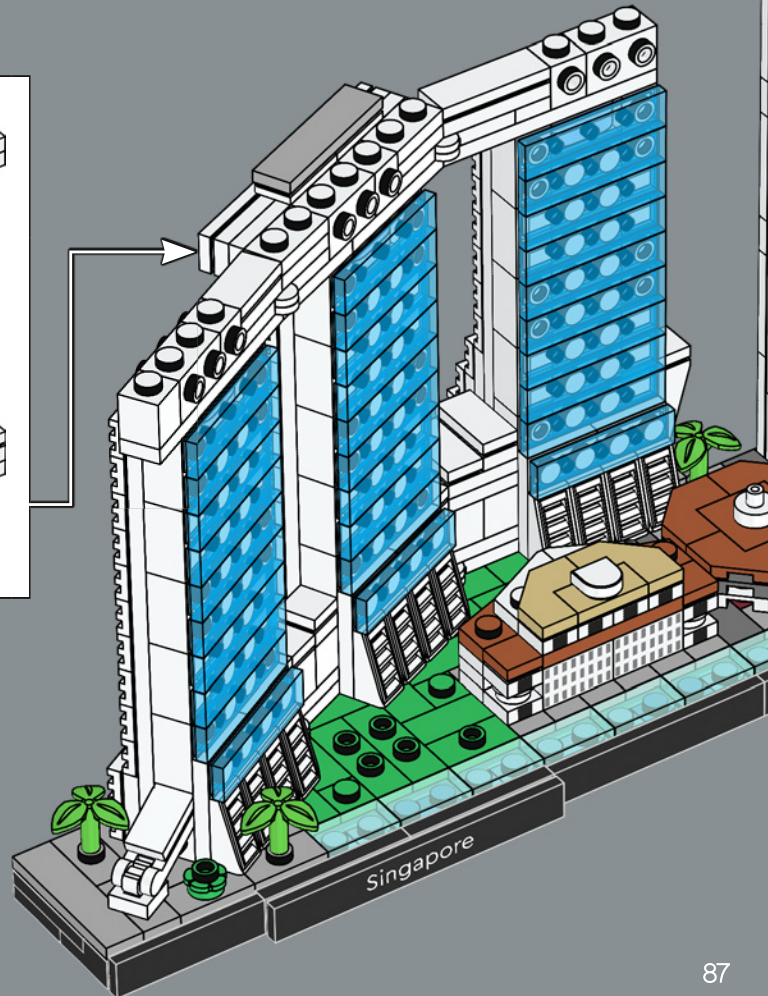
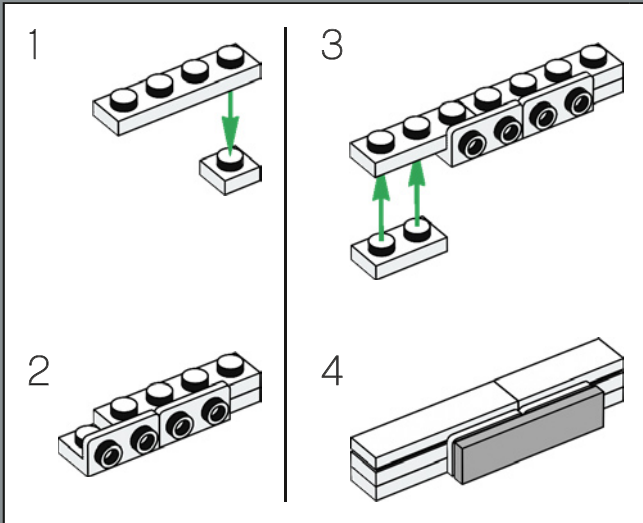





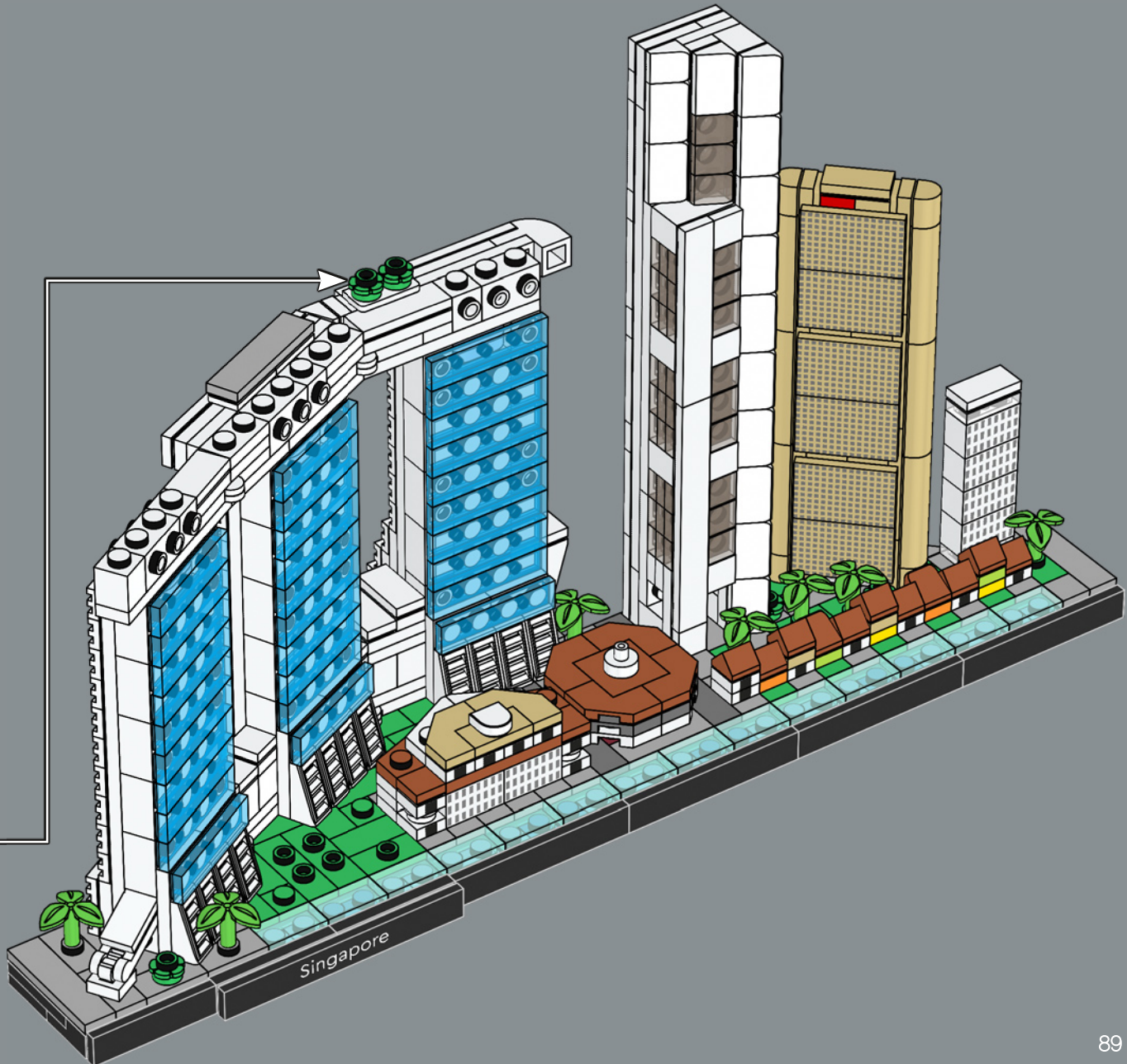

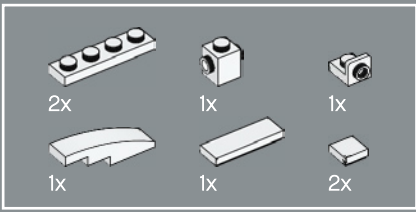

107

1

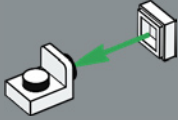

2

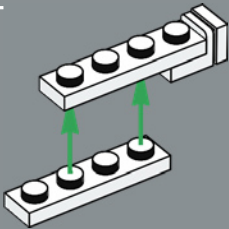

3

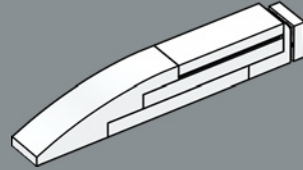

4

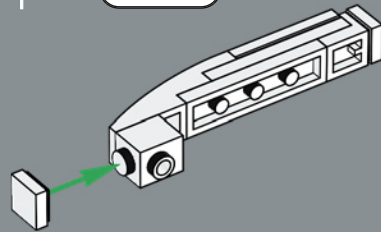



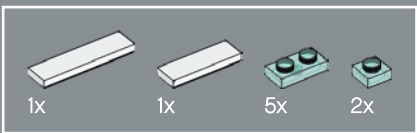

108

1

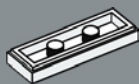

2

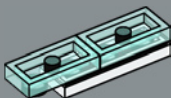

3

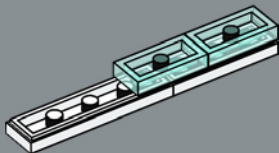

4

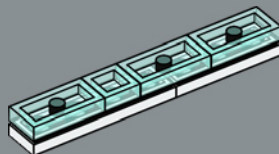

5

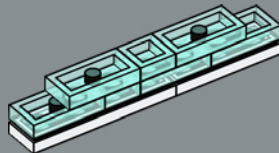

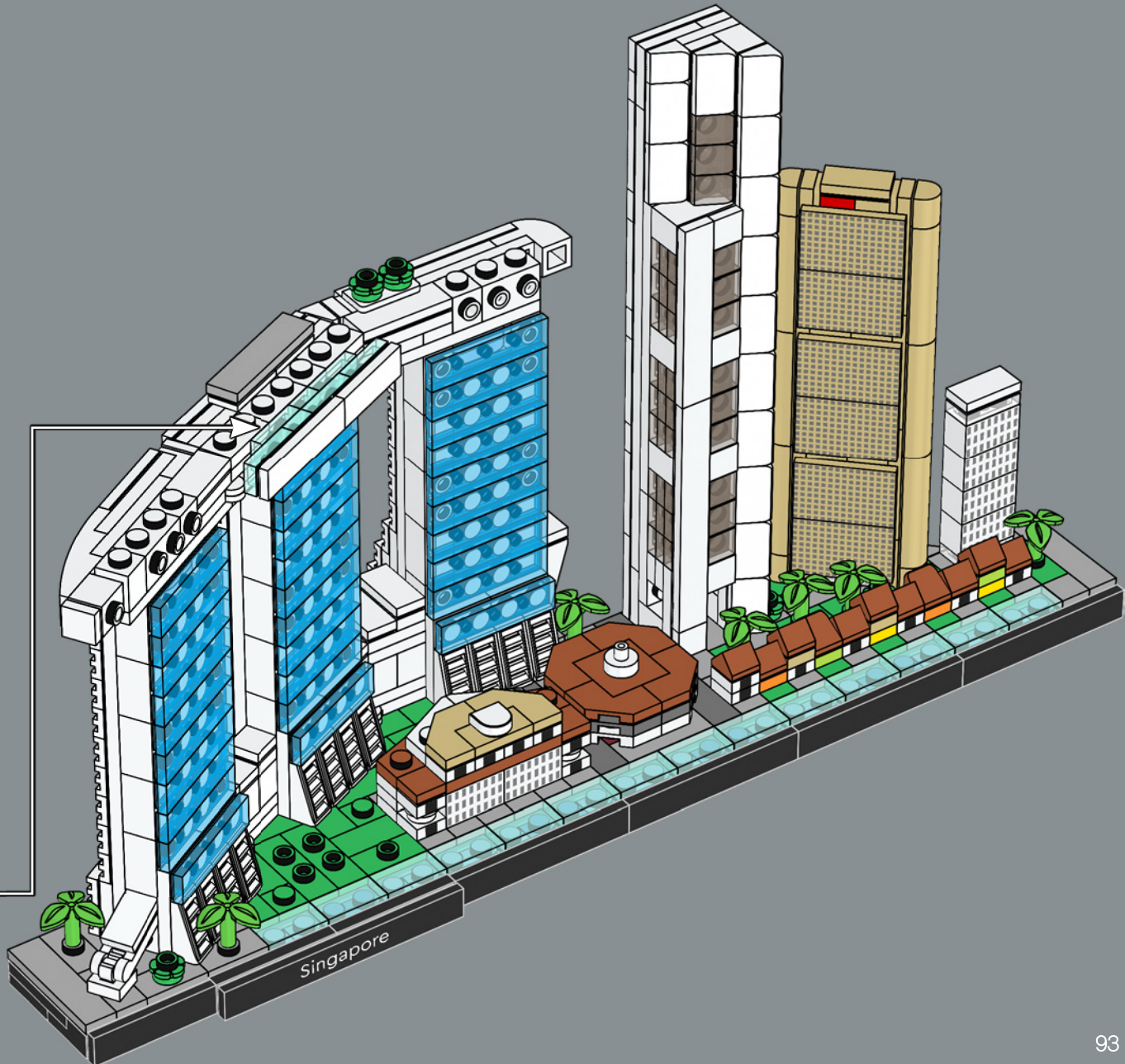

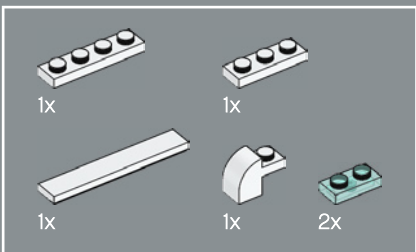

109

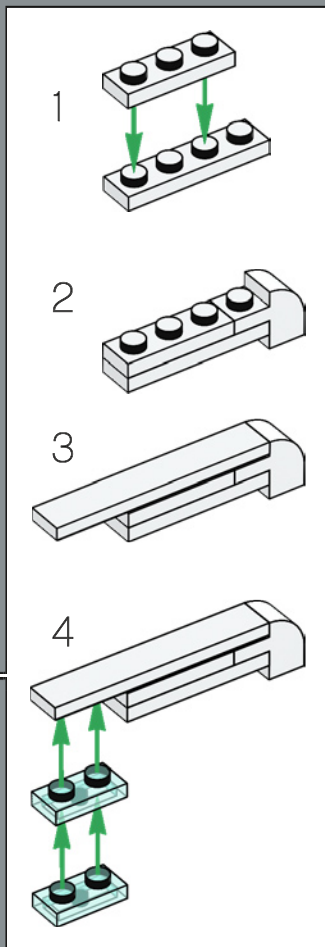
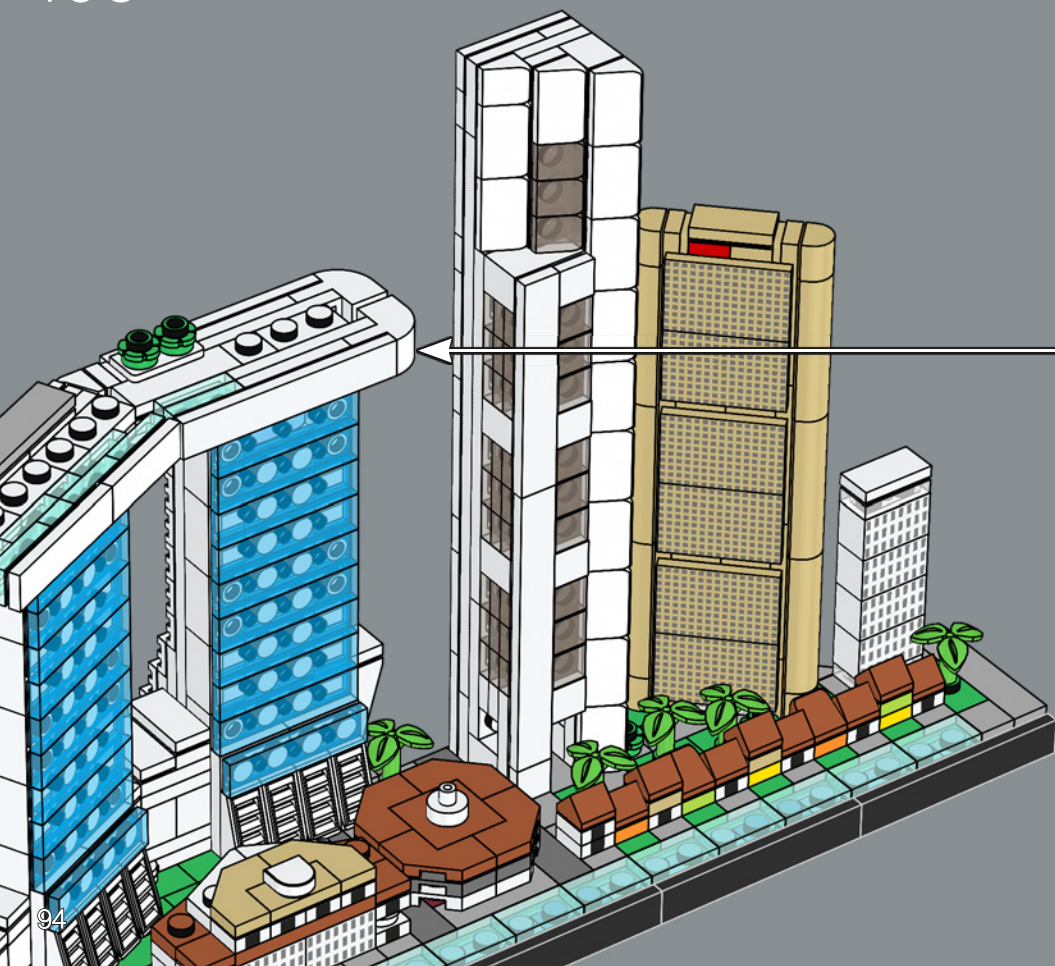

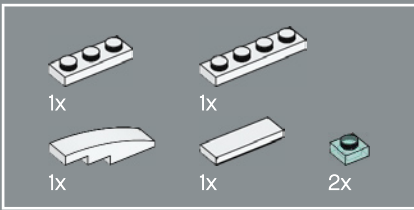





The cantilevered platform overhangs the north tower by 220 ft. (67 m).

La plate-forme en porte-à-faux surplombe la tour nord de 67 m (220 pi).

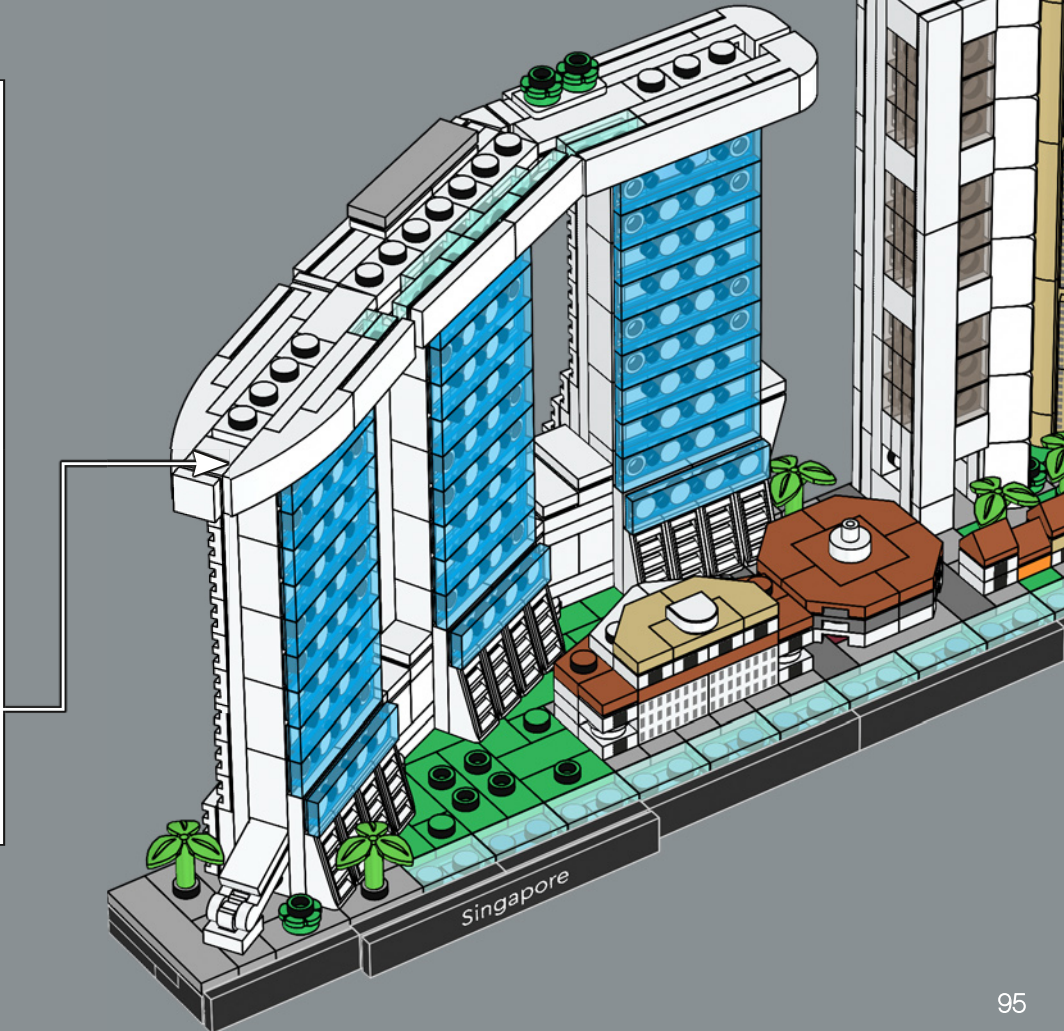
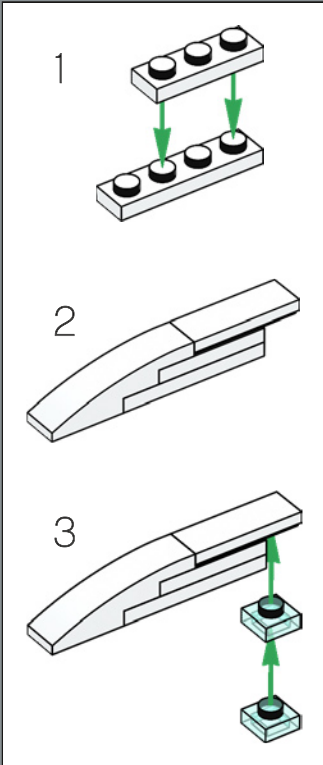
El voladizo que sobresale de la torre norte mide 67 m.

110



		
3x	4x	7x

111





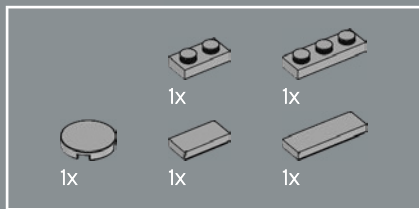

112

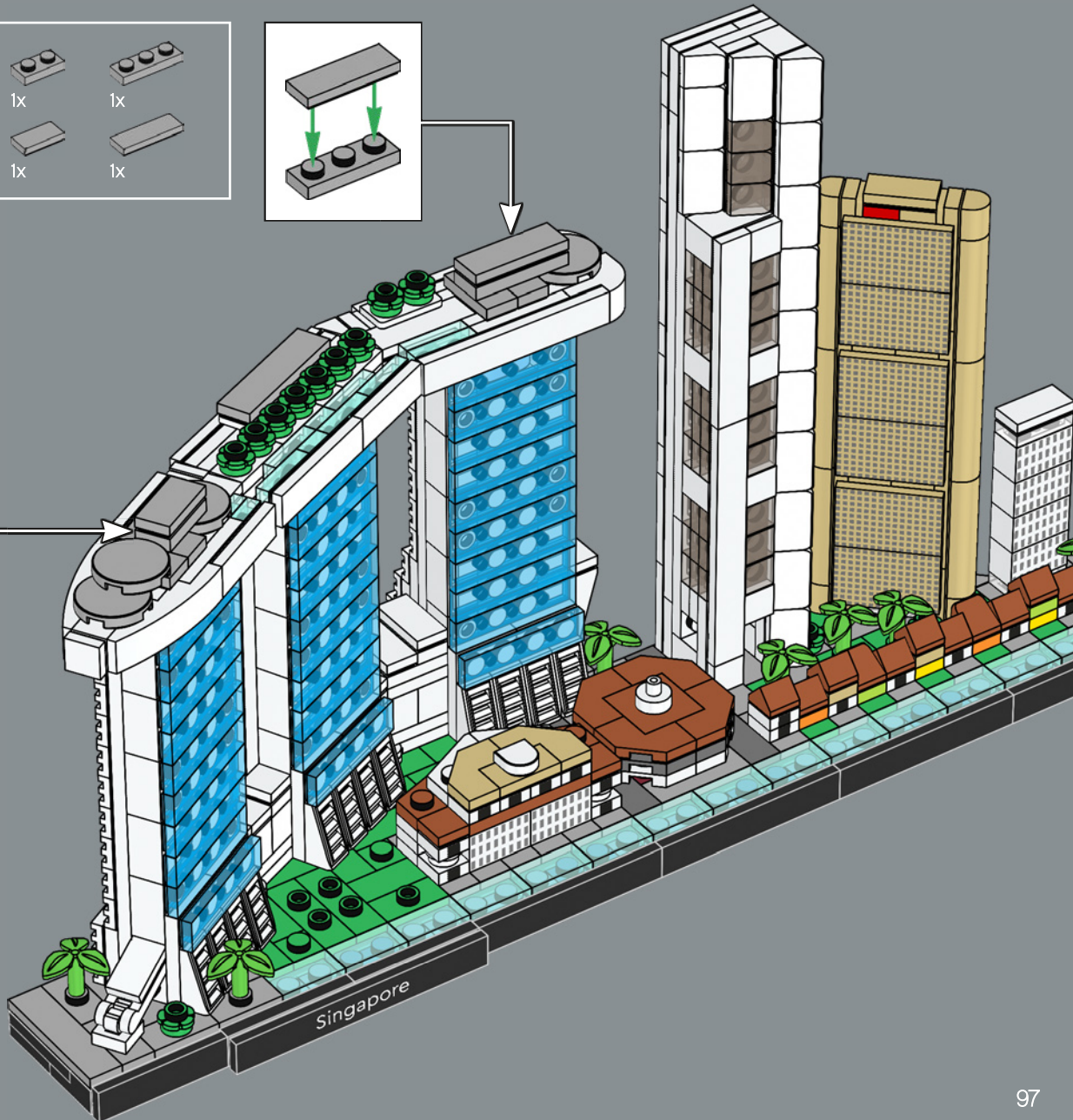
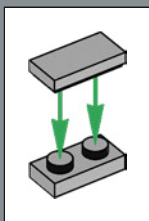
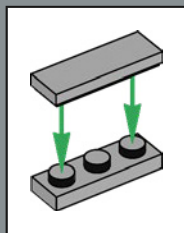



113

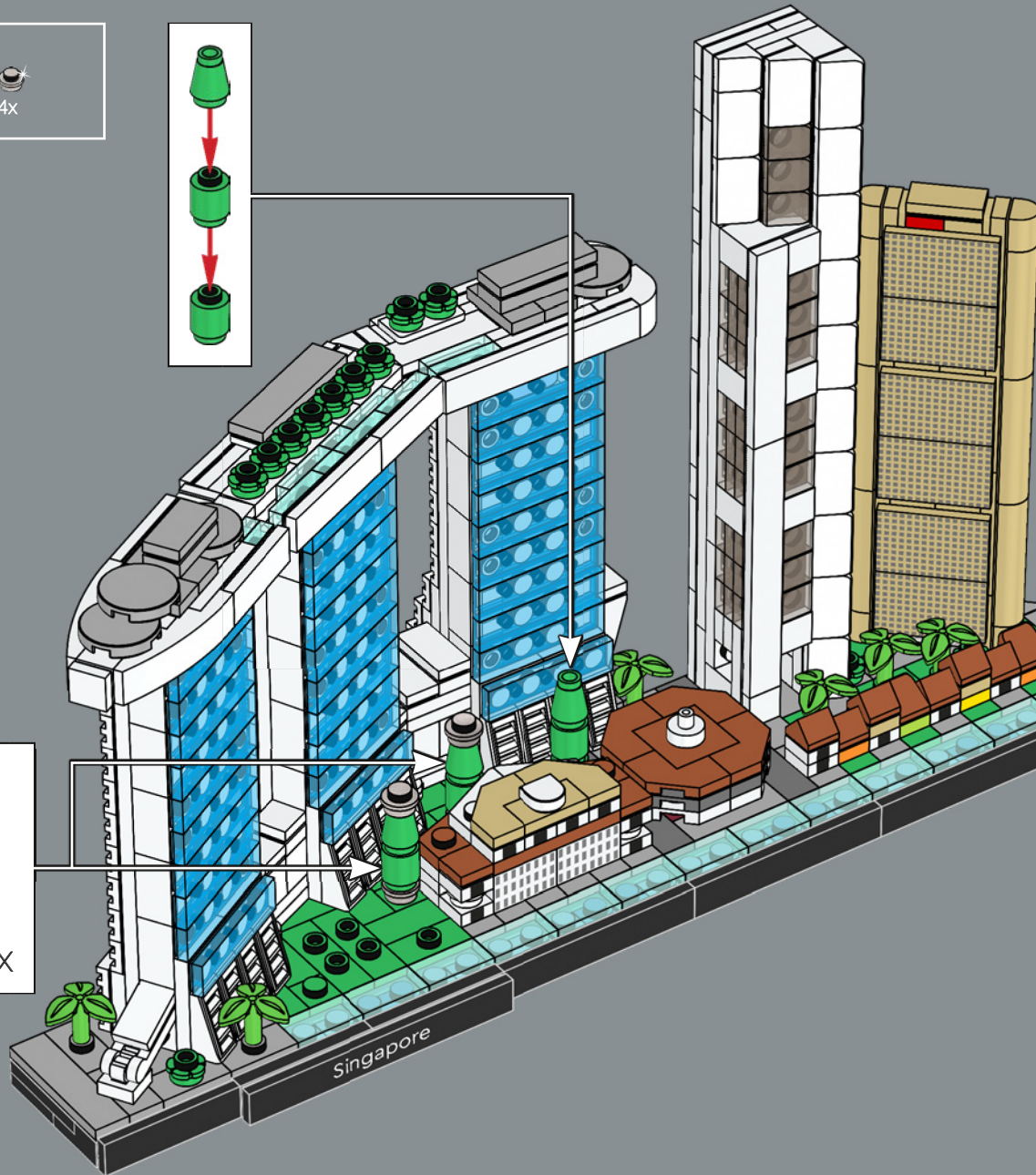
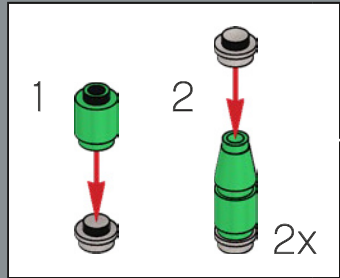
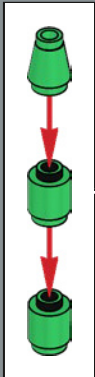

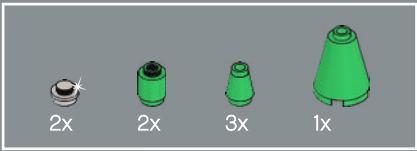

114

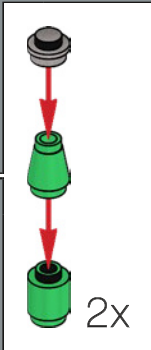
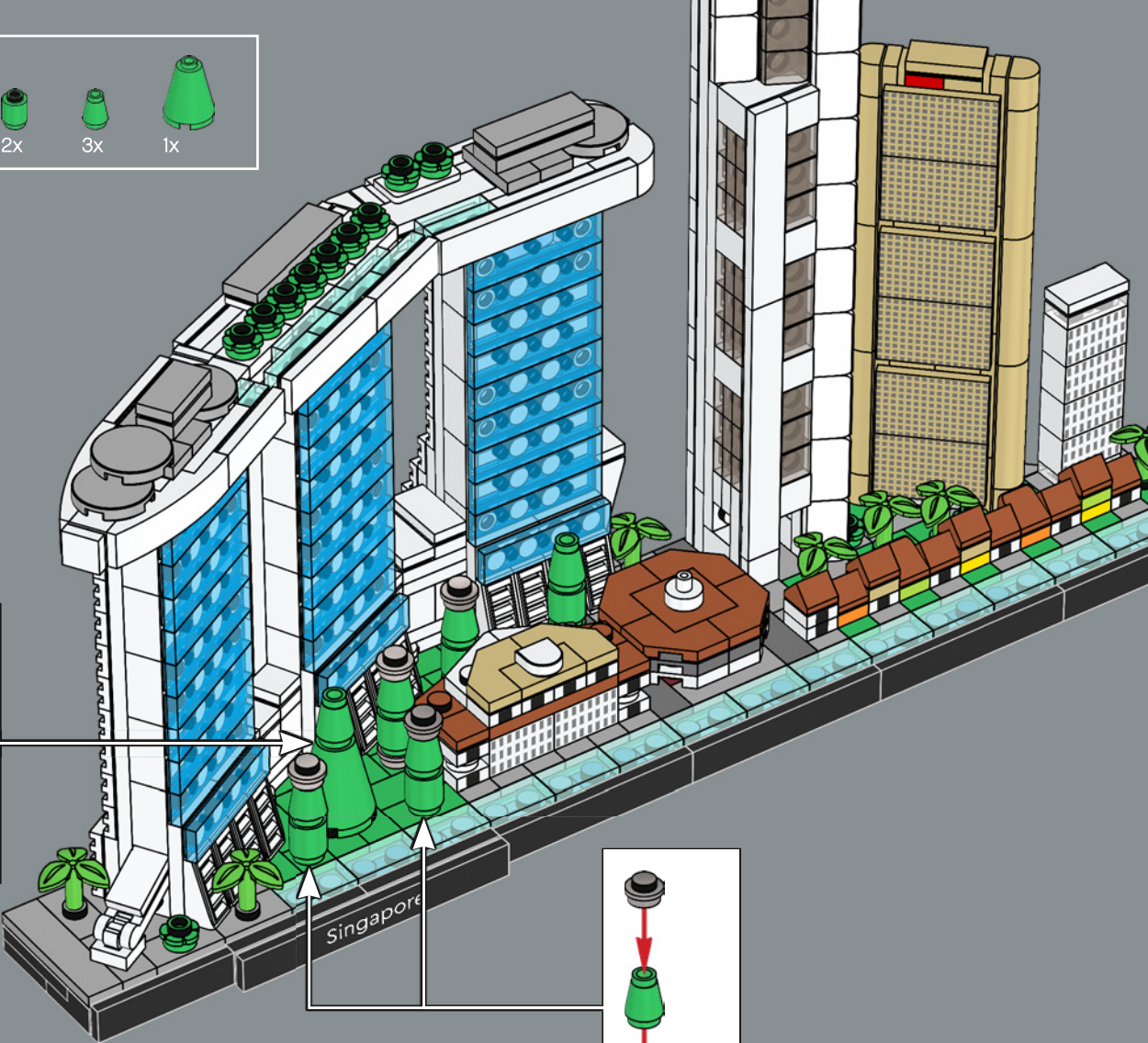
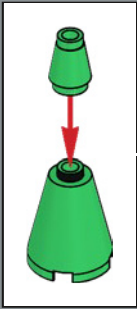



115

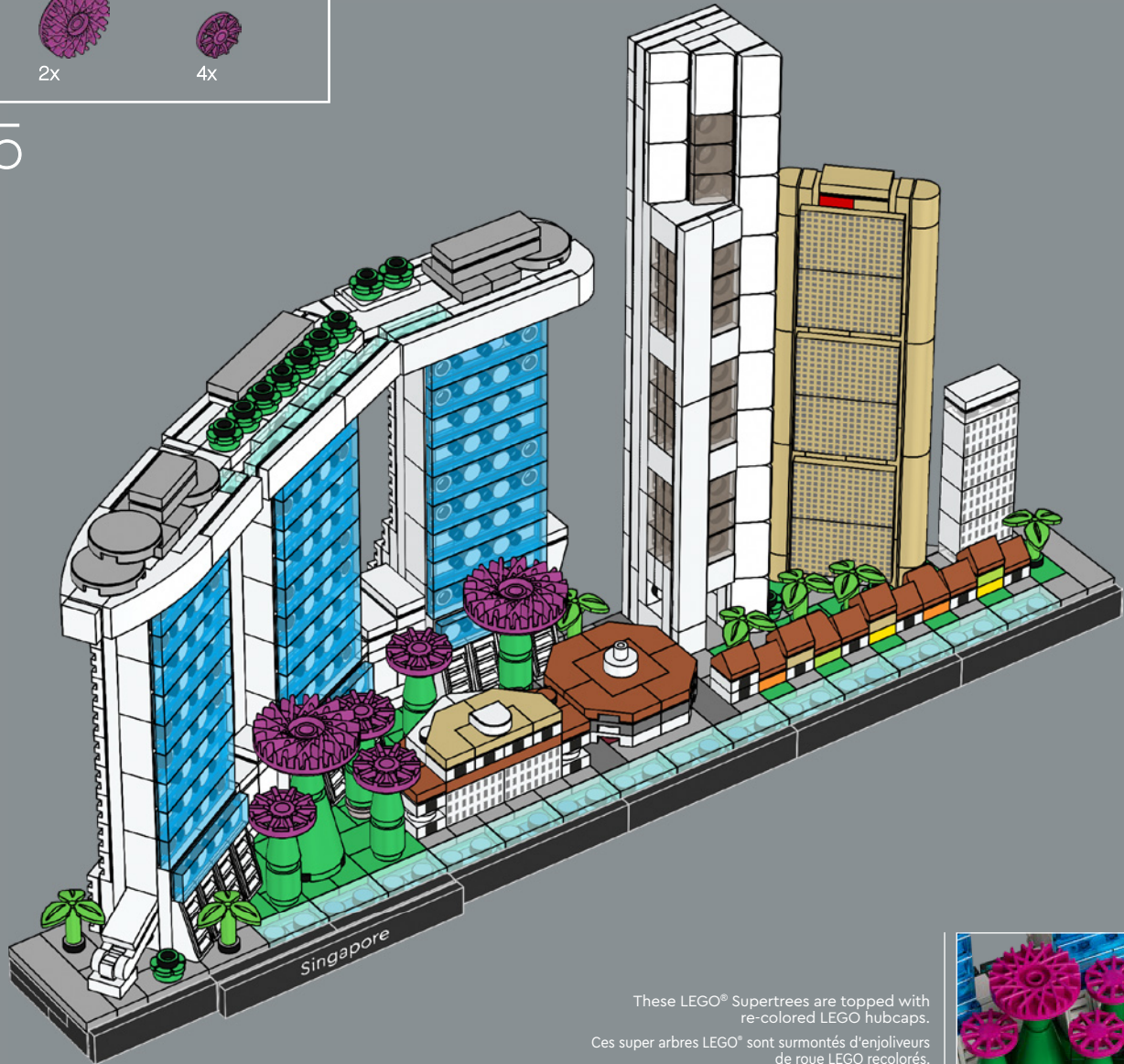

These LEGO® Supertrees are topped with re-colored LEGO hubcaps.  
Ces super arbres LEGO® sont surmontés d'enjoliveurs de roue LEGO recolorés.

Estos *superárboles* LEGO® están cubiertos con tapones de ruedas LEGO recolorados.

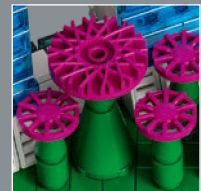



# FEEDBACK AND WIN

## FEEDBACK AND WIN

Your feedback will help shape the future development of this product series.

Please visit:

## FEEDBACK UND GEWINNEN

Dein Feedback trägt zur Weiterentwicklung dieser Produktreihe bei.

Geh auf:

## COMMENTEZ ET GAGNEZ

Vos commentaires nous aideront à concevoir les futurs produits de cette gamme.

Rendez-vous sur :

## COMENTA Y GANA

Tu opinión nos ayudará a dar forma al desarrollo de esta serie de productos en el futuro.

Visita:

## 反馈有奖

您的反馈将有助于我们在今后改进本系列产品。

请访问：

[LEGO.com/productfeedback](https://www.lego.com/productfeedback)

By completing, you will automatically enter a drawing to win a LEGO® set.

Terms & Conditions apply.

Durch Ausfüllen nimmst du automatisch an der Verlosung eines LEGO® Preises teil.

Es gelten die Teilnahmebedingungen.

En envoyant vos commentaires, vous serez automatiquement inscrit(e) à un tirage au sort qui vous permettra de remporter un prix LEGO®.

Offre soumise à conditions.

Al contestar, participarás automáticamente en el sorteo y podrás ganar un set LEGO®.

Sujeto a Términos y Condiciones.

完成我们的反馈调查，即可自动进入抽奖环节，赢取乐高® 套装。





























适用《条款和条件》。

LEGO and the LEGO logo are trademarks of the/son des marques de commerce du/son marcas registradas de LEGO Group. ©2022 The LEGO Group. All rights reserved/Tous droits réservés/Todos los derechos reservados.











Adam Reed Tucker is the co-developer of the LEGO® Architecture product line./Adam Reed Tucker est le codéveloppeur de la gamme de produits LEGO® Architecture./Adam Reed Tucker es el codesarrollador de la línea de productos LEGO® Architecture.

Made by LEGO System A/S under license from Gardens by the Bay.

MARINA BAY SANDS®

 4x 614101  
 1x 6186681  
 1x 6250591  
 15x 6202501  
 9x 302401  
 1x 6348055  
 11x 307001  
 2x 4504369  
 2x 4558952  
 29x 6218841  
 1x 300501  
 2x 6242241  
 5x 4626882  
 2x 6321349  
 1x 6132204  
 1x 6132203  
 3x 4179875  
 3x 4179874  
 13x 4547489  
 5x 4667575  
 72x 241201  
 4x 6058177  
 6x 6253517  
 2x 6285777  
 13x 302301  
 4x 6176240  
 1x 300401  
 12x 6023804

 6x 306901  
 1x 4532972  
 1x 6018774  
 2x 6070698  
 1x 302201  
 1x 4515364  
 15x 6223491  
 3x 362201  
 13x 362301  
 5x 4558168  
 8x 302101  
 2x 243101  
 2x 6045936

 1x 370101  
 9x 371001  
 4x 6102776  
 8x 302001  
 3x 663601  
 2x 366601  
 1x 416201  
 3x 447701  
 3x 383201  
 3x 4168072  
 2x 4119227

 3x 4159553  
 4x 6286329  
 2x 6365720  
 4x 6374151  
 2x 6374192  
 8x 6357613  
 1x 4114026  
 3x 6092587  
 1x 6372047  
 1x 6374166  
 2x 6265572  
 12x 6378425  
 6x 4113233

 6x 6375672  
 2x 302421  
 1x 4569056  
 4x 6315482  
 3x 302424  
 2x 302324  
 4x 614126  
 1x 6253695  
 6x 6196548  
 2x 6174243  
 9x 302326  
 4x 6052126  
 2x 362326  
 4x 302126  
 1x 302126

1x  
243126

3x  
371026

2x  
302026

4x  
663626

2x  
4160025

3x  
379526

1x  
6366690

2x  
447726

3x  
303526

13x  
6135287

6x  
306228

6x  
4529239

2x  
4558593

3x  
302428

1x  
6189162

7x  
6092586

6x  
306928

5x  
6023083

4x  
6378110

7x  
6235080

9x  
6374150

2x  
6143431

2x  
6104342

1x  
6360214

1x  
6360215

1x  
6360215

3x  
6315197

4x  
6253425

1x  
6074892

3x  
6240204

4x  
6254256

11x  
6252043

22x  
6240222

18x  
6251295

30x  
6252050

2x  
4524929

1x  
6240515

3x  
6245263

9x  
6254253

45x  
6252039

30x  
6240219

2x  
4621557

2x  
6373602

1x  
6374116

4x  
4539114

8x  
4211415

4x  
6052200

2x  
4211398

3x  
4211414

14x  
6066097

4x  
6217876

6x  
4211413

2x  
6313188

2x  
6177078

8x  
6211969

1x  
4211429

5x  
4558169

7x  
4211356

2x  
4211481

4x  
6164073

2x  
4210651

6x  
6372122

2x  
6212377

2x  
6336665

3x  
4653988

1x  
6218014

7x  
4633691

6x  
6097493

2x  
4655256

5x  
6332108

4x  
6104130

Customer Service  
Kundenservice  
Service Consommateurs  
Servicio Al Consumidor

LEGO.com/service or dial

🇧🇪 🇩🇰 🇩🇪 🇪🇸 🇫🇷 🇮🇹 🇯🇵 🇰🇷 🇸🇪 🇸🇯 🇺🇰  
: 00800 5346 5555  
🇨🇦 : 1-800-422-5346



