



NINJAGO

71787



2



WARNING: CHOKING HAZARD.
Small parts. Not for children under 3 years.

⚠ **AVERTISSEMENT : RISQUE D'ÉTOUFFEMENT.**
Contient des petites pièces. Ne convient pas aux enfants de moins de 3 ans.

⚠ **ADVERTENCIA: PELIGRO DE ASFIXIA.**
No recomendado para niños menores de 3 años. Contiene piezas pequeñas.



1

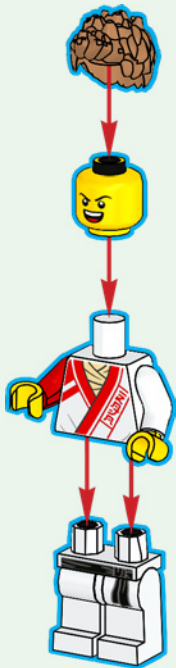

2

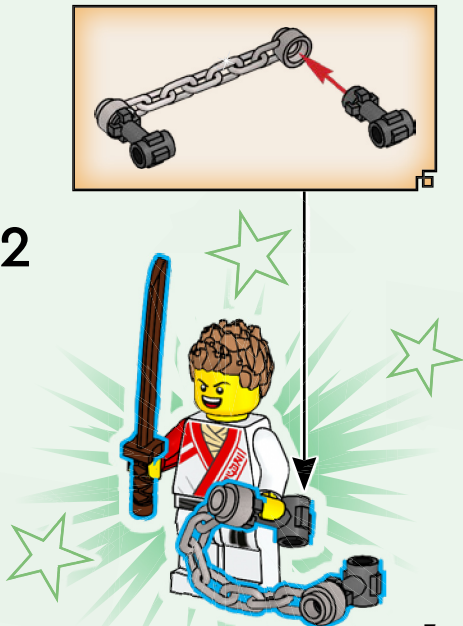

3

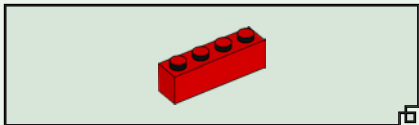
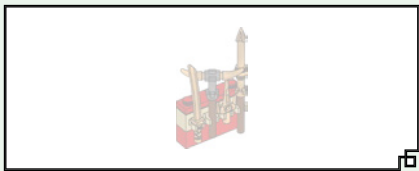

1

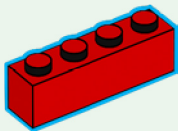

4



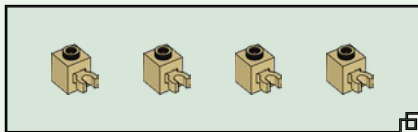

2

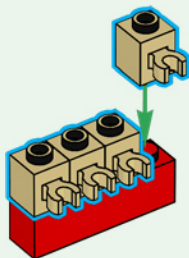

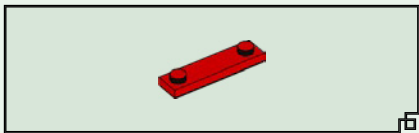

3

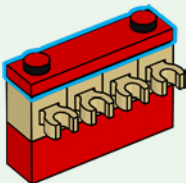

6





4

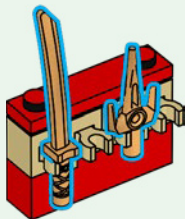

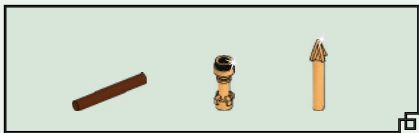

5

1

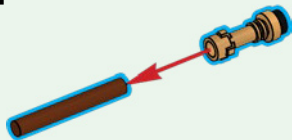

2



8



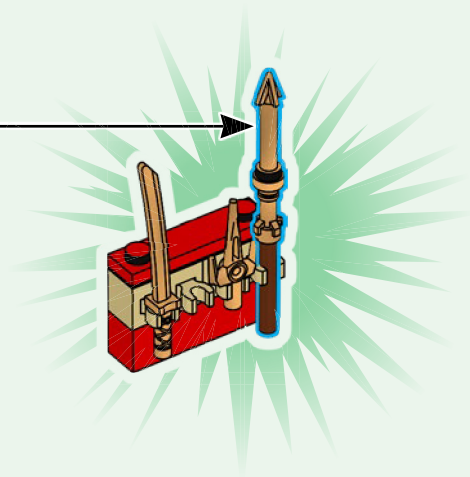

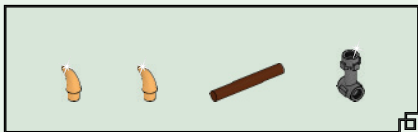

6

1

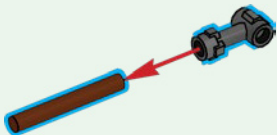

2

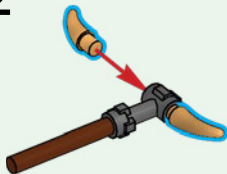

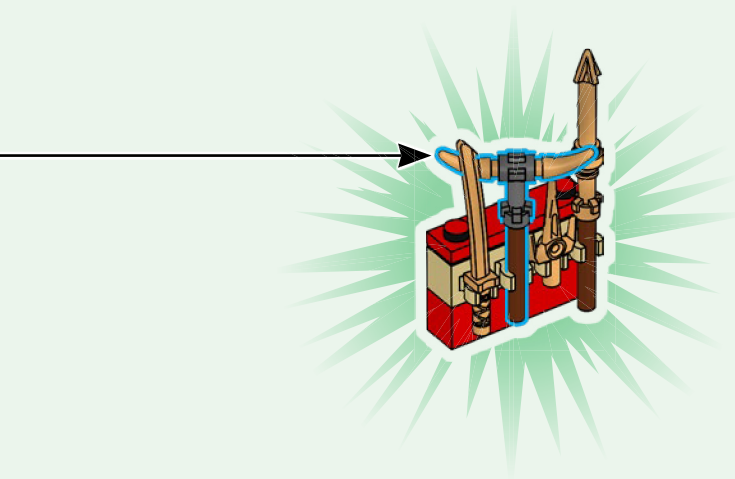

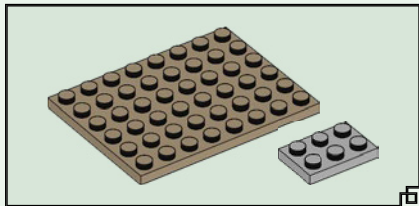
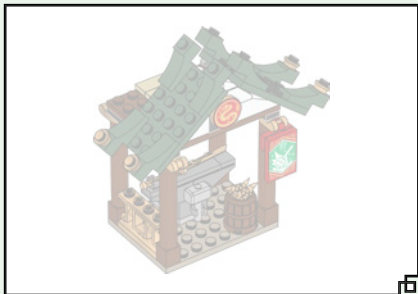

1

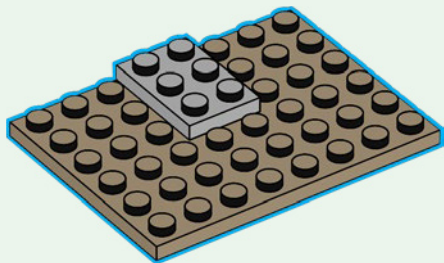

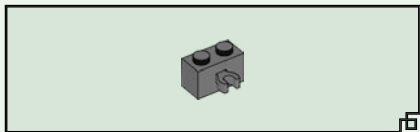

2

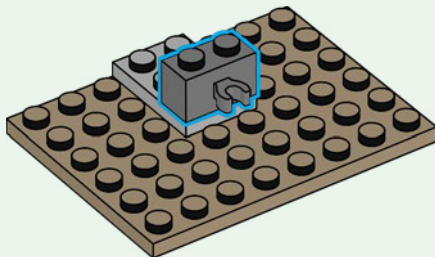

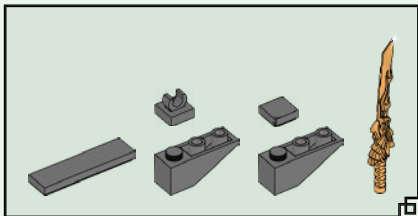

3

1

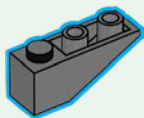

2

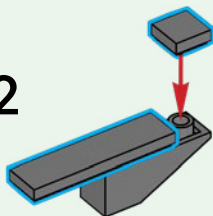

3

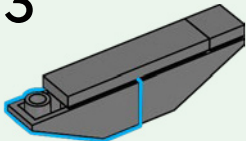

4

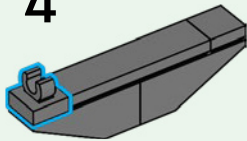

5

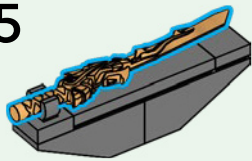

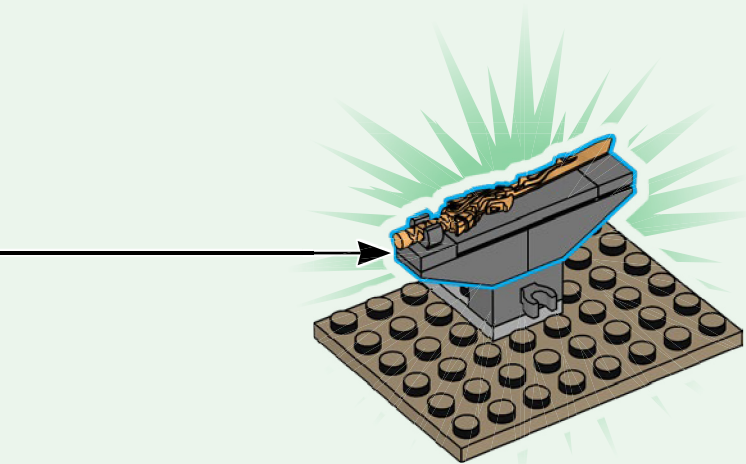

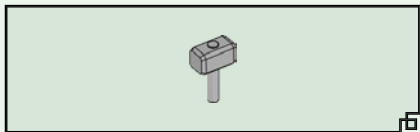

4

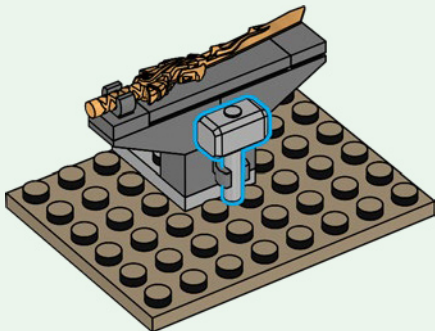

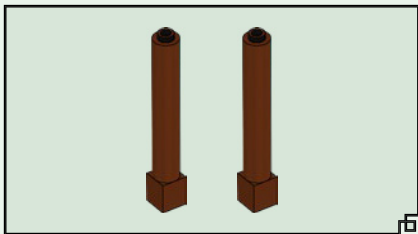

5

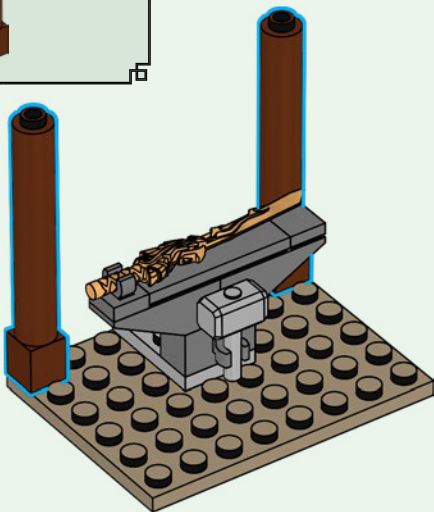

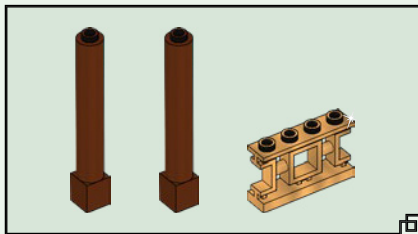

6

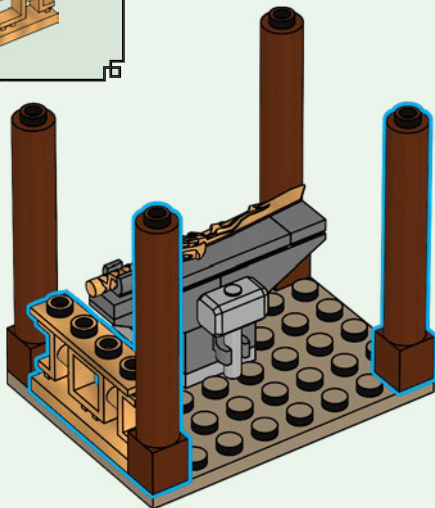

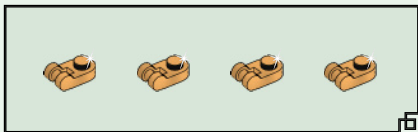

7

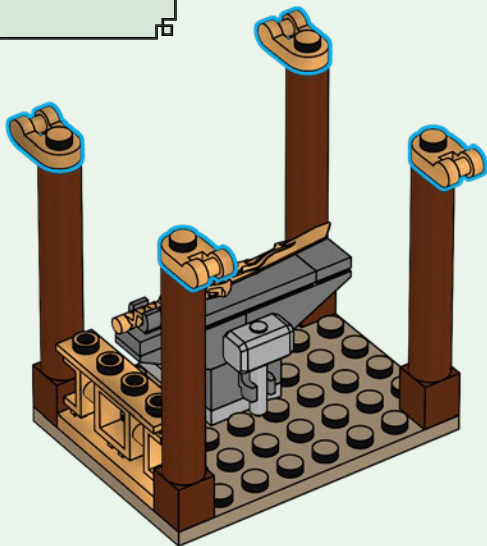

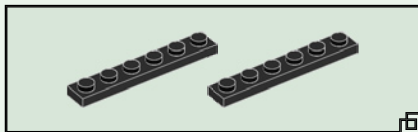

8

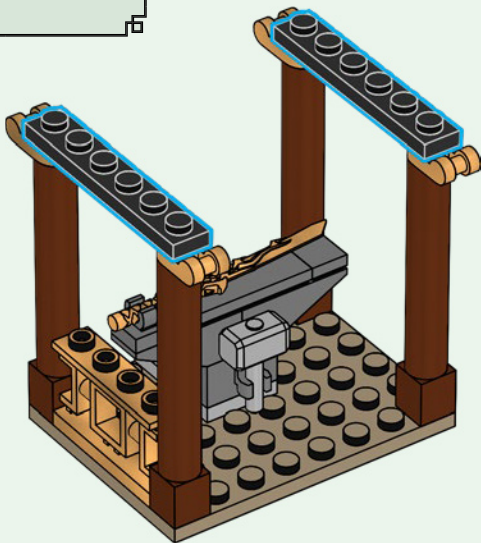



9

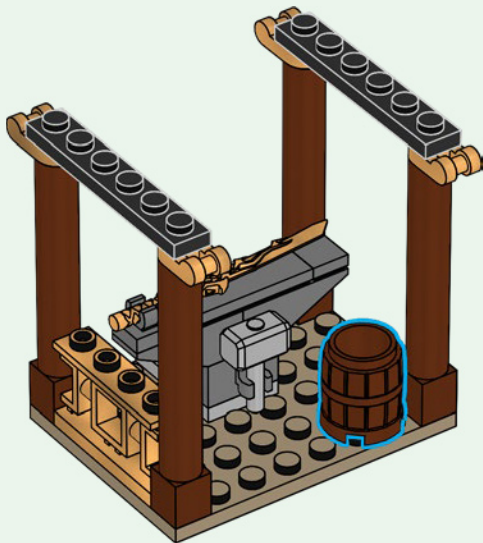

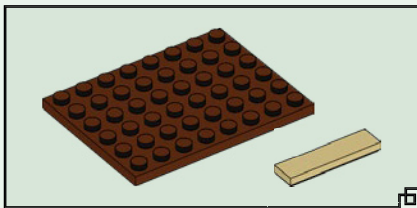

10

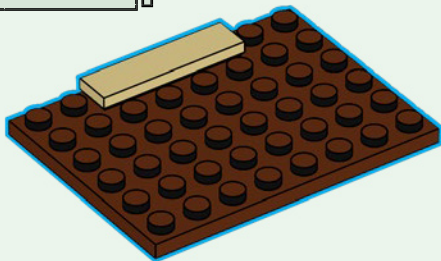

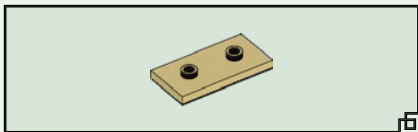

11

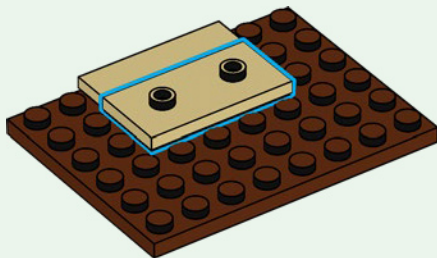

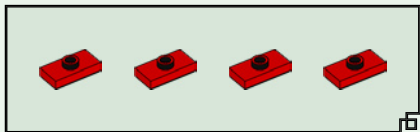

12

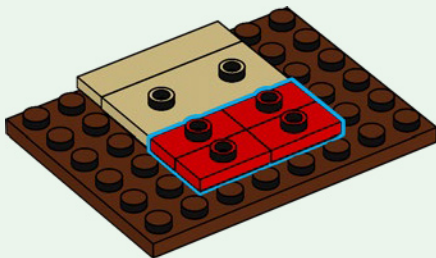

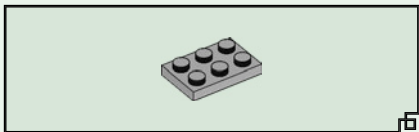

13

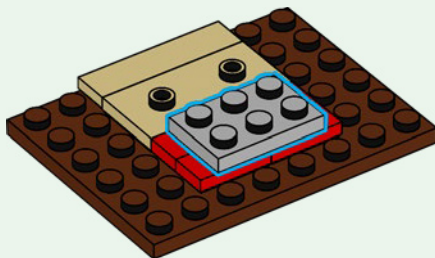

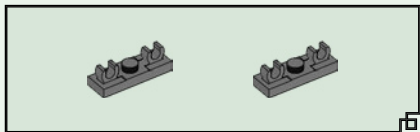

14

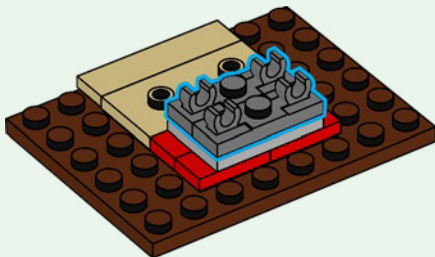

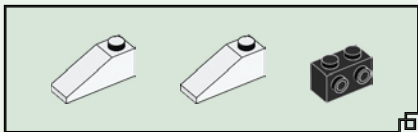

15

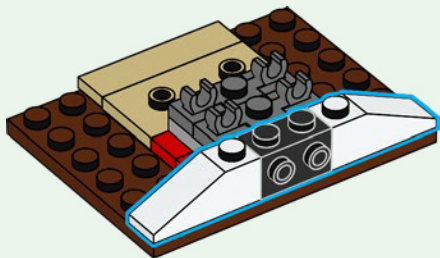

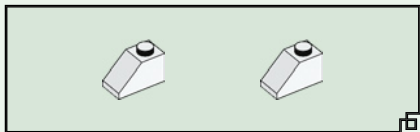

16

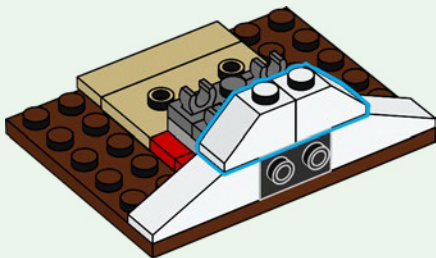

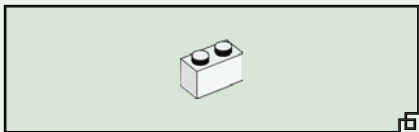

17

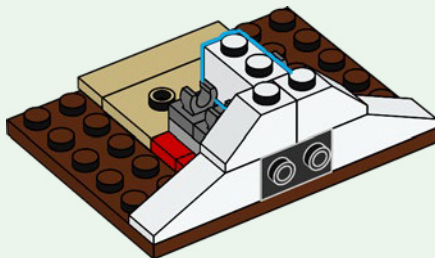

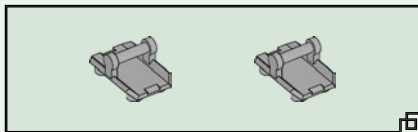

18

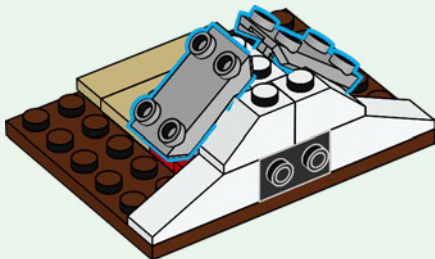



19

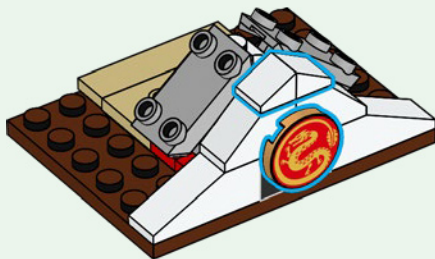

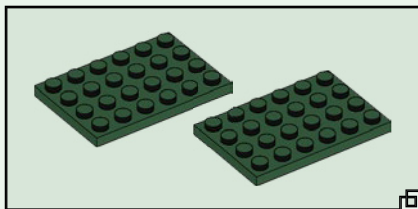
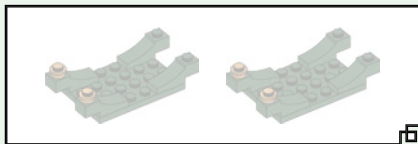

20

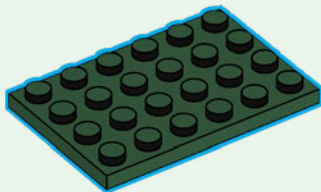
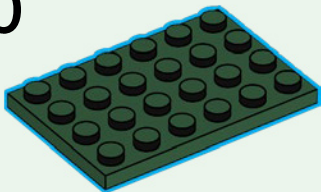

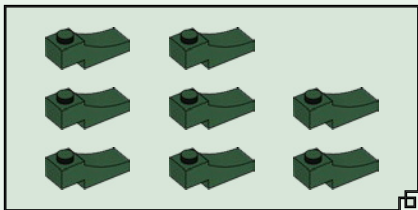

21

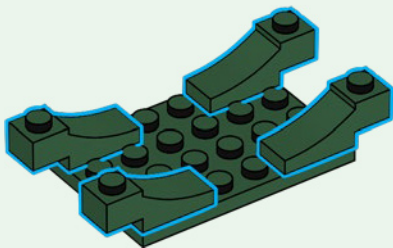
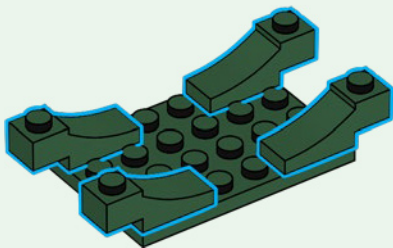



22

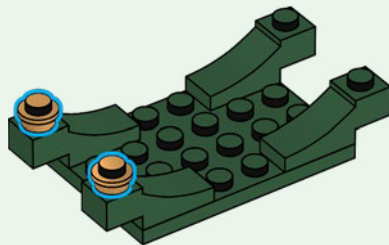
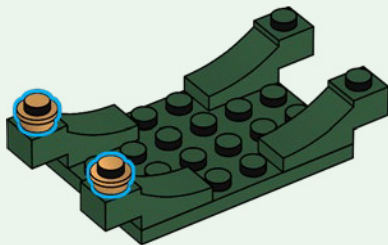

23

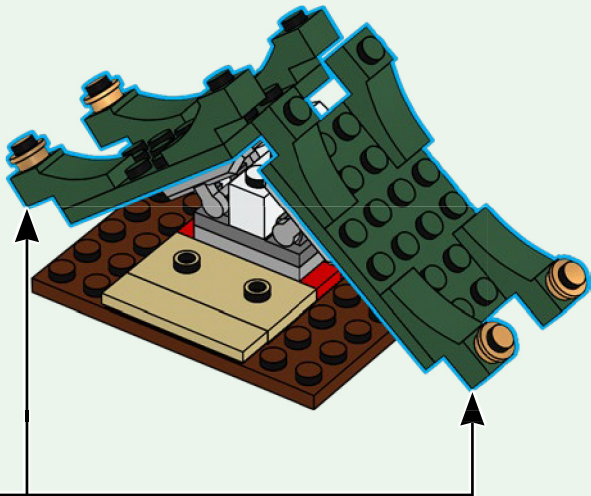
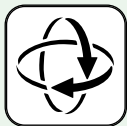

24

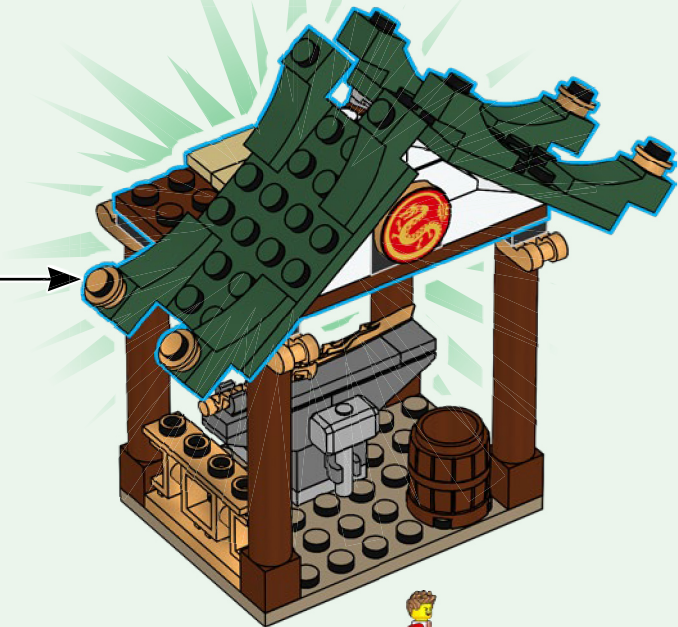

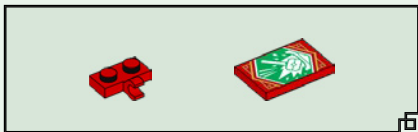

25

1



2







26

1

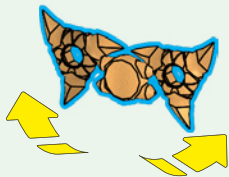

2



27



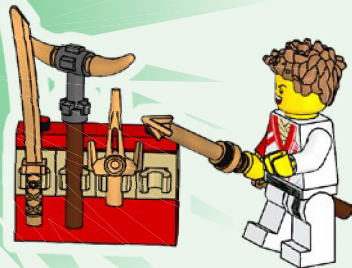

LEGO

NINJAGO



71785



71786



71787



71781



71782



71780



71784



71783

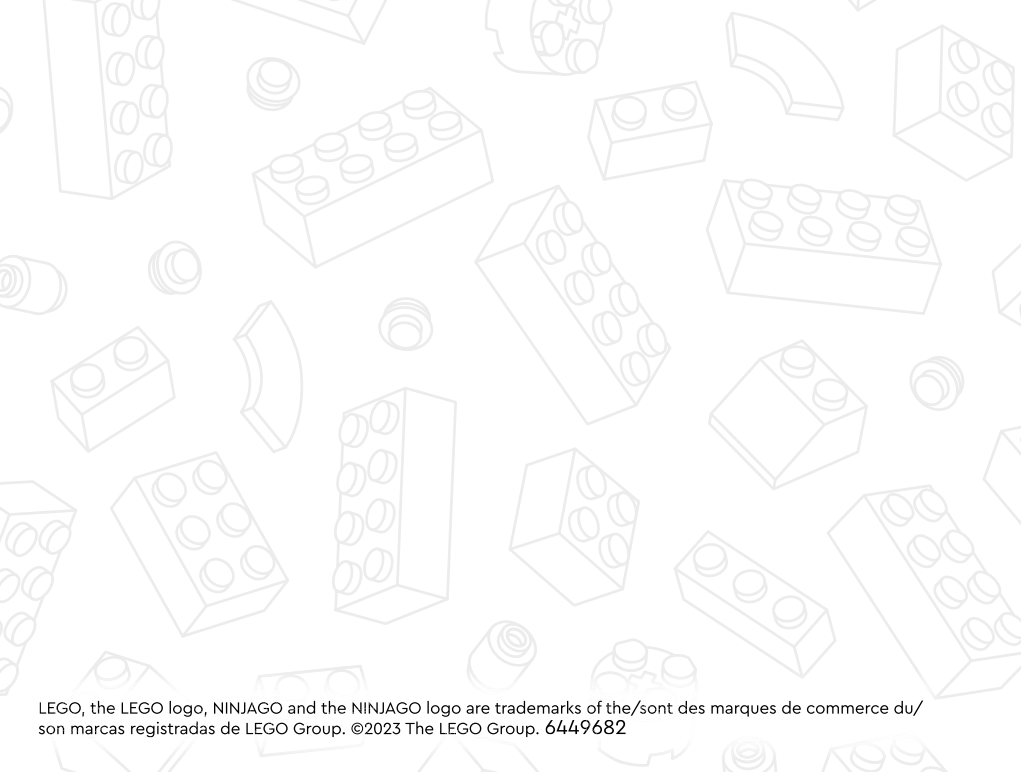

LEGO, the LEGO logo, NINJAGO and the NINJAGO logo are trademarks of the/sont des marques de commerce du/
son marcas registradas de LEGO Group. ©2023 The LEGO Group. 6449682