



P/N: 15G062394001AK V1.1

ASRock 13.3" SIDE PANEL KIT

With ASRock 13.3" Side Panel Kit, you can easily build a LCD display inside your PC case, which provides you with a sub screen for monitoring PC status or allows you to send messages, watch videos or do streaming at the same time. This IPS panel equipped with eDP interface reduces power consumption and meanwhile delivers great viewing experience.

Before You Begin

- Please make sure your PC case contains a transparent tempered glass side panel, with enough space to mount the eDP panel. Use the microfiber cloth to wipe the panel clean and identify the location you want to mount your screen.
Note: The transparency of your side panel may affect the display quality of your eDP panel.
- Make sure the motherboard of your system comes with an eDP connector. Please visit ASRock's website for the supported motherboards with eDP interface.

Installation Procedure

The illustrations in this guide are for reference purposes only and may not exactly match the model you purchase.

- Gently lift the 13.3" eDP screen panel, along with the two long brackets, from the box. Remove the brackets from both sides of the eDP panel.

ATTENTION! Two brackets are not clung to the panel. Beware of dropping the panel when you remove them.

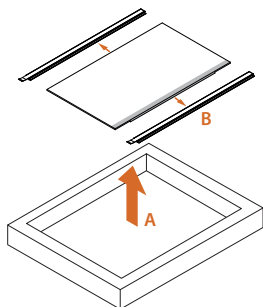

- Take out two mounting brackets and two retaining rubber strips from the box. Both are required for either the vertical or the horizontal display.

Note: For vertical display, we suggest you rotate the PC side panel 90 degrees during installation. Once the eDP panel is securely attached with the brackets and the rubber strips, rotate the PC side panel back to normal position.

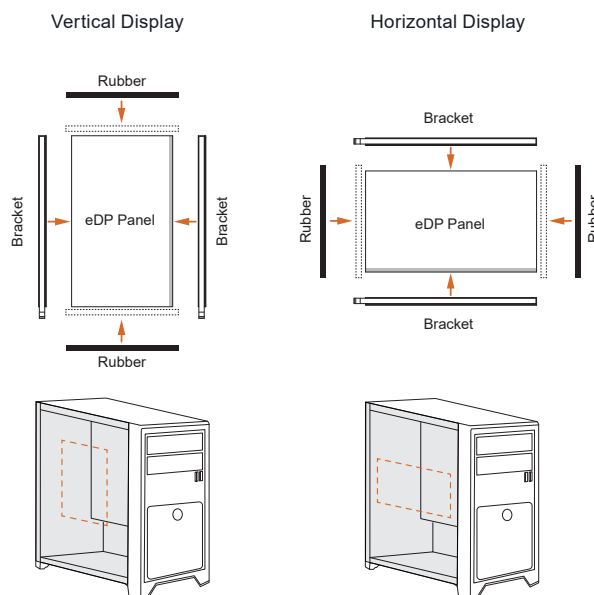

Package Contents

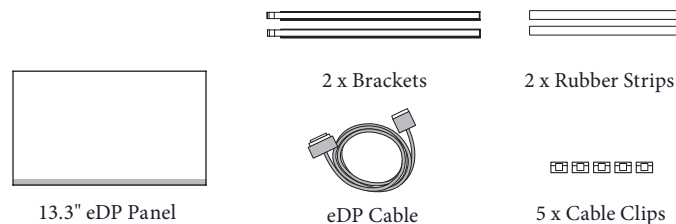

Specification

- Panel Size (inch): 13.3
- Aspect Ratio: 16:9
- Display Viewing Area (H x V): 93.76 x 165.24
- Display Surface: Anti-Glare
- Backlight Type: LED
- Panel Type: IPS
- Pixel Pitch: 0.153mm
- Resolution: 1920 x 1080
- Brightness (Typ.): 300 cd/m²
- Contrast Ratio (Typ.): 800:1
- Display Colors: 16.7M (8 bit)
- Refresh Rate (Max): 60 Hz
- Dimension (W x H x D): 300.3 x 177.6 x 2.3 mm

**For the updated and more information, please visit www.asrock.com.*

- Take one bracket. Peel the blue plastic liner off. Do not touch the adhesive surface.

Note: Do not peel off the black strip behind the blue plastic liner. The black strip allows you to easily remove the bracket.

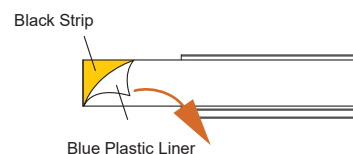

- Paste the bracket to the desired location on the internal side of the PC side panel. Press and hold the bracket for a few seconds to ensure adhesion. Be sure to leave enough space above, allowing the eDP panel to be placed.

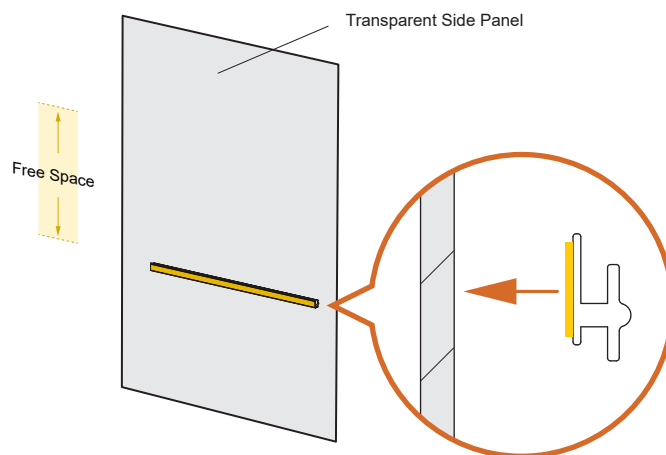

Dimensions of the 13.3" eDP Panel with Brackets and Rubbers Installed

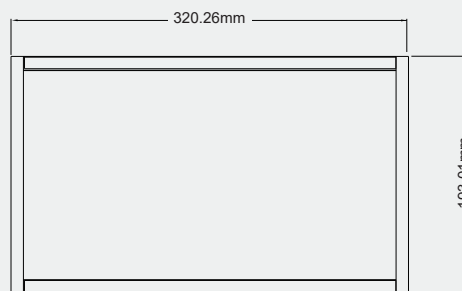

ATTENTION! Note the direction when you paste the bracket.

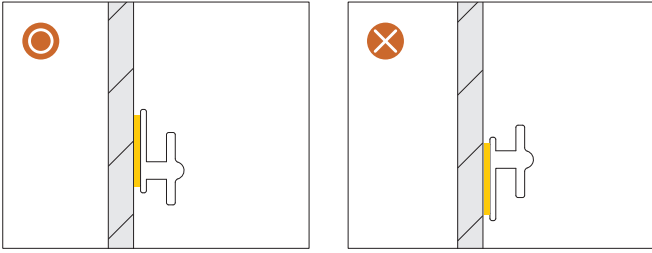

5. Install the other bracket on the top edge of the eDP panel. Make sure the screen is facing the same side as the sticker. Please note the direction as shown below.

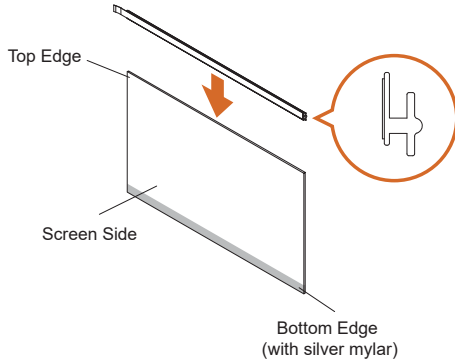

6. Peel the blue plastic liner off. Do not touch the adhesive surface.
Note: Do not peel off the black strip behind the blue plastic liner.



7. Hold the sides of the eDP panel assembly. Obliquely insert it into the groove of the bottom bracket. Then carefully push it toward the glass panel until the top bracket is firmly adhered.

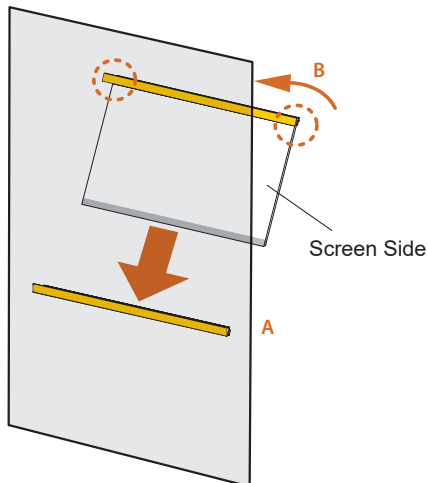

If you install them correctly, from the screen side, the silver mylar at the bottom of the eDP panel will be fully covered by the bracket.

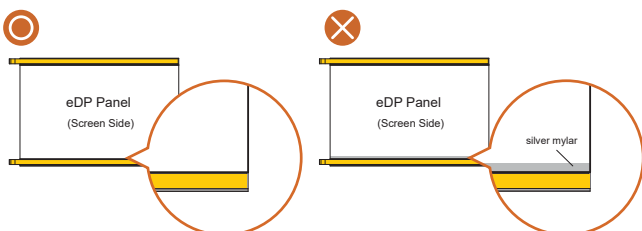

8. Peel off the paper liners from the rubber strips. Do not touch the adhesive surface. Paste the rubber strips closely along the edges of the eDP panel, so that the eDP panel is securely framed and won't shift or slide.

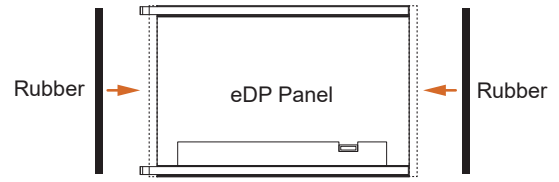

ATTENTION! Do not paste the rubber strip onto the black strip at the bracket end, so you can grasp and stretch the black strip to easily remove the bracket when needed.

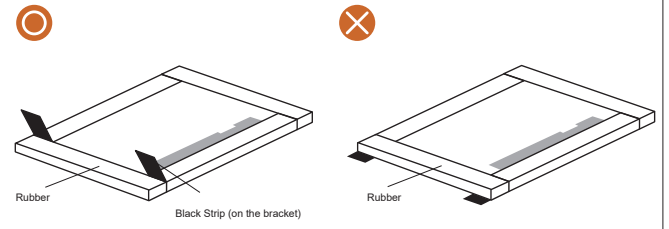

9. Connect the smaller end of the eDP cable to the eDP panel. To do so, open the cover on the flip-lock connector. Insert it into the connector on the back of the eDP panel. Then close the cover on the connector to secure it in place.

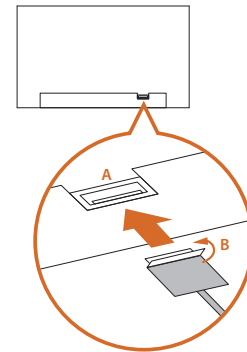

10. Connect the other end of the cable to the 40-pin eDP connector on the motherboard.

Note: For easier cable routing, we suggest you first connect the eDP cable to your motherboard before installing the motherboard into the case.

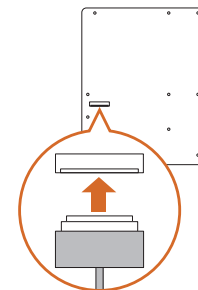

11. You can use the cable clips to manage your cable. It's done.

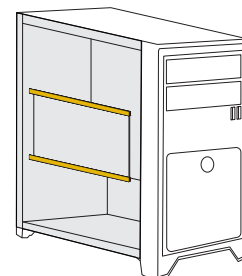

Before using your side panel, please set "Primary Graphics Adapter" to "Onboard" in the BIOS settings to ensure the display work properly. To do so, please go to "Advanced" > "Chipset Configuration" and set "Primary Graphics Adapter" to "Onboard". Then save the settings and restart the system.