

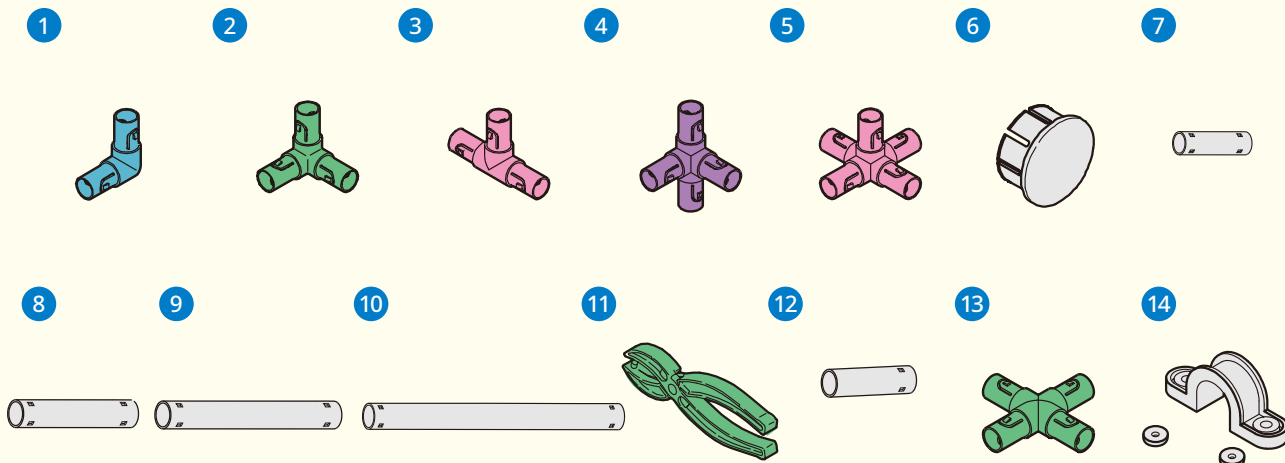

12 BIN TILTED STORAGE BINS FRAME

What's inside your kit:



NO.	DESCRIPTION	QTY.	ITEM NO.
1	E-CORNER CONNECTOR	2	1060-W10-A1B2
2	E-3-WAY CONNECTOR	4	1060-W10-B1G
3	E-T SHAPE CONNECTOR	16	1060-W10-C1K
4	E-4-WAY CONNECTOR	13	1060-W10-D1P
5	E-5-WAY CONNECTOR	2	1060-W10-E1K
6	E-TUBE END COVER	4	1060-W10-G1SR
7	E-105mm TUBE	16	1060-W17-C5SR
8	E-143mm TUBE	9	1060-W17-E8S
9	E-216mm TUBE	36	1060-W17-F2S
10	E-483mm TUBE	10	1060-W17-G1S
11	E-RELEASE PLIERS	1	1060-W85-M1G
12	E-105mm TUBE END SECTION	4	1061-W17-C6S
13	E-CROSS CONNECTOR	5	1136-W10-B1G
14	E-U CLAPM & WASHER	2	1136-W90-E2S

INSTRUCTION MANUAL

Assembled by an adult.

IMPORTANT:

This set is intended for adult assembly only. Please read all instructions carefully before beginning.

1. Keep unused parts in the marked bag(s) until required.
Some parts appear similar and may be confused.
2. Assemble each section separately - as shown in the exploded diagrams.
3. If parts need to be loosened, use the included "release pliers" to assist you.
4. After each section is complete, assemble the completed sections together into the final unit.

ASSEMBLY & DISASSEMBLY

· How to Assemble & Disassemble Tubes and Connectors

Note: Do not hold a tube or connector where the insertion takes place, fingers may be pinched.

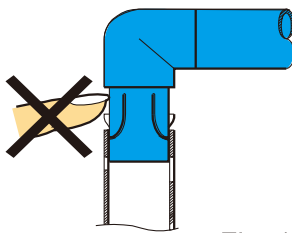

Fig. 1

- (1) Push the corner connector onto the tube and twist the tube until a "click" is heard.

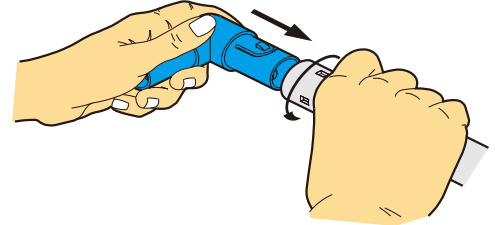

Fig. 2

- (2) Finish the assembly of both connectors with the tube in between. Then insert the connectors into two separate tubes to complete a panel. (Fig. 3-1)
Do not assemble the tubes and connectors one by one. (Fig. 3-2)

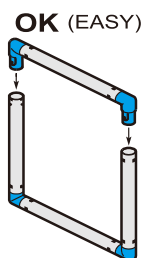

Fig. 3-1

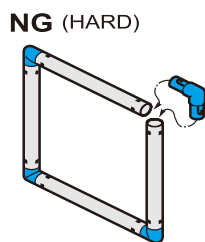

Fig. 3-2

- (3) Position the release plier nodes over the holes where the safety lock pins are visible. Squeeze gently to release the tube from the connector.

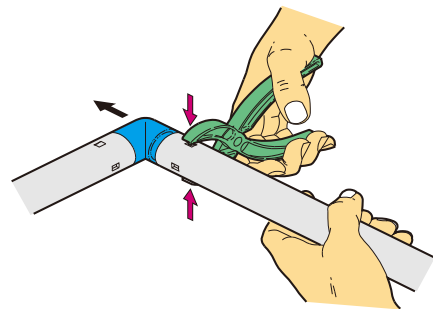
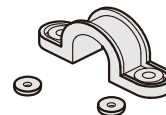

Fig. 4



•How to use U-Clamp Wall Attachment

If you want to fasten the storage frame to a wall, use the U-Clamp Wall Attachment and screws as shown in Figs. 5 & 6.

•How to use Tube End Cover for Tube

Insert Endcap into end of tube leg. (Fig. 7)

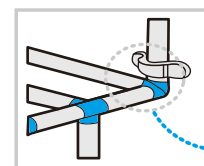

Fig. 5

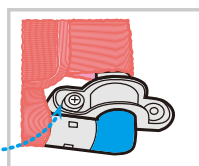

Fig. 6

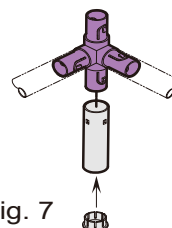





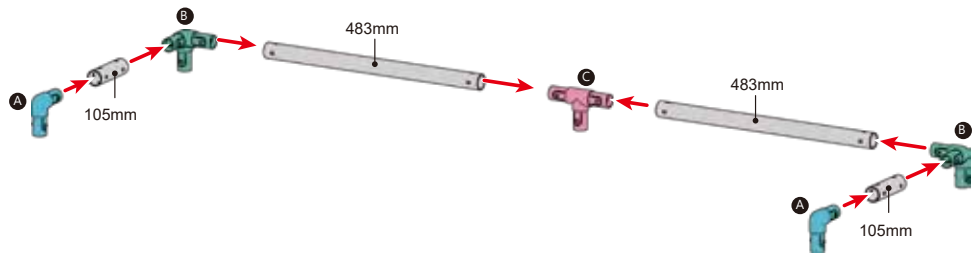

Fig. 7









12 BIN TILTED STORAGE BINS FRAME

1

- A  x2
- B  x2  105mm x2
- C  x1  483mm x2







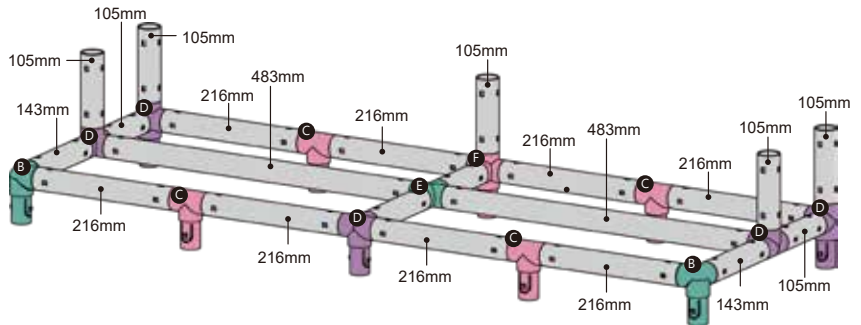



2

- B  x2
- C  x4
- D  x5
- E  x1
- F  x1
-  105mm x8
-  143mm x3
-  216mm x8
-  483mm x2







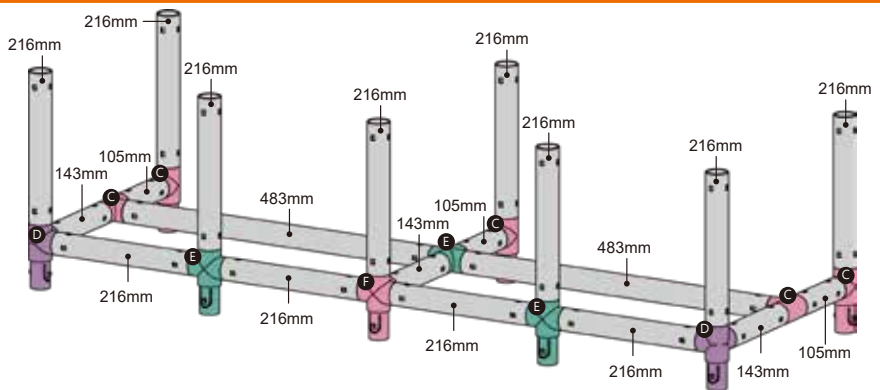

3

- C  x5
- D  x2
- E  x3
- F  x1
-  105mm x3
-  143mm x3
-  216mm x12
-  483mm x2



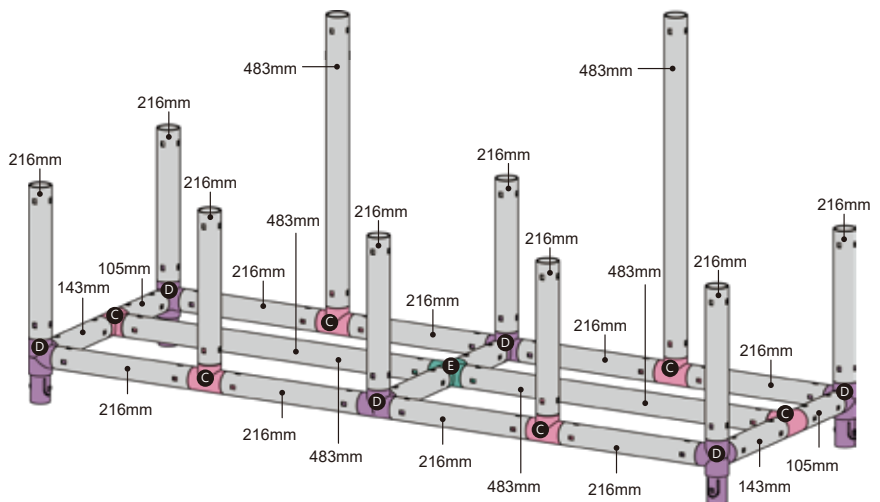

4

- C  x6
- D  x6
- E  x1
-  105mm x3
-  143mm x3
-  216mm x16
-  483mm x4



5

-  105mm Tube End Section x4
-  Tube End Cover x4



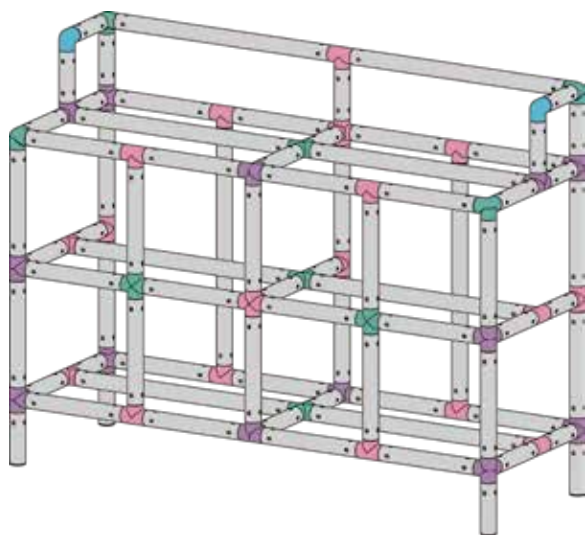
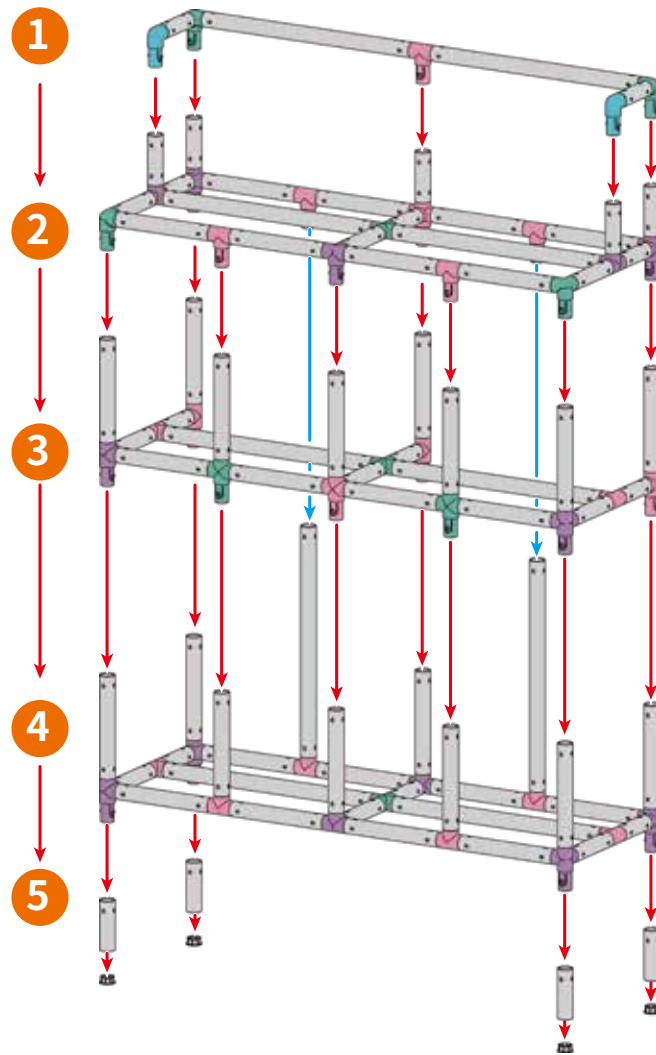

Done!

GENIUS TOY TAIWAN CO., LTD.
www.gigotoys.com

© 2021 Genius Toy Taiwan Co., Ltd. ALL RIGHTS RESERVED

R21#905-008S