

fischertechnik 

ROBOTICS

Bauanleitung
Assembly instruction
Instructions de montage
Bouwhandleiding
Instrucciones de construcción
Manual de montagem
Istruzioni di montaggio
Инструкция по сборке
安装说明书

Didactic Information
www.fischertechnik-eLearning.com
free download ↓



eLearning Portal

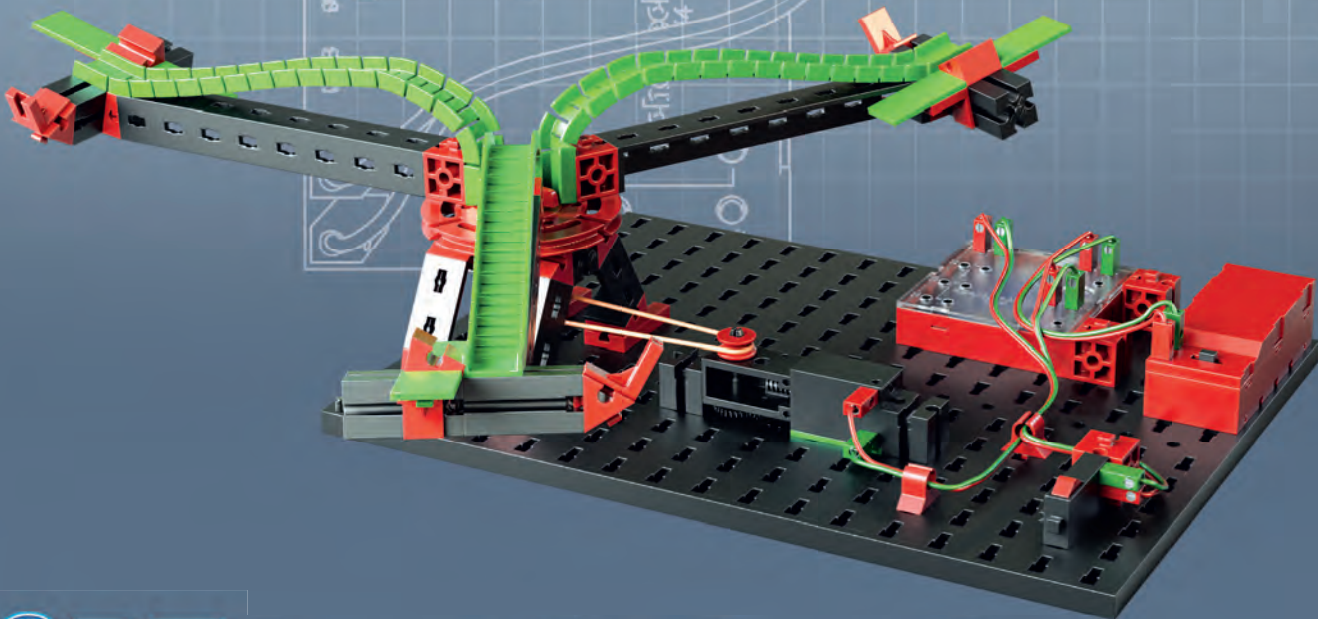
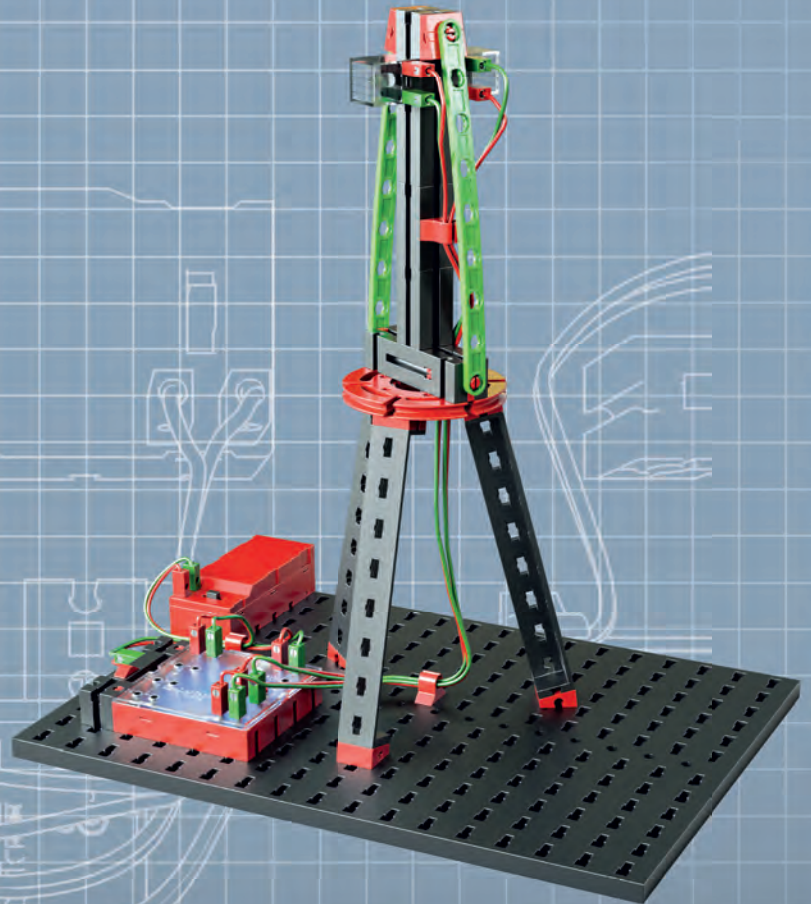

 **BT Smart Beginner Set**

Robotics  **BT Beginner**

12 MODELS



■ **Wichtig! Bitte beachten! Zwingend erforderlich!**

Steuerung der Modelle mit dem PC oder Tablet möglich:

Das fischertechnik eLearning-Portal enthält:

- Download der Steuerungssoftware zur Programmierung und Steuerung der Modelle dieses Baukastens: „ROBOPro Light“ für PC mit Windows 7, 8, 10.
- Sowie Didaktisches Begleitmaterial zur Installation der Software, Inbetriebnahme des „BT Smart Controllers“, Anleitung zur Verwendung der Software „ROBOPro Light“ und „ROBOPro Smart“, Aufgabenstellungen und Beispielprogramme für jedes Modell

App „ROBOPro Smart“ für Tablets/Smartphones mit Android ab 5.0 oder iOS zur Programmierung und Steuerung der Modelle dieses Baukastens im Google Play Store / App Store erhältlich

www.fischertechnik.de/elearning/BT-Smart-Beginner

www.fischertechnik.de/elearning/BT-Beginner

Am Besten gleich einloggen!

■ **Important! Please observe! Mandatory!**

Control of models possible with PC or tablet:

The fischertechnik eLearning portal contains:

- Download of control software to program and control the models of this kit: „ROBOPro Light“ for PC with Windows 7, 8, 10
- As well as didactic supporting documentation to install the software, start-up of the „BT Smart Controller“, instructions for the utilisation of the „ROBOPro Light“ and „ROBOPro Smart“ software, project definitions and sample programs for each model

„ROBOPro Smart“ app for tablets/smartphones with Android 5.0 onwards or iOS to program and control the models of this kit available at the Google Play Store / App Store

www.fischertechnik.de/elearning/BT-Smart-Beginner

www.fischertechnik.de/elearning/BT-Beginner

Why not log in right now!

■ **Important ! Veuillez noter ! Obligatoire !**

Commande des modèles possible avec PC ou tablette :

Le portail eLearning fischertechnik comprend :

- Téléchargement du logiciel de commande pour la programmation et commande des modèles de ce module : „ROBOPro Light“ pour PC avec Windows 7, 8, 10
- Ainsi que le matériel didactique pour l'installation du logiciel, la mise en service du „BT Smart Controller“, la notice d'utilisation du logiciel „ROBOPro Light“ et „ROBOPro Smart“, des tâches et exemples de programmes pour chaque modèle.

App „ROBOPro Smart“ pour tablettes/smartphones avec Android à partir de 5.0 ou iOS, disponible pour la programmation et la commande des modèles de ce module dans Google Play Store/App Store

www.fischertechnik.de/elearning/BT-Smart-Beginner

www.fischertechnik.de/elearning/BT-Beginner

Le mieux est de vous connecter maintenant !

■ **Belangrijk! In acht te nemen! Absoluut noodzakelijk!**

Besturing van de modellen mogelijk met pc of tablet:

De fischertechnik-e-learning-portal bevat:

- de download van de besturingssoftware voor het programmeren en besturen van de modellen van dit systeem: 'ROBOPro Light' voor pc met Windows 7, 8, 10
- didactische documentatie bij het installatie van de software en de ingebruikname van de 'BT Smart Controller', een handleiding voor het gebruik van de software 'ROBOPro Light' en 'ROBOPro Smart', taakstellingen en voorbeeldprogramma's voor elk model

De app 'ROBOPro Smart' voor tablets/smartphones met Android vanaf 5.0 of iOS voor het programmeren en besturen van de modellen van dit systeem is verkrijgbaar in de Google Play Store / App Store.

www.fischertechnik.de/elearning/BT-Smart-Beginner

www.fischertechnik.de/elearning/BT-Beginner

Het beste is om nu meteen in te loggen!

■ Importante! ¡A tener en cuenta! ¡Absolutamente necesario!

Control de los modelos posible con el ordenador o la tableta:

El portal e-Learning de fischertechnik contiene:

- descarga del software de control para programar y controlar los modelos de este módulo: «ROBOPro Light» para ordenadores con Windows 7, 8, 10,
- así como material didáctico adjunto para la instalación del software, puesta en marcha del «BT Smart Controllers», instrucciones sobre el uso de los softwares «ROBOPro Light» y «ROBOPro Smart», tareas y programas de muestra de cada modelo.

Aplicación «ROBOPro Smart» para tabletas/teléfonos inteligentes con Android a partir de 5.0 o iOS para la programación y el control de los modelos de este módulo disponible en la Google Play Store / App Store

www.fischertechnik.de/elearning/BT-Smart-Beginner

www.fischertechnik.de/elearning/BT-Beginner

¡Regístrese preferiblemente de inmediato!

■ Importante! Por favor, observar! Obrigatoriamente necessário!

Controle dos modelos com PC ou Tablet possível:

fischertechnik eLearning-Portal inclui:

- Download do software de controle para a programação e controle dos modelos desse kit: „ROBOPro Light“ para PC com Windows 7, 8, 10
- Bem como material de acompanhamento didático para a instalação do software, colocação em funcionamento do „BT Smart Controller“, instrução para o uso do software „ROBOPro Light“ e „ROBOPro Smart“, proposição de tarefas e programas de exemplo para cada modelo

App „ROBOPro Smart“ para Tablets/Smartphones com Android a partir de 5.0 ou iOS para a programação e controle dos modelos desse kit a ser obtido no Google Play Store / App Store

www.fischertechnik.de/elearning/BT-Smart-Beginner

www.fischertechnik.de/elearning/BT-Beginner

Faça o login imediatamente!

■ Importante! Attenzione! Assolutamente necessario!

Possibile comando dei modelli con PC o tablet:

Il portale di apprendimento online fischertechnik contiene:

- Il software di comando da scaricare per la programmazione e il comando dei modelli di questo modulo: “ROBOPro Light” per PC con Windows 7, 8, 10
- I materiali didattici di supporto per l’installazione del software e la messa in funzione del “BT Smart Controller”, la guida per l’impiego di software “ROBOPro Light” e “ROBOPro Smart”, scopi e programmi esemplificativi per ogni modello

L’app “ROBOPro Smart” per tablet/smartphone con Android da 5.0 o iOS per la programmazione e il comando dei modelli di questo modulo è disponibile in Google Play Store / App Store

www.fischertechnik.de/elearning/BT-Smart-Beginner

www.fischertechnik.de/elearning/BT-Beginner

Effettuare preferibilmente subito l’accesso!

■ Важно! Обратите внимание! Абсолютно необходимо!

Возможно управление моделями при помощи компьютера или планшета:

Портал fischertechnik eLearning:

- позволяет скачать управляющие программы для программирования и управления моделями этого блока: «ROBOPro Light» для компьютера с Windows 7, 8, 10
- а также содержит руководство по установке программ, ввода в эксплуатацию «BT Smart Controller», инструкцию по применению программ «ROBOPro Light» и «ROBOPro Smart», задания и образцы программ для каждой модели

Приложение «ROBOPro Smart» для планшетов/смартфонов с Android, начиная с 5.0 версии, iOS, для программирования и управления моделями этого блока можно скачать в Google Play Store / App Store

www.fischertechnik.de/elearning/BT-Smart-Beginner

www.fischertechnik.de/elearning/BT-Beginner

Зарегистрируйтесь прямо сейчас!

■ 重要消息！请注意！不可错过！

现在已经可以通过个人电脑或平板电脑来操纵模块：

费舍尔科技的电子学习门户网站包含：

- 下载可用于对积木的模块进行编程和操控的控制软件：：适用安装有 Windows 7，8，10 操作系统个人电脑的“ROBOPro Light”

- 以及安装该软件的教学材料，“BT Smart Controllers”的试用版，“ROBOPro Light”和“ROBOPro Smart”的使用说明，为每个模块提供的任务设置和程序示例。

为装有 Android 5.0，iOS 的平板电脑/智能手机提供的应用程序“ROBOPro Smart”可以对这些积木的模块进行编程和操控，这个程序可以在谷歌 Play 商店 / 苹果App Store 上获得。

www.fischertechnik.de/elearning/BT-Smart-Beginner

www.fischertechnik.de/elearning/BT-Beginner

立即登录！

Inhalt
Contents
Contenu

Inhoud
Contenido
Conteúdo

Contenuto
Содержание
目录

Einzelteilübersicht / Spare parts list / Liste des pièces détachées / Onderdelenoverzicht / Lista da peças / Resumo de peça individual /
Singoli componenti / Перечень деталей / 零件概览 3

Montagetipps / Tips for assembly / Tuyaux pour le montage / Montagetips / Consejos para el montaje / "Dicas" para montagem /
Consigli per il montaggio / Советы по сборке / 装配建议 4



Karussell / Merry-go-round / Manège /
Draaimolen / Tiovivo / Carrossel / Giostra /
Карусель / 旋转木马 7

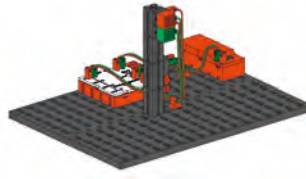

Fußgängerampel / Pedestrian light /
Feu de signalisation pour piétons /
Voetgangersstoplicht / Semáforo para peatones /
Semáforo para pedestres / Semaforo pedonale /
Светофор для пешеходов /
行人交通信号灯 12



Leuchtturm mit Blinklicht / Lighthouse with blinking
light / Phare à feu clignotant / Vuurtoren met
knipperlicht / Faro con luz intermitente / Torre de
iluminação com luz intermitente / Faro con luce
lampeggiante / Маяк с мигающим
светом / 带闪光信号灯的灯塔 15



Kühlschrank / Refrigerator / Réfrigérateur /
Koelkast / Nevera / Refrigerador /
Frigorifero / Холодильник /
冰箱 19



Waschmaschine / Washing machine / Lave-linge /
Wasmachine / Lavadora / Máquina de lavar roupa /
Lavatrice / Стиральная машина /
洗衣机 23

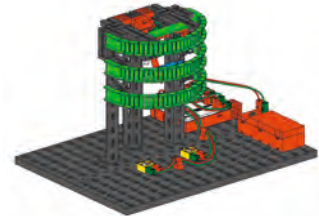

Händetrockner / Hand dryer / Sèche-mains /
Handdroger / Secador de manos / Secador de mãos /
Apparecchio asciugamani / Сушилка для рук /
干手机 28

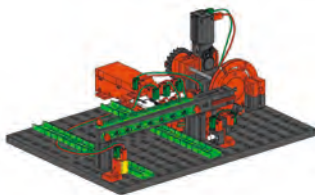

Schranke / Barrier / Barrière / Kasten / Barrera /
Barreira / Barriera / Шлагбаум / 道口栏杆
..... 32



Stanze mit Sicherheitsschalter / Punch with safety switch /
Poinçon avec interrupteur de sécurité / Stans met veilig-
heidsschakelaar / Punzonadora con interruptor de seguridad
/ Punção com interruptor de segurança / Punzonatrice con
interruttore di sicurezza / Штамповочный пресс с
защитным выключателем / 带安全开关的冲
压机 36

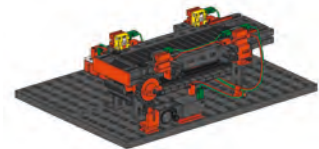

Förderband / Conveyor belt / Bande transporteuse /
Transportband / Cinta transportadora /
Correia transportadora / Nastro trasportatore /
Ленточный транспортер / 输送带 40



Förderband mit Stanze / Conveyor belt with punch /
Bande transporteuse avec poinçon / Transportband met
stans / Cinta transportadora con punzonadora / Correia
transportadora com punção / Nastro trasportatore con
punzonatrice / Ленточный транспортер со
штамповочным прессом / 带冲压机的
输送带 45



Fahrroboter / Mobile robot / Véhicule robot /
Rijrobot / Robot desplazable / Robò condutor /
Robot mobile / Робот-автомобиль /
机器人车 49



Hinderniserkenner / Hindrance detector / Détecteur
d'obstacles / Obstakeldetector / Detector de obstáculos
/ Identificador de obstáculos / Rilevatore di ostacoli /
Обнаружитель препятствий /
障碍物识别车 53















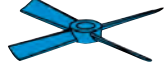

Einzelteilübersicht
Spare parts list
Liste des pièces détachées



Onderdelenoverzicht
Lista da piezas
Resumo de peça individual

Singoli componenti
Перечень деталей
零件概览

	31 010 7 x
	31 011 7 x
	31 019 2 x
	31 021 2 x
	31 031 1 x
	31 058 2 x
	31 060 2 x
	31 061 2 x
	31 064 2 x
	31 078 2 x
	31 082 2 x
	31 336 16 x
	31 337 16 x
	31 360 1 x
	31 426 2 x
	31 436 2 x
	31 597 2 x
	31 779 2 x

	31 790 44 x
	31 848 4 x
	31 981 8 x
	31 982 20 x
	31 983 2 x
	32 064 7 x
	32 330 2 x
	32 850 7 x
	32 879 7 x
	32 881 8 x
	32 985 1 x
	35 031 2 x
	35 049 8 x
	35 066 1 x
	35 073 1 x
	35 079 1 x
	35 084 1 x
	35 086 2 x

	35 087 1 x
	35 088 1 x
	35 945 1 x
	35 969 5 x
	36 134 2 x
	36 293 3 x
	36 323 4 x
	36 334 2 x
	36 337 1 x
	36 443 1 x
	36 920 5 x
	36 981 1 x
	37 237 4 x
	37 468 7 x
	37 636 1 x
	37 679 9 x
	37 681 1 x
	37 783 2 x

	38 240 3 x
	38 416 2 x
	38 423 10 x
	38 464 1 x
	128 659 90 x
	135 719 1 x
	136 775 1 x
	137 096 2 x
	143 234 3 x
	146 532 1 x
	146 533 2 x
	156 504 7 x
	161 944 1 x
	162 135 2 x
	163 041 5 x
	163 042 2 x

Montagetipps
Tips for assembly
Tuyaux pour le montage

Montagetips
Consejos para el montaje
"Dicás" para montagem

Consigli per il montaggio
Советы по сборке
装配建议

Kabel und Stecker
 Plugs and cables
 Fiches et des câbles

Stekkers en cables
 Enchufes en cables
 Cabos e contatos

Cavi e connettori
 Провода и штекеры
 电缆和插头

1

2 x 15 cm
 4 x 25 cm
 2 x 35 cm

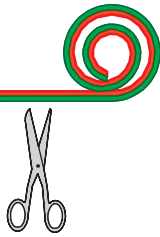

2



3

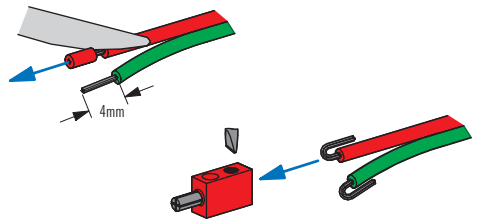

4

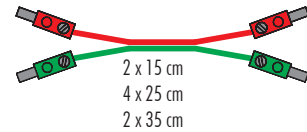

2 x 15 cm
 4 x 25 cm
 2 x 35 cm

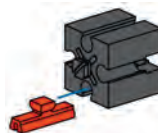
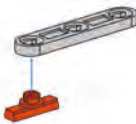

1



2



2 x

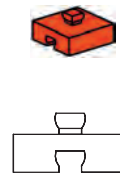
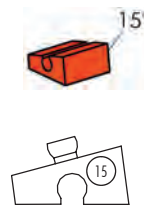
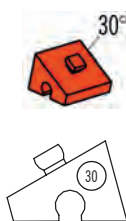
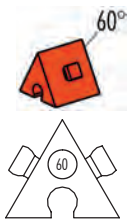

Fototransistor
 Phototransistor
 Phototransistor
 Fototransistor
 Fototransistores
 Fototransistor
 Fototransistor
 Фототранзистор
 光电晶体管

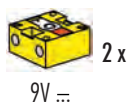

2 x

9V ...

Achtung: Beim Anschluß auf richtige Polung achten. Rot = +
 Caution: Make sure the terminals are connected correctly. Red = +
 Attention: lors du raccordement, veiller à ce que la polarisation soit exacte, rouge = +
 Pas op: let bij het aansluiten op de juiste polariteit, rood = +
 Atención: al conectar, procurar que los polos estén correctamente colocados, roja = +
 Atenção: Por ocasião da conexão atentar para a polaridade correta. Vermelho = +
 Attenzione: nel collegamento osservare la corretta polarità. Rosso = +
 Внимание: при подключении соблюдать полярность. Красный = +
 注意: 连接时应注意极性正确。红色 = +

Lichtschraken LED
 Light barriers LED
 LED barrières photoélectriques
 Lichtsluis-LED
 Barreras de luz LED
 Células fotoeléctricas de LED
 Barrière photoélectrique LED
 Световой барьер LED
 光电LED

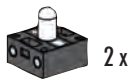

2 x

9 V ... / 0,01 A

Achtung: Beim Anschluß auf richtige Polung achten.
 Caution: Make sure the terminals are connected correctly.
 Attention: lors du raccordement, veiller à ce que la polarisation soit exacte.
 Pas op: let bij het aansluiten op de juiste polariteit.
 Atención: al conectar, procurar que los polos estén correctamente colocados.
 Atenção: Por ocasião da conexão atentar para a polaridade correta.
 Attenzione: nel collegamento osservare la corretta polarità.
 Внимание: при подключении соблюдать полярность.
 注意: 连接时应注意极性正确。

- Alle Einzelteile, insbesondere bewegliche Teile sind falls notwendig zu warten und zu reinigen.
- All components, especially moving parts, should be maintained and cleaned as necessary.
- Toutes les pièces détachées et en particulier les pièces mobiles, sont, si nécessaire, à entretenir et à nettoyer.
- Alle onderdelen, vooral de bewegende delen, kunnen, indien noodzakelijk, onderhouden en gereinigd worden.
- Es necesario limpiar y mantener en buen estado todas las diferentes piezas - especialmente las piezas móviles.

- Caso necessário, todas as peças individuais, especialmente peças móveis, tem que ser submetidas à manutenção e ser limpas.
- Se necessario, tutti i singoli componenti, soprattutto le parti mobili, si devono eventualmente sottoporre a manutenzione e pulizia.
- Все детали, особенно подвижные, требуют ухода и чистки.
- 必要时应保养和清洁所有零件, 尤指运动部件。

Sicherheitshinweise Safety Information Consignes de sécurité

Veiligheidsrichtlijnen Indicaciones de seguridad Observações sobre segurança

Informazioni per la sicurezza Указания по технике безопасности 安全指南

- Das Spielzeug darf nur mit einer der folgenden fischertechnik Energiequellen benutzt werden:
Art.-Nr.: 135719 Batteriehalter 9V oder Art.-Nr.: 35537 Accu Pack 8,4V.
- The toy may only be used with one of the following fischertechnik energy sources:
Art No.: 135719 battery tray 9V or Art No.: 35537 Accu Pack 8,4V.
- L'utilisation de ce jouet n'est permis qu'avec l'une des sources d'énergie fischertechnik suivantes:
Art. n° : 135719 support de pile 9 volts ou Art. n° : 35537 pack d'accumulateurs 8,4 volts.
- Het speelgoed mag uitsluitend met een van de volgende fischertechnik energiebronnen worden gebruikt: art.nr.: 135719 batterijhouder 9V of art.nr.: 35537 accupack 8,4V
- El juguete se debe utilizar únicamente con una de las siguientes fuentes de energía:
Art. No. 135719 soporte de pila de 9V o Art. No. 35537 paquete acumulador de 8,4V.
- O brinquedo somente pode ser utilizado com uma das seguintes fontes de energia da fischertechnik: art. n.º: 135719 Suporte de bateria de 9 V ou art. n.º: 35537 Bloco de bateria de 8,4V.
- Questo giocattolo può essere utilizzato solo con le seguenti fonti di energia fischertechnik:
cod. prod.: 135719 portabatteria da 9V oppure cod. prod.: 35537 confezione batterie da 8,4V.
- Игрушку можно использовать только с одним из следующих источников энергии от fischertechnik: арт. №: 135719 держатель батарейки 9В или арт. №: 35537 Accu Pack 8,4В
- 该玩具只允许使用如下的慧鱼 (fischertechnik) 能量源：商品号：135719，9V 电池夹，或者商品号：35537，8.4V 电池套件 (Accu Pack)

- Die Modelle dürfen nur an Geräte der Schutzklasse II angeschlossen werden, die mit dem entsprechenden Symbol gekennzeichnet sind.
- Ensure that the models are connected only to equipment rated in protection category II and marked with the appropriate symbol.
- Le raccordement des maquettes est uniquement permis à des appareils dotés de la catégorie de protection II qui portent le pictogramme respectif.
- De modellen mogen alleen op apparaten uit beschermingsklasse II worden aangesloten, die zijn voorzien van het bijbehorende symbol.
- Los modelos sólo pueden ser conectados a aparatos de clase de protección II que están identificados con el símbolo correspondiente.
- Os modelos somente devem ser conectados nos aparelhos da classe de proteção II, que são identificados com o símbolo correspondente.
- I modelli devono essere collegati solo ad apparecchi della classe di protezione II, contrassegnati con il relativo simbolo.
- Модели можно подключать только к приборам класса защиты II, обозначенным соответствующим знаком.
- 这些模型只允许连接到具有防护等级 II 的装置上，这类装置被用相应的符号进行了标识。

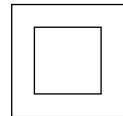

- **Elektromagnetische Störungen**
Sollte der Controller durch externe elektromagnetische Einflüsse gestört werden, kann er nach Ende der Störung bestimmungsgemäß weiter benutzt werden. Eventuell muss die Stromversorgung kurz unterbrochen und der Controller neu gestartet werden.
- **Electromagnetic Interference**
If the Controller is affected by external electromagnetic influences, it can still be used for the purpose intended after the end of the interference. It is possible that the power supply will have to be interrupted for a short time and the Controller restarted.
- **Interférences électromagnétiques**
L'emploi conforme à l'usage prévu du Controller perturbé par des interférences électromagnétiques externes est possible après l'élimination de l'origine de la perturbation. Il se pourrait cependant qu'il soit requis d'interrompre l'alimentation en courant brièvement et de redémarrer le Controller.
- **Elektromagnetische storingen**
Als de Controller door externe elektromagnetische invloeden wordt gestoord, kan deze na het verdwijnen van de storing volgens voorschrift verder worden gebruikt. Eventueel moet de voedingsspanning kort worden onderbroken en de Controller opnieuw worden gestart.
- **Interferencias electromagnéticas**
En caso que el Controller sea interferido por influencias electromagnéticas externas, tras finalizar la interferencia puede continuar siendo utilizado para los fines previstos. Eventualmente se debe interrumpir brevemente la alimentación de corriente y el Controller ser reiniciado.
- **Perturbações eletromagnéticas**
Se o Controller for perturbado devido a influências externas eletromagnéticas, ele pode continuar a ser utilizado para o fim especificado depois do fim da perturbação. Eventualmente, a alimentação de corrente deve ser interrompida brevemente e o Controller iniciado novamente.
- **Disturbi elettromagnetici**
Se il Controller viene disturbato da influenze elettromagnetiche esterne, al termine del disturbo si può continuare a utilizzarlo senza problemi. Eventualmente si deve interrompere brevemente l'alimentazione elettrica e riavviare il Controller.
- **Электромагнитные помехи**
Если внешние электромагнитные воздействия создают помехи для работы контроллера, то после окончания действия этих помех он может работать по назначению дальше. Возможно потребуется на короткое время прервать подачу электропитания и перезапустить контроллер.
- **电磁干扰**
如果该控制器受到外部电磁影响的干扰，则可在干扰结束后按照规定继续使用。也有可能必须短时切断电源，然后重新启动控制器。

- Achtung! Verletzungsgefahr an Bauteilen mit funktionsbedingten scharfen Kanten und Spitzen!
- Caution! Be careful not to hurt yourself on components with sharp or pointed edges!
- Attention! Risque de blessure sur les éléments comportant des arêtes et o pointes vives indispensables au bon fonctionnement!
- Let op! U kunt zich bezeren aan bouwstenen met scherpe randen of punten!
- Attenzione! Esiste il pericolo di lesione con i pezzi di costruzione che hanno bordi e punte spigolosi necessari per la funzionalità del pezzo!
- Atenção! Perigo de ferimentos em peças componentes com cantos vivos e pontas obrigatórios para o funcionamento!
- Attenzione! Pericolo di lesioni dovute a componenti con spigoli vivi e punte per motivi funzionali!
- Будьте осторожны! Об острые края деталей и и наконечники можно порезаться!
- 注意！因功能需要而带有锋利的棱边和尖角的部件可能会带来受伤危险！

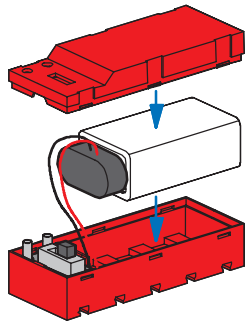

Batterie ist nicht Inhalt der Packung
 Battery not included
 Batterie non comprise
 De batterij wordt niet meegeleverd
 La batería no está incluida en el suministro
 A bateria não é o conteúdo da embalagem
 La batteria non è inclusa nella confezione
 Батарея в комплект не входит
 包装中不含电池

1 Batterie 9Volt-Block Alkaline oder 1 NiMH-Akku 9V

- Nicht wiederaufladbare Batterien dürfen nicht geladen werden
- Aufladbare Batterien dürfen nur von Erwachsenen geladen werden
- Aufladbare Batterien sind aus dem Batteriehalter herauszunehmen, bevor sie geladen werden.
- Batterien müssen mit der richtigen Polarität eingelegt werden.
- Leere Batterien müssen aus dem Spielzeug herausgenommen werden
- Die Anschlussklemmen dürfen nicht kurzgeschlossen werden.
- Verbrauchte Batterien dem Sondermüll zuführen.
- Drähte nicht in Steckdose einführen!
- Ladegerät regelmäßig auf Schäden überprüfen. Bei einem Schaden darf das Ladegerät bis zur vollständigen Reparatur nicht mehr verwendet werden.

9V rechargeable battery or 9 V alkaline dry cell

- Do not attempt to charge NON-rechargeable batteries.
- Rechargeable batteries are only to be charged by adults.
- Take rechargeable batteries out of the battery tray before charging them.
- Insert batteries with the correct polarity.
- Remove dead batteries from the toy.
- Do not short circuit the connecting terminals!
- Discard spent dry cells at special waste disposal centre.
- Do not insert the wires into an outlet!
- Regularly inspect battery charger for damage. If the battery charger has been damaged, it should not be used further until fully repaired.

pila 9V ou accu 9V

- Il est interdit de recharger des piles qui ne sont pas des accumulateurs
- Le chargement des accumulateurs doit toujours se faire par des adultes
- Retirer les accumulateurs du support de pile avant de les recharger.
- Veiller à la polarité correcte lors de la mise en place des piles.
- Retirer impérativement les piles ou accumulateurs vides du jouet.
- Il est interdit de court-circuiter les bornes de raccordement.
- Jeter les piles usagées dans un conteneur spécial réservé à cet effet.
- Ne pas introduire les fils dans une prise !
- Contrôlez régulièrement le chargeur en vue d'éventuelles détériorations
- En cas de détérioration, il est interdit d'utiliser le chargeur jusqu'à ce qu'il ait été intégralement réparé

alkaline batterij of oplaadbare batterij (9Volt)

- Niet-oplaadbare batterijen mogen niet worden opgeladen.
- Oplaadbare batterijen mogen uitsluitend door volwassenen worden opgeladen.
- Oplaadbare batterijen moeten uit de batterijhouder worden verwijderd, voordat deze worden opgeladen.
- De batterijen moeten met de juiste polariteit worden geplaatst.
- Lege batterijen moeten uit het speelgoed worden verwijderd.
- De aansluitklemmen mogen niet worden kortgesloten.
- Afleveren gebruikte batterijen bij het klein chemisch afval (KCA).
- Geen draden in de contactdoos steken!
- Laadtoestel regelmatig controleren op schade. Bij schade mag het laadtoestel niet meer gebruikt worden tot het volledig hersteld is.

pila alcalina bloque de 9 Voltios o acumulador NiMH- de 9 Voltios

- Las pilas no recargables no pueden ser cargadas
- Las pilas recargables sólo pueden ser cargadas por un adulto
- Las pilas recargables deben ser extraídas del compartimento de pilas antes de que sean cargadas.
- Las pilas deben ser colocadas con la polaridad correcta.
- Las pilas descargadas deben ser extraídas del juguete
- Os bornes de conexión no pueden ser puestos en cortocircuito.
- Retirar las baterías viejas, desechándolas en un depósito de basuras especiales.
- No introducir hilos en la toma de corriente!
- Comprobar con regularidad si el cargador presenta daños. En caso de presentar daños, el cargador no debe volver a ser utilizado hasta que esté completamente reparado.

Bateria alcalina de bloco de 9 V ou acumulador NiMH- de 9 V

- Pilhas não recarregáveis não devem ser novamente carregadas.
- Pilhas recarregáveis somente devem ser recarregadas por adultos.
- Pilhas recarregáveis devem ser retiradas do compartimento de pilhas antes de serem carregadas.
- As pilhas devem ser colocadas com a polaridade correta.
- As pilhas descarregadas devem ser retiradas do brinquedo.
- Os terminais de conexão não devem ser curto-circuitados.
- Eliminar as baterias esgotadas como desperdício perigoso
- Nunca introduzir fios na tomada!
- Verificar regularmente se o carregador apresenta danos. Em caso de dano, o carregador não deverá ser utilizado enquanto não estiver plenamente consertado.

1 batteria alcalina da 9 V o 1 batteria NiMH- ricaricabile da 9V

- Le batterie non ricaricabili non devono essere ricaricate
- Le batterie ricaricabili devono essere ricaricate da persone adulte
- Le batterie ricaricabili si devono estrarre dal supporto prima di ricaricarle.
- Le batterie usate negli appositi contenitori per la raccolta differenziata.
- Non inserire i fili nella presa elettrica.
- Controllare periodicamente se il caricabatterie presenta dei danni. In caso di danni, il caricabatterie non deve più essere utilizzato fino alla riparazione.

1 алкалиновая батарейка на 9 В или 1 никель-кадмиевый аккумулятор, 9 В

- Не пытайтесь заряжать перезаряжаемые батарейки.
- Зарядку перезаряжаемых аккумуляторов разрешается выполнять только взрослым.
- Перед зарядкой перезаряжаемых аккумуляторов извлеките их из аккумуляторного отсека.
- При установке аккумуляторов на место соблюдайте полярность.
- Разряженные батарейки необходимо извлечь из игрушки.
- Не замыкайте коротко соединительные клеммы.
- Использованные батареи утилизировать как спецотходы.
- Не вставляйте в розетку провода!
- Регулярно проверяйте зарядное устройство на отсутствие повреждений. При наличии повреждений использовать зарядное устройство до выполнения его полного ремонта не разрешается.

1 个 9V 的碱性方电池或 1 个 9V 的 NiMH- 蓄电池

- 不得给非充电电池充电
- 只允许由成年人给充电电池充电
- 在充电前必须将充电电池从电池夹中取出。
- 必须按照正负极正确放入电池。
- 必须从玩具中取出没有电的电池
- 接线柱不允许被短路。
- 用完了的电池应作为特种垃圾处理。
- 禁止将金属丝插入插座！
- 经常检查充电器是否有损坏情况。如果充电器有损，直到完全修好为止不可以再使用。

EU-Konformitätserklärung:

Hiermit erklärt die fischertechnik GmbH, dass der „BT Smart Controller, Art.-Nr. 161944“ der Richtlinie 2014/53/EU entspricht. Der vollständige Text der EU-Konformitätserklärung ist unter der folgenden Internetadresse verfügbar: www.fischertechnik.de/BT-Smart-Controller

EU Declaration of Conformity:

fischertechnik GmbH hereby declares that the „BT Smart Controller, item no.161944“ complies with Directive 2014/53/EU. The complete text for the EU Declaration of Conformity can be found at the following Internet address: www.fischertechnik.de/BT-Smart-Controller

Déclaration de conformité européenne :

La société fischertechnik GmbH déclare par la présente que le « BT Smart Controller, art. n° 161944 » est conforme à la directive 2014/53/CEE. Vous trouverez le texte intégral de la déclaration de conformité européenne sur Internet à l'adresse suivante : www.fischertechnik.de/BT-Smart-Controller

EU-conformiteitsverklaring:

Hiermee verklaart de fischertechnik GmbH, dat de „BT Smart Controller, art.-nr. 161944“ aan de richtlijn 2014/53/EU voldoet. De volledige tekst van de EU-conformiteitsverklaring is op het volgende internetadres beschikbaar: www.fischertechnik.de/BT-Smart-Controller

Declaración UE de conformidad:

Por la presente, fischertechnik GmbH declara que el „BT Smart Controller, núm. de art. 161944“ cumple la directiva 2014/53/UE. El texto integral de la declaración UE de conformidad está disponible en la dirección de Internet siguiente: www.fischertechnik.de/BT-Smart-Controller

Declaração de conformidade da CE:

Por essa, a fischertechnik GmbH declara que o „BT Smart Controller, art.no. 161944“ corresponde à Diretiva 2014/53/CE. O texto completo da declaração de conformidade da CE está disponível no seguinte endereço da Internet: www.fischertechnik.de/BT-Smart-Controller

Dichiarazione di conformità UE:

con la presente la fischertechnik GmbH dichiara che il „BT Smart Controller, num. art. 161944“ è conforme alla direttiva 2014/53/UE. Il testo completo della dichiarazione di conformità è disponibile al seguente indirizzo Internet: www.fischertechnik.de/BT-Smart-Controller

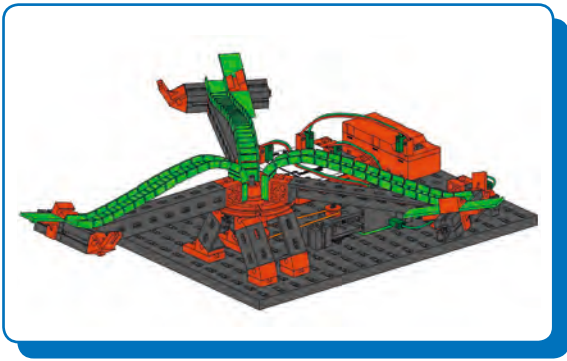

Karussell
Merry-go-round
Manège

Draaimolen
Tiovivo
Carrossel

Giostra
Карусель
旋转木马

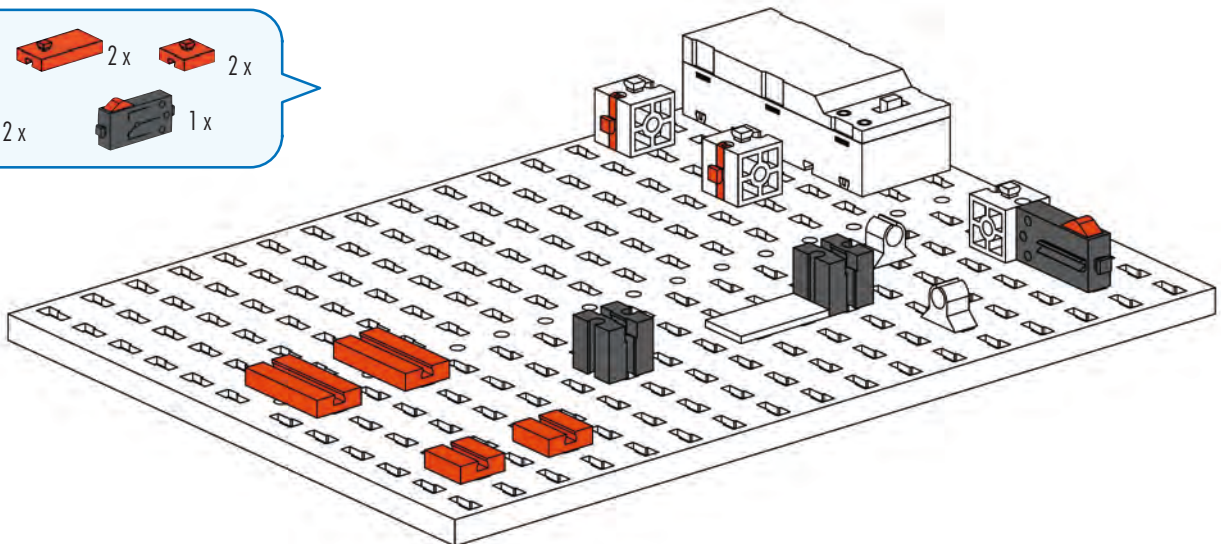
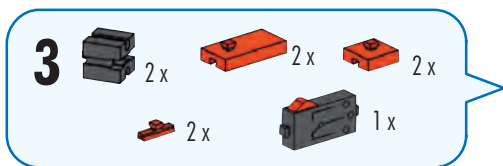
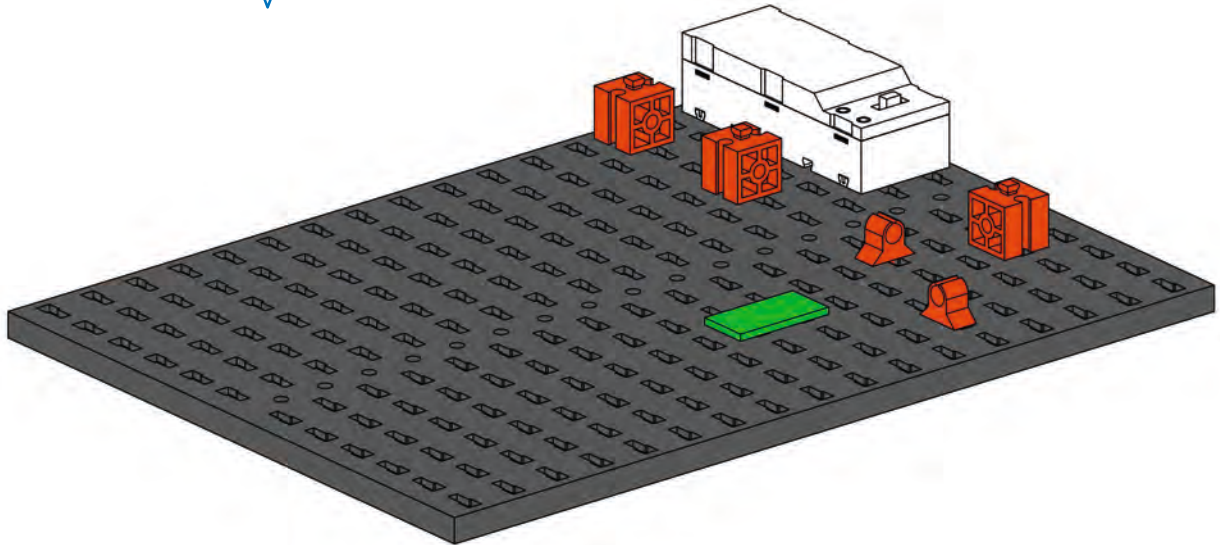
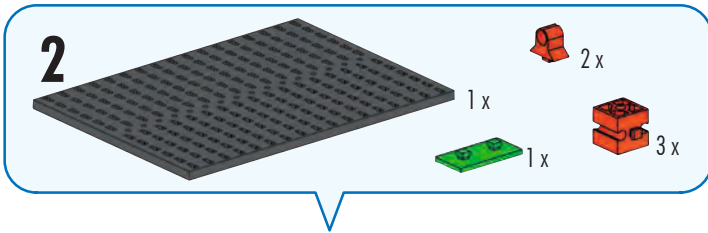
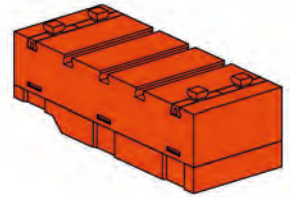
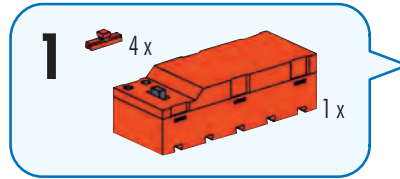

4

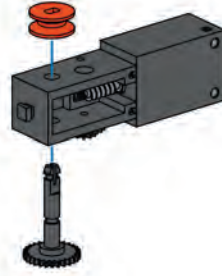

5

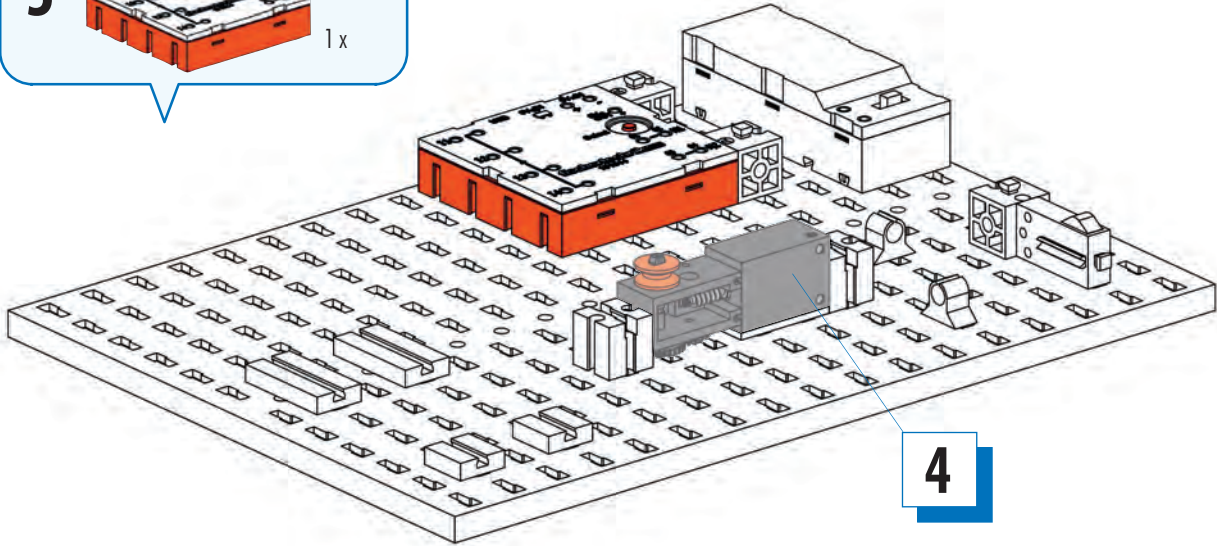
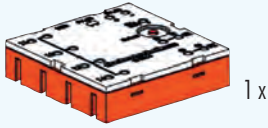

4



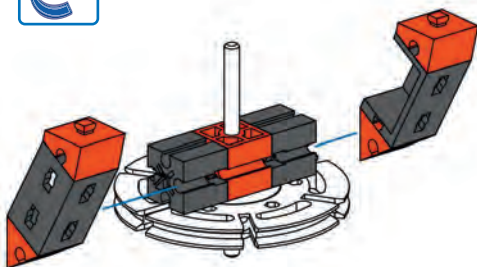
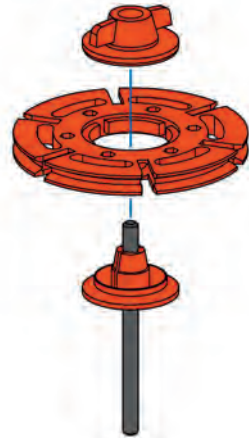
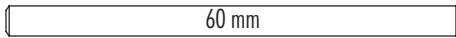

6

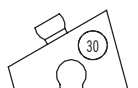
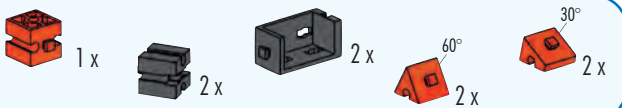

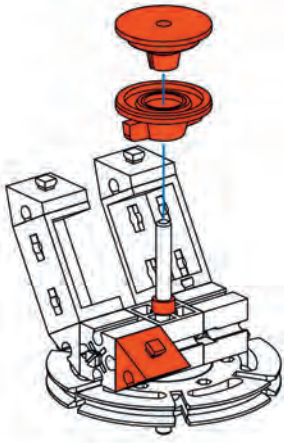



7







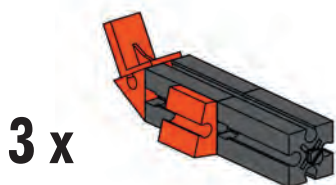
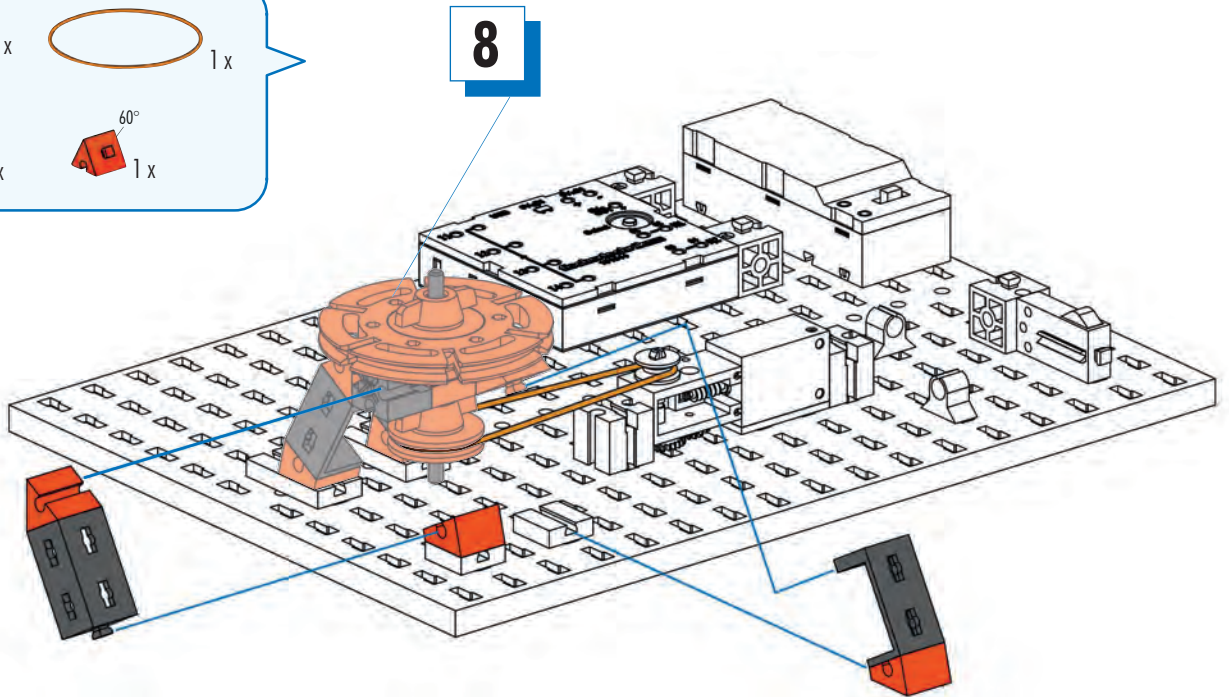
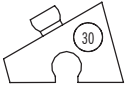

8  1x  1x  1x  60° 1x

9  2x  1x
 30° 2x  60° 1x



10  6x  3x  60° 3x  15° 3x

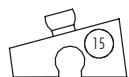

11

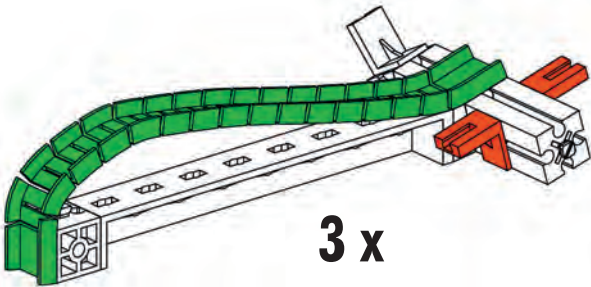
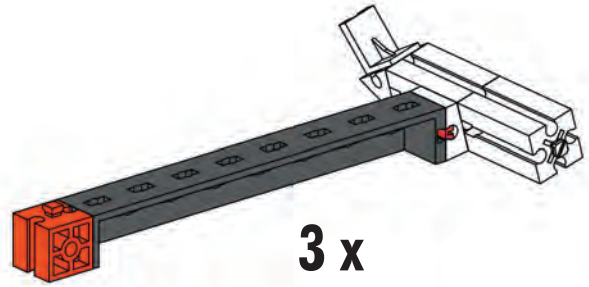
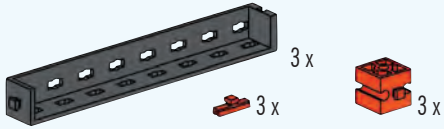

12

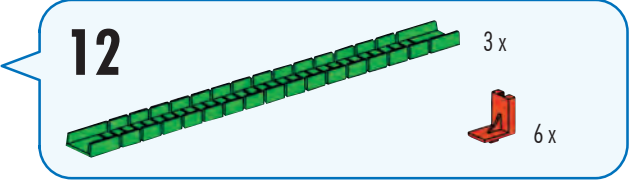
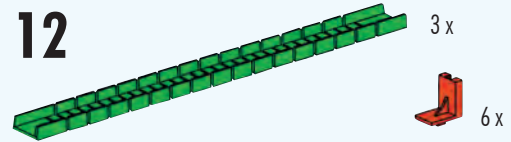

13

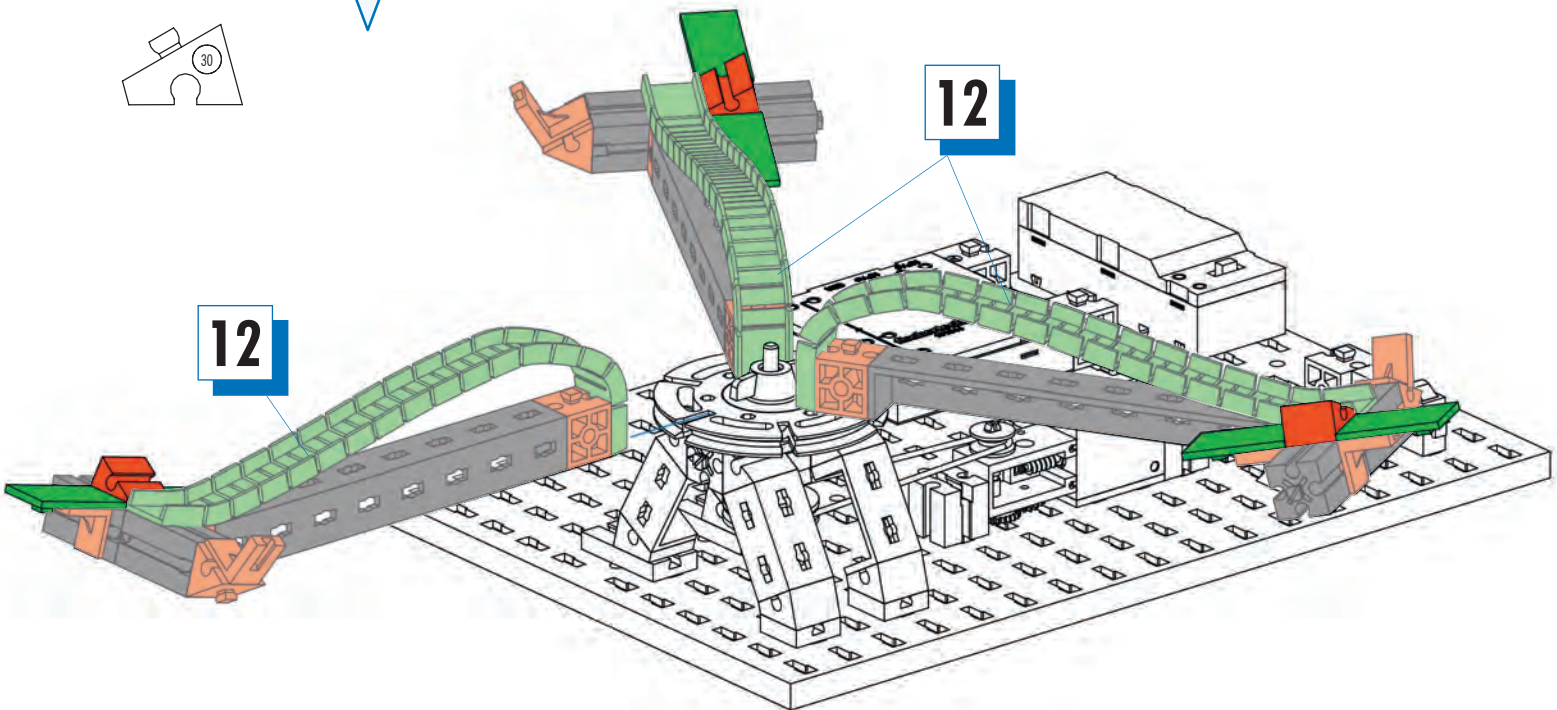
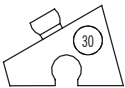

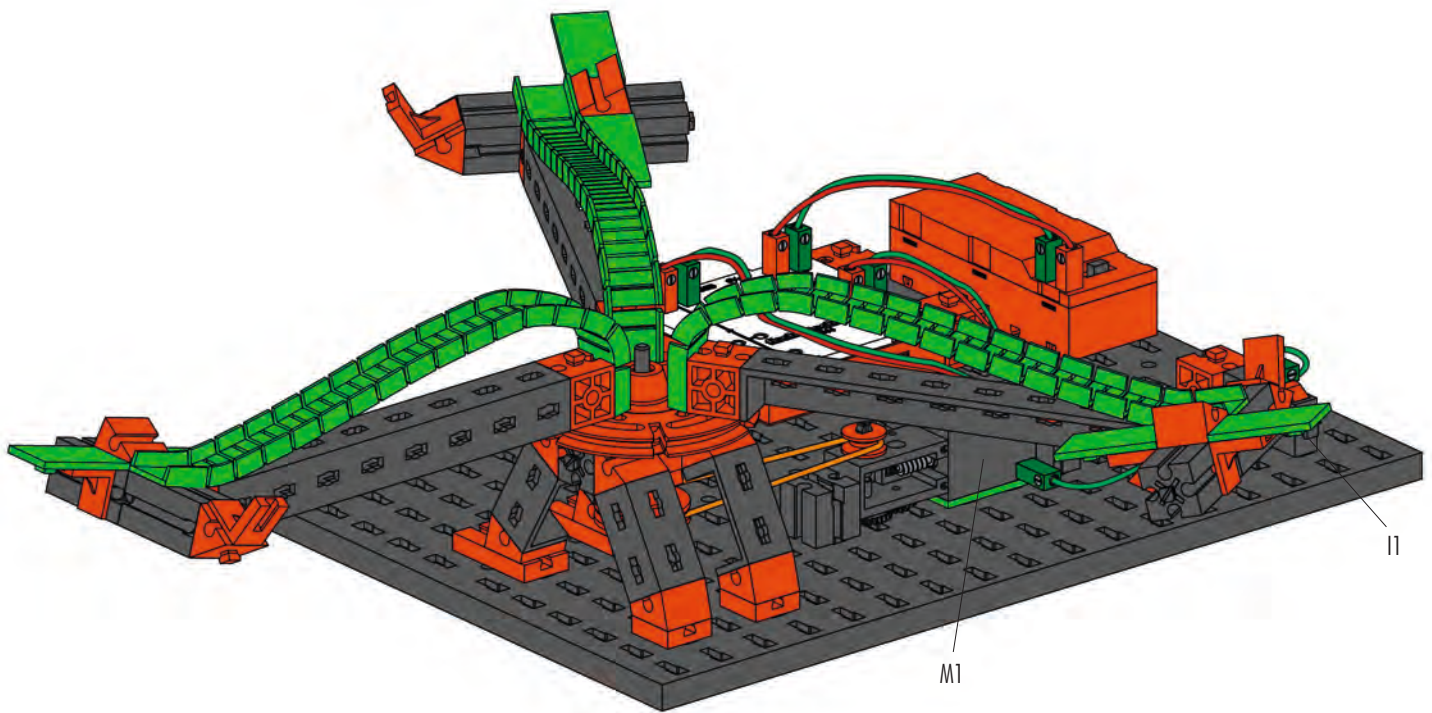

Schaltplan
Circuit diagram
Plan électrique

Schakelschema
Diagrama de circuitos
Plano elétrico de ligação

Schema elettrico
Схема подключения
电路图

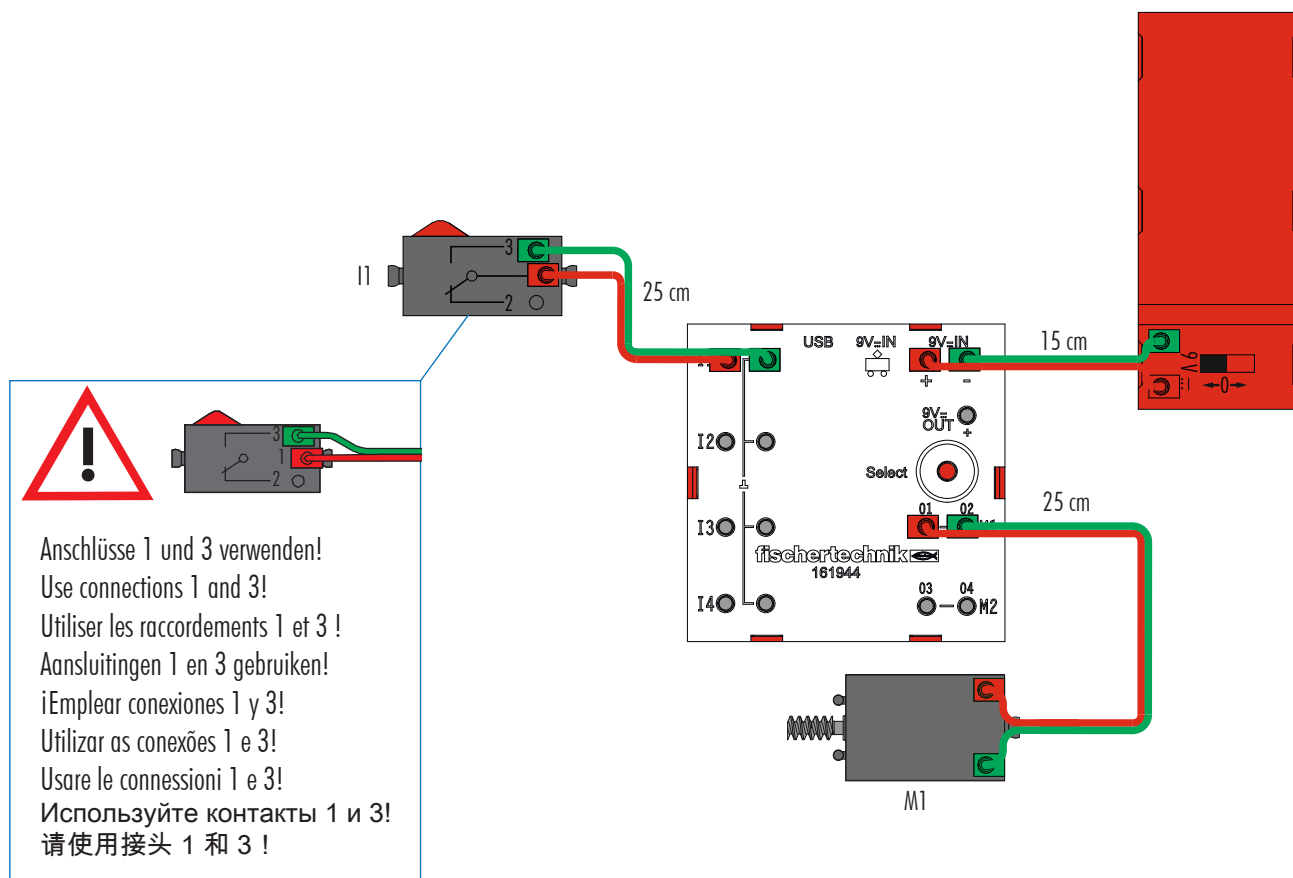

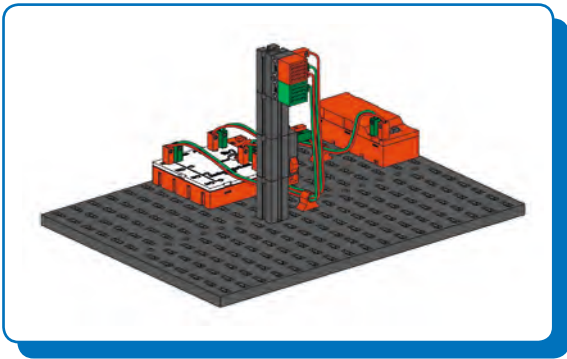

Fußgängerampel
Pedestrian light
Feu de signalisation
pour piétons

Voetgangersstoplicht
Semáforo para peatones
Semáforo para
pedestres

Semaforo pedonale
Светофор для
пешеходов
行人交通信号灯

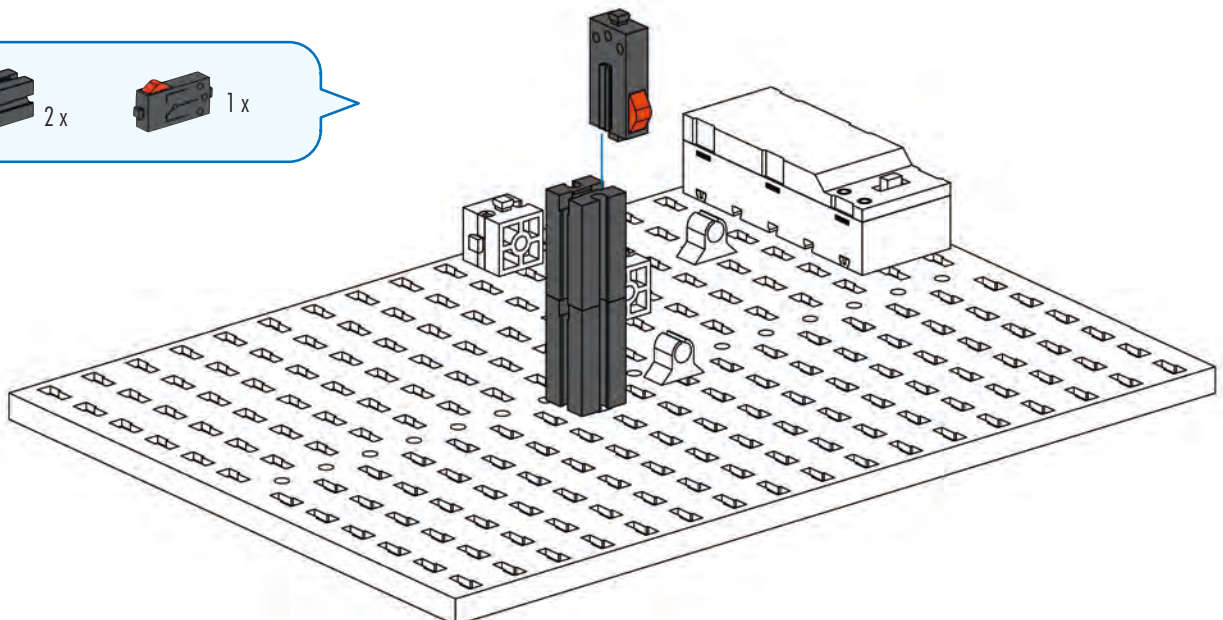
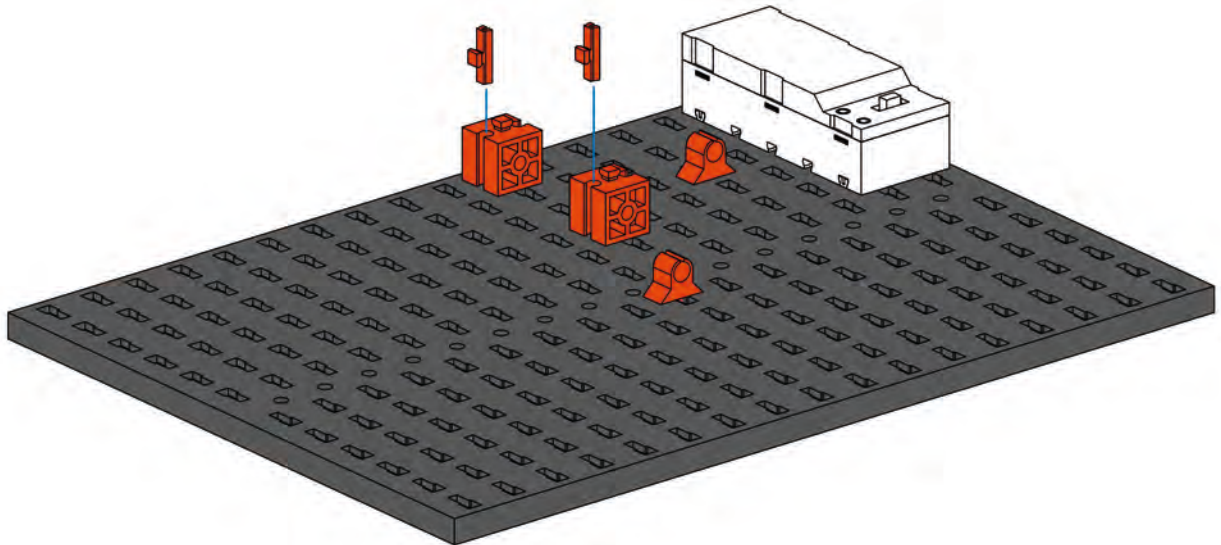
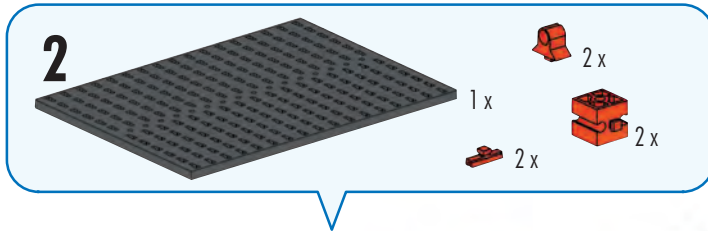
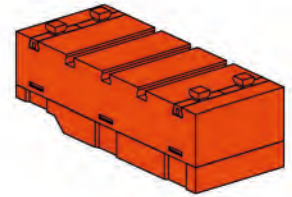
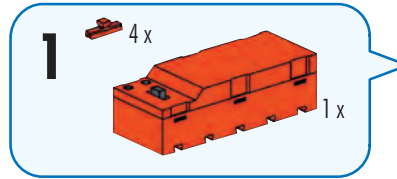

4

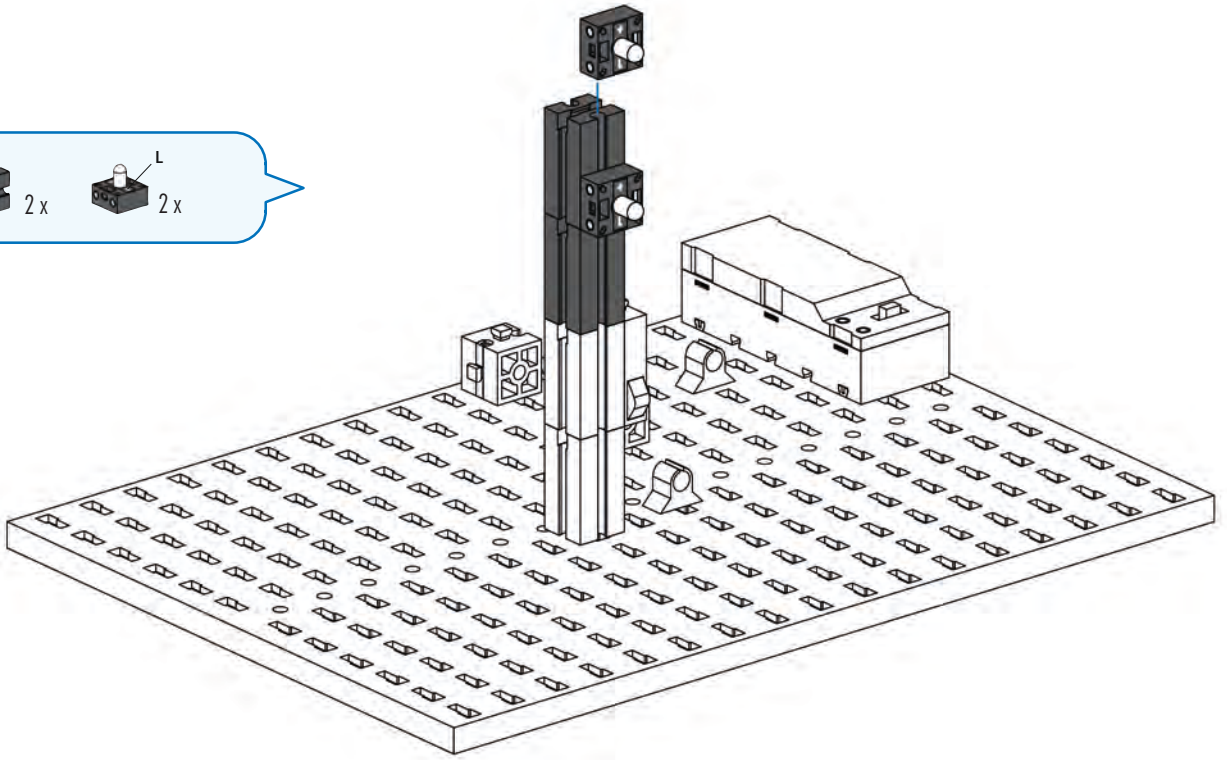
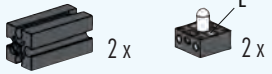

5

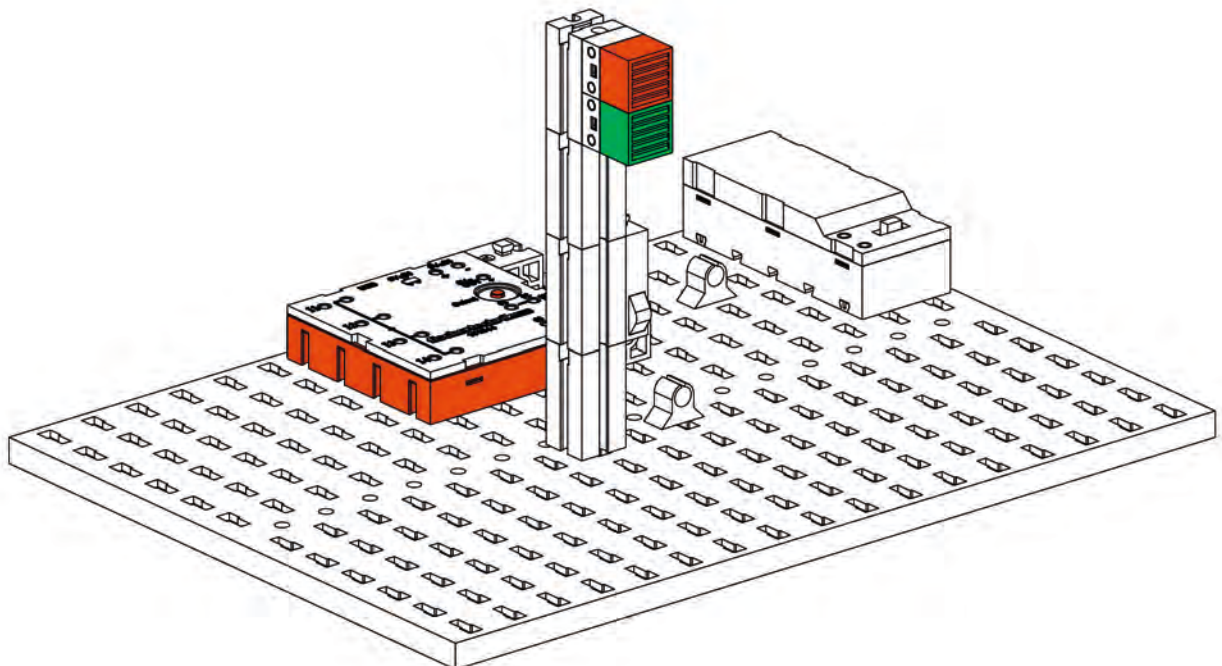
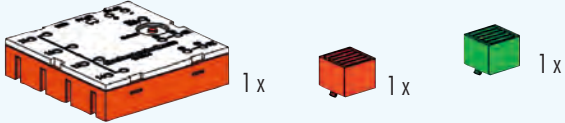

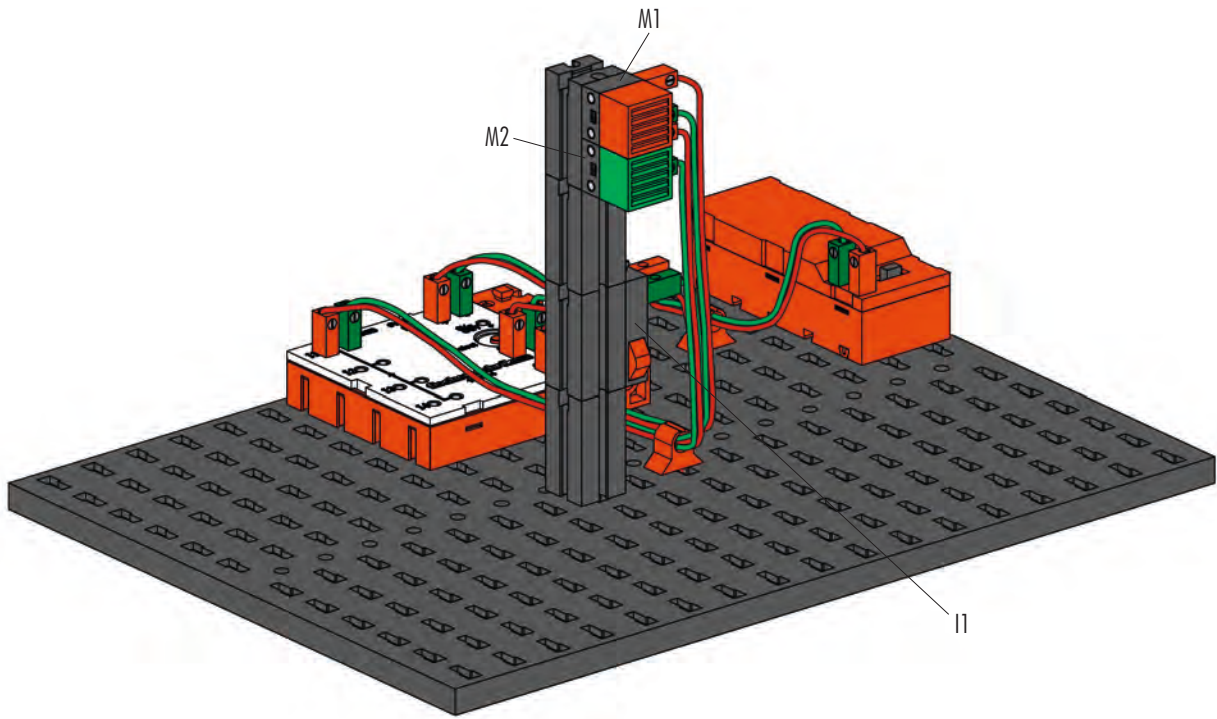

Schaltplan
Circuit diagram
Plan électrique

Schakelschema
Diagrama de circuitos
Plano elétrico de ligação

Schema elettrico
Схема подключения
电路图

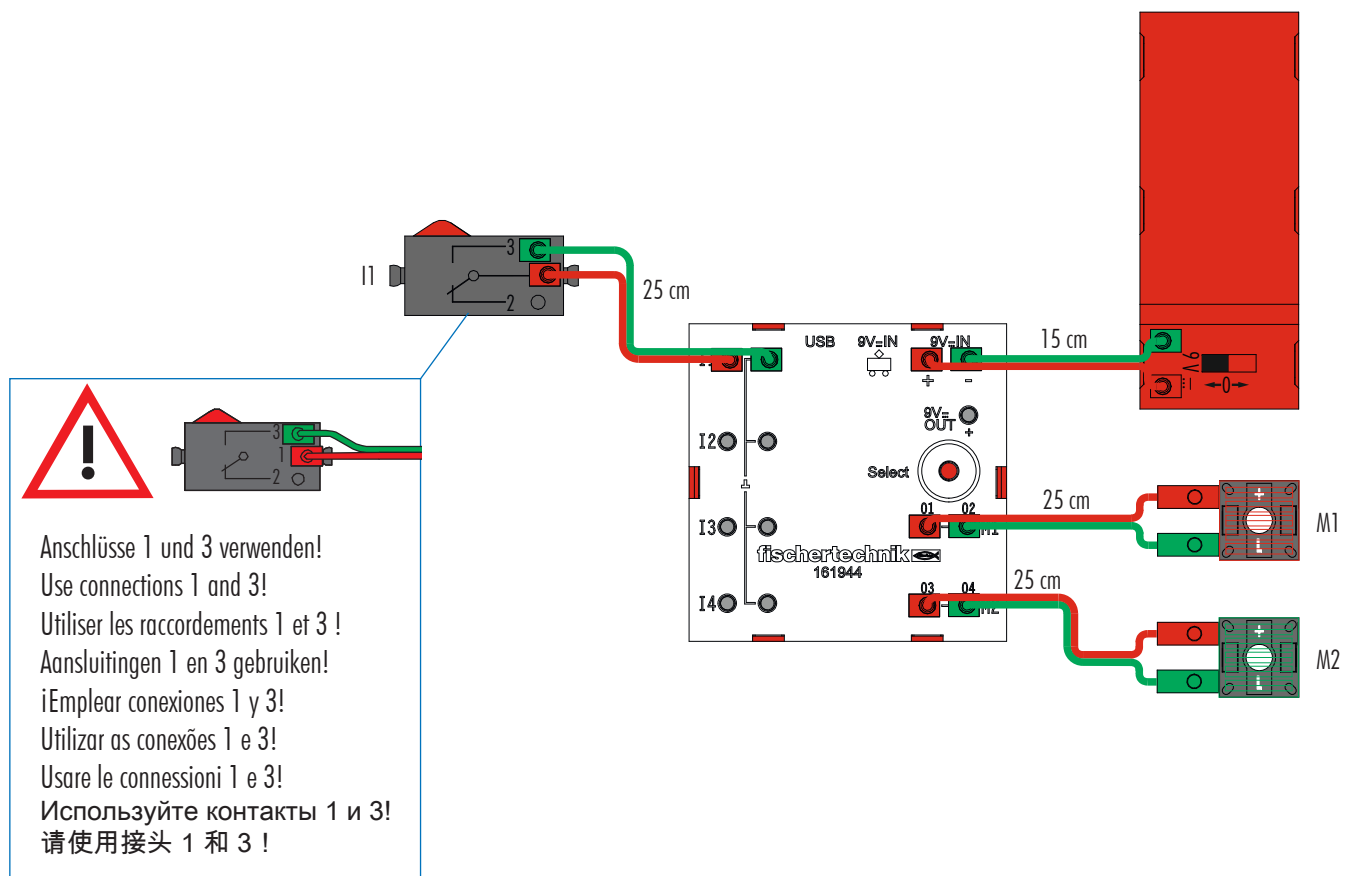

Leuchtturm mit Blinklicht
Lighthouse with
blinking light
Phare à feu clignotant

Vuurtoren met knipperlicht
Faro con luz intermitente
Torre de iluminação com
luz intermitente

Faro con luce
lampeggiante
Маяк с мигающим светом
带闪光信号灯的灯塔

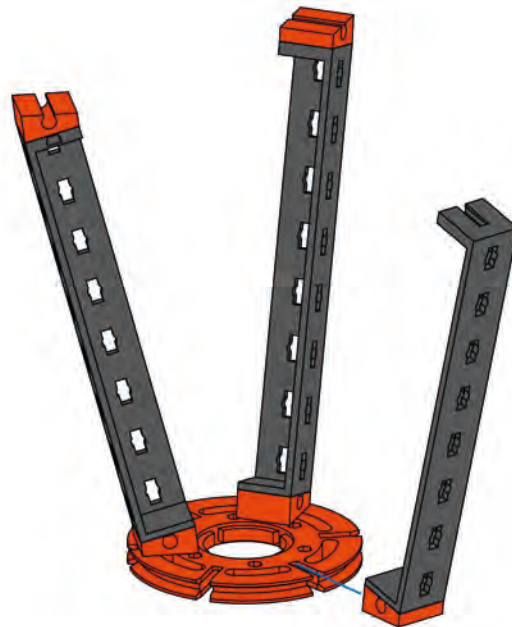
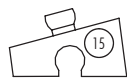
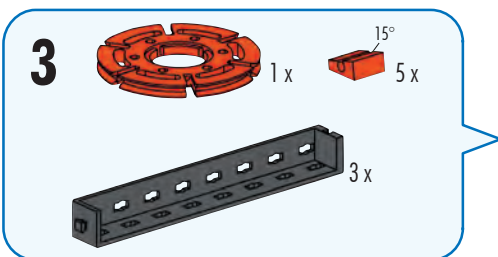
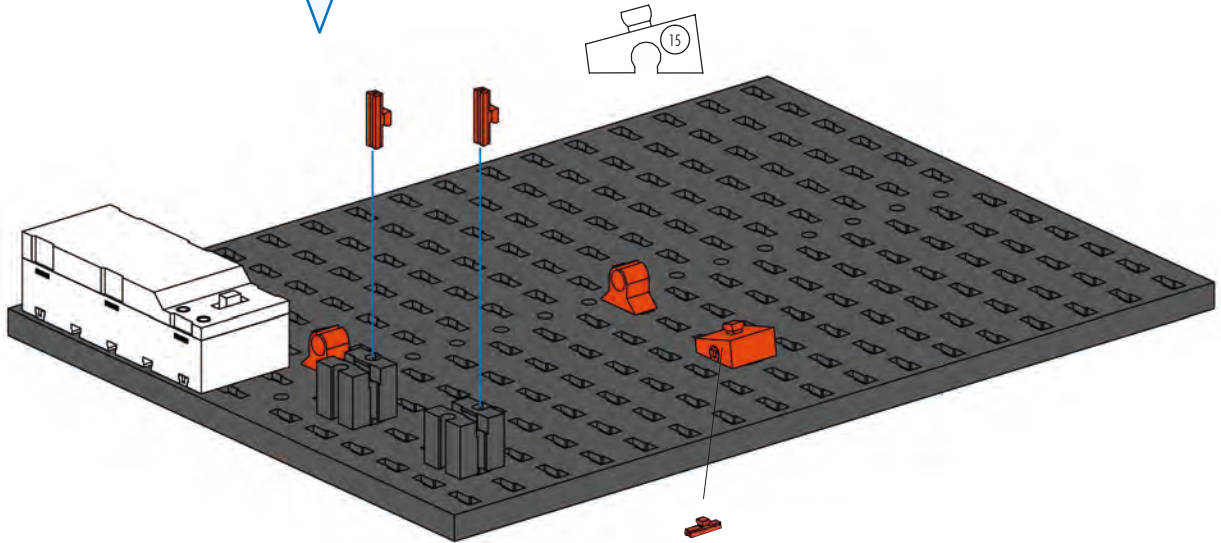
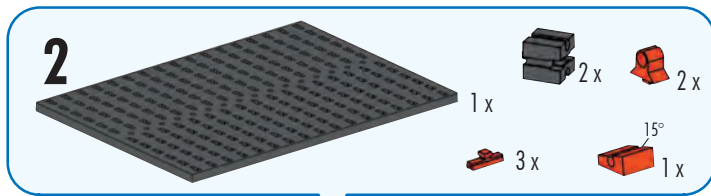
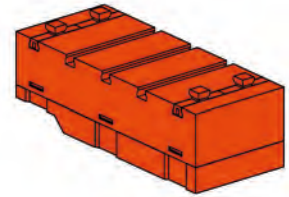
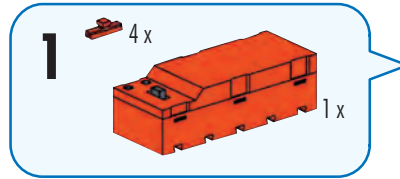

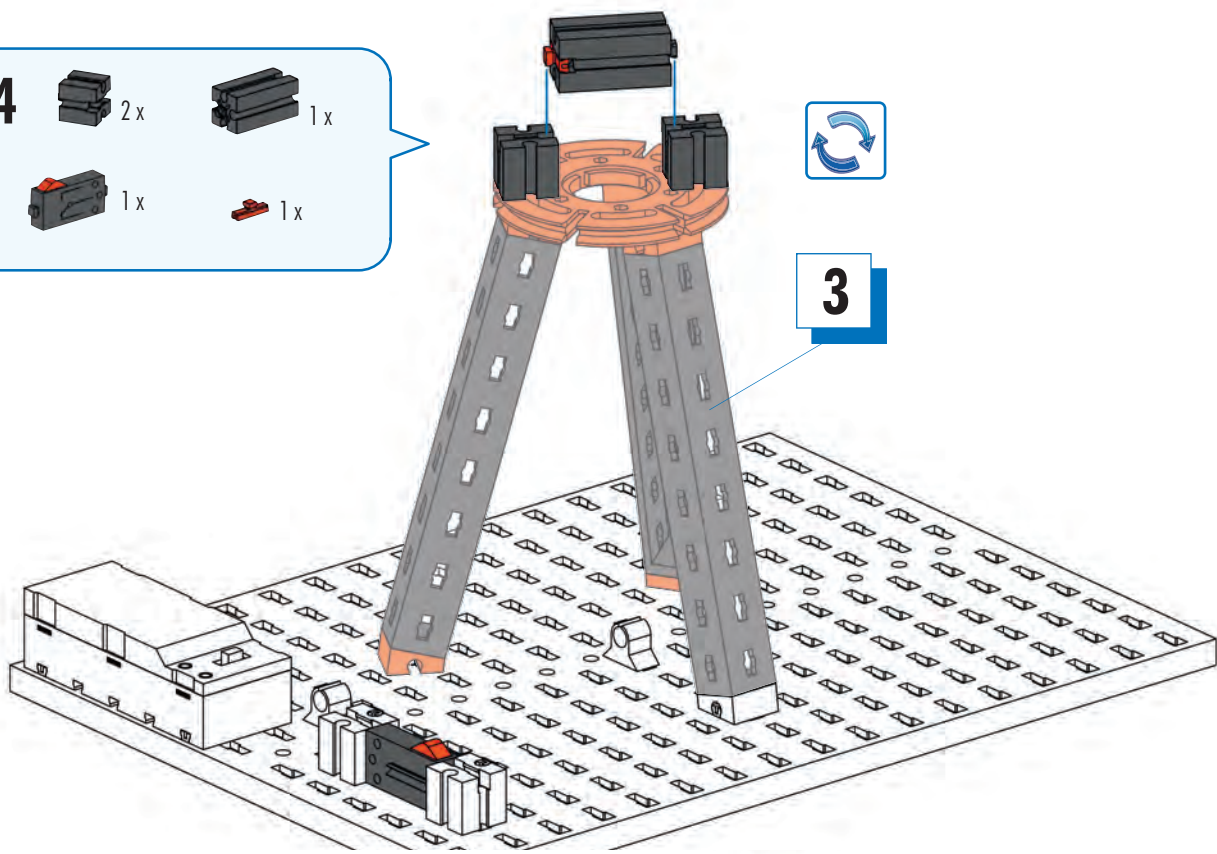

- 4**
- 2x [Black 1x3 Technic Pin]
 - 1x [Black 1x3 Technic Pin]
 - 1x [Black 1x3 Technic Pin]
 - 1x [Red 1x3 Technic Pin]

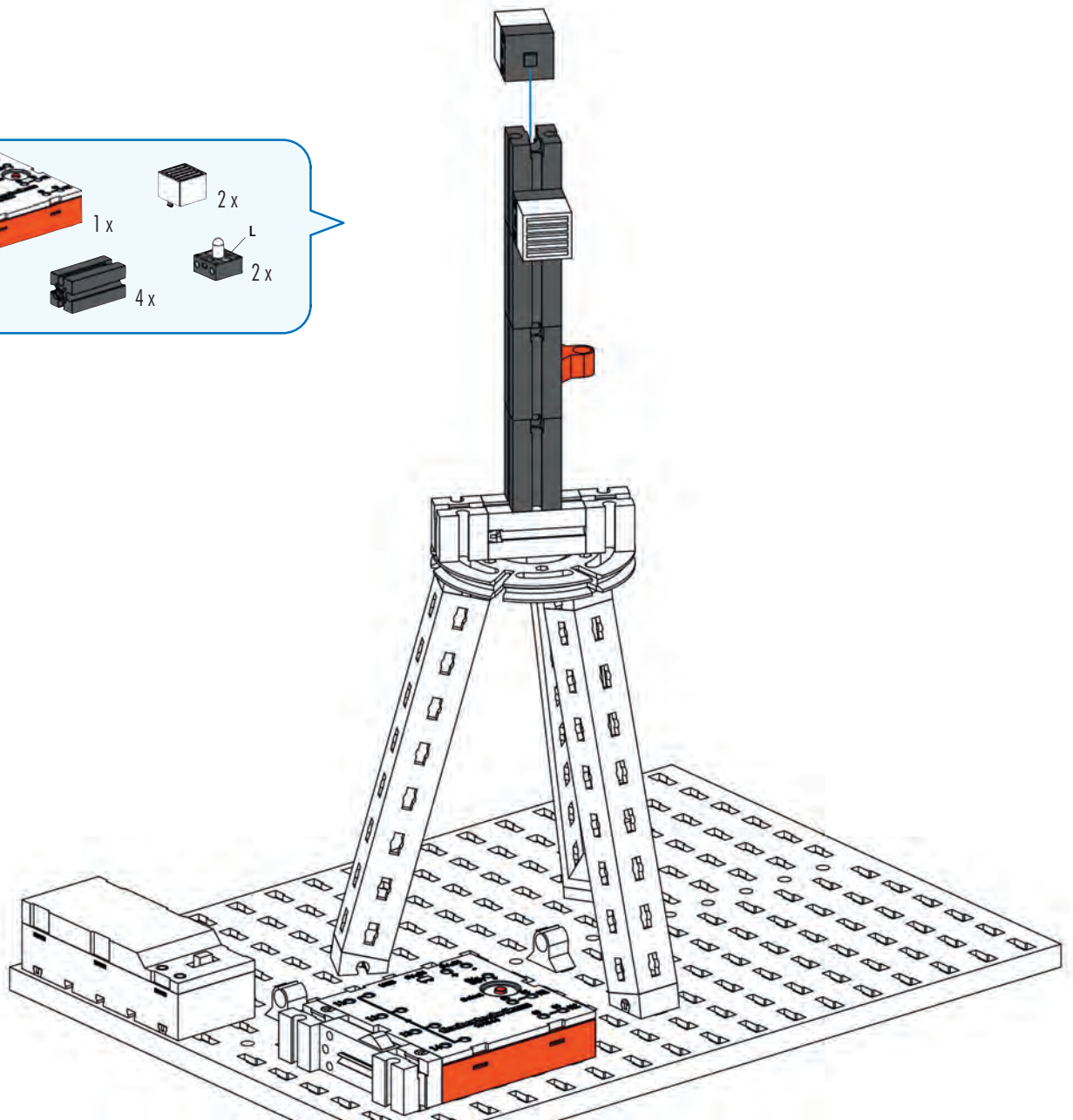

- 5**
- 1x [Red and Black 1x10 Technic Plate]
 - 2x [White 1x1 Technic Pin]
 - 1x [Red 1x1 Technic Pin]
 - 4x [Black 1x3 Technic Pin]
 - 2x [Black 1x1 Technic Pin with L-shaped notch]

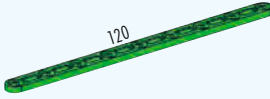

6  15° 2 x  120 2 x  4 x

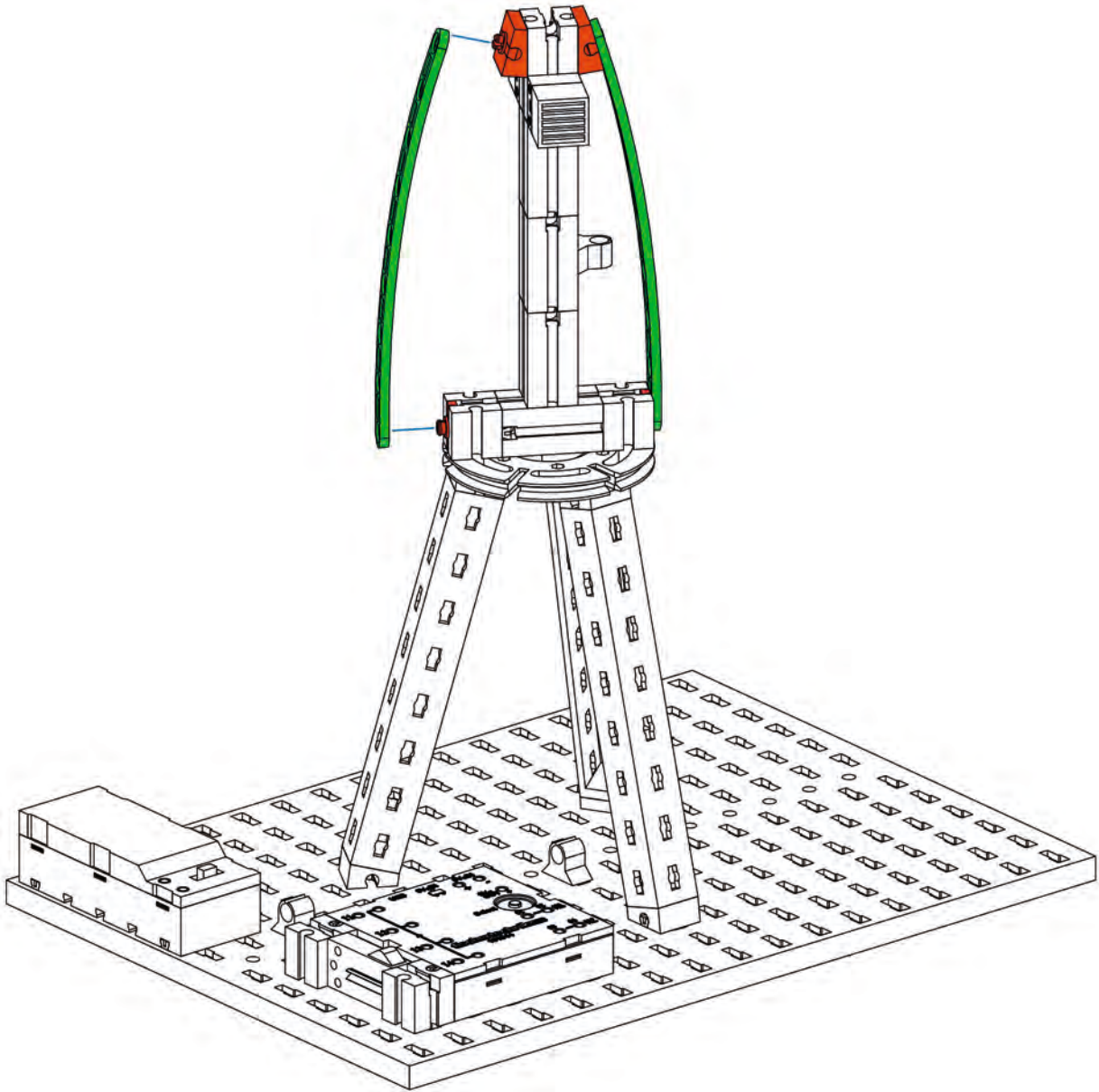

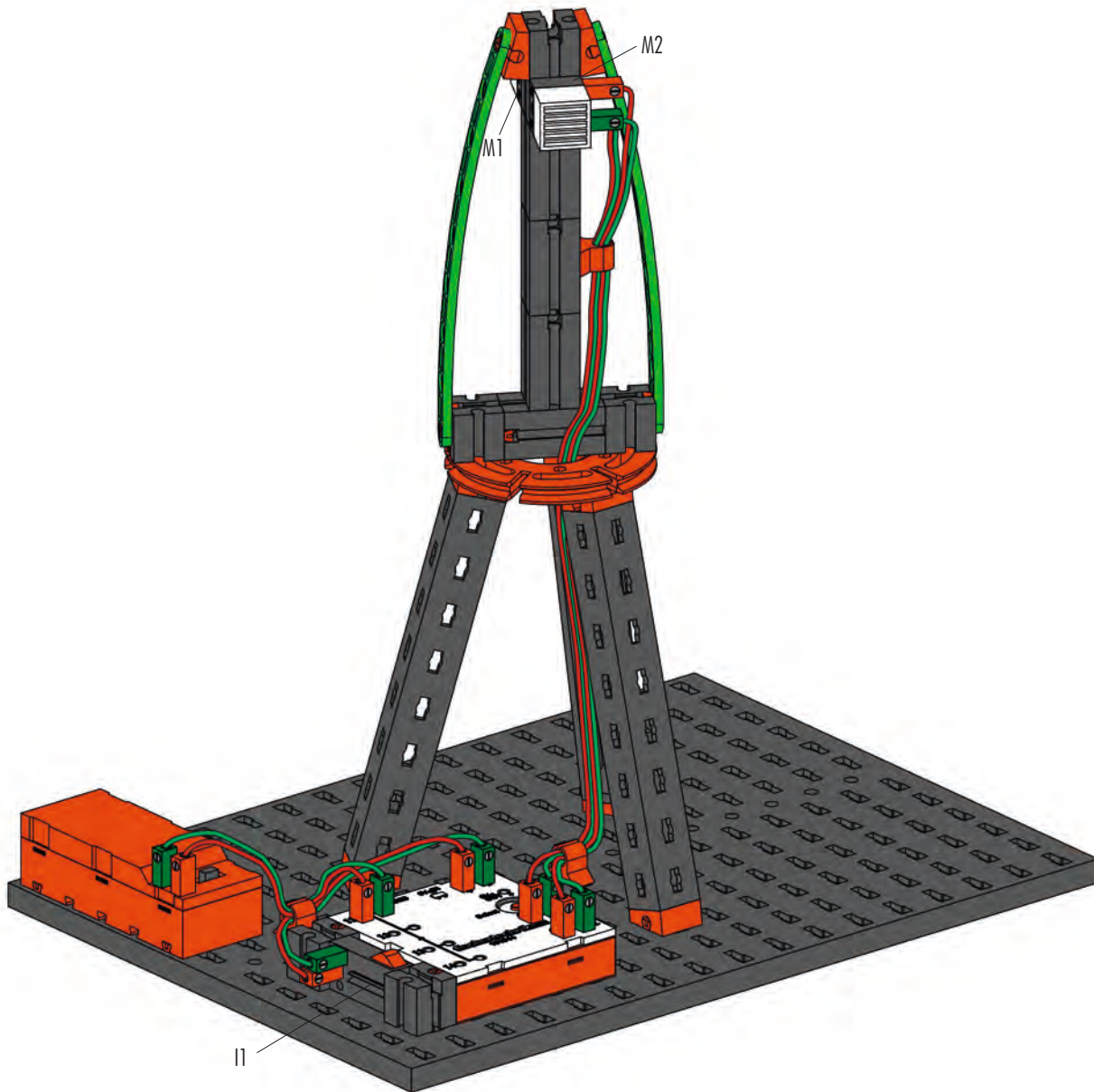

Schaltplan
Circuit diagram
Plan électrique

Schakelschema
Diagrama de circuitos
Plano elétrico de ligação

Schema elettrico
Схема подключения
电路图

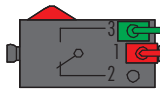
Anschlüsse 1 und 3 verwenden!
Use connections 1 and 3!
Utiliser les raccordements 1 et 3!
Aansluitingen 1 en 3 gebruiken!
iEmplear conexiones 1 y 3!
Utilizar as conexões 1 e 3!
Usare le connessioni 1 e 3!
Используйте контакты 1 и 3!
请使用接头 1 和 3!



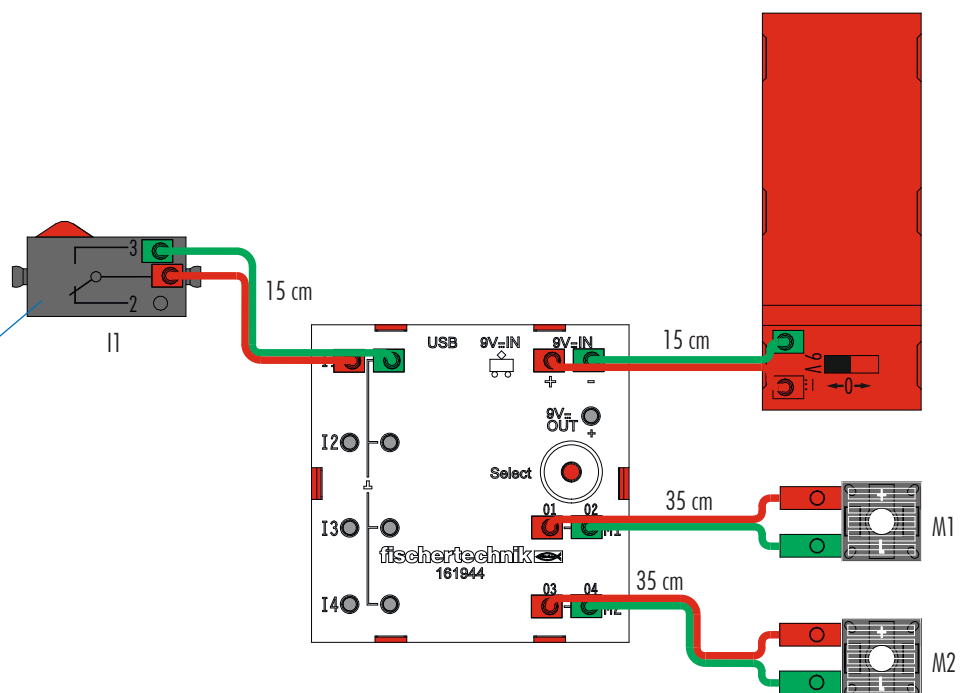

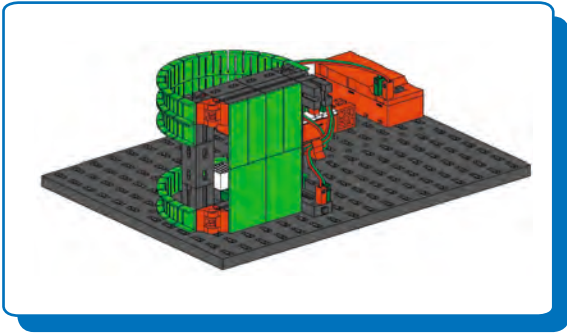
Kühlschrank
Refrigerator
Réfrigérateur

Koelkast
Nevera
Refrigerador

Frigorifero
Холодильник
冰箱

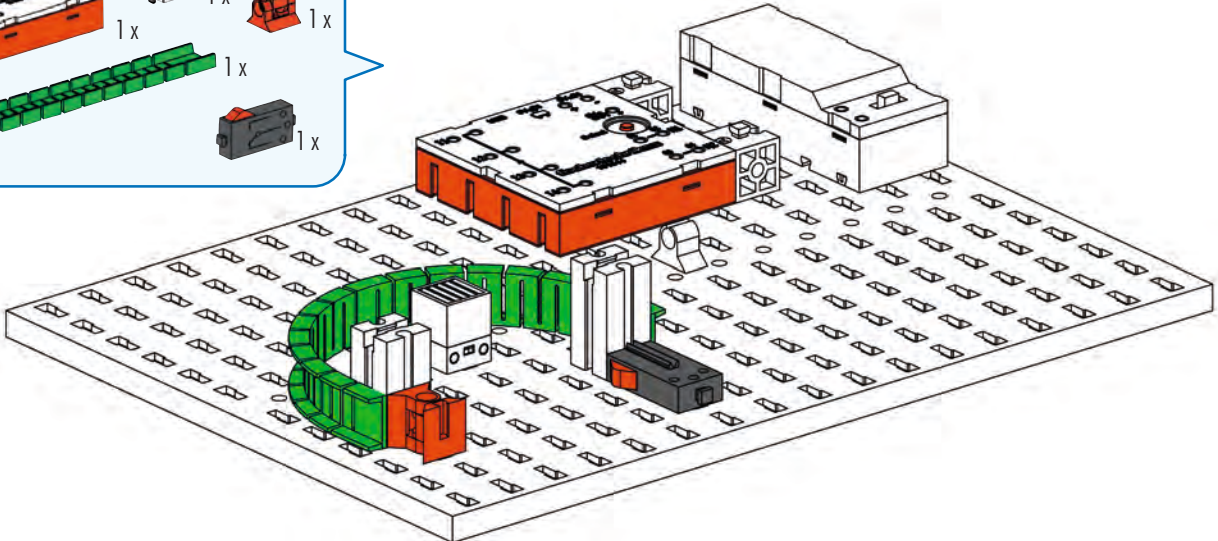
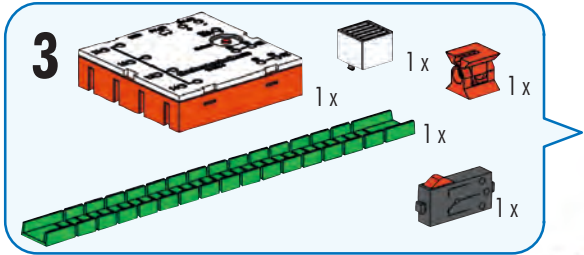
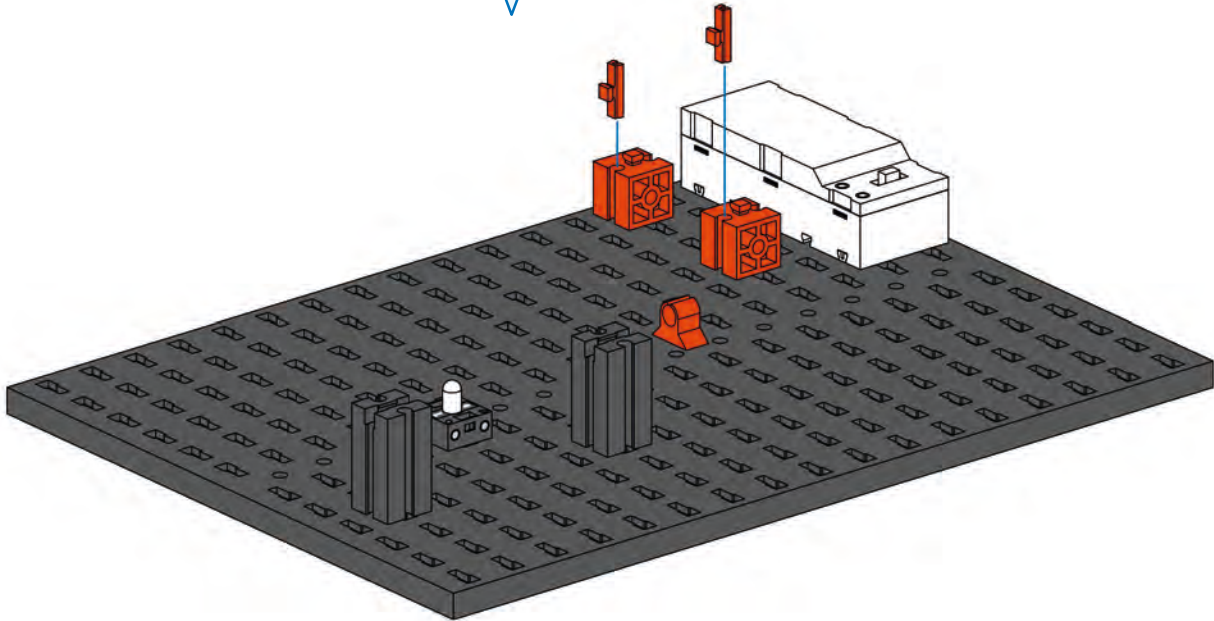
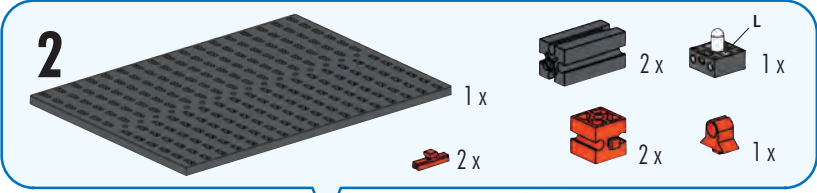
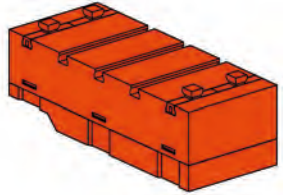
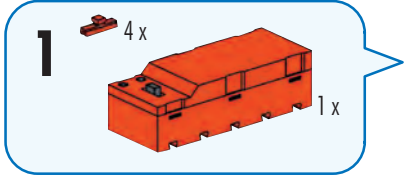

4

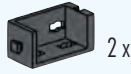

2x



1x



2x

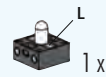

1x

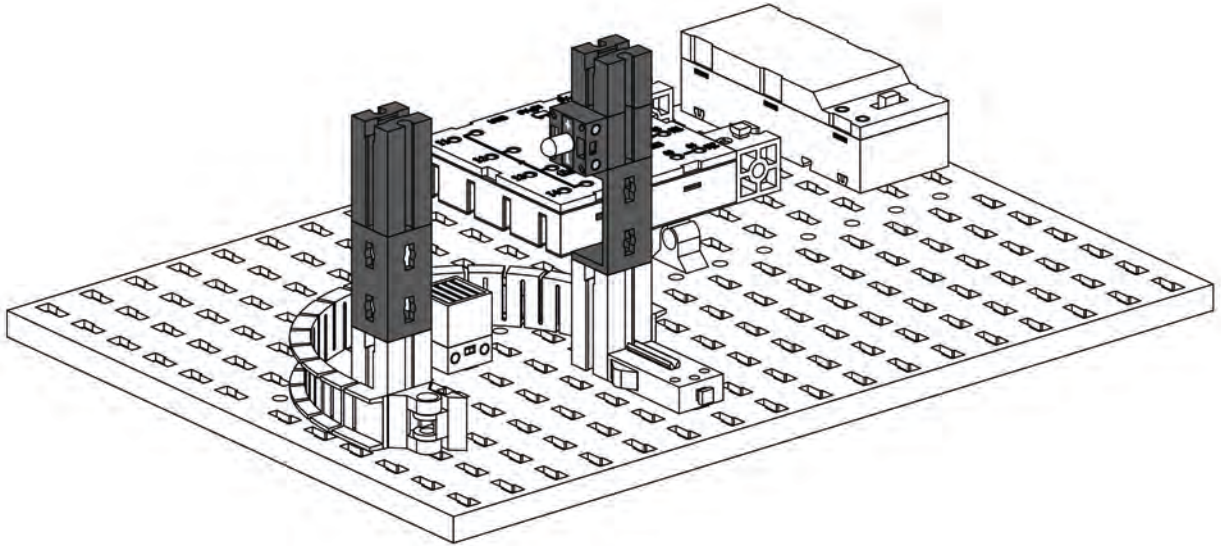

5

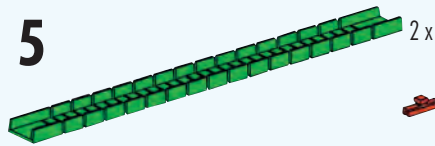

2x



1x

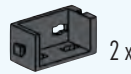

2x



1x

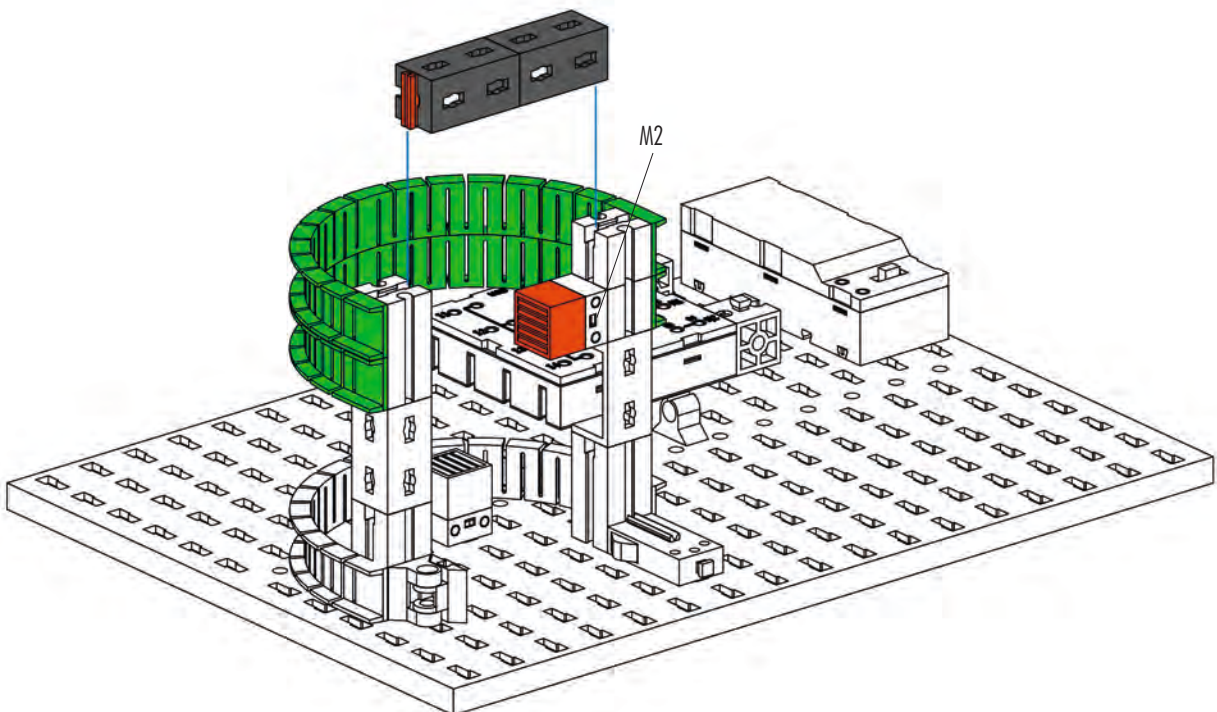

6

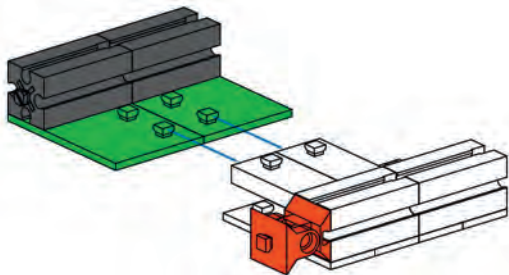
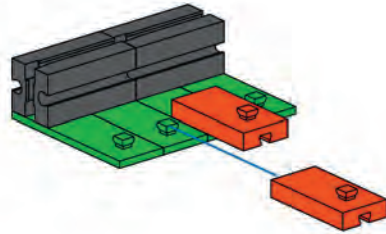
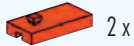
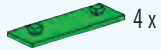
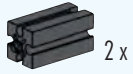

7

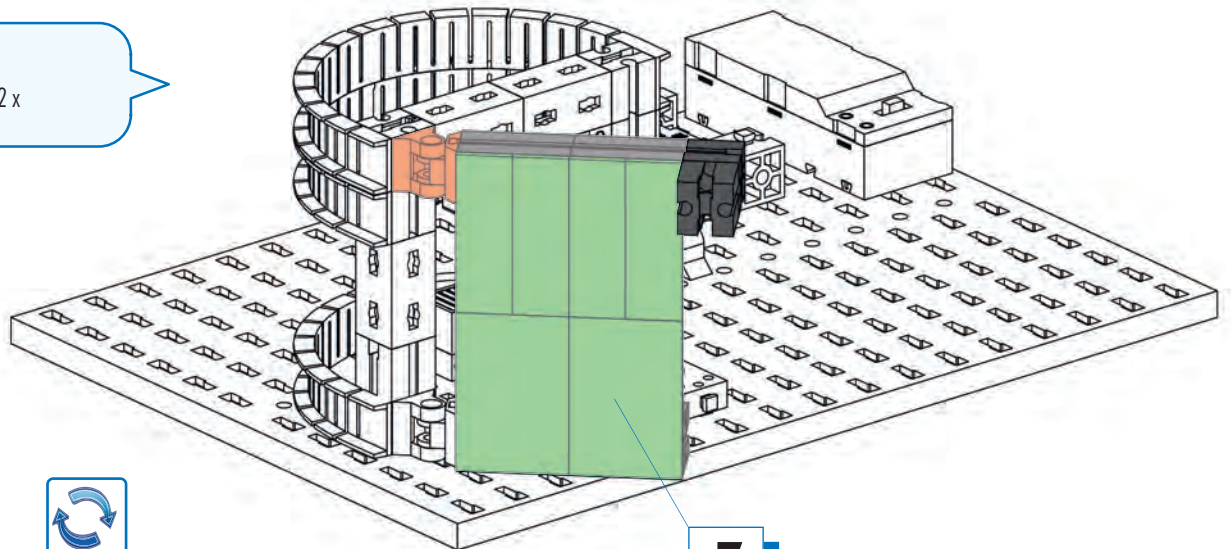
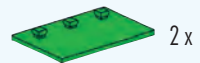
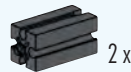

8



7

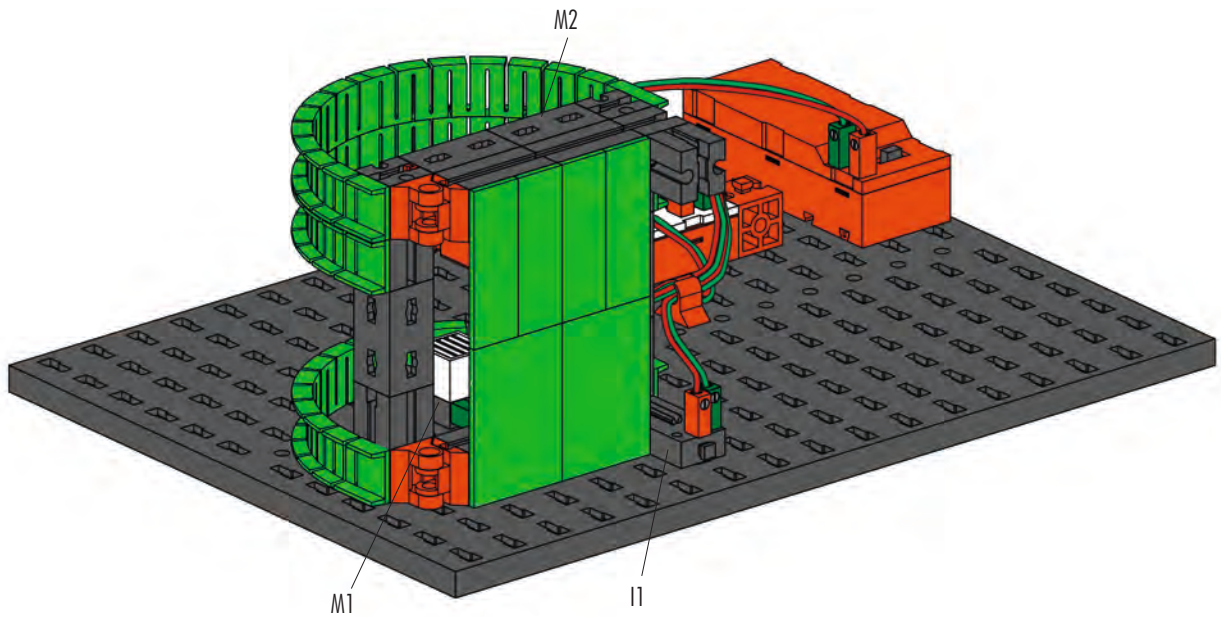

Schaltplan
Circuit diagram
Plan électrique

Schakelschema
Diagrama de circuitos
Plano elétrico de ligação

Schema elettrico
Схема подключения
电路图

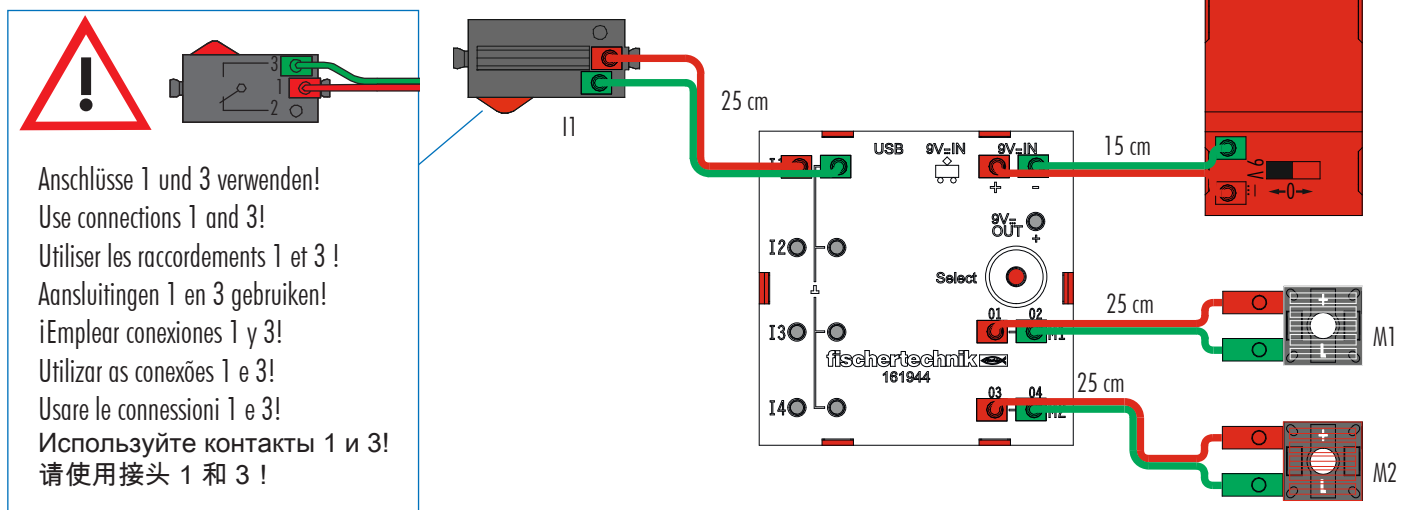

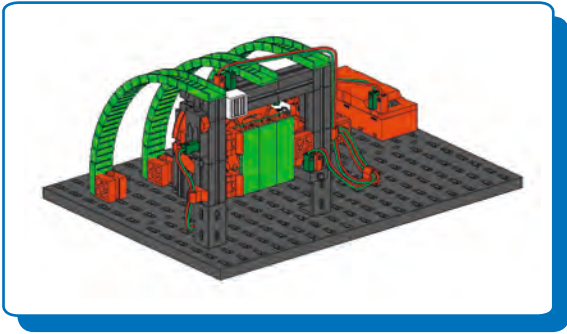





Waschmaschine
Washing machine
Lave-linge

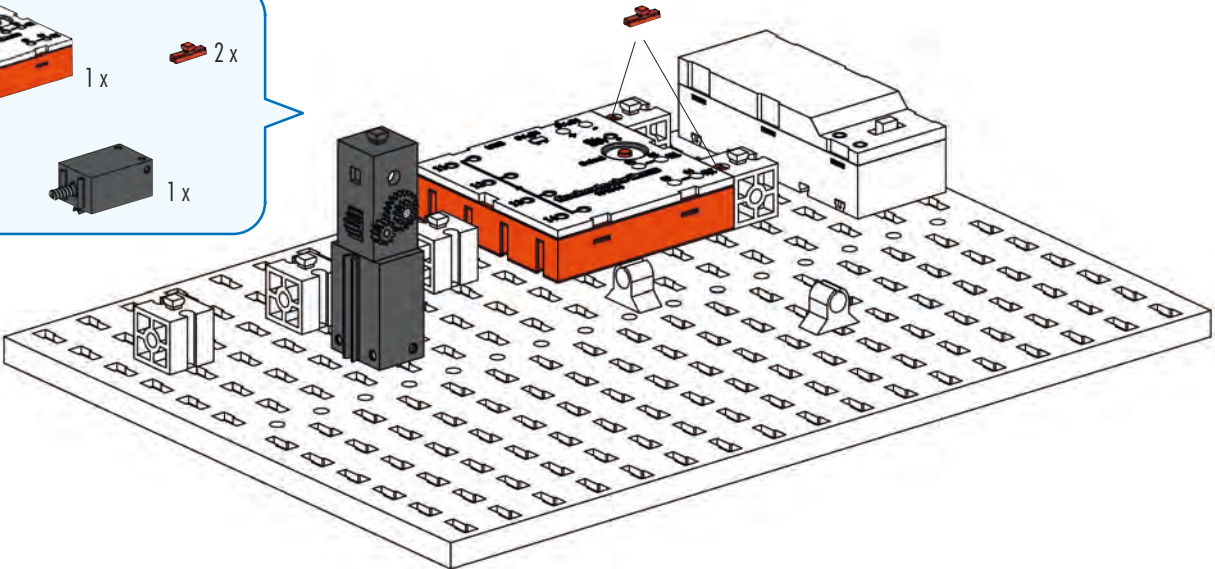
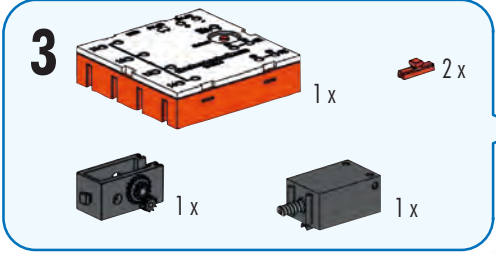
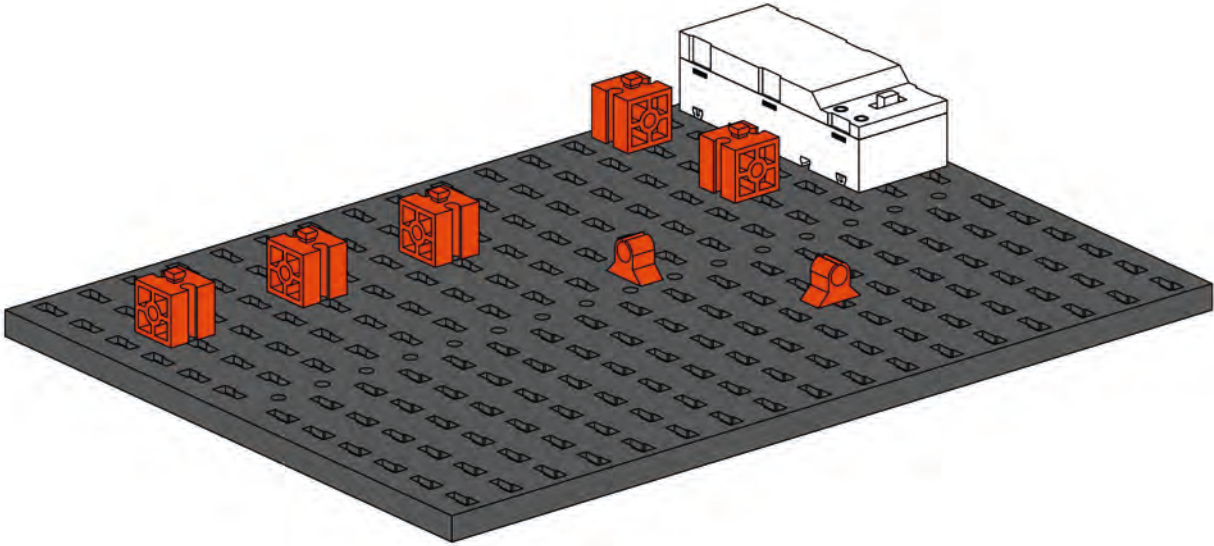
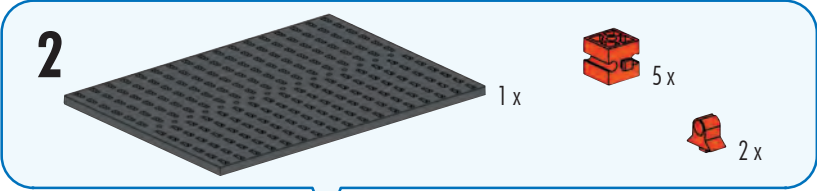
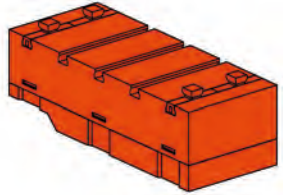
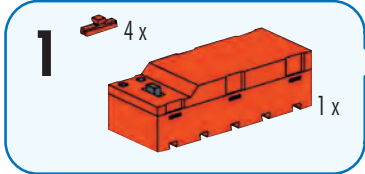

Wasmachine
Lavadora
Máquina de lavar
roupa

Lavatrice
Стиральная
машина
洗衣机



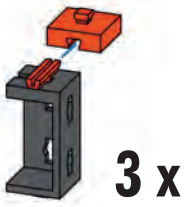
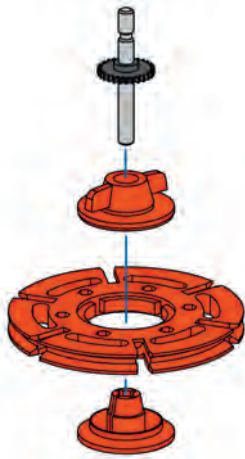



4  1x  1x  1x  1x

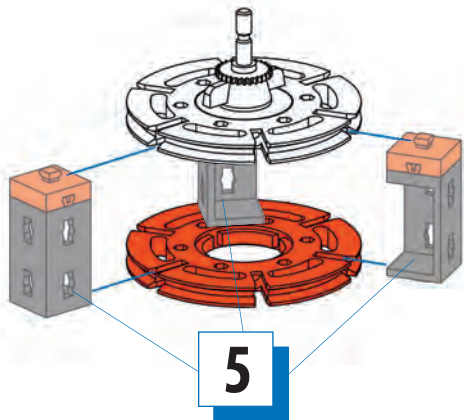

5  3x  3x  3x

6  1x



7  2x  2x  2x

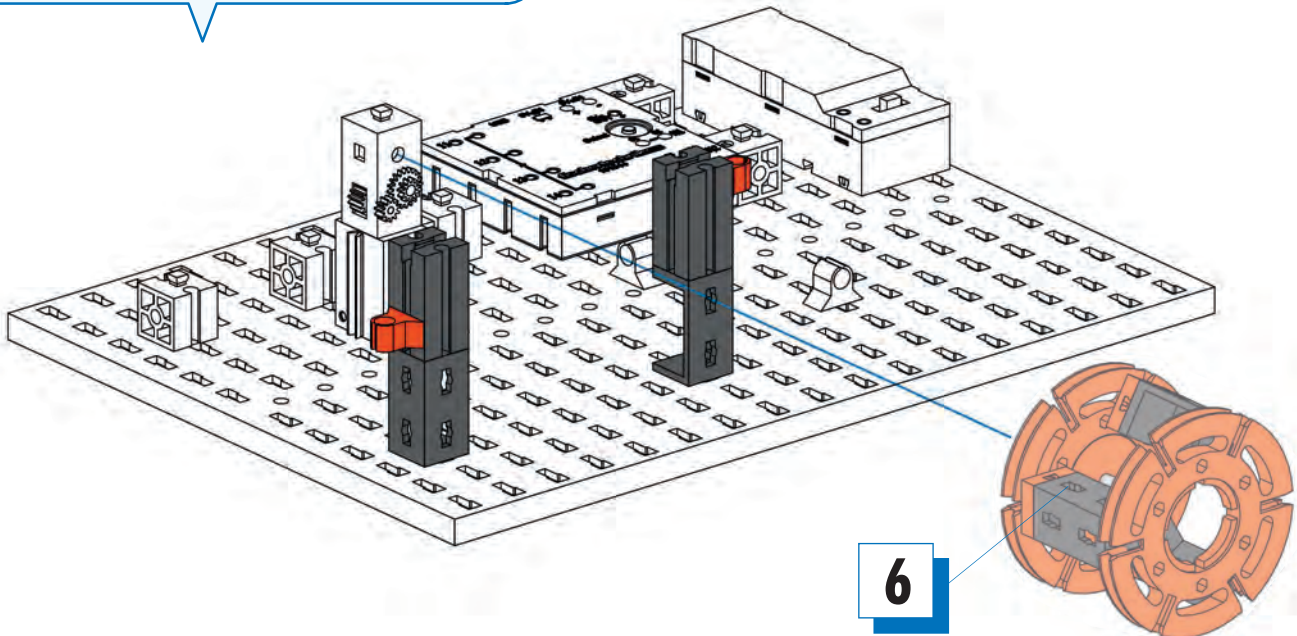

8



2x



1x



1x



1x



1x



1x

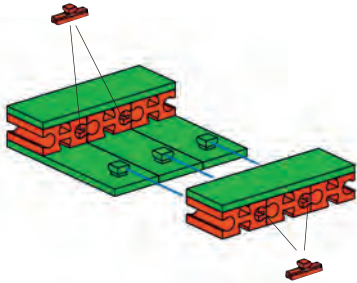
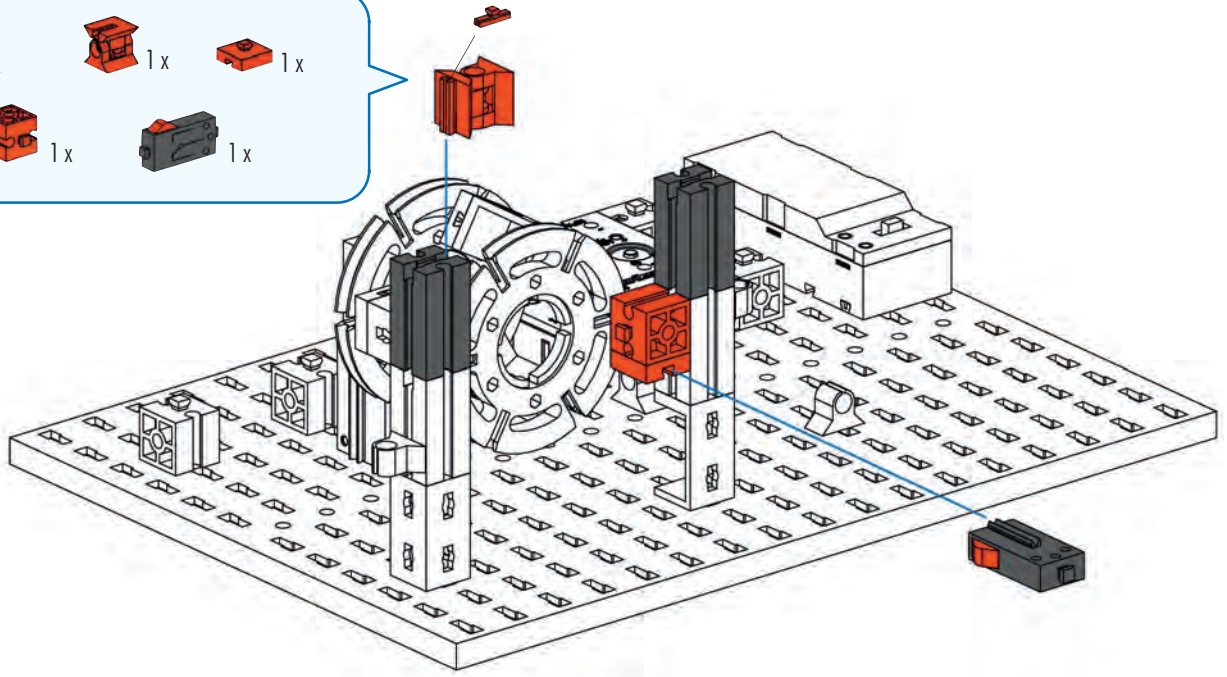

9



6x



4x

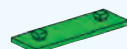

5x

10



1x



1x



1x

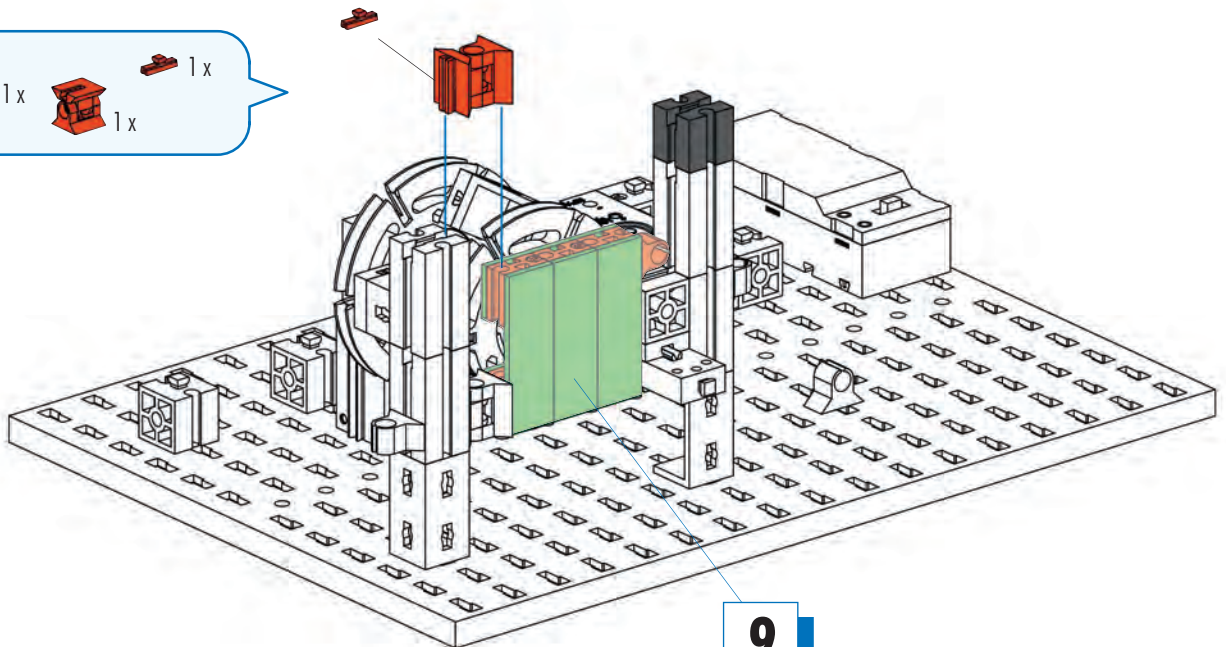

9

11 2x 1x L 1x

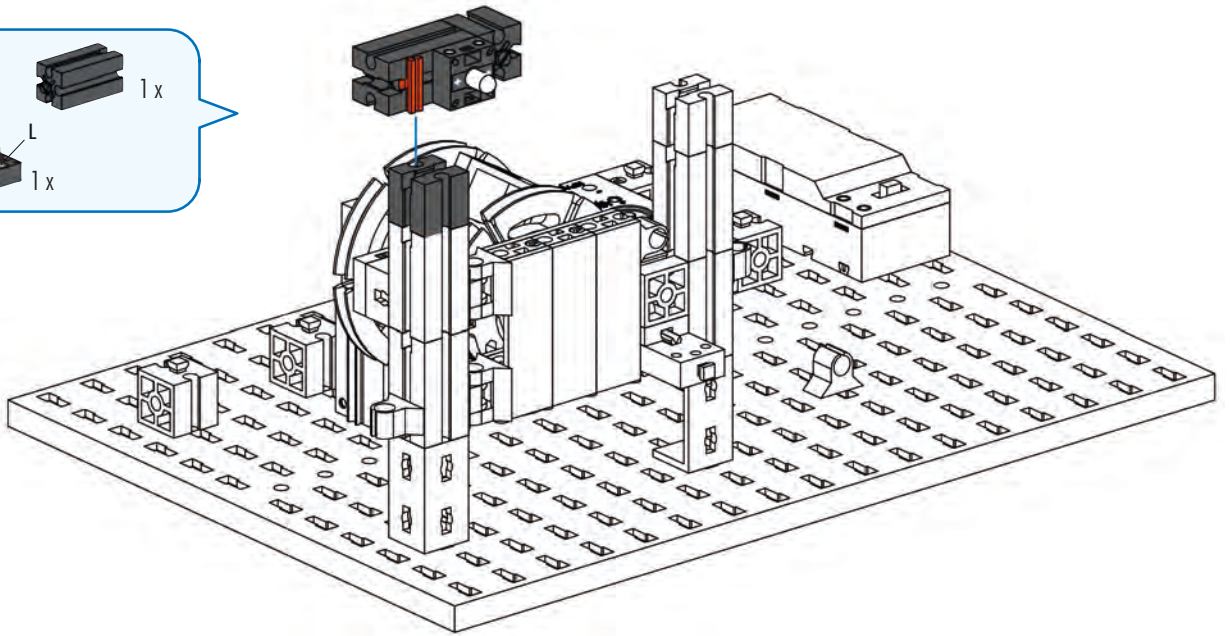

12 2x 1x 1x

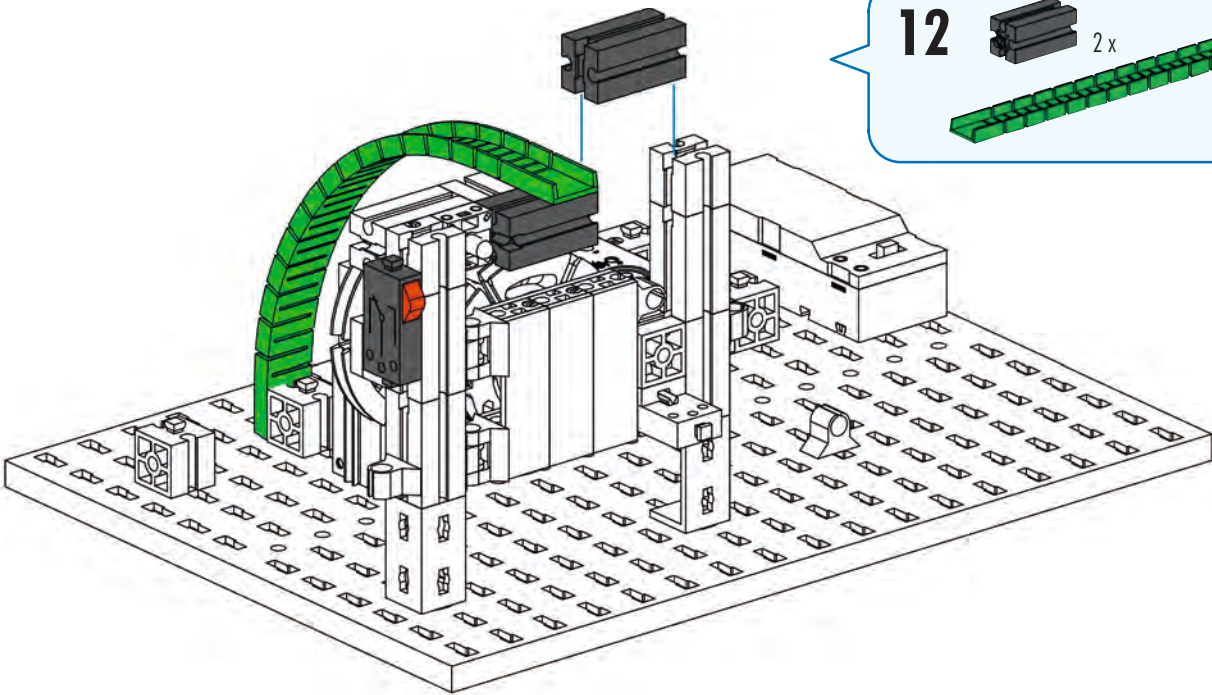

13 2x 1x

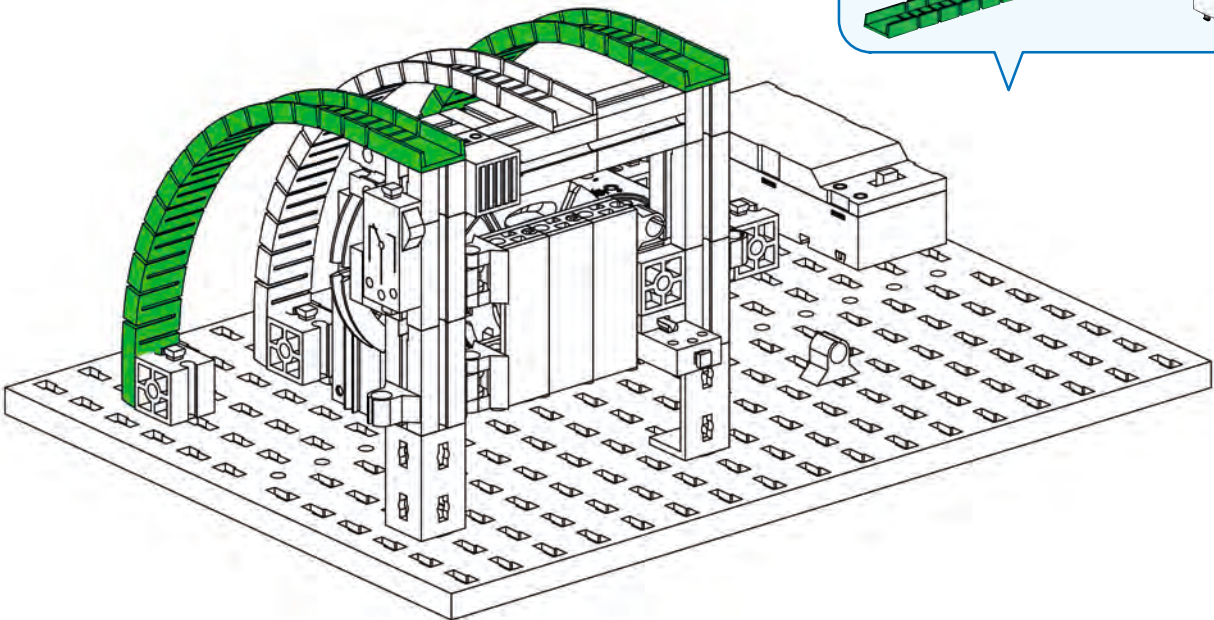

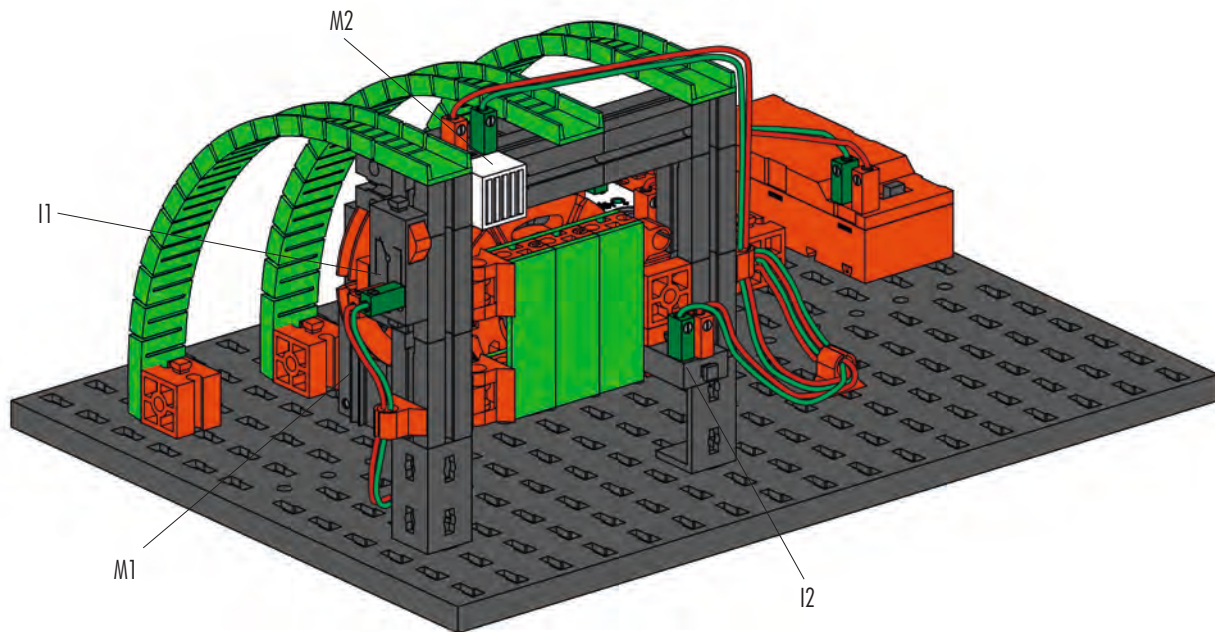

Schaltplan
Circuit diagram
Plan électrique

Schakelschema
Diagrama de circuitos
Plano elétrico de ligação

Schema elettrico
Схема подключения
电路图

Anschlüsse 1 und 3 verwenden!
 Use connections 1 and 3!
 Utiliser les raccordements 1 et 3 !
 Aansluitingen 1 en 3 gebruiken!
 ¡Emplear conexiones 1 y 3!
 Utilizar as conexões 1 e 3!
 Usare le connessioni 1 e 3!
 Используйте контакты 1 и 3!
 请使用接头 1 和 3 !

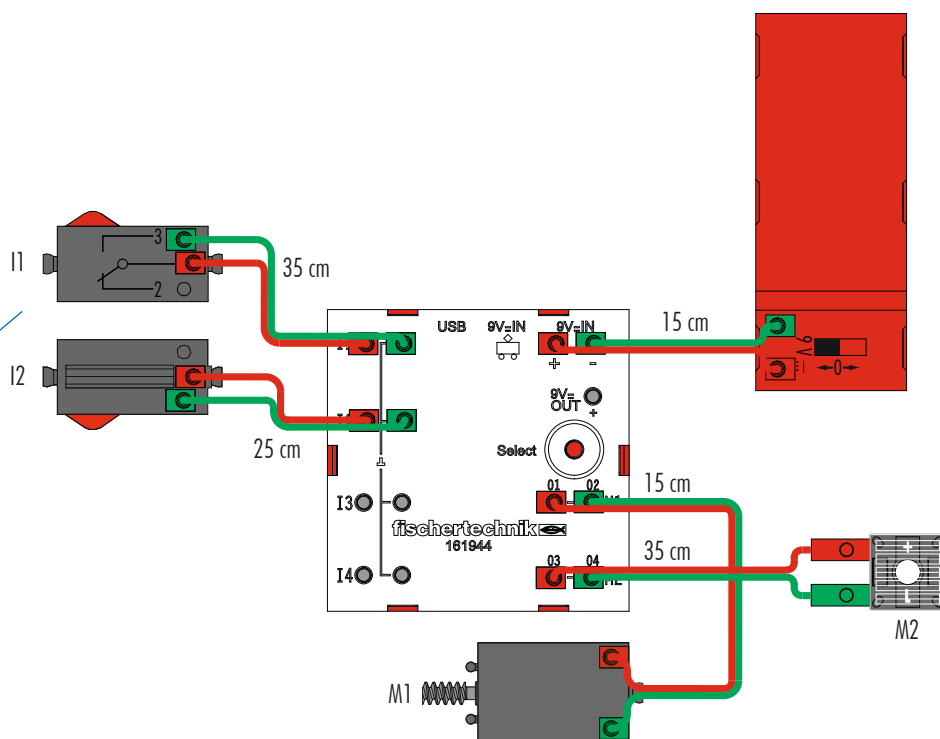

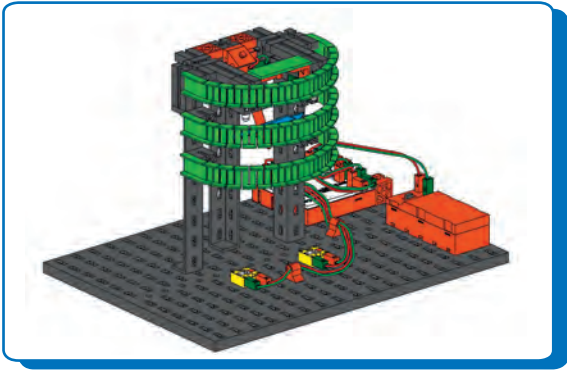

Händetrockner
Hand dryer
Sèche-mains

Handdroger
Secador de manos
Secador de mãos

Apparecchio
asciugamani
Сушилка для рук
干手机

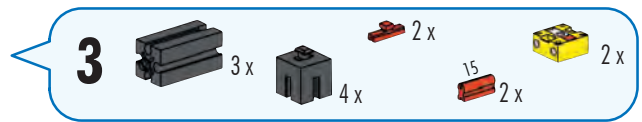
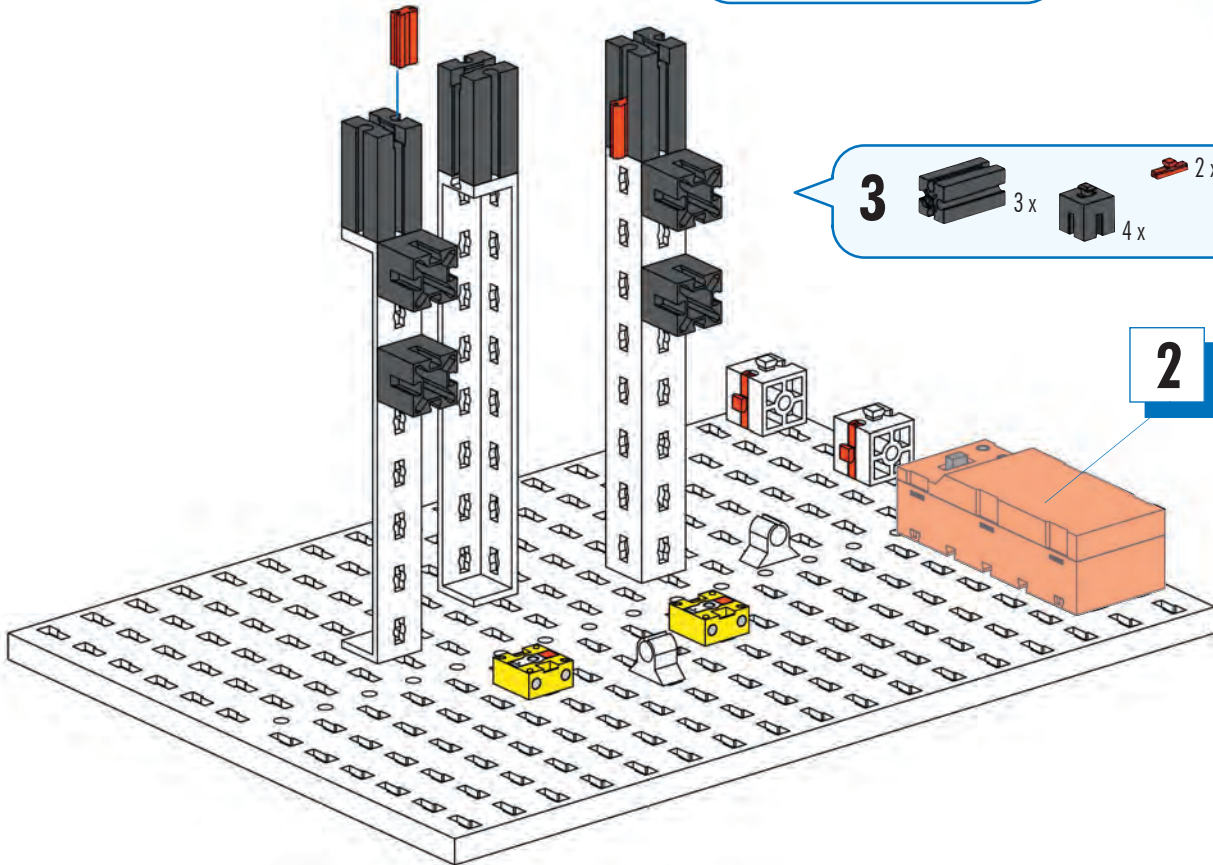
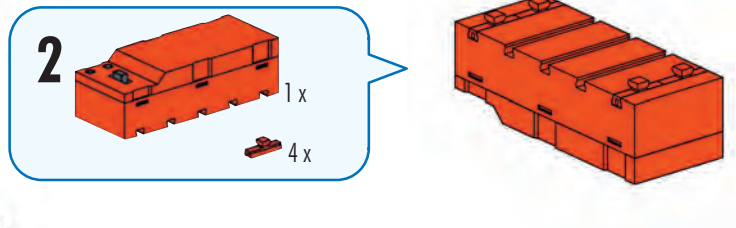
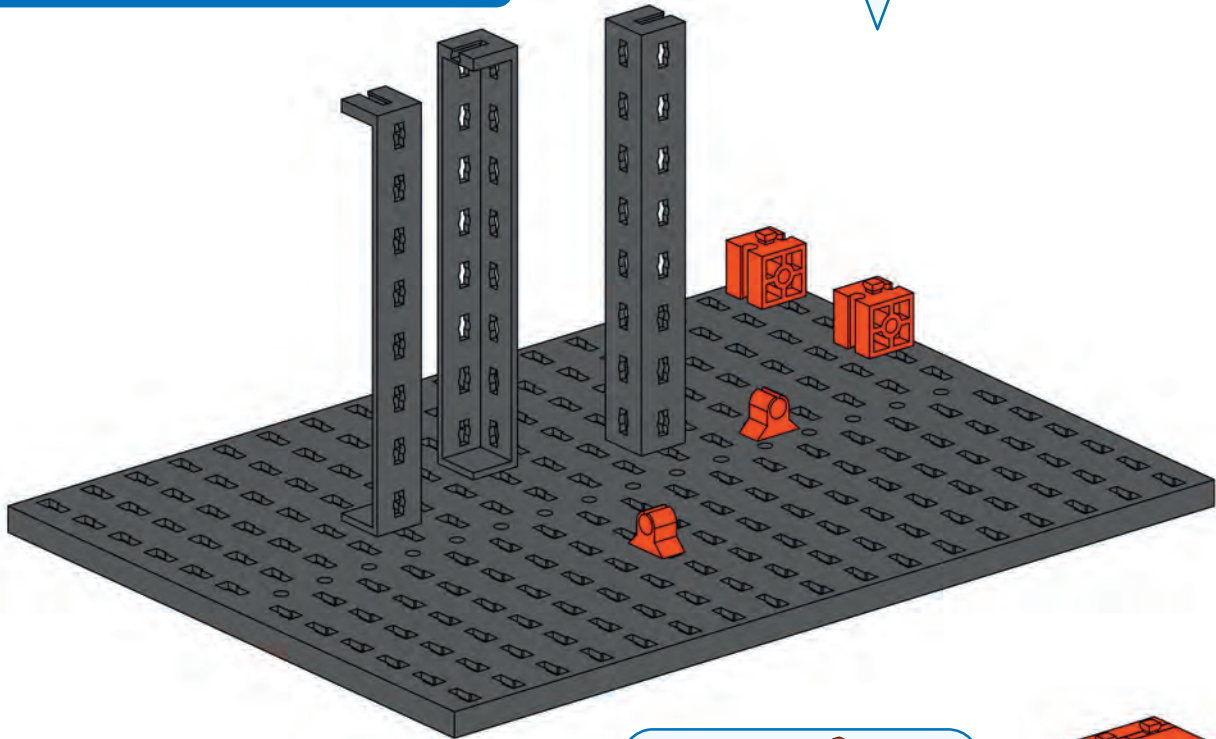
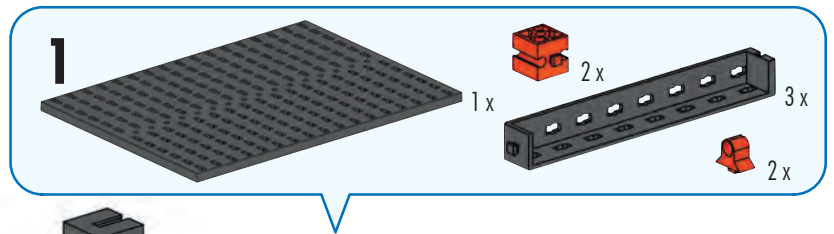

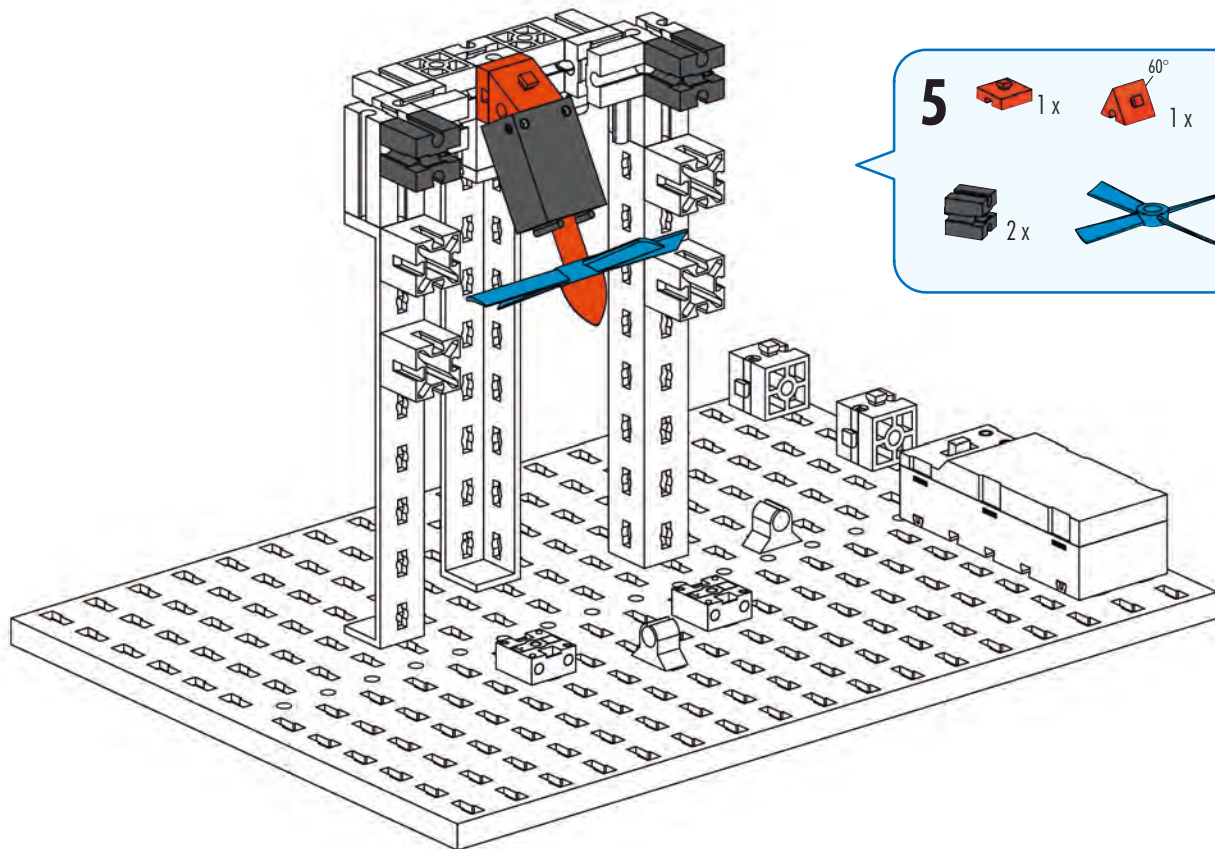
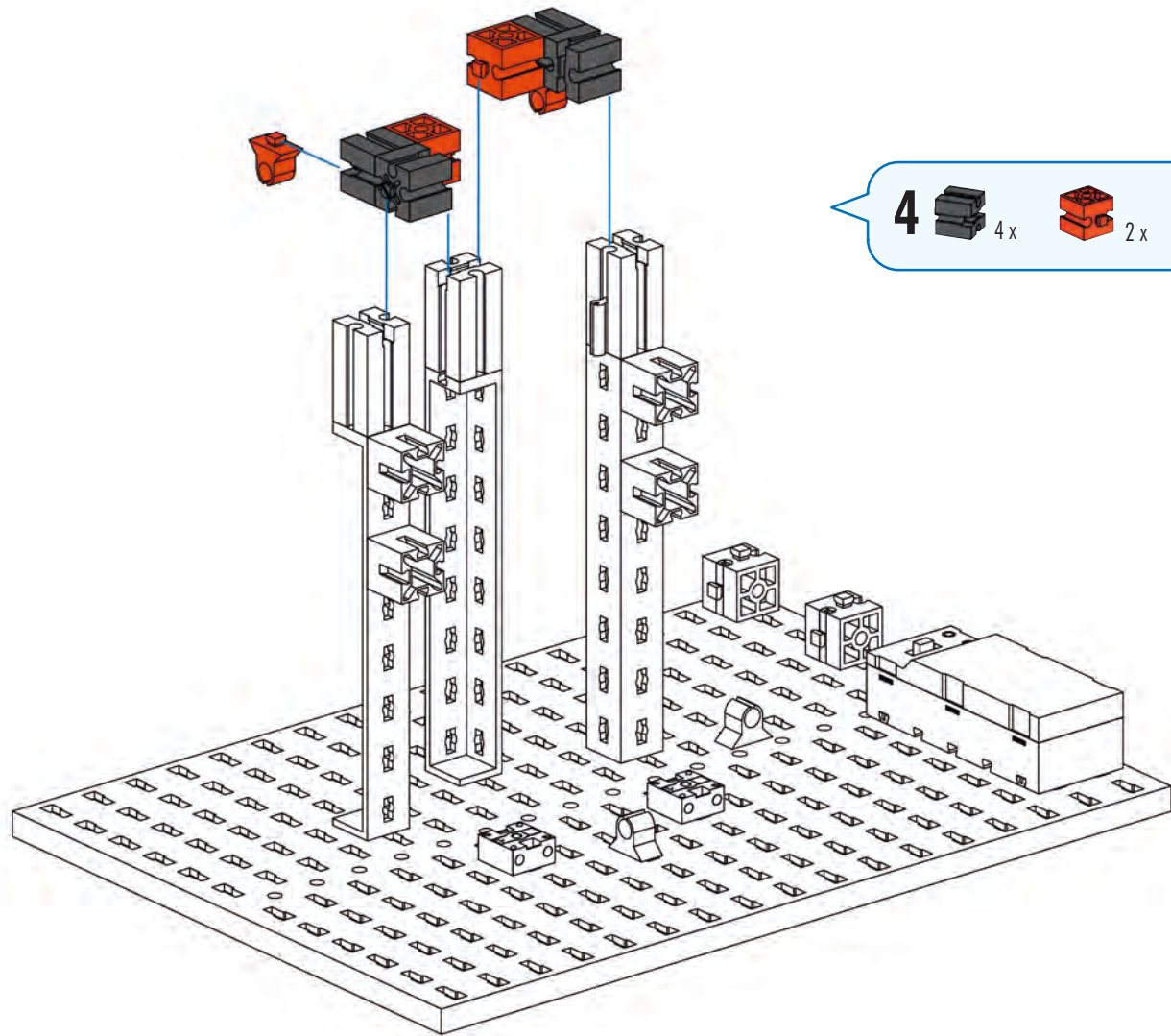

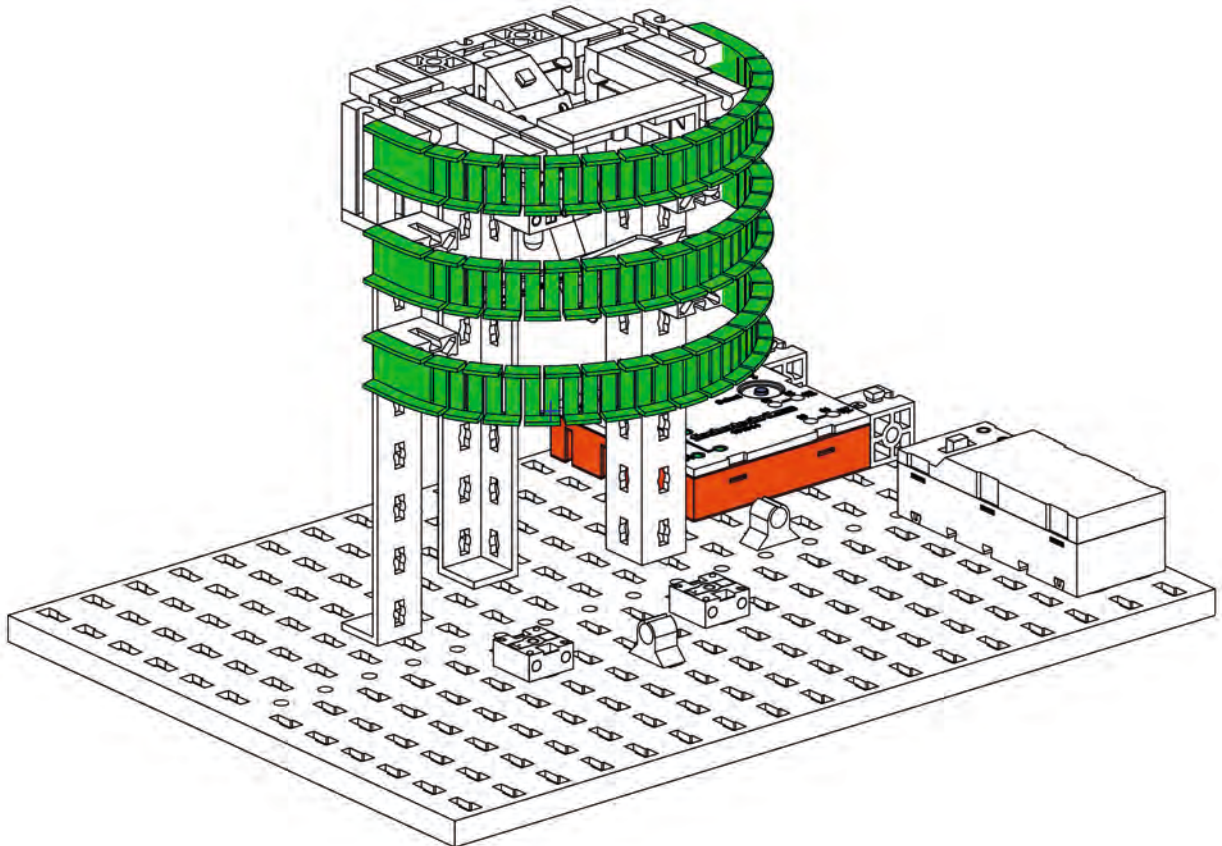
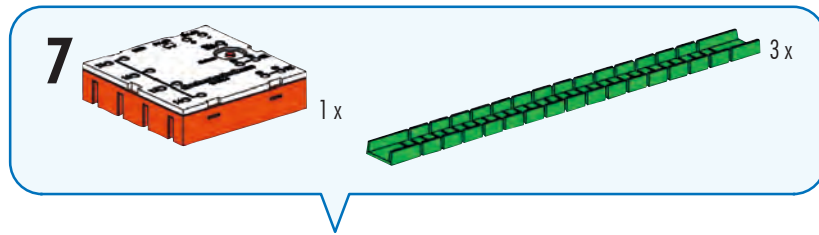
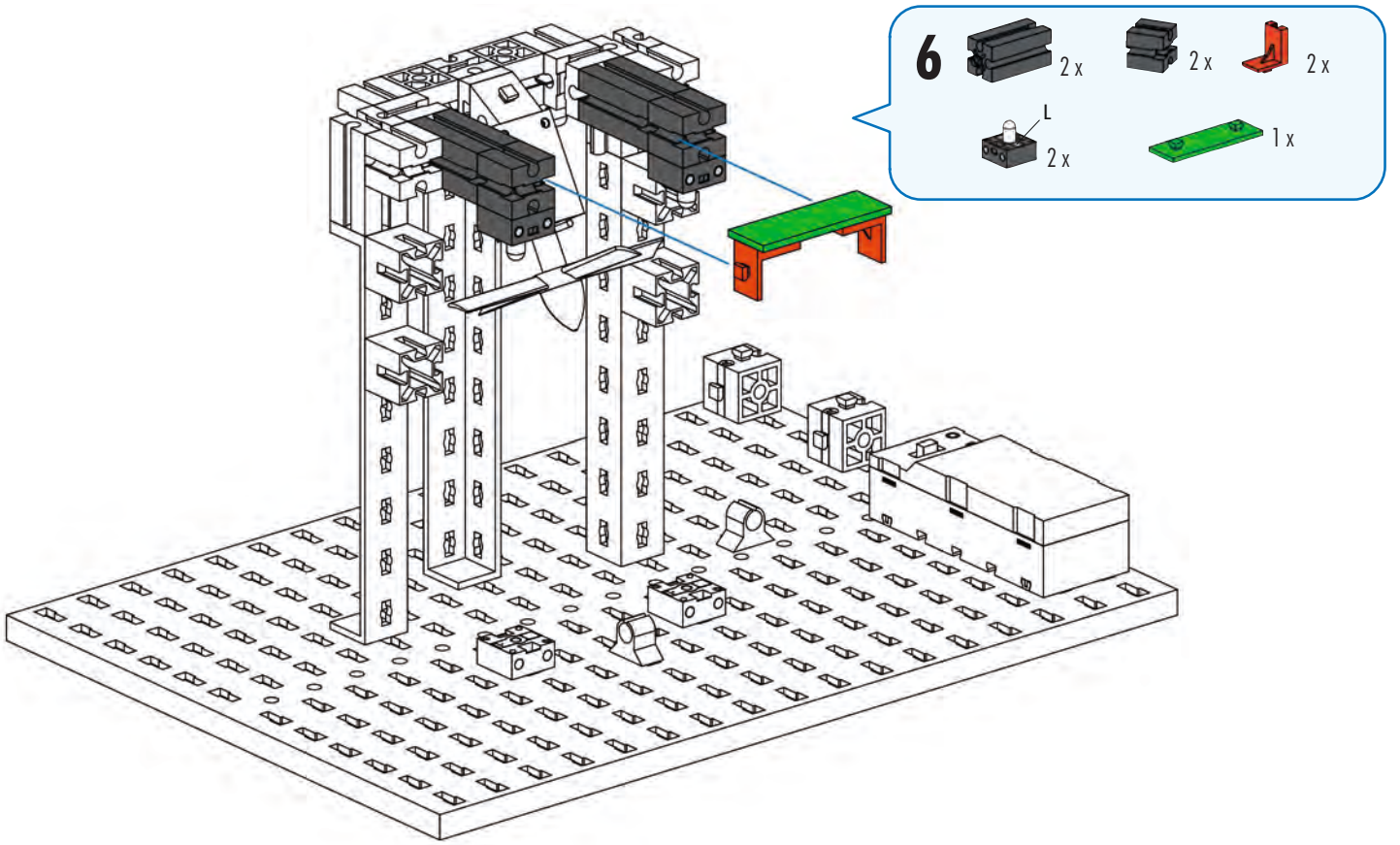

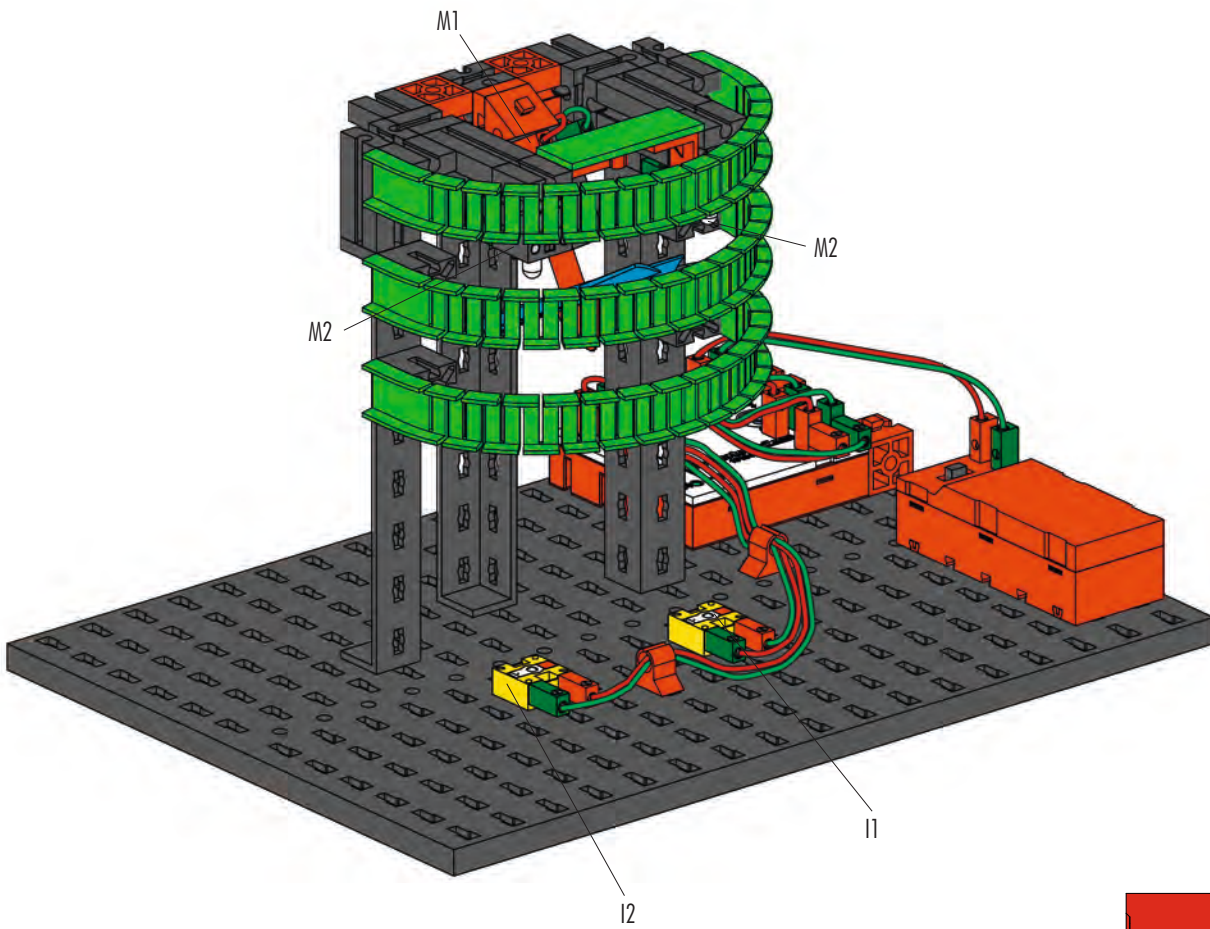

Schaltplan
Circuit diagram
Plan électrique

Schakelschema
Diagrama de circuitos
Plano elétrico de ligação

Schema elettrico
Схема подключения
电路图

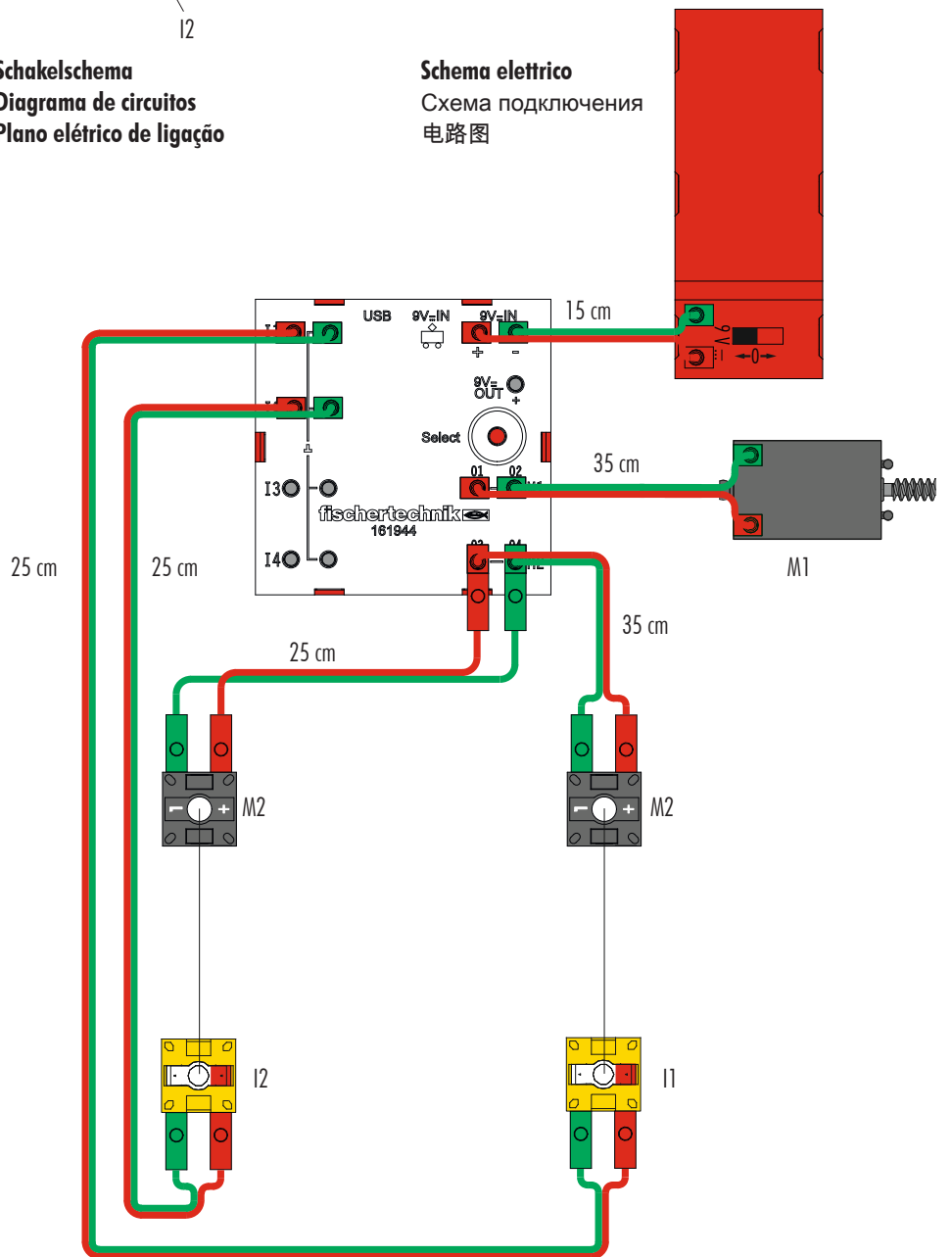

5



1x



3x



2x



1x



4x



1x

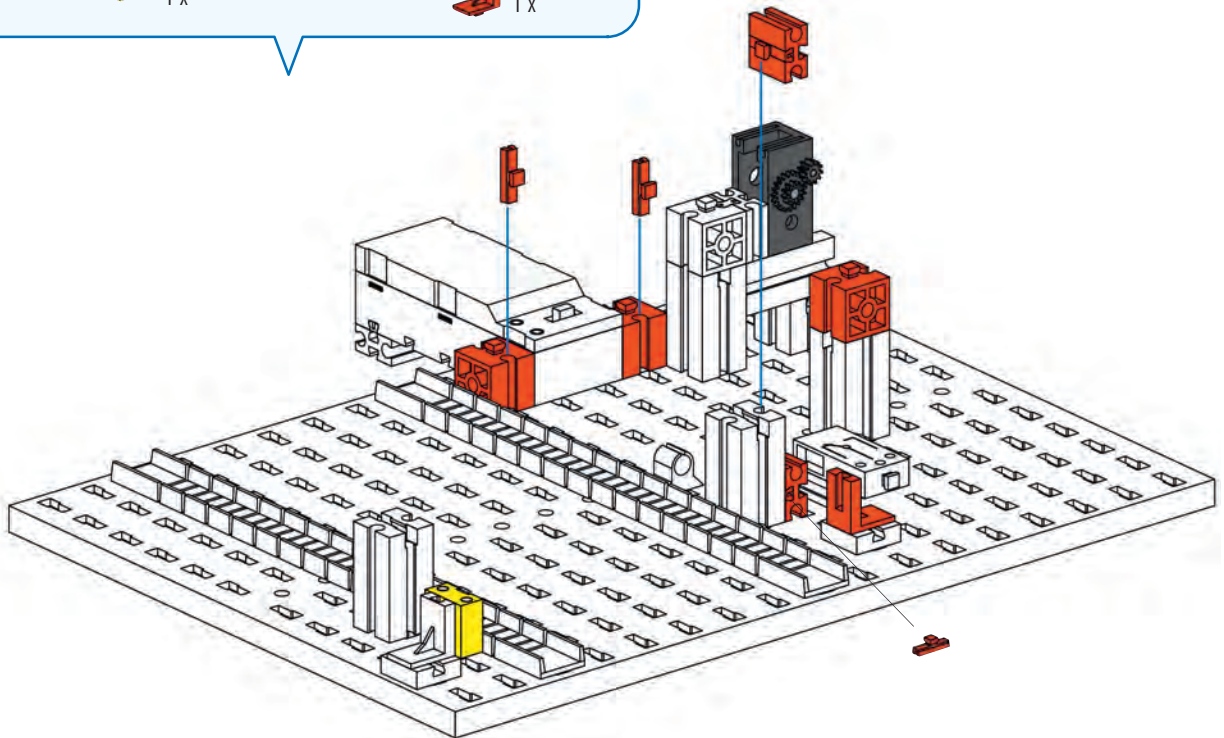

6



1x



1x



1x



1x



1x



1x

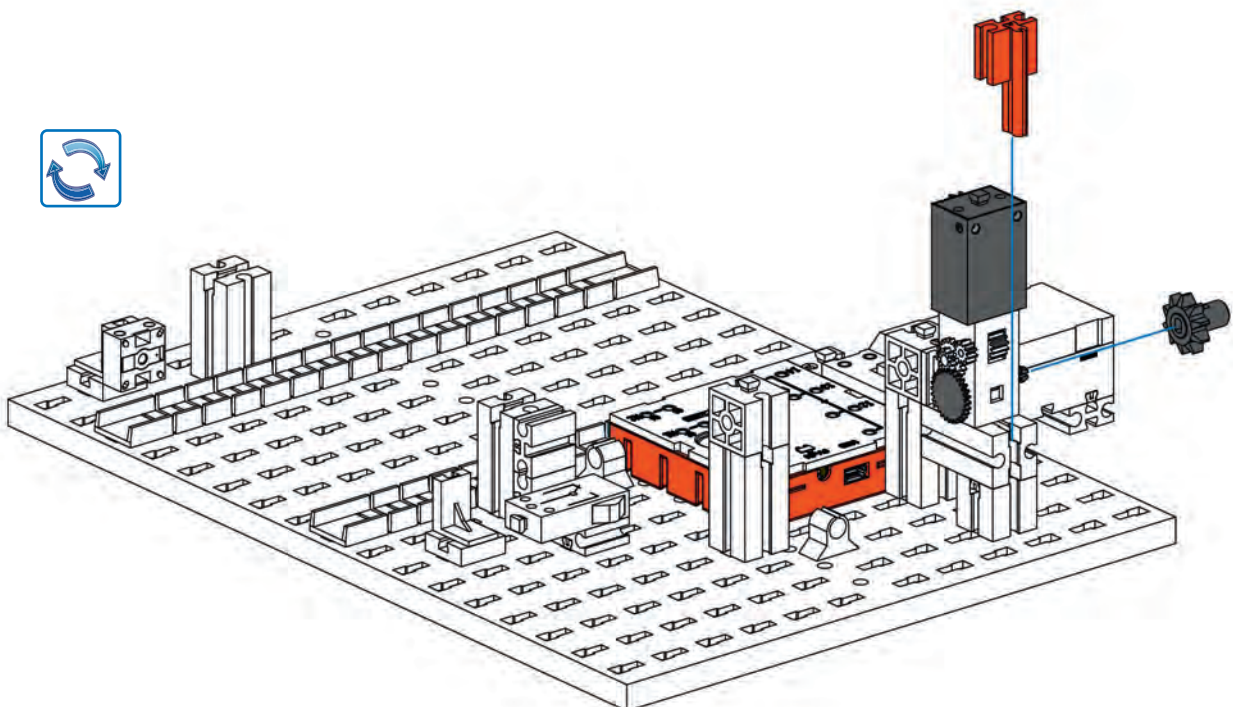

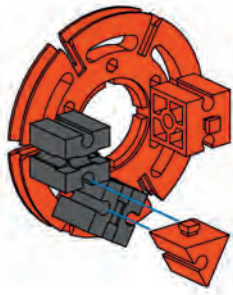

6

- 1 x Orange ring
- 1 x Grey connector
- 2 x Grey pins
- 1 x Orange 1x2 Technic brick
- 1 x Orange 60° Technic wedge

7

- 1 x Grey 11-hole Technic beam
- 1 x Grey 1x2 Technic brick
- 1 x Orange 30mm Technic axle
- 1 x Orange 1x2 Technic brick
- 2 x Grey pins
- 1 x Grey 110mm Technic axle
- 2 x Orange Technic bush

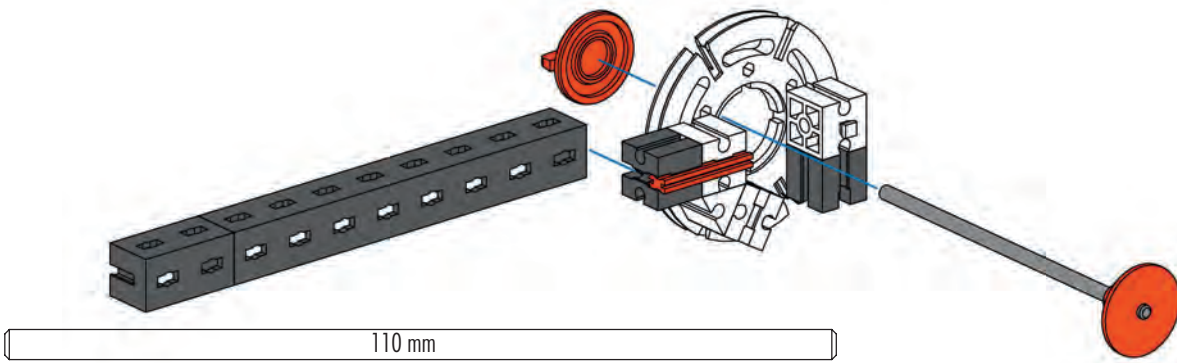

8

- 2 x Orange Technic bush
- 1 x Black gear
- 2 x Green 120mm Technic axle
- 1 x Grey 1x2 Technic brick
- 4 x Red Technic pins
- 1 x Grey L-shaped Technic connector

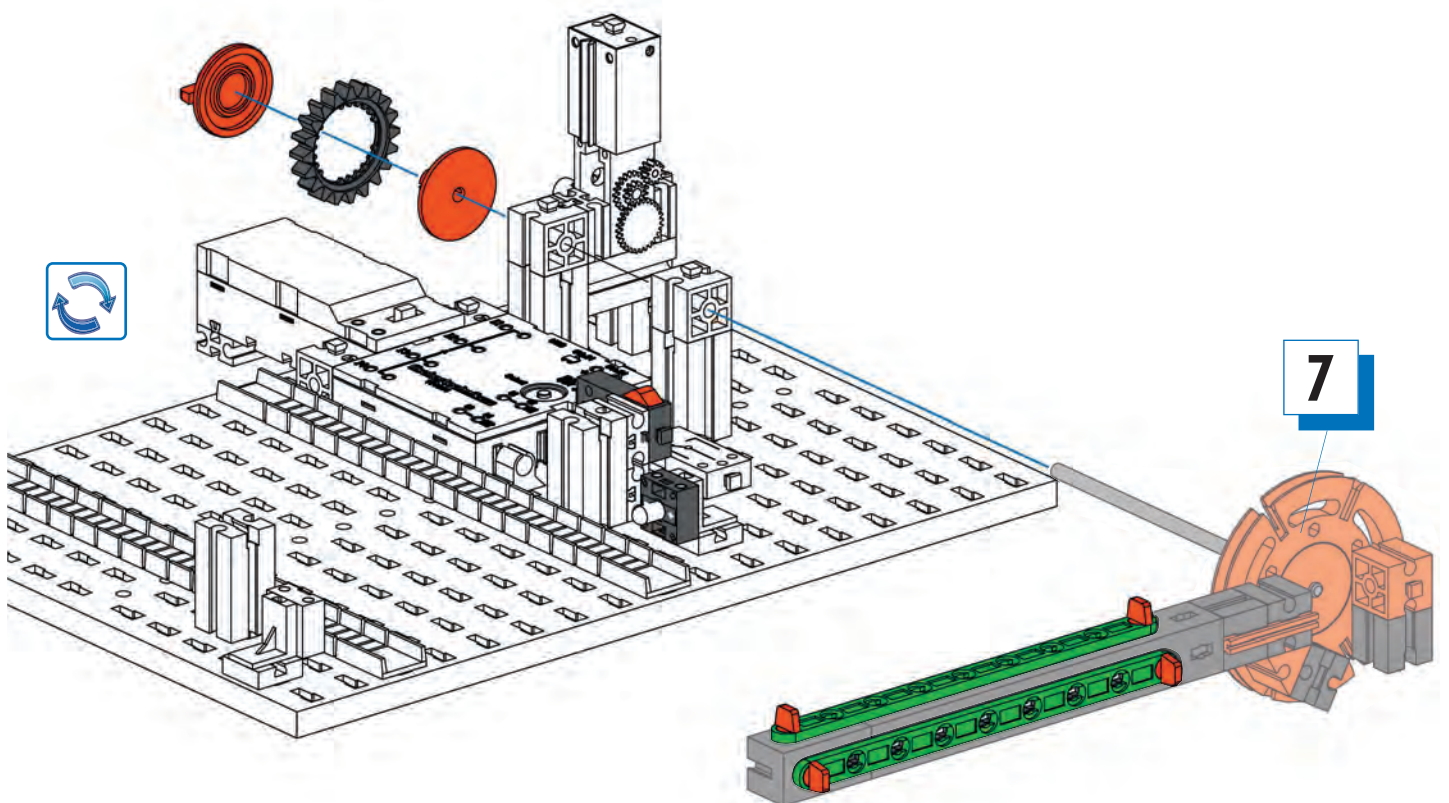

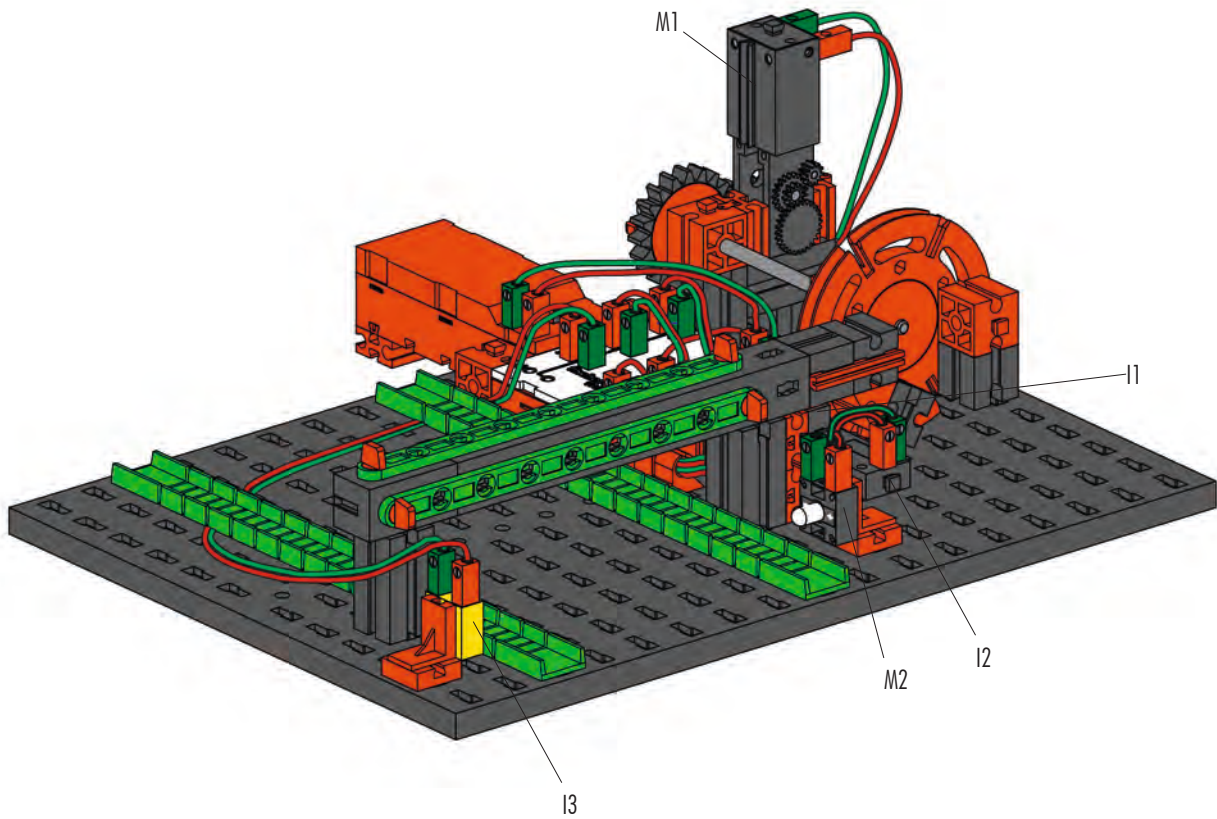

Schaltplan
Circuit diagram
Plan électrique

Schakelschema
Diagrama de circuitos
Plano elétrico de ligação

Schema elettrico
Схема подключения
电路图

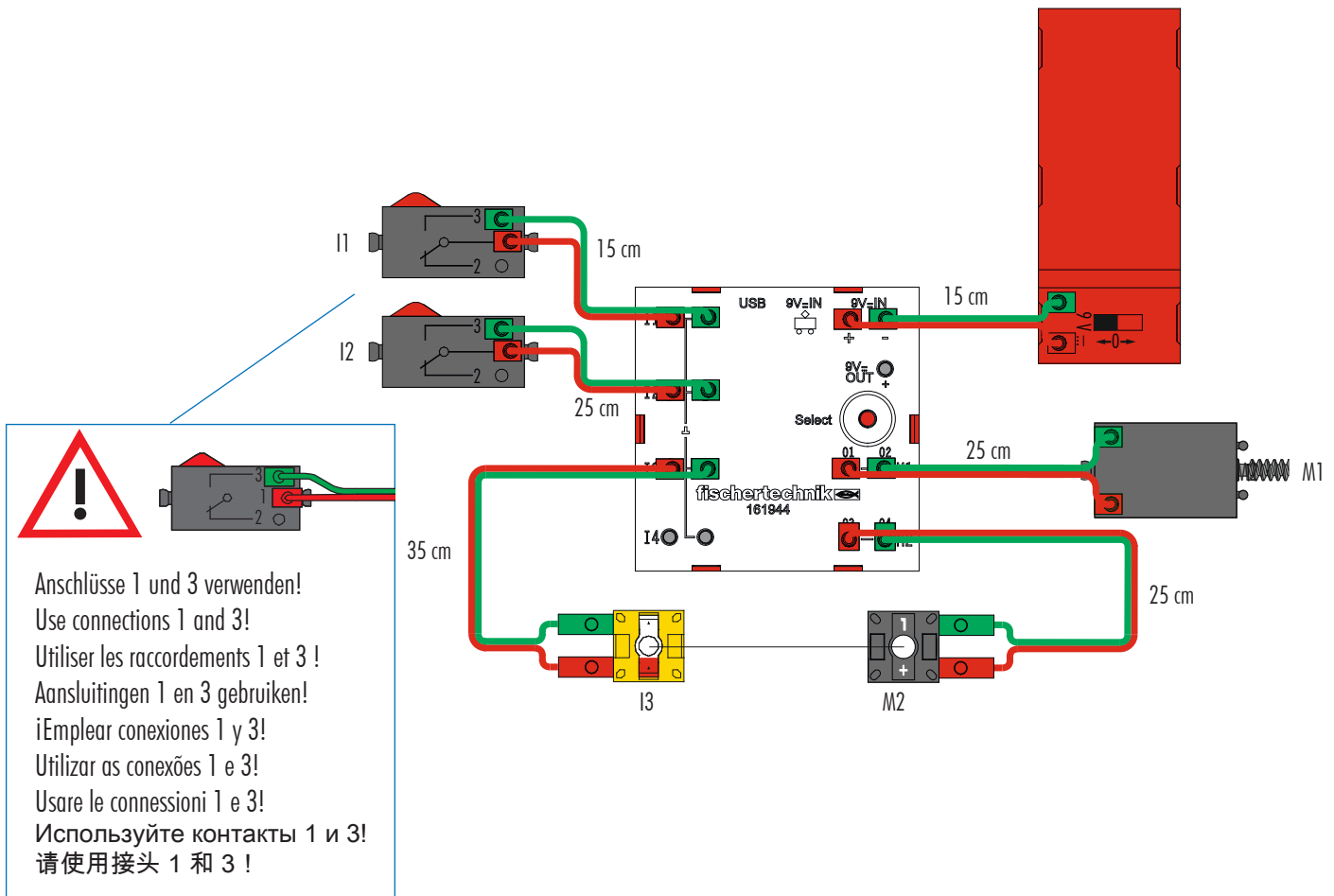

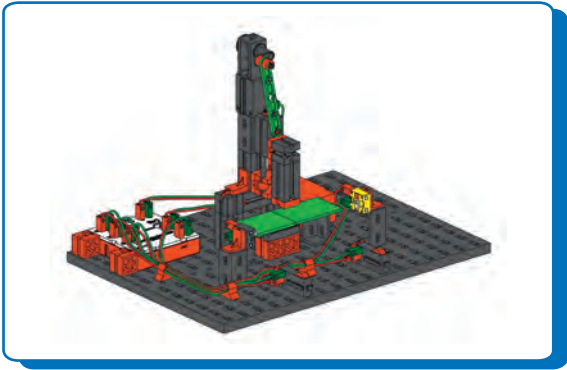



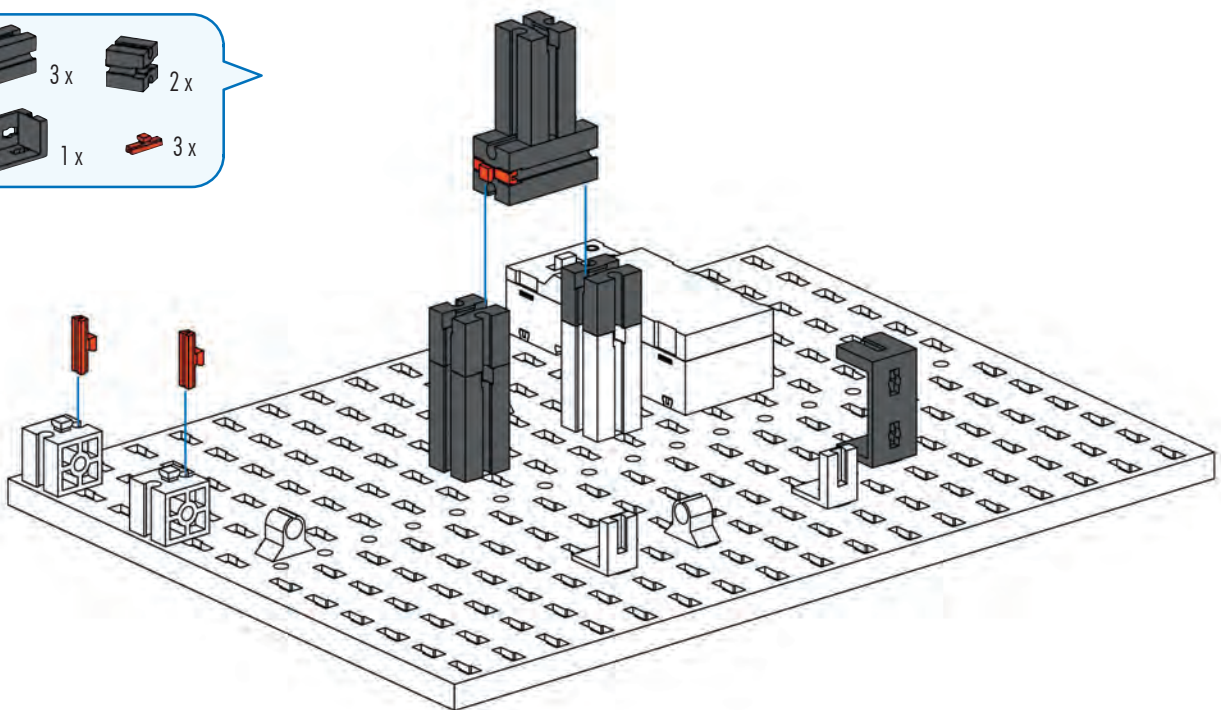
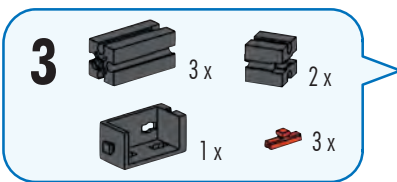
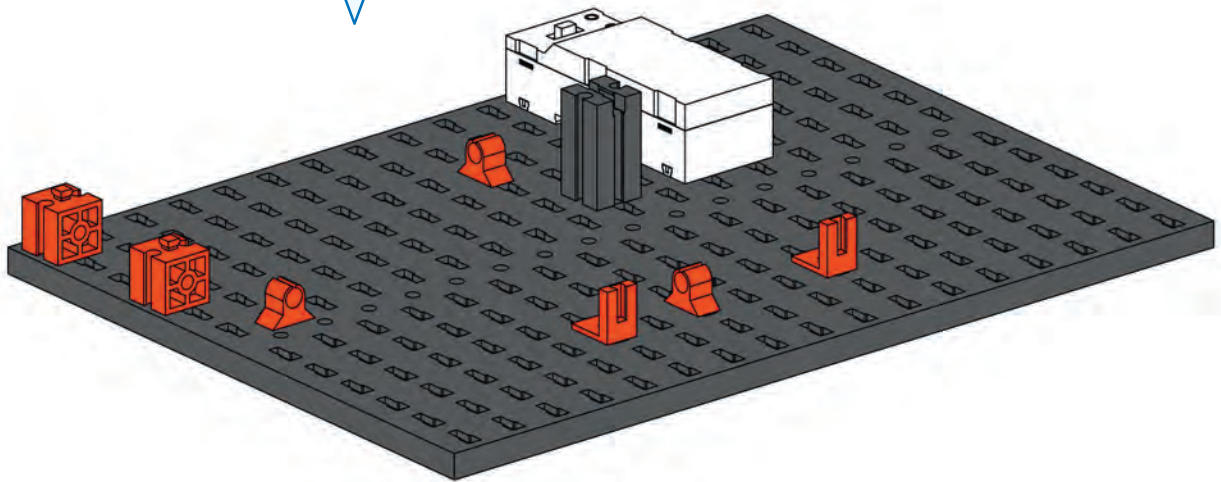
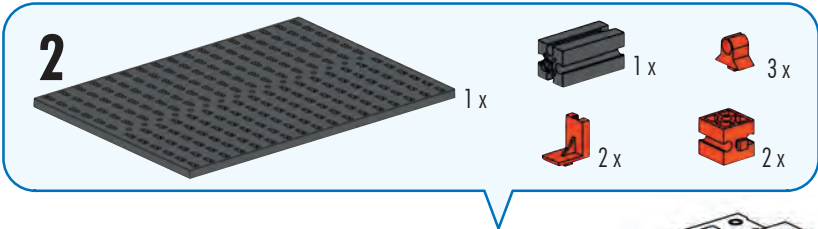
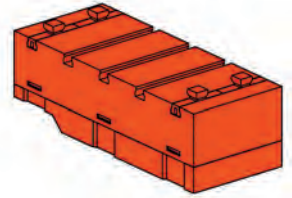
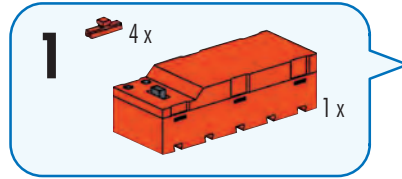

Stanze mit Sicherheitsschalter
 Punch with safety switch
 Poinçon avec interrupteur de sécurité

Stans met veiligheidsschakelaar
 Punzonadora con interruptor de seguridad
 Punção com interruptor de segurança

Punzonatrice con interruttore di sicurezza
 Штамповочный пресс с защитным выключателем
 带安全开关的冲压机

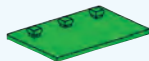

4

- 1x 
- 2x 
- 2x 
- 2x 

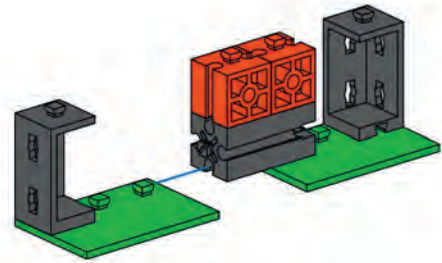

5

- 3x 
- 1x 
- 2x 

4

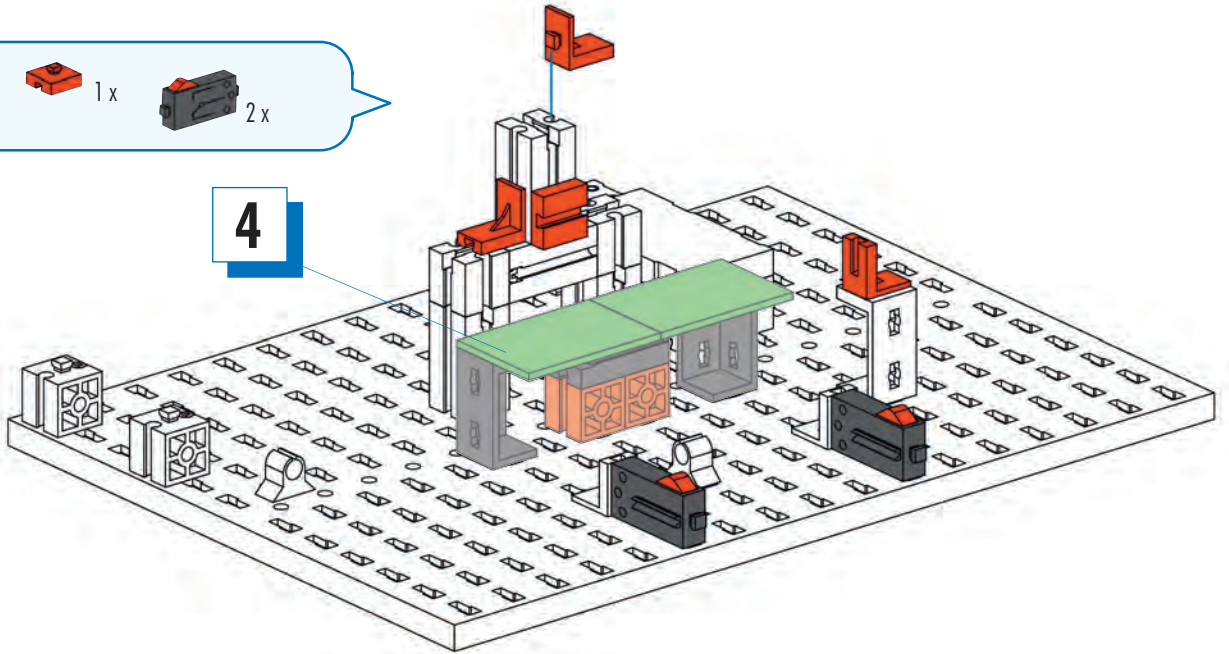

6

- 2x 
- 1x 
- 1x 
- 2x 
- 1x 

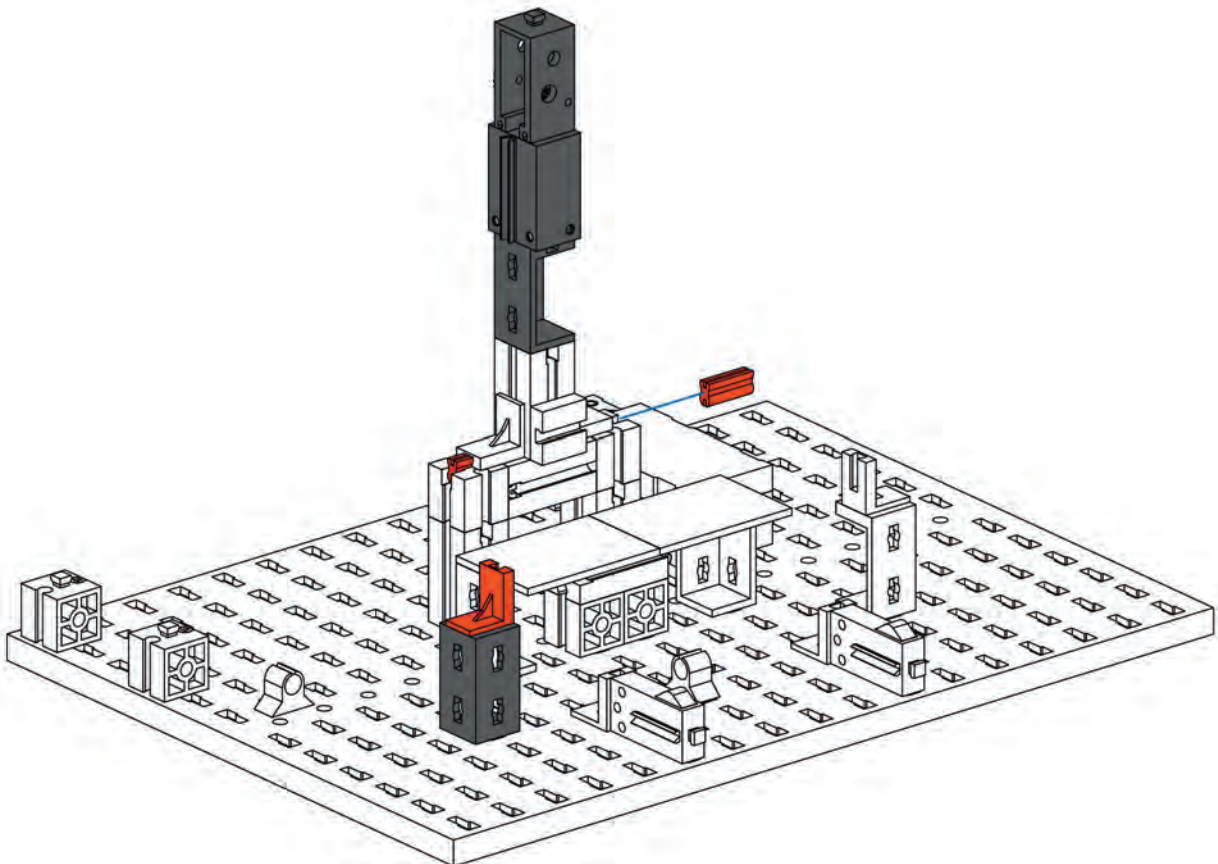

- 7**
- 1x [Screw]
 - 1x [Bracket]
 - 1x [Red Technic Pin]
 - 1x [Red Technic Connector]
 - 2x [60mm Technic Beam]
 - 3x [Red Technic Pin]
 - 1x [Black Technic Pin]
 - 1x [Yellow Technic Pin]

60 mm

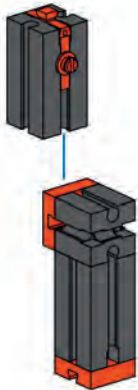
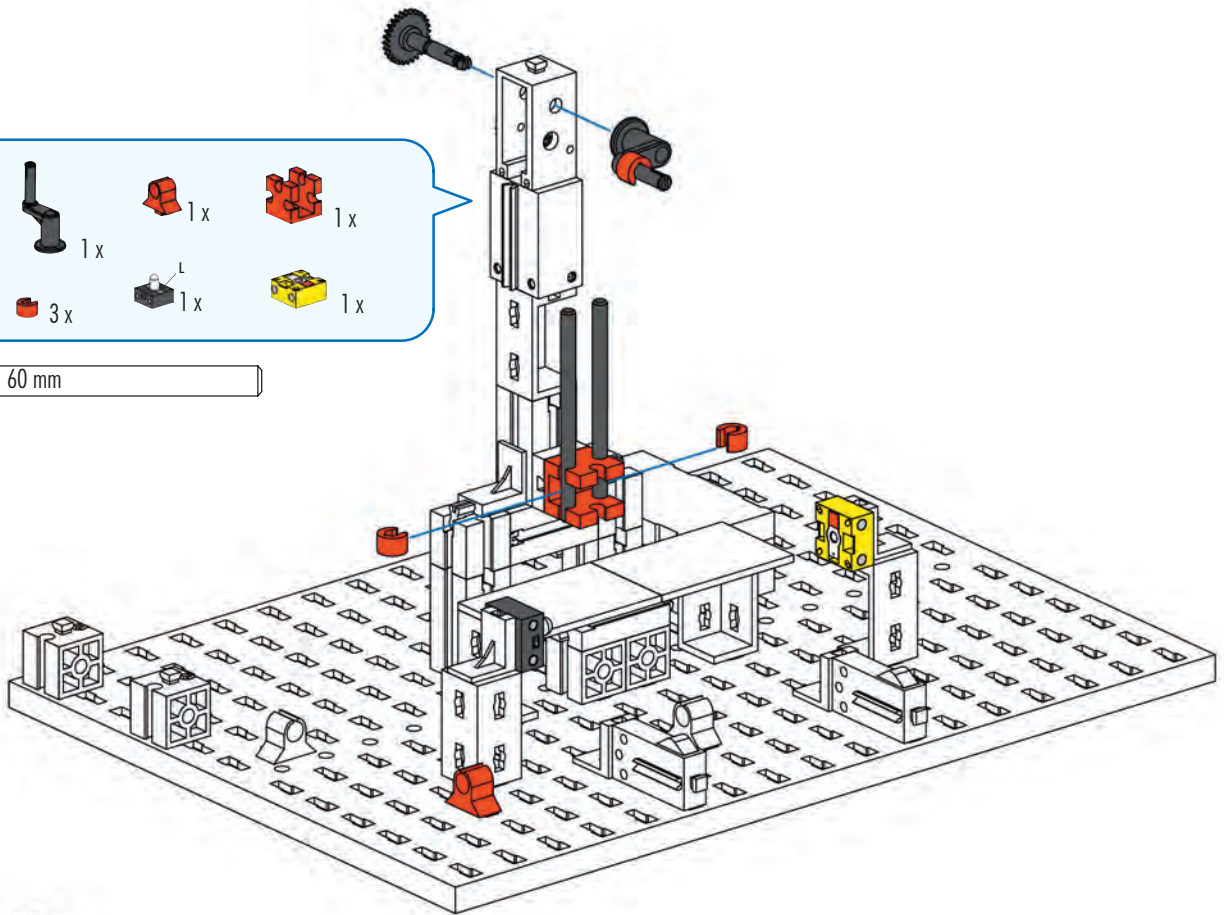

- 8**
- 2x [Grey Technic Beam]
 - 1x [Grey Technic Beam]
 - 2x [Red Technic Pin]
 - 1x [Red Technic Pin]

- 9**
- 1x [Red Technic Plate]
 - 1x [60mm Green Technic Beam]
 - 1x [Red Technic Pin]

8

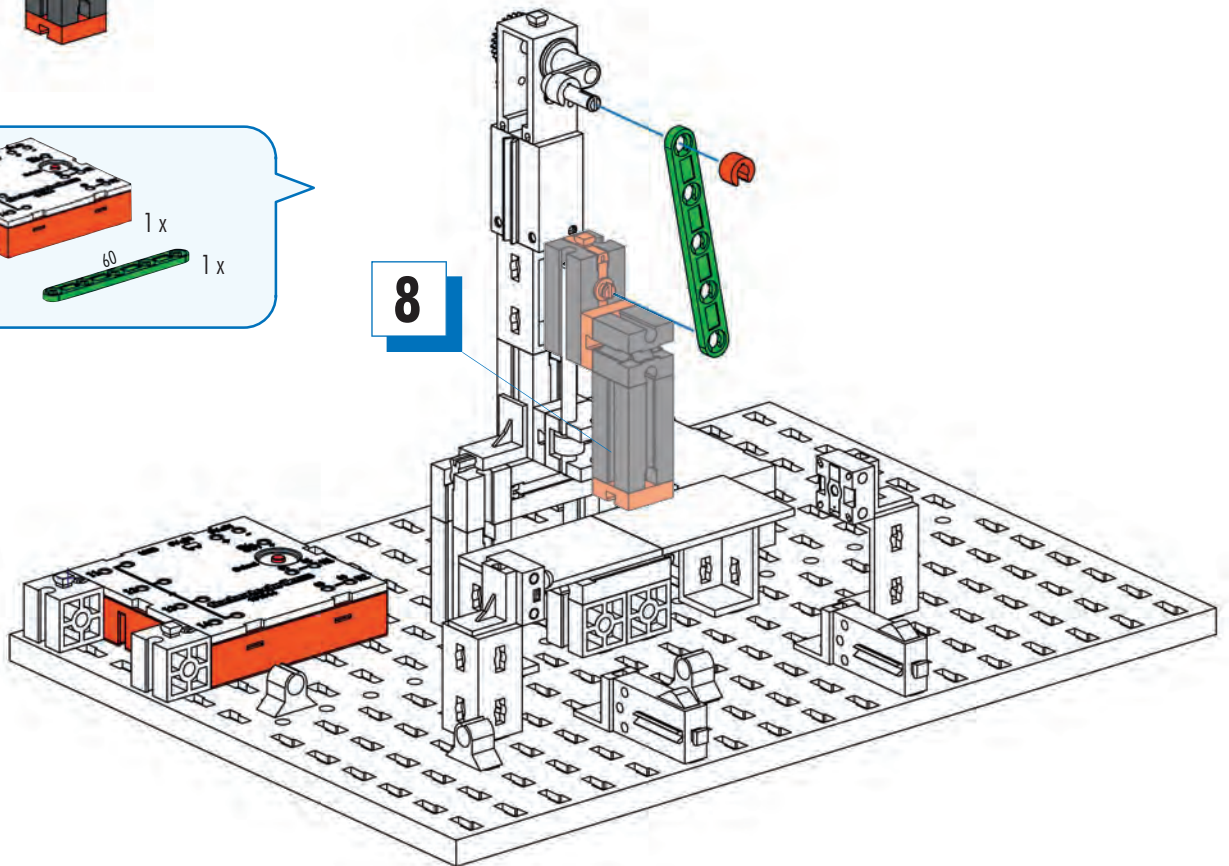

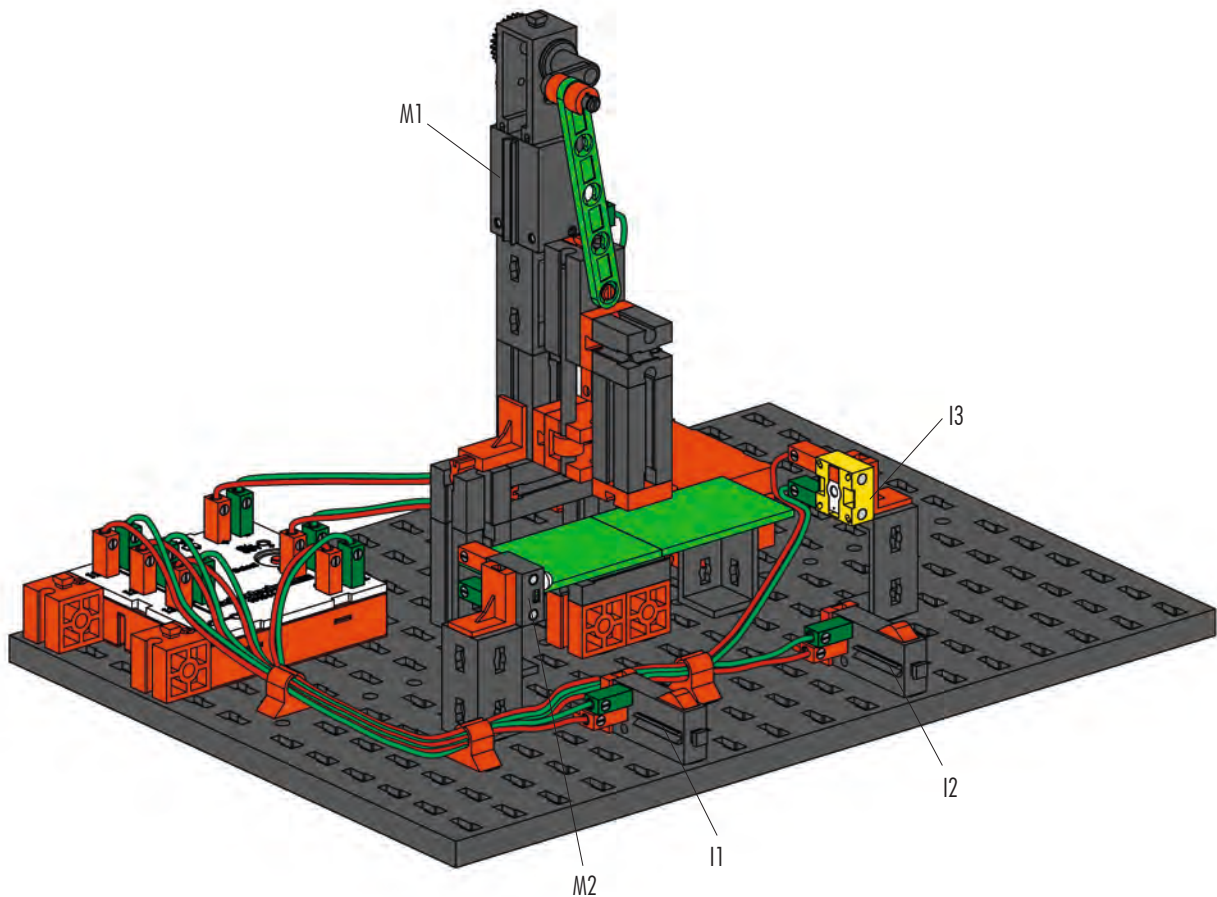



Schaltplan
Circuit diagram
Plan électrique

Schakelschema
Diagrama de circuitos
Plano elétrico de ligação

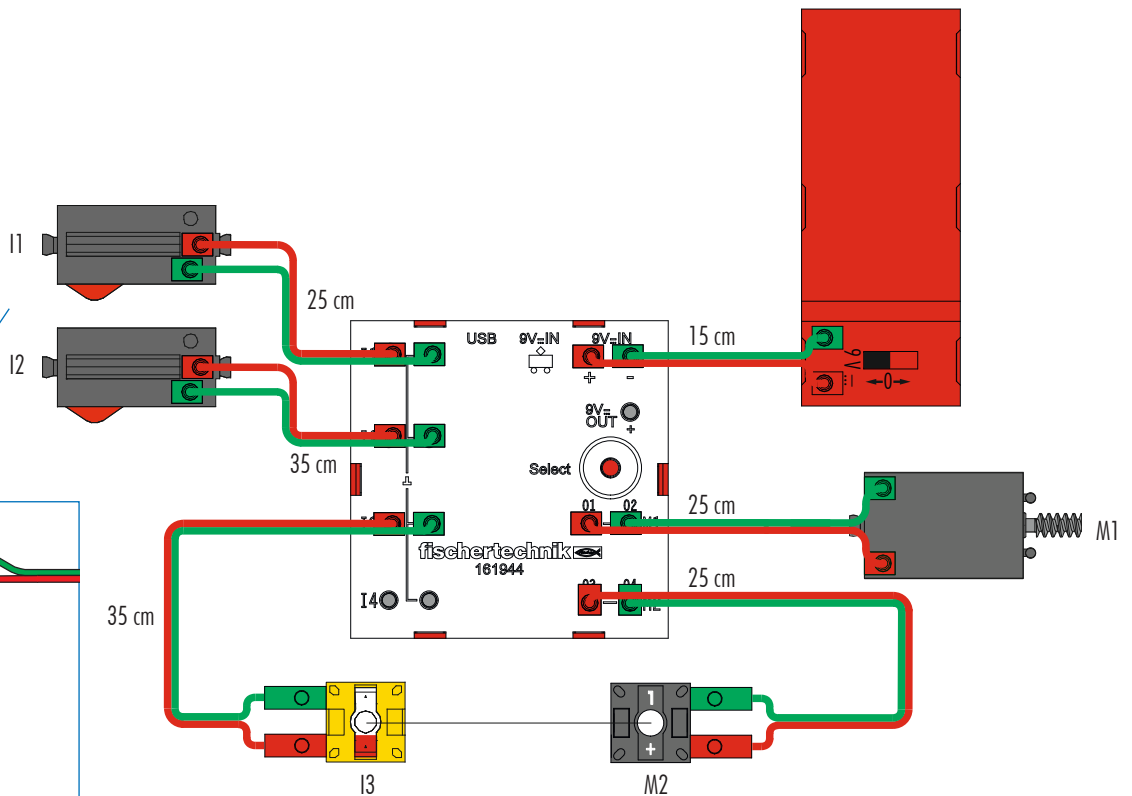
Schema elettrico
Схема подключения
电路图

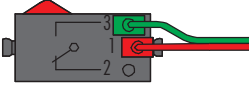

Anschlüsse 1 und 3 verwenden!
Use connections 1 and 3!
Utiliser les raccordements 1 et 3 !
Aansluitingen 1 en 3 gebruiken!
¡Emplear conexiones 1 y 3!
Utilizar as conexões 1 e 3!
Usare le connessioni 1 e 3!
Используйте контакты 1 и 3!
请使用接头 1 和 3 !



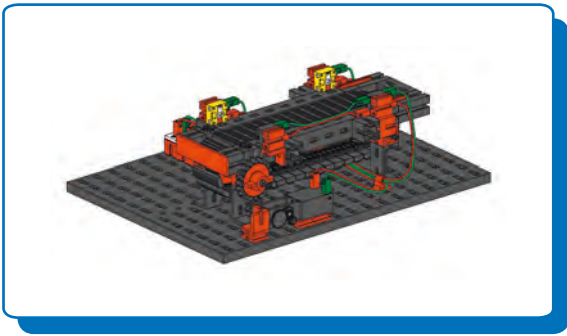



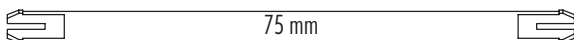
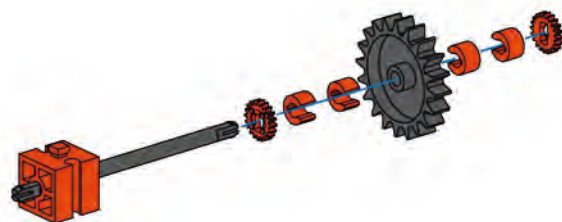
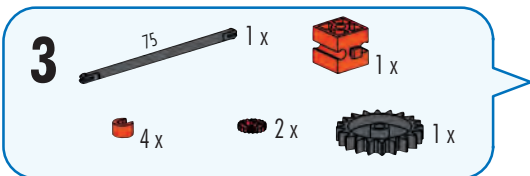
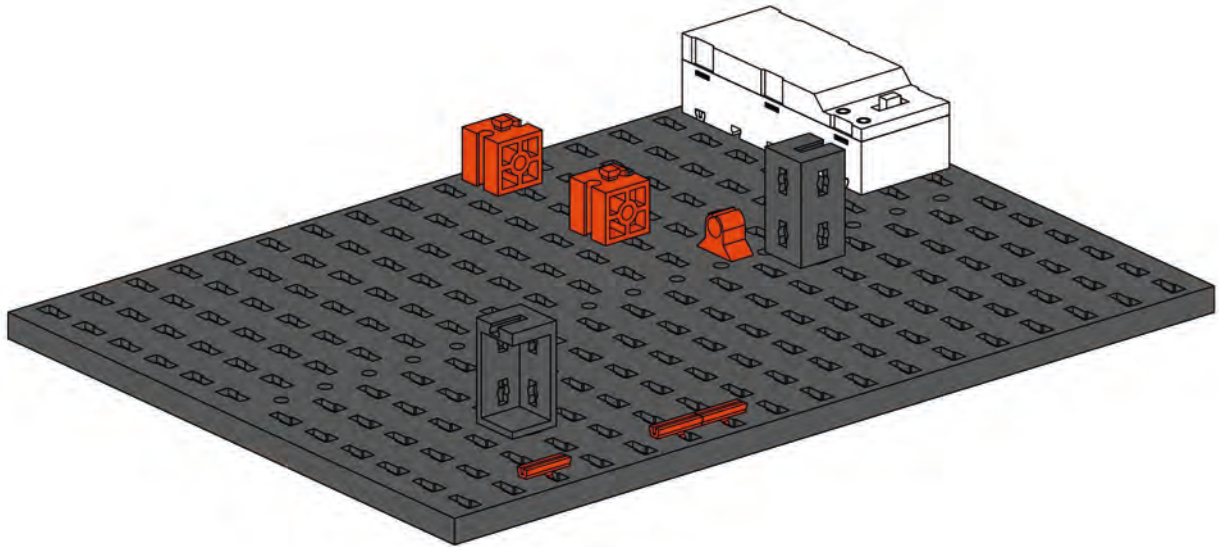
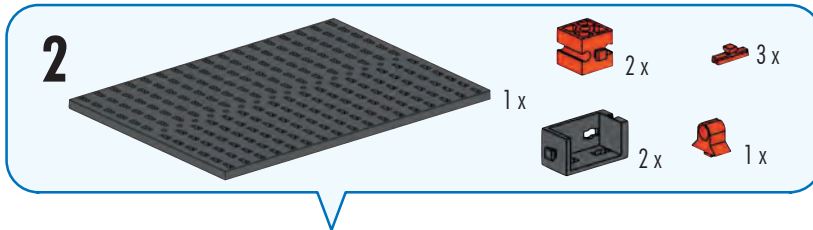
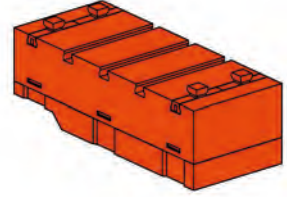
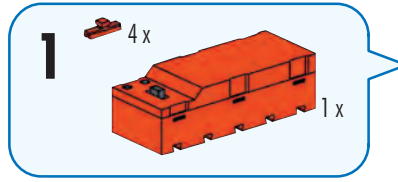

Förderband
Conveyor belt
Bande transporteuse

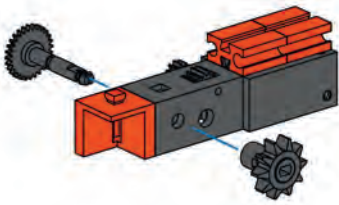

Transportband
Cinta transportadora
Correia transportadora

Nastro trasportatore
Ленточный
транспортер
输送带









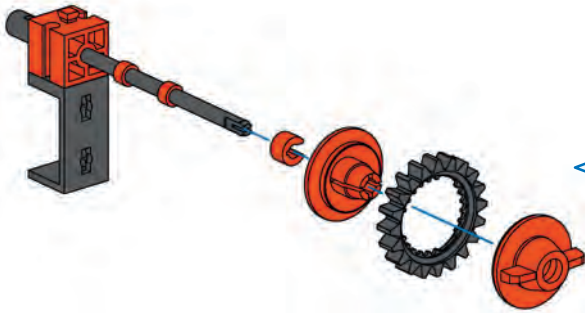
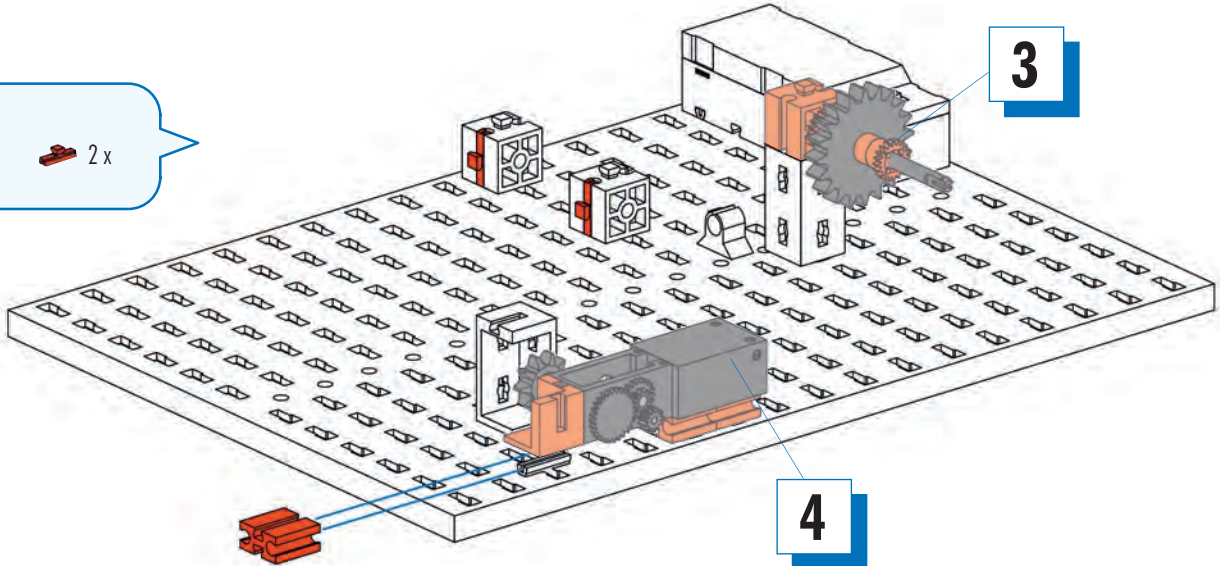







- 4**  1x  1x  1x  1x  2x  1x

- 5**  1x  2x



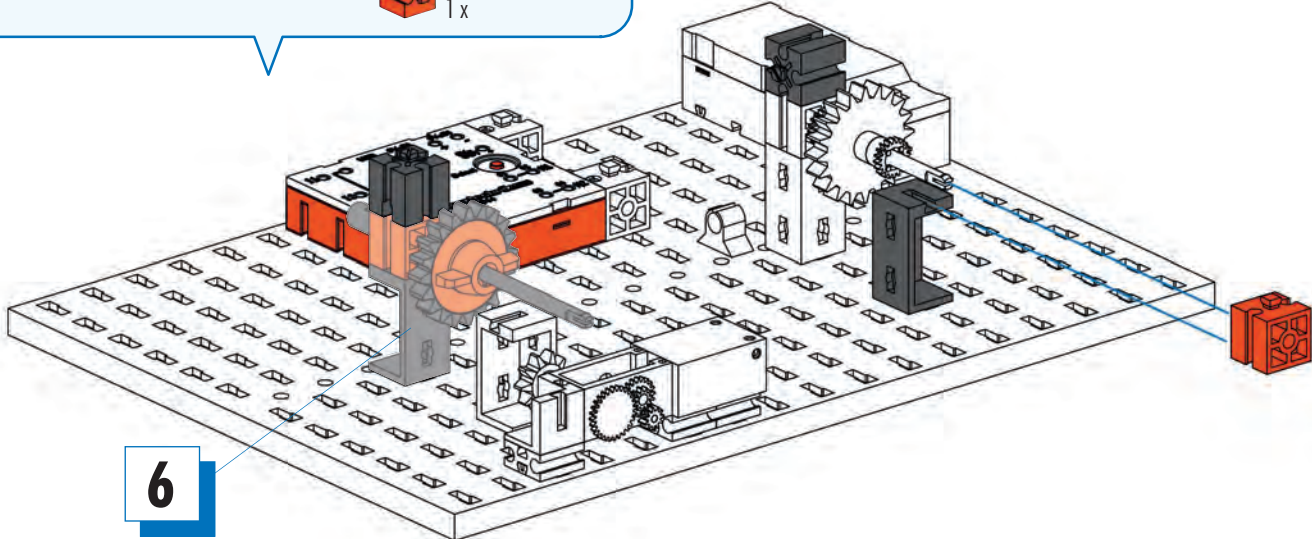

- 6**  1x  1x  1x  90  1x  1x  2x  1x  1x
- 90 mm

- 7**  1x  2x  1x  1x



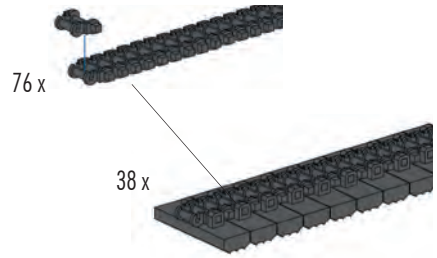

8  76 x  38 x

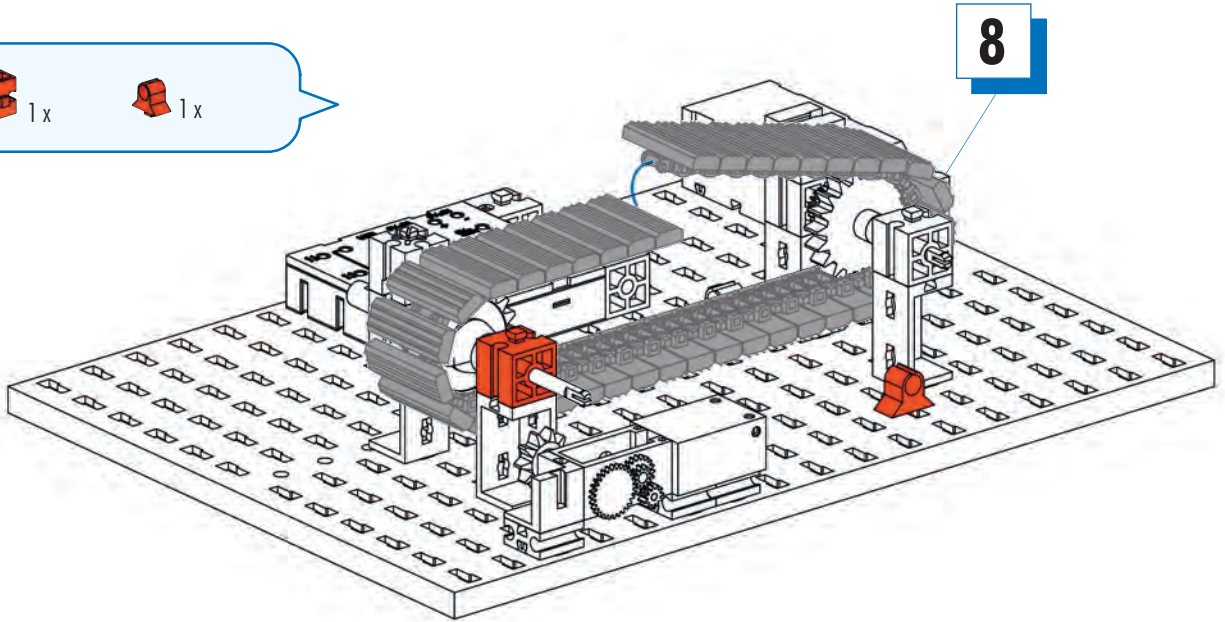

9  1 x  1 x

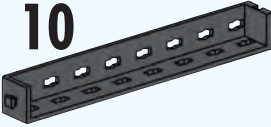

10  2 x  2 x  4 x

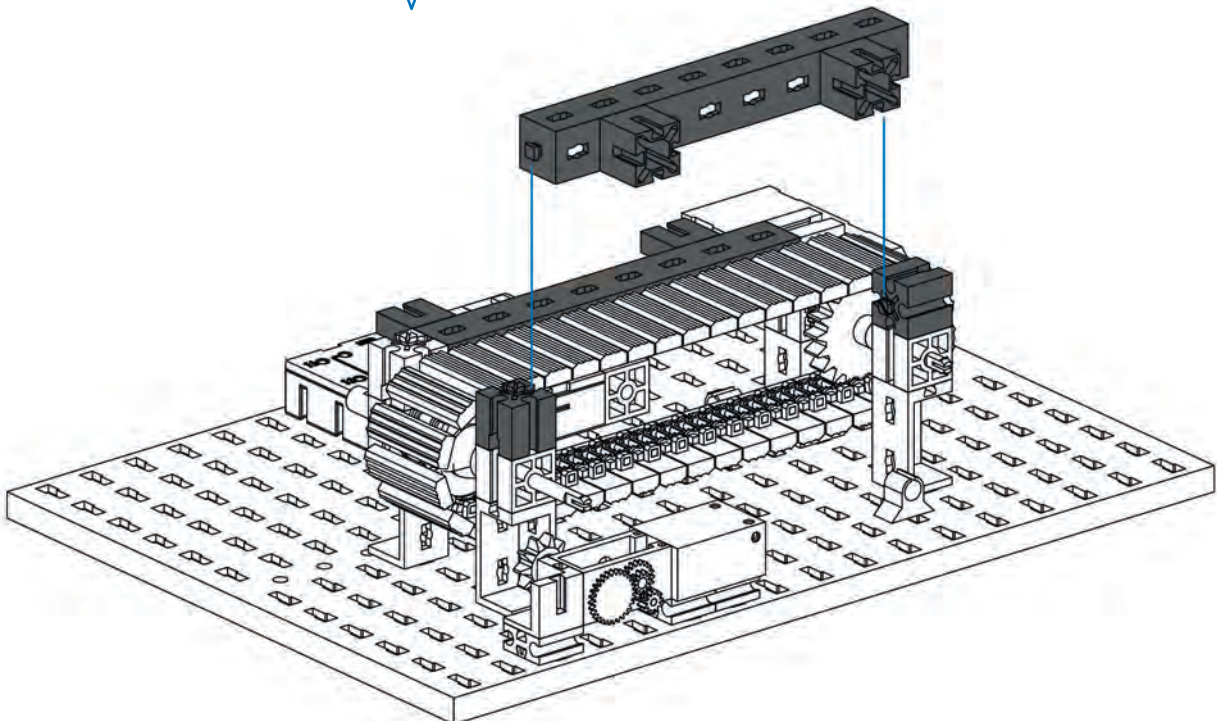

- 11**
- 2x (dark grey Technic beam)
 - 2x (dark grey Technic beam)
 - 2x (red Technic L-shaped connector)
 - 1x (red Technic L-shaped connector)
 - 4x (red Technic pin)
 - 1x (red Technic bush)
 - 1x (red Technic bush)
 - 1x (black Technic gear)

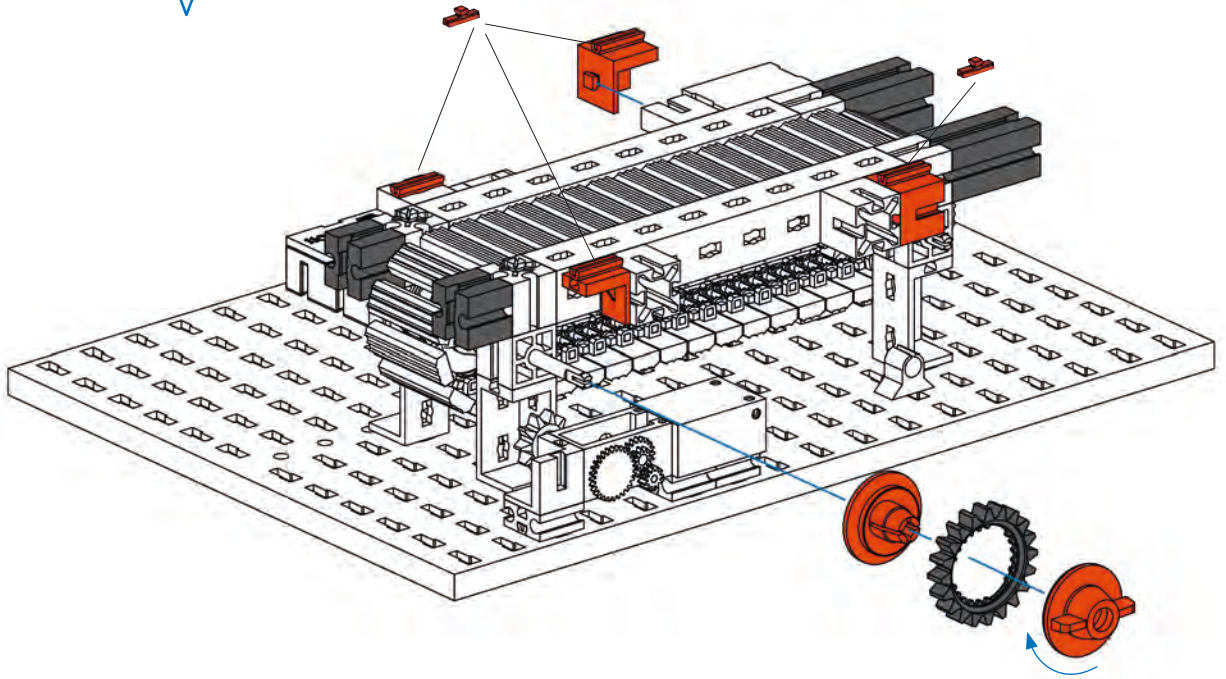

- 12**
- 2x (red Technic beam 30)
 - 4x (red Technic beam)
 - 2x (yellow Technic connector)
 - 2x (black Technic connector with L-shaped hole)
 - 1x (red Technic beam with 4 holes)
 - 1x (black Technic connector)
 - 1x (red Technic pin)

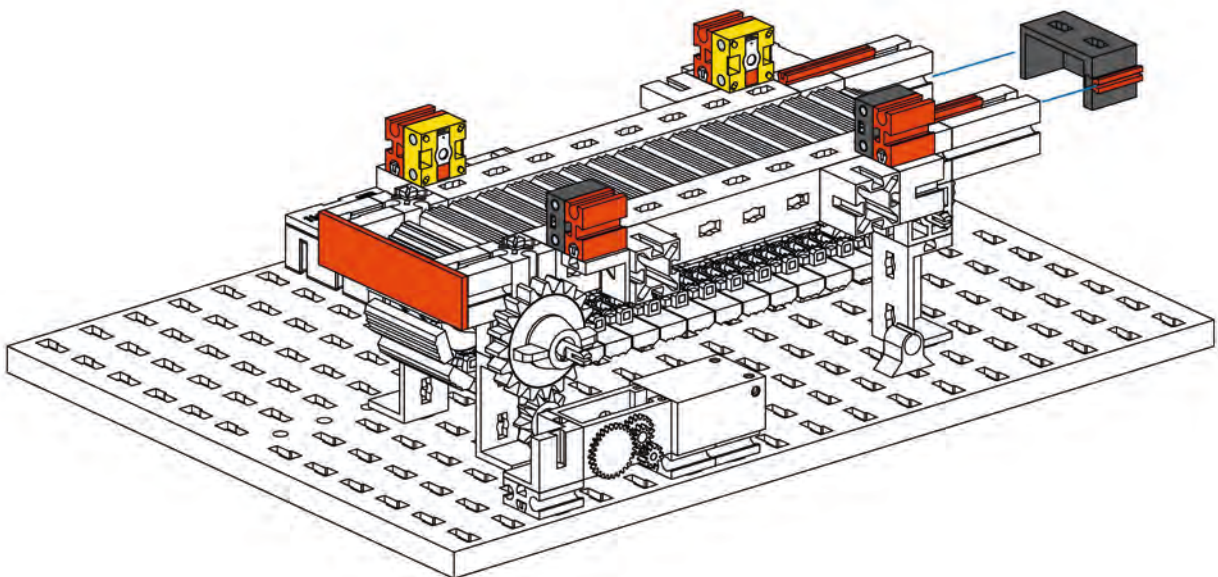

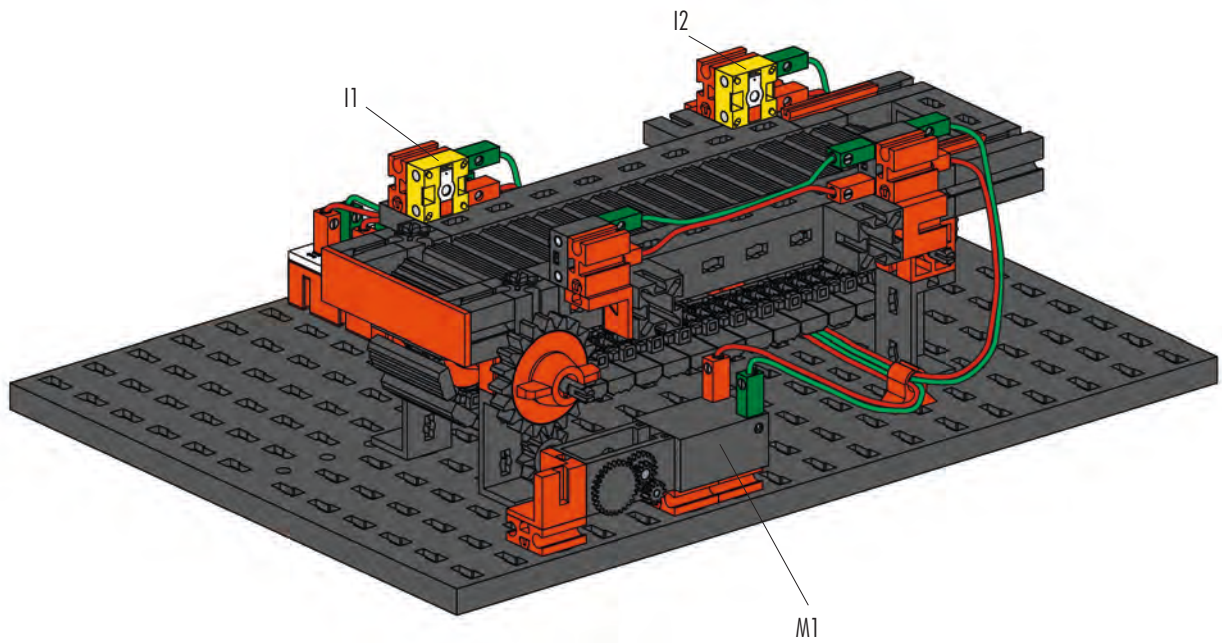

Schaltplan
Circuit diagram
Plan électrique

Schakelschema
Diagrama de circuitos
Plano elétrico de ligação

Schema elettrico
Схема подключения
电路图

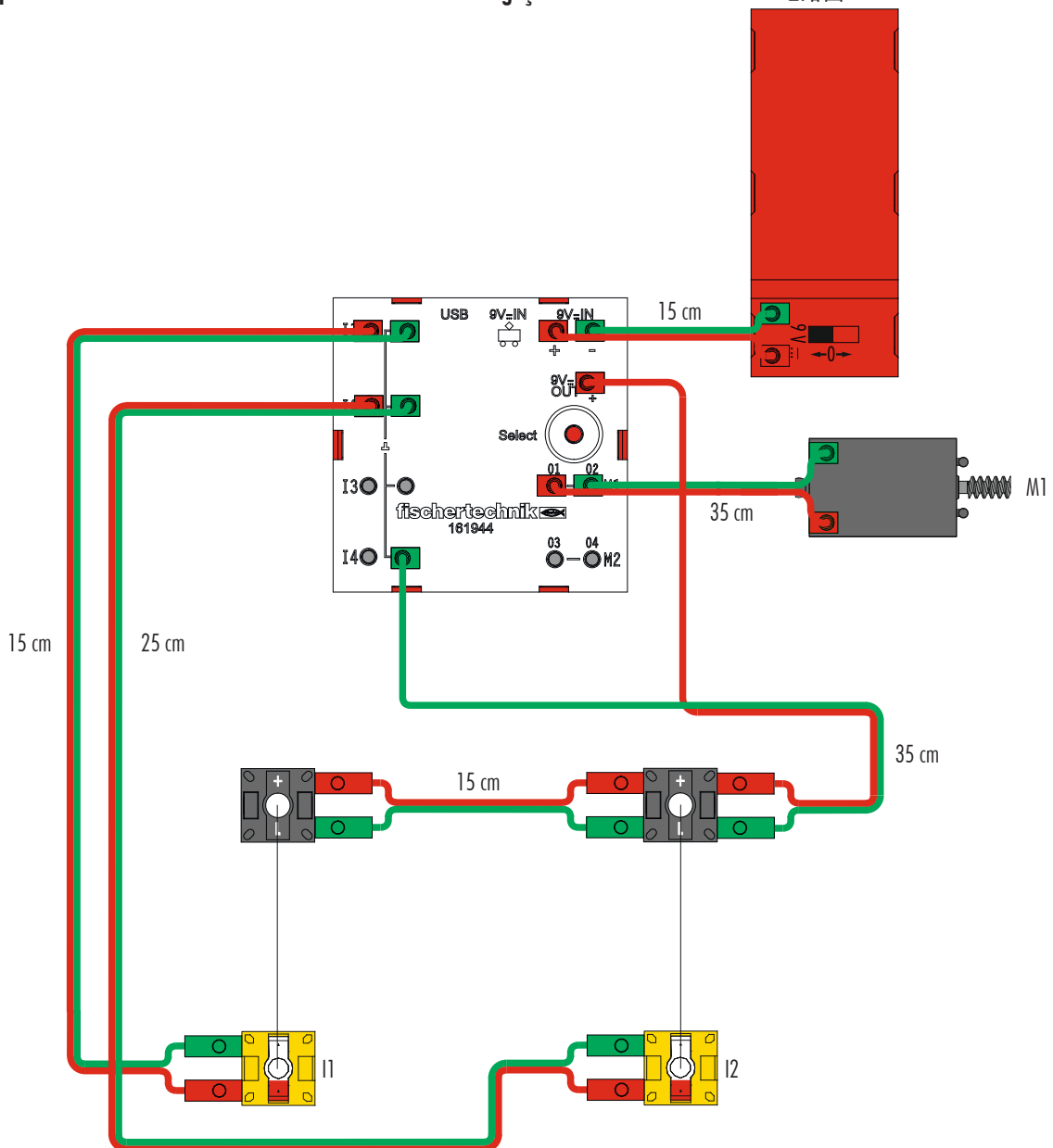

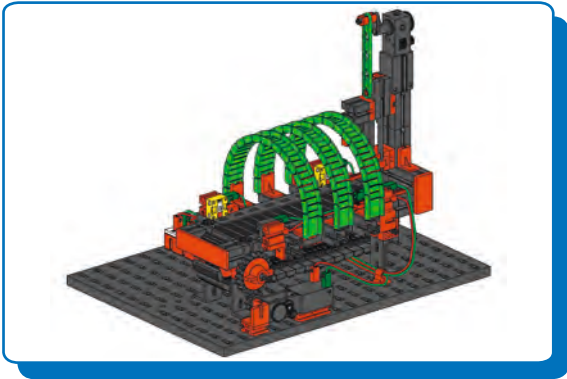

Förderband mit Stanze
 Conveyor belt with punch
 Bande transporteuse avec
 poinçon

Transportband met stans
 Cinta transportadora con
 punzonadora
 Correia transportadora
 com punção

Nastro trasportatore con
 punzonatrice
 Ленточный транспортер
 со штамповочным прессом
 带冲压机的输送带

1-13

Seite 40
 Page 40
 Page 40
 Bladzijde 40
 Página 40
 Pagina 40
 Pagina 40
 Страница 40
 页次 40

14

2x 3x
 3x 1x

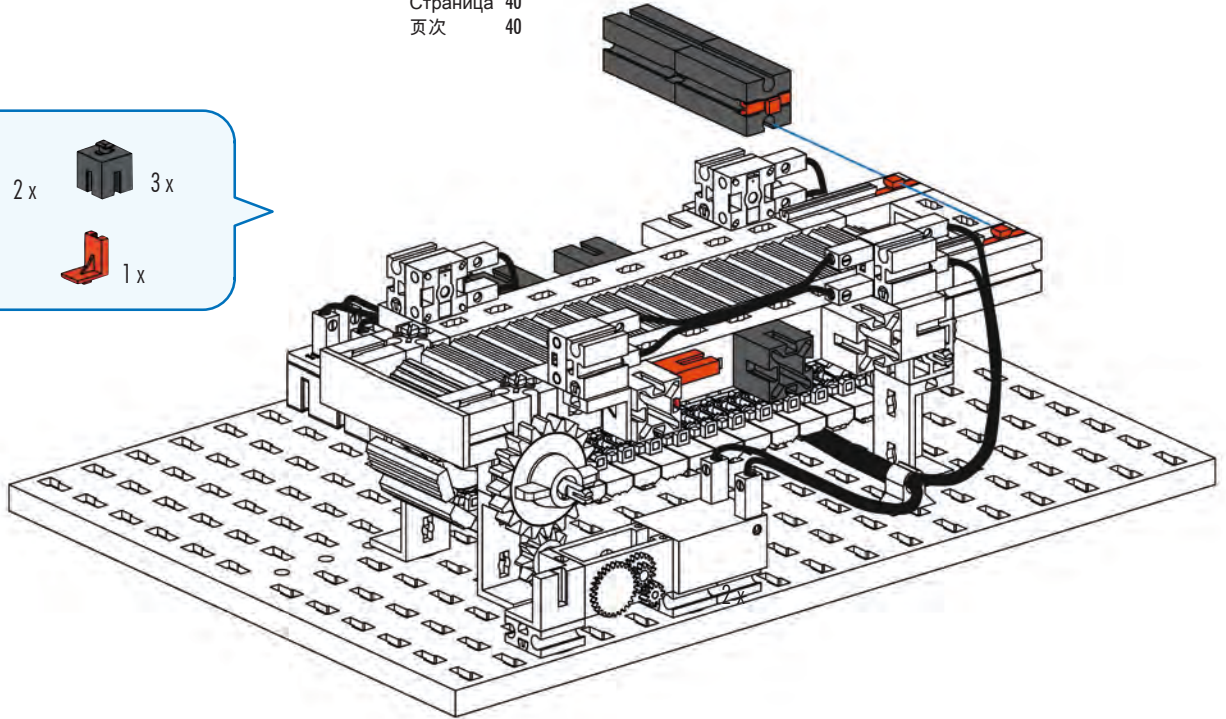

15

1x 8x
 2x

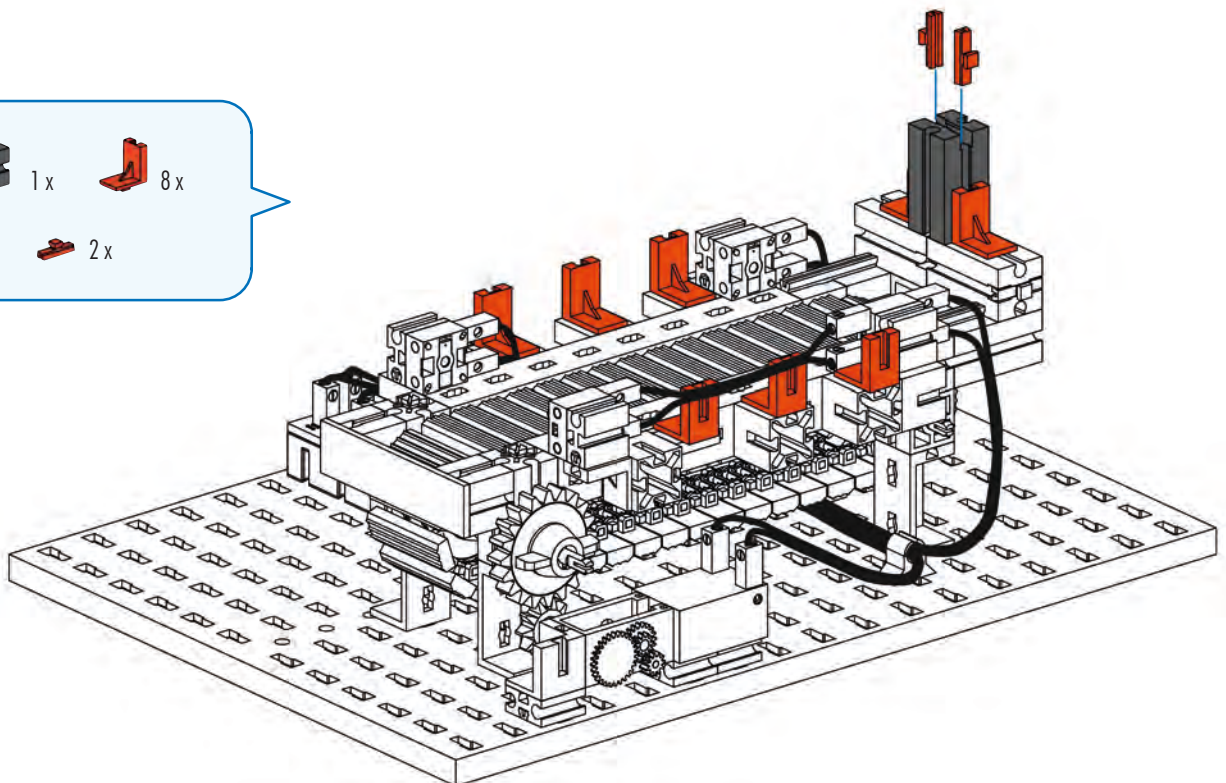

16

- 1x [Grey Technic Beam 1x3]
- 1x [Grey Technic Motor]
- 1x [Grey Technic Motor]
- 1x [Red Technic Pin]
- 1x [Grey Technic Motor]
- 1x [Grey Technic Lever]
- 1x [Grey Technic Pin]
- 2x [Red Technic Pin]

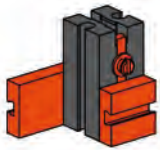
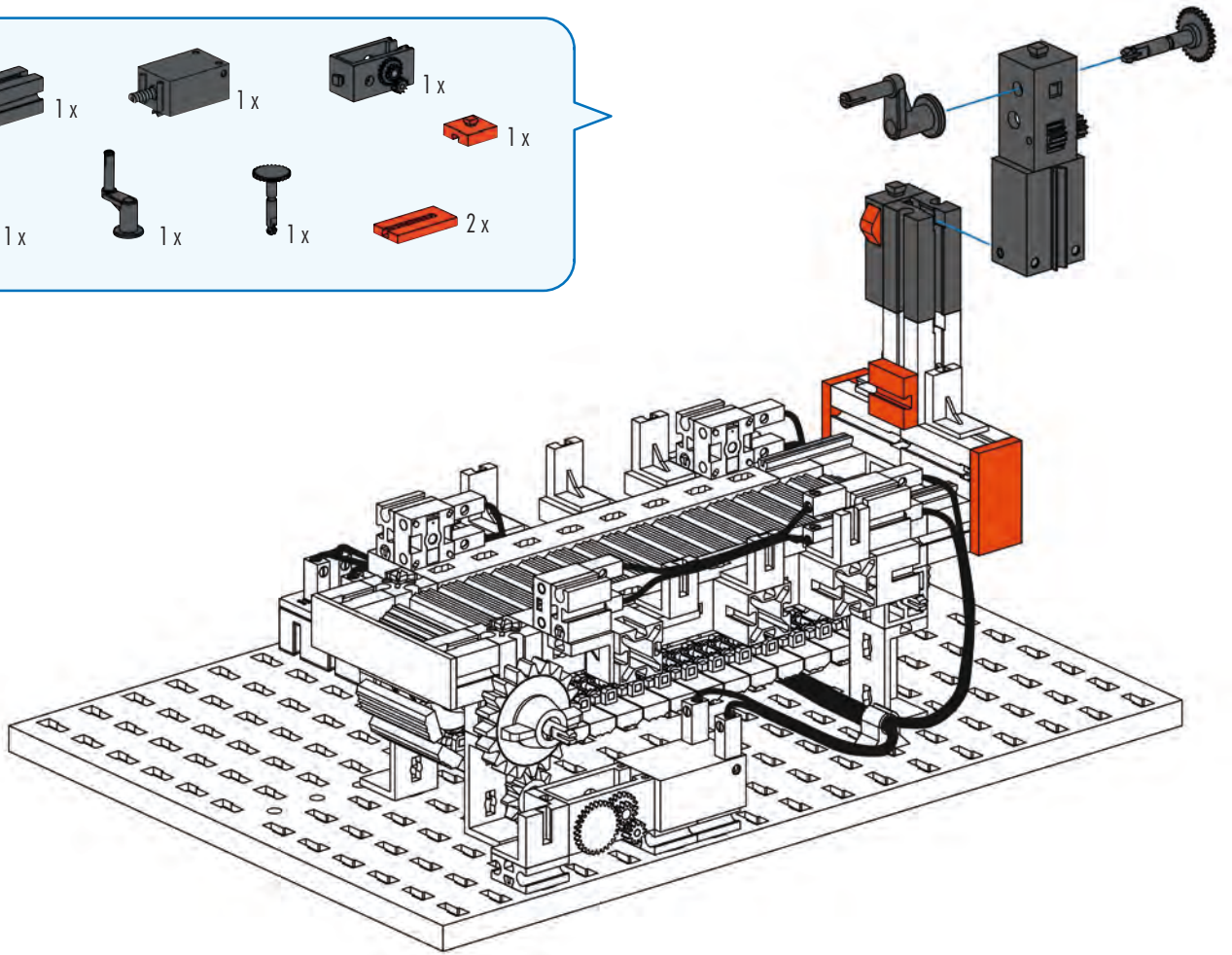

17

- 1x [Grey Technic Beam 1x3]
- 1x [Red Technic Pin]
- 1x [Red Technic Pin]
- 1x [Red Technic Pin]

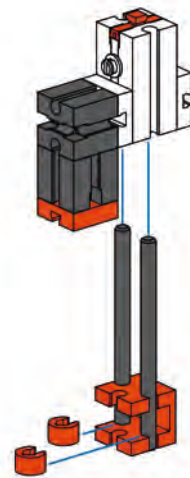

18



- 2x [Grey Technic Beam 1x3]
- 2x [Red Technic Pin]
- 1x [Red Technic Pin]
- 2x [Grey Technic Pin 60]
- 1x [Red Technic Pin]
- 1x [Red Technic Pin]

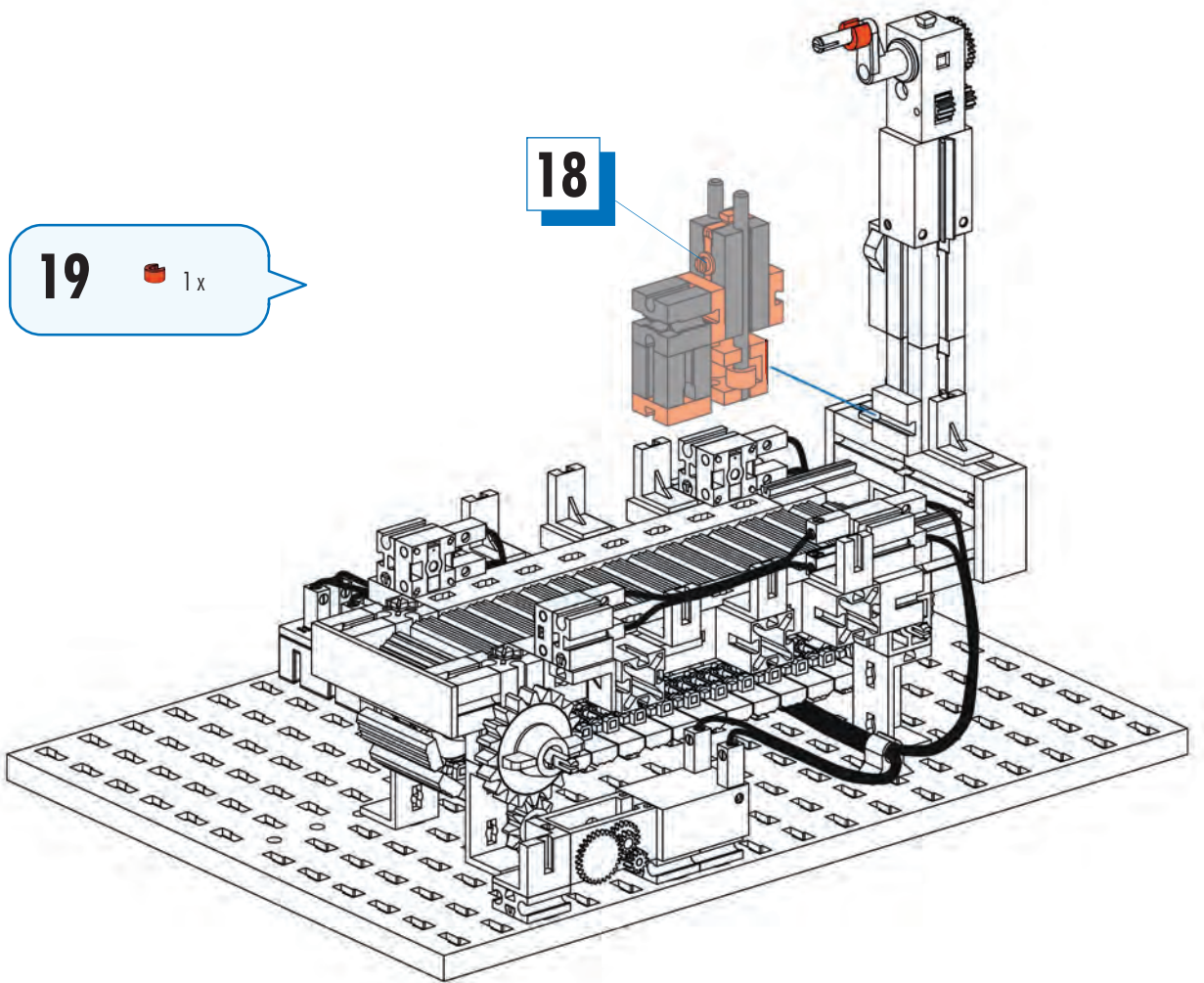

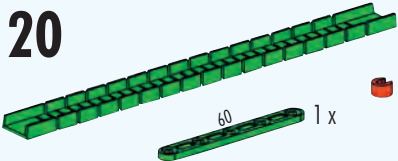

19  1x

18

20  3x
 1x

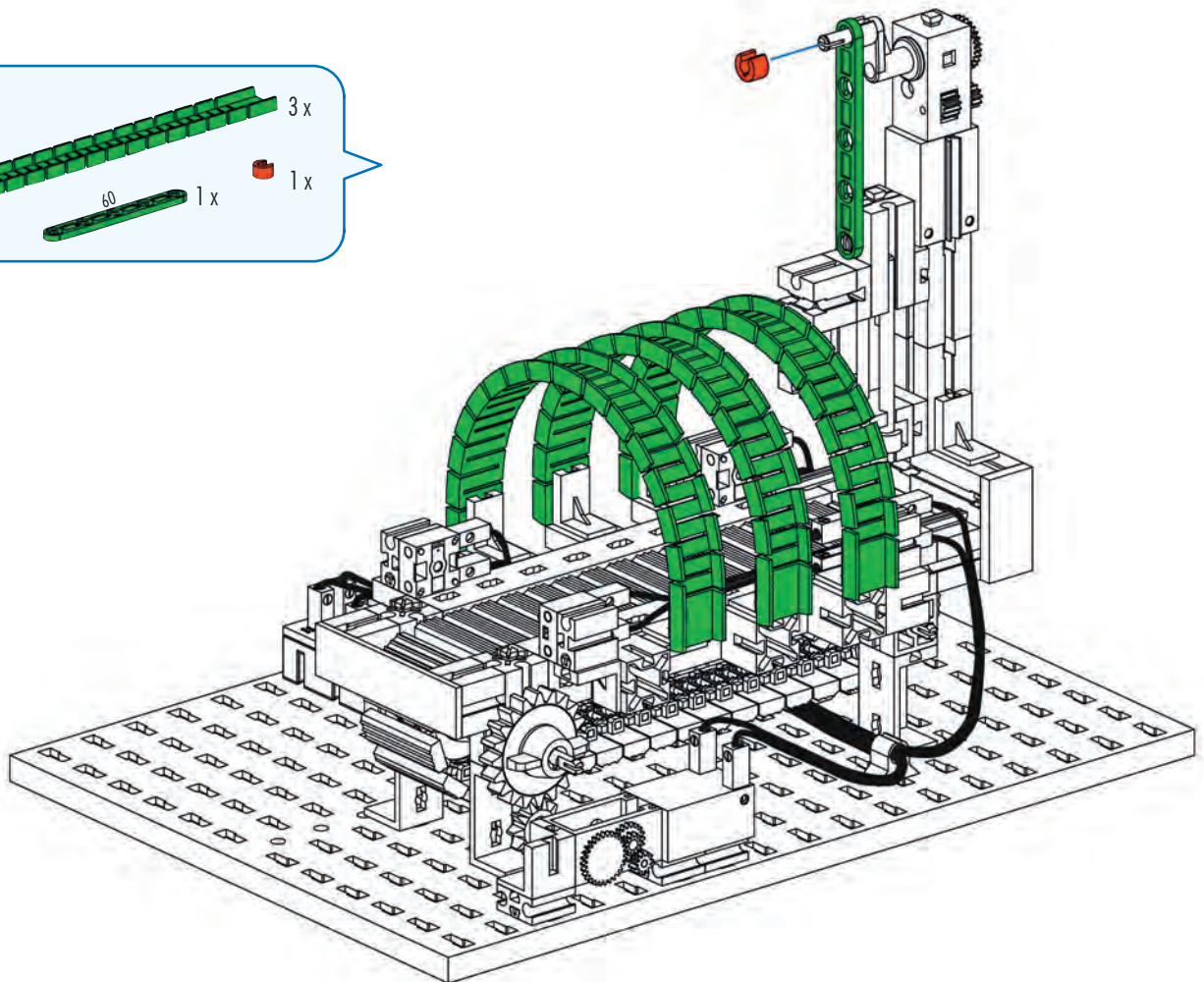

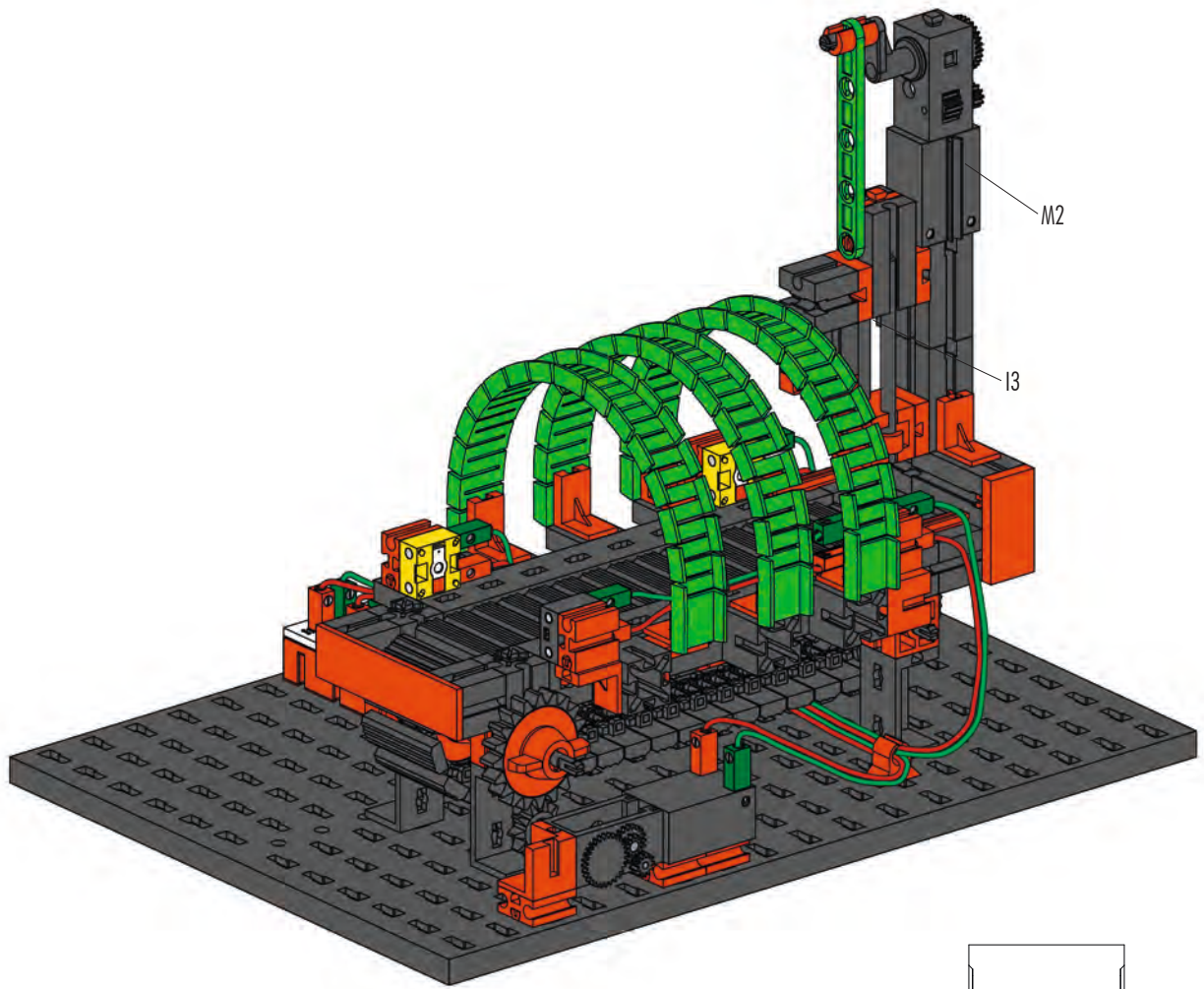



Schaltplan
Circuit diagram
Plan électrique

Schakelschema
Diagrama de circuitos
Plano elétrico de ligação

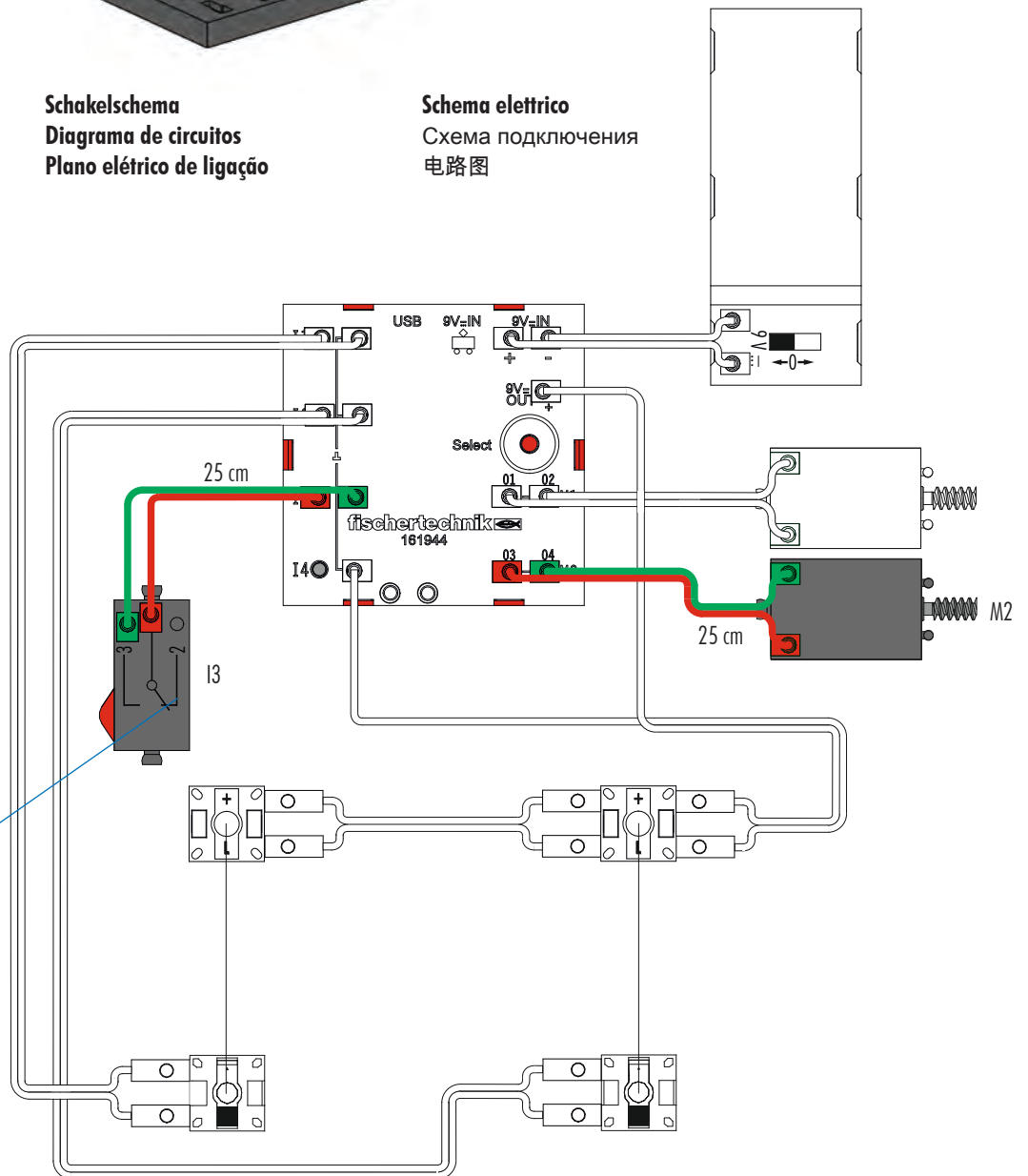
Schema elettrico
Схема подключения
电路图



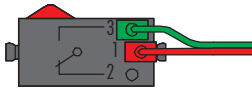

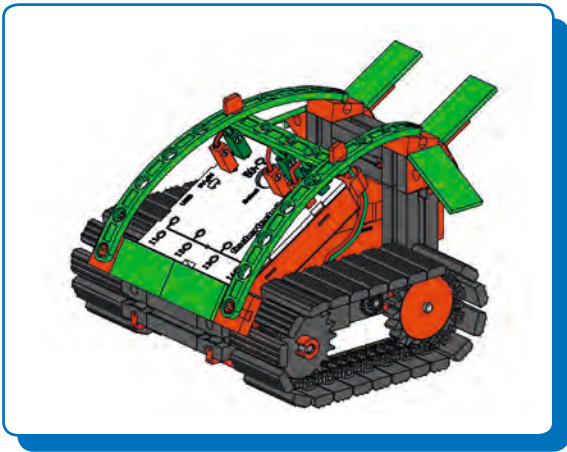

Anschlüsse 1 und 3 verwenden!
Use connections 1 and 3!
Utiliser les raccordements 1 et 3 !
Aansluitingen 1 en 3 gebruiken!
¡Emplear conexiones 1 y 3!
Utilizar as conexões 1 e 3!
Usare le connessioni 1 e 3!
Используйте контакты 1 и 3!
请使用接头 1 和 3 !







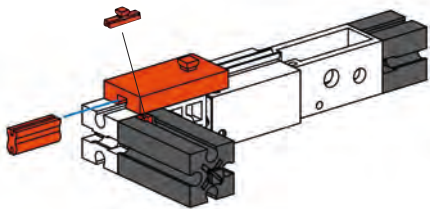
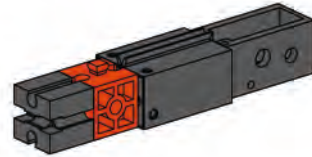

Fahrroboter
Mobile robot
Véhicule robot

Rijrobot
Robot desplazable
Robô condutor





Robot mobile
Робот-автомобиль
机器人车

1  1x  1x  1x  1x

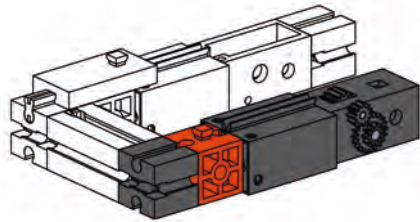





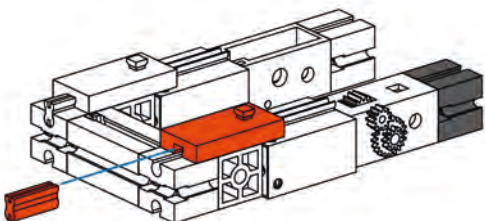

2  1x  1x  1x  1x  1x





3  1x  1x
 1x  1x



4  1x  1x  1x

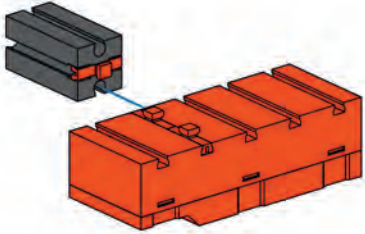
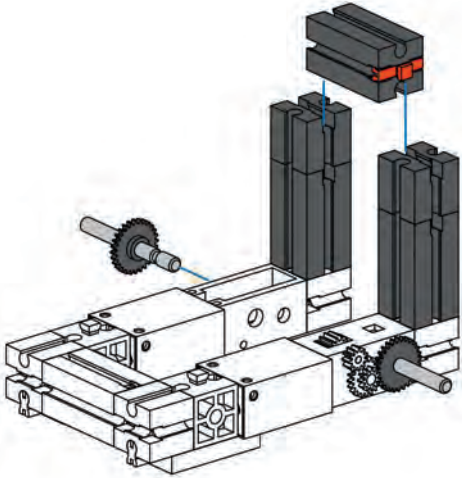

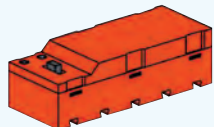
- 5**  3x  2x  1x  2x



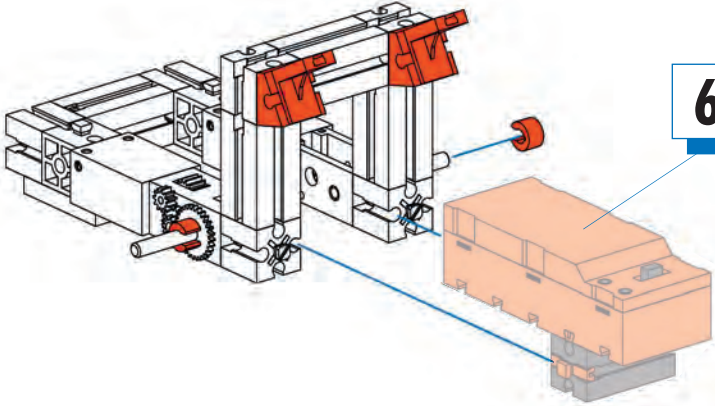





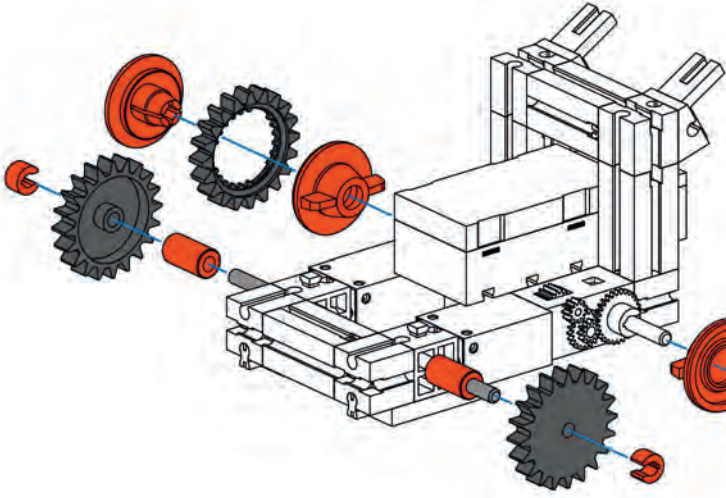
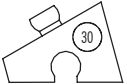

- 6**  1x  1x  3x



6

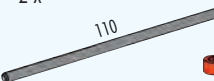

- 7**  2x  2x  2x



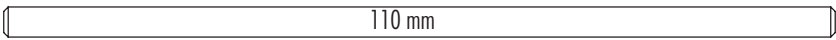

- 8**  2x  2x  2x  2x  2x  1x  2x





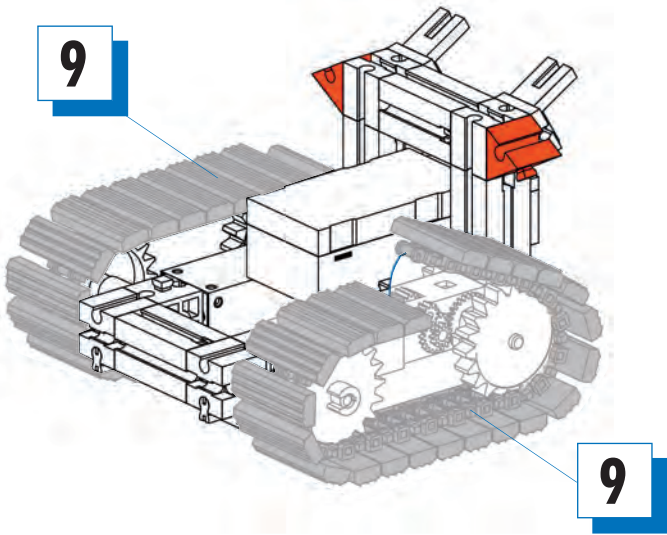

9  90 x  44 x

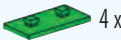

45 x  **2 x**
22 x 

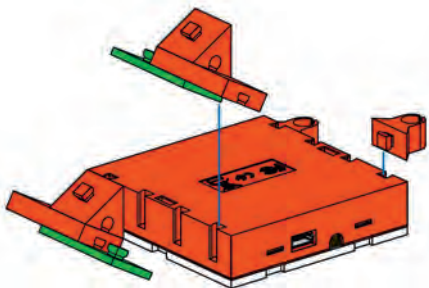
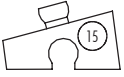
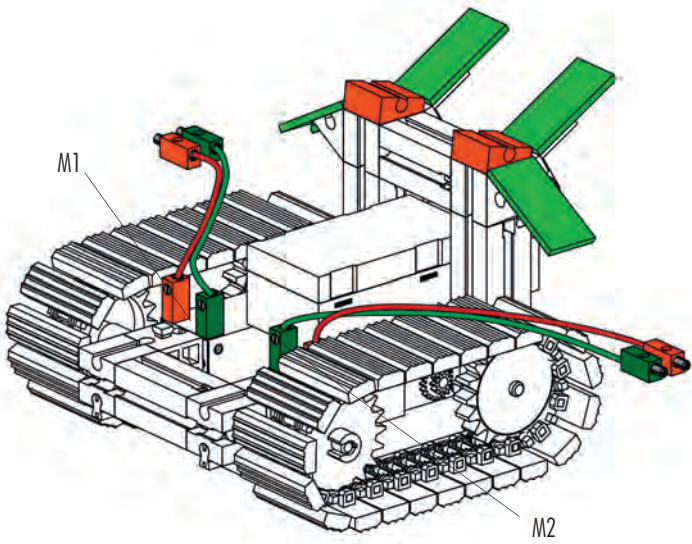

10  60° 2 x

11  4 x  15° 2 x
15 cm   2 x

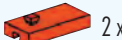
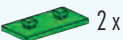

12  1 x  2 x  2 x
 60° 2 x  2 x

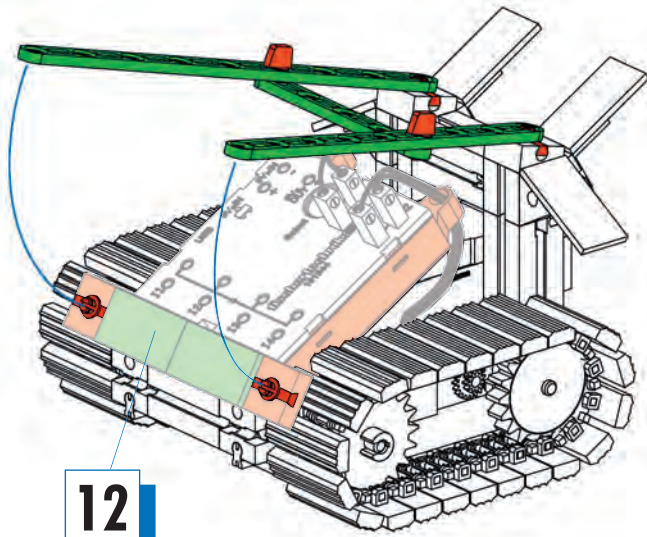

12

13

	1 x		2 x
	2 x		4 x

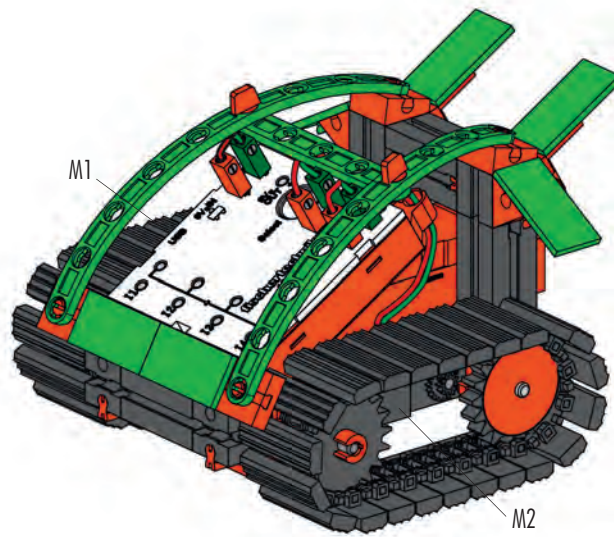

Schaltplan
Circuit diagram
Plan électrique

Schakelschema
Diagrama de circuitos
Plano elétrico de ligação

Schema elettrico
Схема подключения
电路图

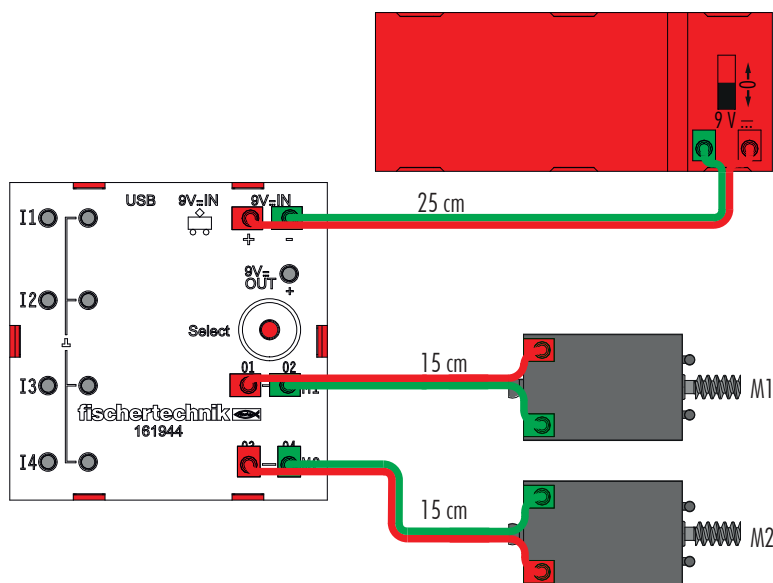



Hinderniserkenner
Hindrance detector
Détecteur
d'obstacles

Obstakeldetector
Detector de obstáculos
Identificador de
obstáculos

Rilevatore di ostacoli
Обнаружитель
препятствий
障碍物识别车

1-11

Seite 49
 Page 49
 Page 49
 Bladzijde 49
 Página 49
 Pagina 49
 Pagina 49
 Страница 49
 页次 49

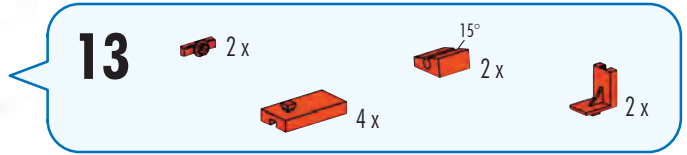
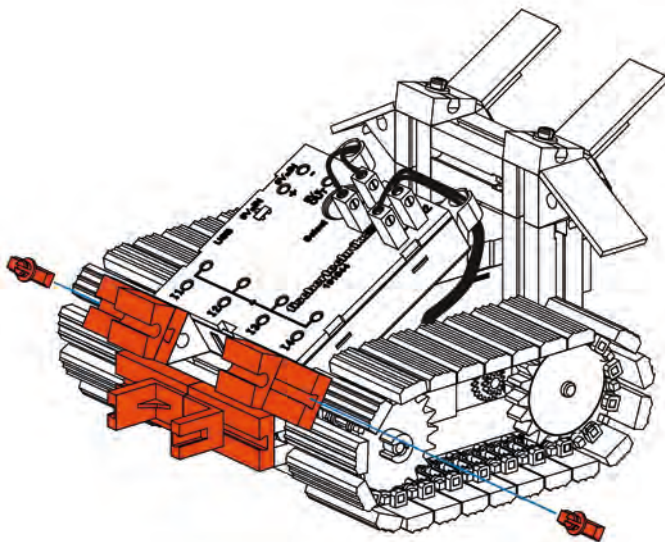
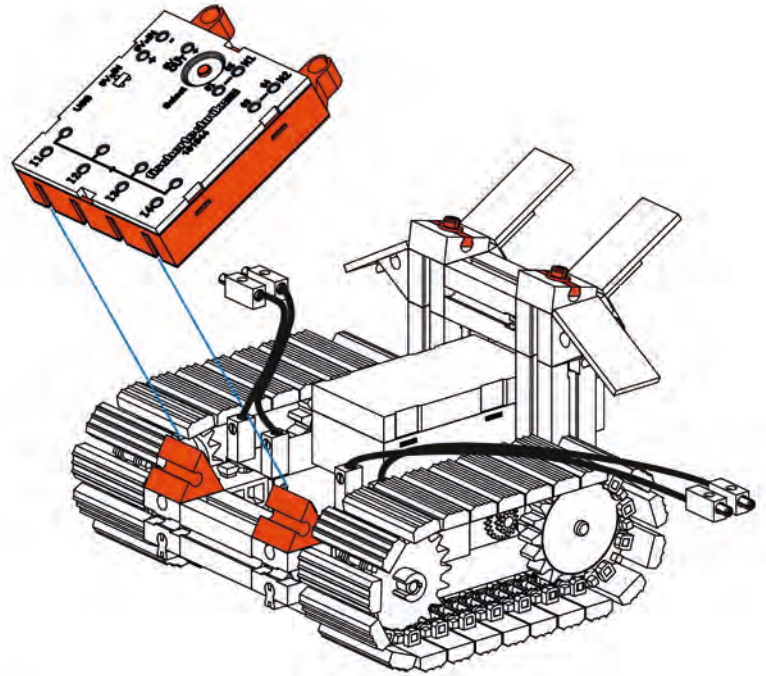
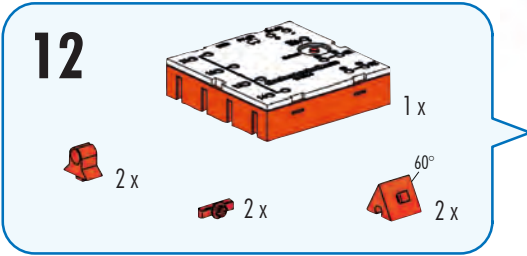

Schaltplan
Circuit diagram
Plan électrique

Schakelschema
Diagrama de circuitos
Plano elétrico de ligação

Schema elettrico
Схема подключения
电路图

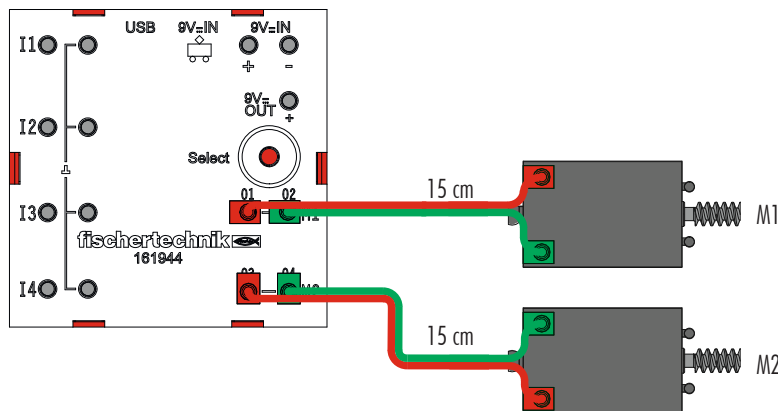

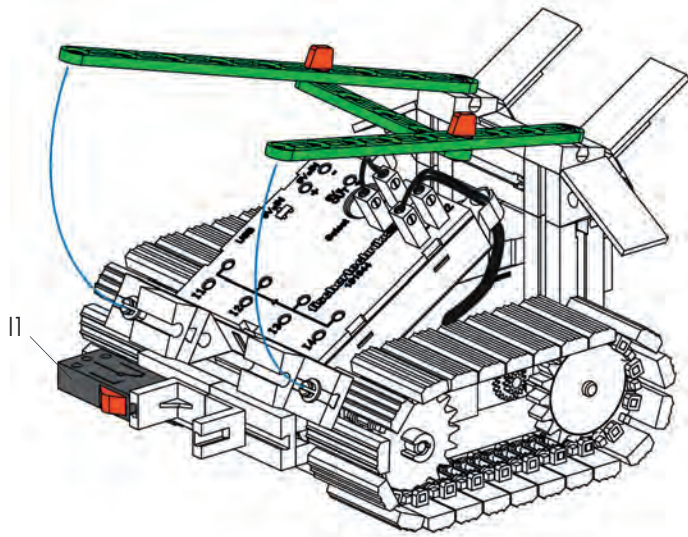

14

- 60 1x
- 120 2x
- 1x
- 4 2x

15

- 1x
- 1x
- 15° 1x
- 1x
- 1x
- 1x

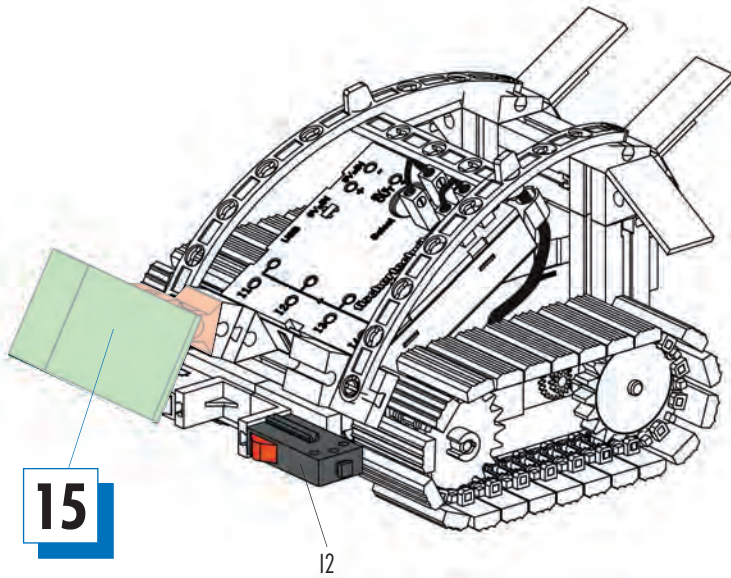
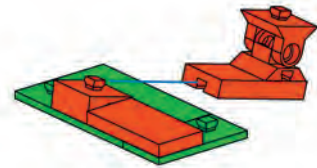

15

16

- 1x

17

- 1x
- 1x
- 15° 1x
- 1x
- 1x
- 1x

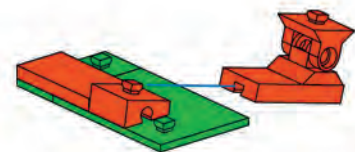

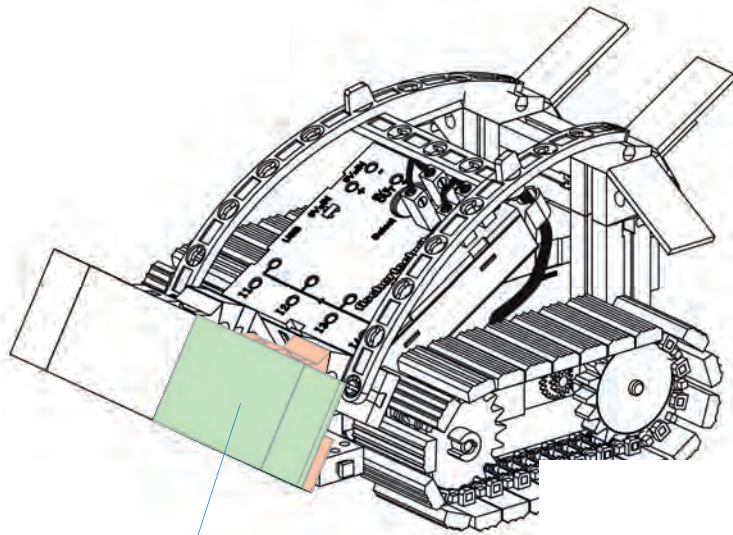

17

18

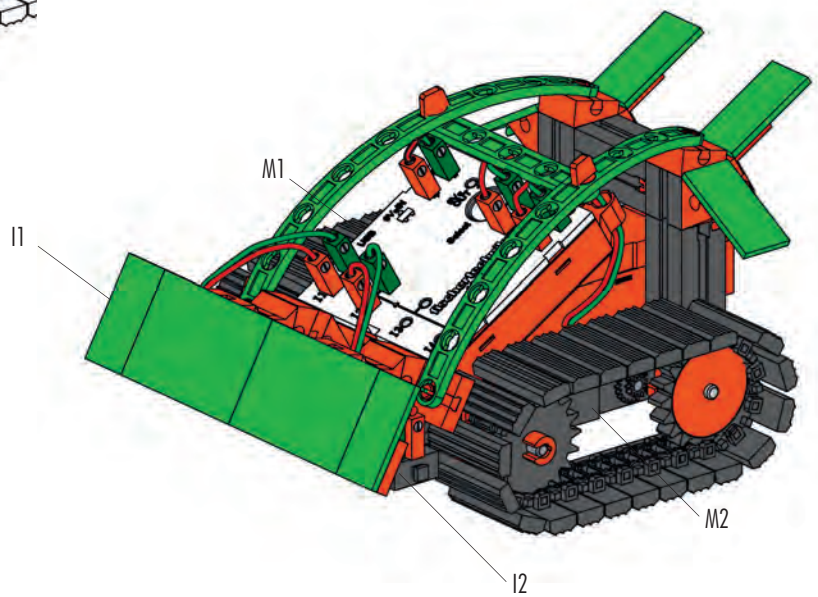

Schaltplan
Circuit diagram
Plan électrique

Schakelschema
Diagrama de circuitos
Plano elétrico de ligação

Schema elettrico
Схема подключения
电路图

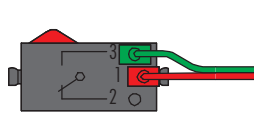
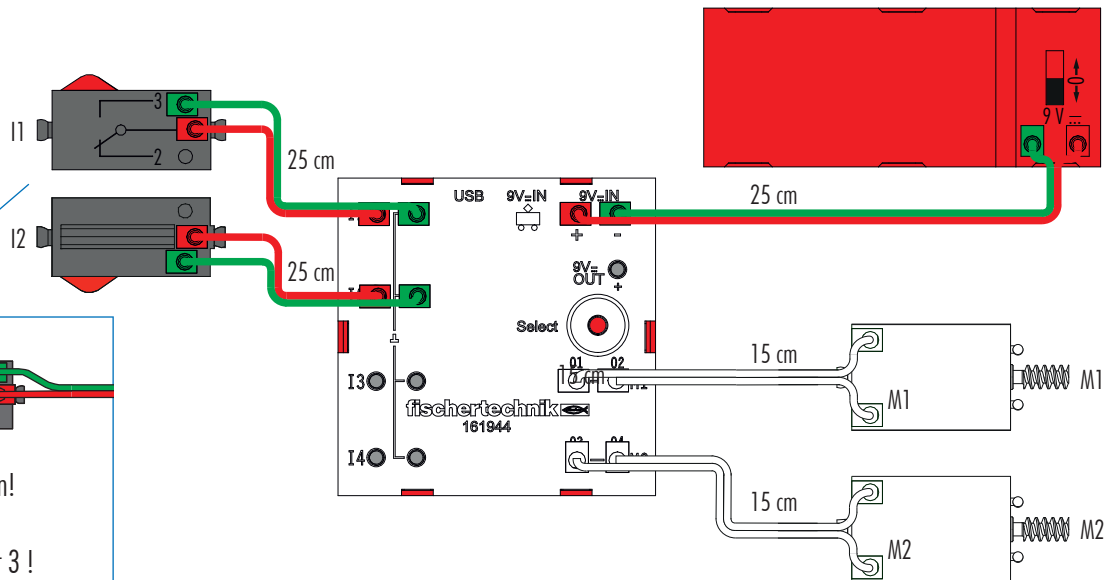

Anschlüsse 1 und 3 verwenden!
Use connections 1 and 3!
Utiliser les raccordements 1 et 3!
Aansluitingen 1 en 3 gebruiken!
¡Emplear conexiones 1 y 3!
Utilizar as conexões 1 e 3!
Usare le connessioni 1 e 3!
Используйте контакты 1 и 3!
请使用接头 1 和 3!

Stromversorgung
Power supply
Alimentation électrique

Stroomvoorziening
Alimentación de corriente
Alimentação elétrica

Alimentazione
Электропитание
电源供应装置

ACCU SET
34 969

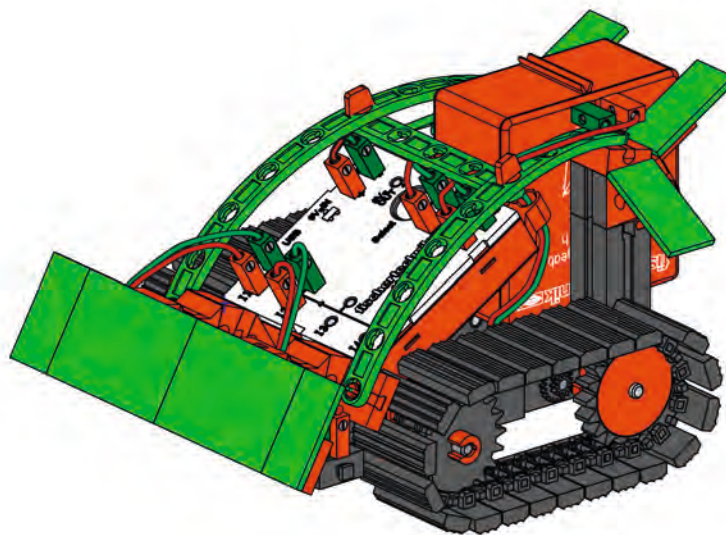
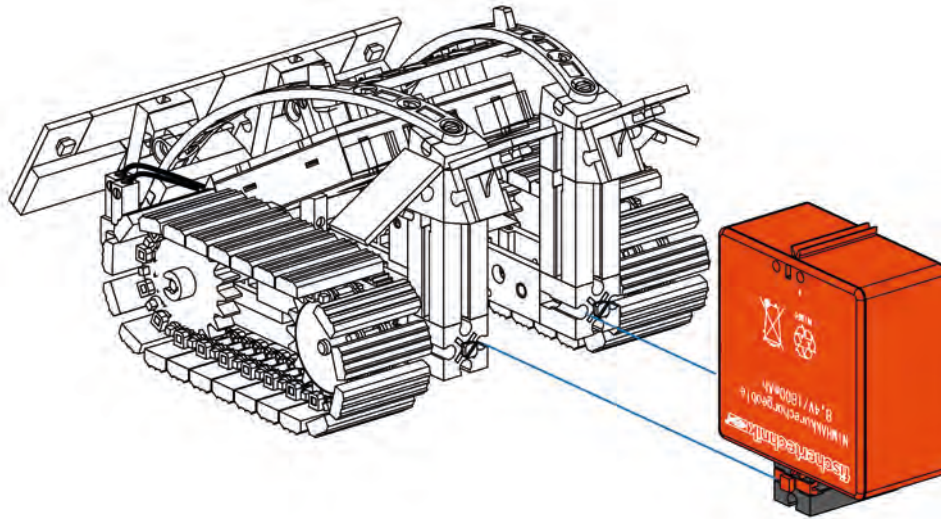
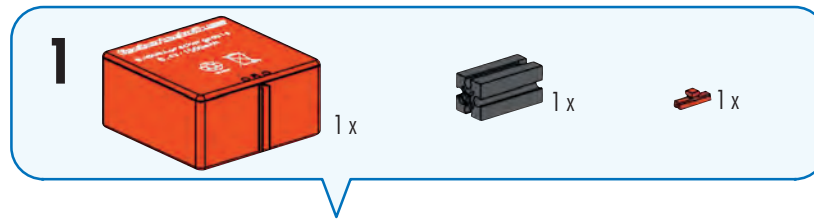

Empfohlene Aufbewahrung:	3 x Aufbewahrungssystem Art.-Nr. 94828
Recommended storage:	3 x storage system Art No. 94828
Stockage conseillé :	3 x système de stockage Art n° 94828
Bewaarsadvies:	3 x bewaarsysteem art.-nr. 94828
Consejos para guardar el producto:	3 x almacenamiento Art. Nº 94828
Conservação recomendada:	3 x sistema de conservação n.º de art. 94828
Conservazione consigliata:	3 sistemi di conservazione, cod. prod. 94828
Рекомендуемое хранение:	3 x бокса для хранения. Арт.№ 94 828
推荐的保存方式 :	3 个产品号为 94 828 的保存系统

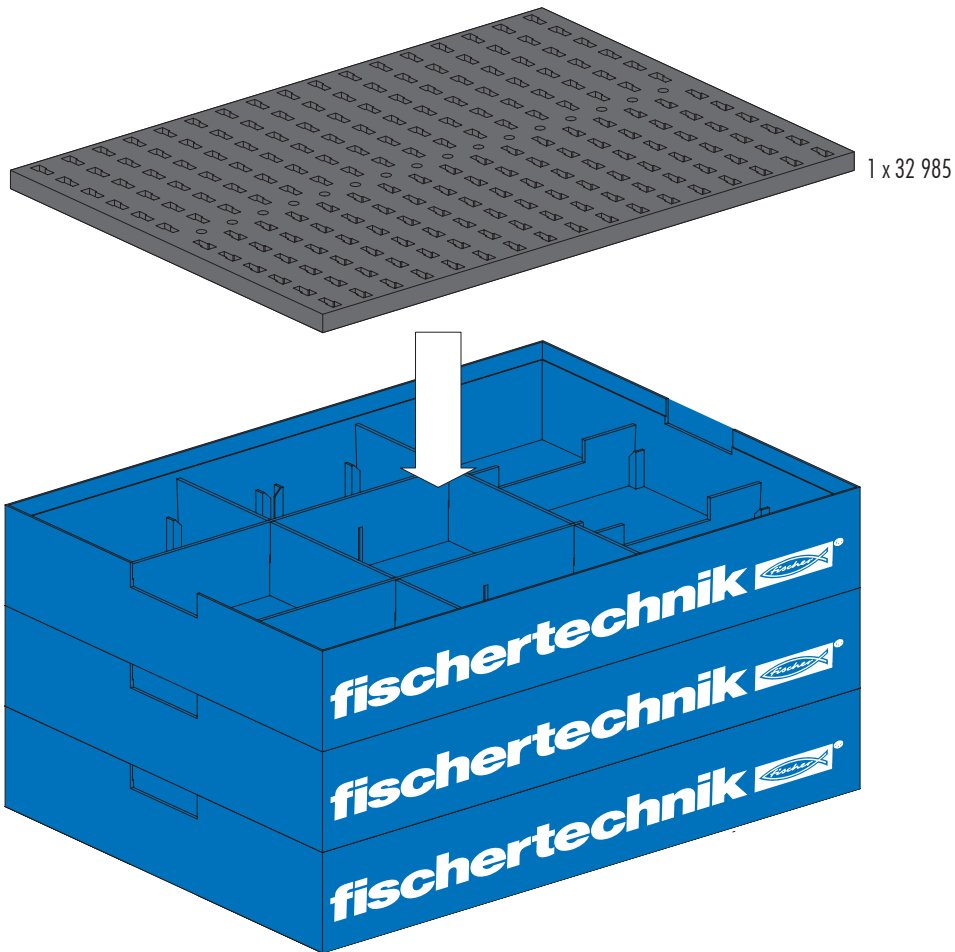

Sortiervorschlag / Storage suggestion / Suggestion de classement / Sorteervoorstel / Propuesta de clasificación / Proposta de divisão / Proposta di sistemazione / Рекомендации по сортировке / 保存系统的分类建议:

www.fischertechnik.de/Sortiervorschläge



Hinweise zum Umweltschutz / Instructions for Environmental Protection / Remarques de protection de l'environnement / Bescherming van het milieu / Notas con respecto a la protección del medio ambiente / Instruções para a proteção do meio ambiente / Indicazioni sulla tutela ambientale / Указания по охране окружающей среды / 有关环保的提示 :

www.fischertechnik.de/environment

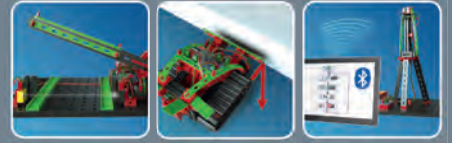

fischertechnik 

ROBOTICS

fischertechnik GmbH
Klaus-Fischer-Str. 1
72178 Waldachtal
Germany

Phone: +49 74 43/12-43 69
Fax: +49 74 43/12-45 91

info@fischertechnik.de
www.fischertechnik.de

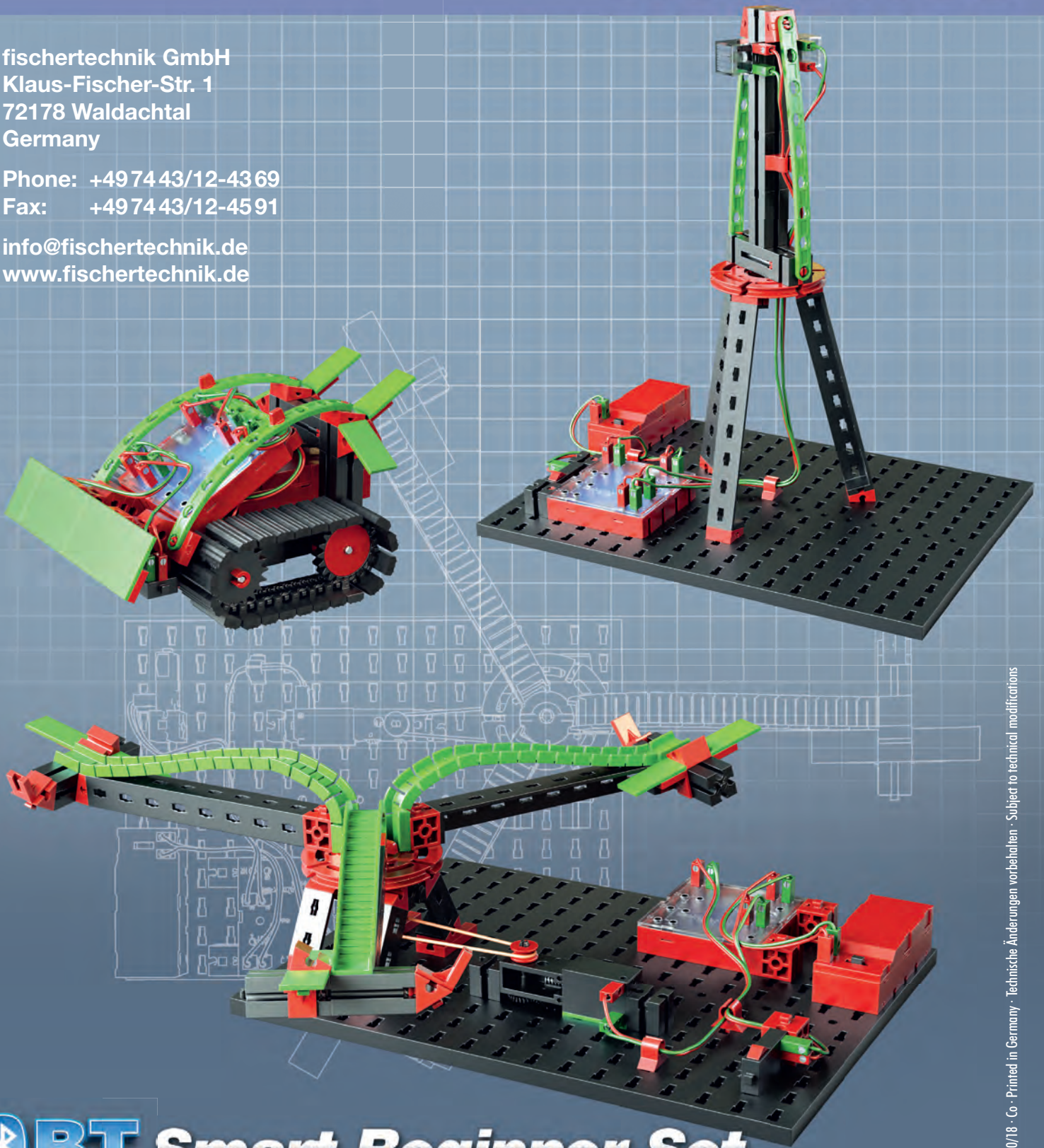

 **BT Smart Beginner Set**
Robotics  **BT Beginner**

12 MODELS