

GARMIN®

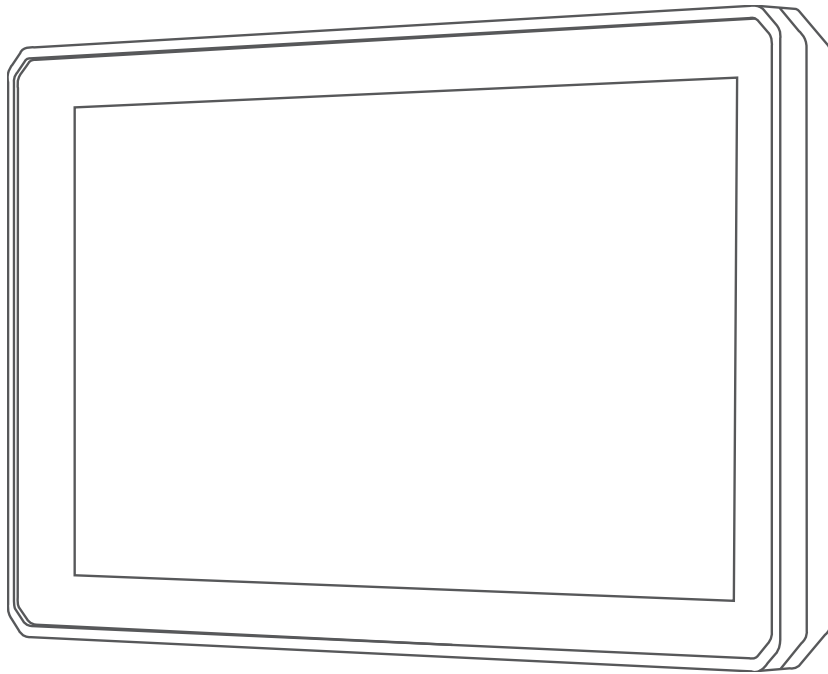

ZŪMO® XT

Owner's manual

© 2021 Garmin Ltd. or its subsidiaries

All rights reserved. Under the copyright laws, this manual may not be copied, in whole or in part, without the written consent of Garmin. Garmin reserves the right to change or improve its products and to make changes in the content of this manual without obligation to notify any person or organisation of such changes or improvements. Go to www.garmin.com for current updates and additional information concerning the use of this product.

Garmin®, the Garmin logo, zūmo®, inReach® and TracBack® are trademarks of Garmin Ltd. or its subsidiaries, registered in the U.S. and other countries. BaseCamp™, Garmin Adventurous Routing™, Garmin Drive™, Garmin Explore™, Garmin Express™, Garmin PowerSwitch™ and myTrends™ are trademarks of Garmin Ltd. or its subsidiaries. These trademarks may not be used without the express permission of Garmin.

Android™ is a trademark of Google LLC. Apple® and Mac® are trademarks of Apple Inc., registered in the U.S. and other countries. The BLUETOOTH® word mark and logos are owned by the Bluetooth SIG, Inc., and any use of such name by Garmin is under licence. Foursquare® is a trademark of Foursquare Labs, Inc. in the U.S. and in other countries. HISTORY® and the H logo are trademarks of A+E Networks and are protected in the United States and other countries around the globe. All Rights Reserved. Used with Permission. microSD® and the microSD logo are trademarks of SD-3C, LLC. Tripadvisor® is a registered trademark of Tripadvisor LLC. Windows® is a registered trademark of Microsoft Corporation in the United States and other countries. Wi-Fi® is a registered trademark of Wi-Fi Alliance. Other trademarks and trade names are those of their respective owners.

Table of contents

Getting started.....	1	Navigating to your destination.....	14
Device Overview	1	Routes	14
Turning the device on or off.....	1	Starting a route.....	14
Acquiring GPS signals.....	2	Taking a Route Using Garmin	
Status bar icons.....	2	Adventurous Routing™	14
Using the on-screen buttons.....	2	Changing the route calculation	
Adjusting the volume.....	3	mode.....	14
Using the audio mixer	3	Starting a route by using the map....	15
Adjusting the screen brightness.....	3	Going home.....	15
Transportation modes.....	3	Your route on the map.....	15
Choosing a Transportation Mode.....	3	Active lane guidance.....	16
Using the Large Button Keyboard.....	3	Viewing turns and directions.....	17
		Viewing the Entire Route on the	
		Map.....	17
		Arriving at your destination.....	17
		Parking Near Your Destination.....	17
		Changing Your Active Route.....	18
		Adding a location to your route.....	18
		Shaping Your Route.....	18
		Taking a detour.....	18
		Stopping the route.....	18
		Avoiding Delays, Tolls and Areas.....	19
		Avoiding traffic delays on your	
		route.....	19
		Avoiding toll roads.....	19
		Avoiding toll stickers.....	19
		Avoiding road features.....	19
		Custom Avoidances.....	19
		Navigating off road.....	20
		Fuel tracking.....	20
		Enabling fuel tracking.....	21
		Setting a low-fuel warning.....	21
		Resetting the Fuel Tank Mileage.....	21
		Enabling dynamic fuel stops.....	21
Installation.....	4	Finding and saving locations.....	21
Mounting your device in a		Finding a location using the search	
motorcycle.....	4	bar.....	22
Powered Motorcycle Mount.....	4	Points of Interest.....	22
Installing the Handlebar Base.....	4	Finding a location by category.....	22
Attaching the Power Cables to the		Navigating to points of interest within	
Motorcycle Mount.....	6	a venue.....	22
Attaching the Base Plate to the		Viewing Your Garmin Explore™ Points	
Motorcycle Mount.....	7	of Interest.....	23
Attaching the Base Plate to the		Synchronising Garmin Explore	
Handlebar Base.....	7	Account Data.....	23
Installing your device in the		Location Search Results.....	23
motorcycle mount.....	8		
Removing Your Device from the			
Motorcycle Mount.....	8		
Mounting Your Device in an			
Automobile.....	9		
Rider Awareness Features and			
Alerts.....	10		
Enabling or Disabling Rider Alerts.....	10		
Red light and speed cameras.....	10		
Incident Detection and Notifications...	11		
Setting Up an Incident Contact.....	11		
Cancelling an Incident Notification..	11		
Disabling Incident Notifications.....	12		
inReach Remote.....	12		
Connecting an inReach Device.....	12		
Sending an inReach Message.....	12		
SOS.....	12		
Viewing Helmet Law Notifications.....	13		
Searching for Helmet Laws.....	13		

- Location Search Results on the Map..... 24
- Changing the search area..... 25
- Parking..... 25
 - Finding Parking Near Your Current Location..... 25
 - Finding Parking Near a Specified Location..... 25
 - Understanding Parking Colours and Symbols..... 25
- Search tools..... 26
 - Finding an address..... 26
 - Finding a junction..... 26
 - Finding a location using coordinates..... 26
- Finding HISTORY® points of interest.. 26
- Foursquare..... 26
 - Connecting to your Foursquare account..... 27
 - Searching Foursquare points of interest..... 27
 - Viewing Foursquare location details..... 27
 - Checking in with Foursquare..... 27
- Tripadvisor®..... 27
 - Finding Tripadvisor points of interest..... 27
- Viewing history..... 27
 - Clearing the list of recently found places..... 28
- Viewing current location information.. 28
 - Finding emergency services and fuel..... 28
 - Getting directions to your current location..... 28
- Adding a shortcut..... 28
 - Removing a shortcut..... 28
- Saving Locations..... 28
 - Saving a location..... 28
 - Saving a Location by Using the Map..... 29
 - Saving your current location..... 29
 - Editing a Saved Location..... 29
 - Deleting a favourite location..... 29

Using the Map..... 30

- Map Tools..... 30
 - Viewing a map tool..... 30

- Up ahead..... 31
 - Viewing upcoming locations..... 31
 - Customising the up ahead categories..... 31
- Towns Ahead..... 31
 - Viewing Upcoming Towns and Exit Services..... 31
- Trip information..... 31
 - Viewing trip data from the map..... 31
 - Viewing the trip information page.... 32
 - Resetting trip information..... 32
- Viewing upcoming traffic..... 32
 - Viewing traffic on the map..... 32
 - Searching for traffic incidents..... 32
- Customising the map..... 32
 - Customising the map layers..... 32
 - Changing the map data field..... 33
 - Changing the Map Buttons..... 33
 - Changing the map perspective..... 33

Live services, traffic and smartphone features..... 33

- Bluetooth Feature status icons..... 34
- Pairing Your Phone and Headset..... 34
- Smart Notifications..... 34
 - Receiving notifications..... 35
 - Viewing the list of notifications..... 36
- Hands-free calling..... 36
 - Placing a call..... 36
 - Placing a Call Using Voice Dial..... 36
 - Using in-call options..... 36
- Setting up Bluetooth features for your Apple® device..... 37
 - Disabling Bluetooth features (iPhone®)..... 37
- Setting up Bluetooth features for your smartphone with Android™ 37
 - Disabling Bluetooth features (Android)..... 37
- Disconnecting a Bluetooth device..... 37
- Deleting a paired phone..... 37

Traffic..... 37

- Receiving traffic data using your smartphone..... 38
- Receiving traffic data using a traffic receiver..... 38

Traffic Receiver Subscriptions	38	Discovering Attractions Along Your Trip	48
Viewing traffic on the map	38	Changing routing options for a trip ..	48
Searching for traffic incidents	38	Navigating to a favourite trip	49
Using the apps	39	Sharing a Route	49
Group Ride	39	Tracks	49
Starting a Group Ride	39	Recording Tracks	49
Joining a Group Ride	39	TracBack®	49
Rejoining a Recent Group Ride	39	Following your recent track	49
Adding Riders to a Group Ride	39	Saving your recent track as a trip	49
Broadcasting a Message	40	Logging service history	50
Broadcasting a Location	40	Adding service categories	50
Viewing a Group Ride Notification ..	40	Viewing the Weather Forecast	50
Exiting a Group Ride	40	Viewing weather near a different town	50
Group Ride Settings	40	Viewing the weather radar	50
Radio	41	Viewing weather alerts	50
Selecting a Preset	41	Checking road conditions	51
Selecting a Radio Channel	41	Creating a Round-Trip Route	51
Adjusting the Squelch	41	photoLive traffic cameras	51
Adding a Custom Radio Preset	41	Viewing and Saving photoLive Traffic Cameras	52
Selecting a Roger Tone	41	Viewing photoLive Traffic Cameras on the Map	52
Turning the Radio Off	41	Viewing Previous Routes and Destinations	52
Enabling Push-to-Talk with a Headset	42	zūmo settings	52
Transmitting Your Voice	42	Map and vehicle settings	52
Adjusting the Radio Volume	42	Enabling maps	52
Radio Settings	42	Navigation settings	53
Garmin PowerSwitch™ App	43	Calculation Mode Settings	53
Activating a Power Switch	43	Setting a simulated location	53
Turning Off All Switches	43	Bluetooth settings	53
Customising a Button	44	Wi-Fi settings	53
Assigning a Switch to a Control Input	44	Driver Assistance Settings	54
Adding a Custom Layout	44	Display settings	54
Routines	45	Traffic Settings	54
Viewing the Owner's Manual on Your Device	46	Units and time settings	54
Media player	46	Setting the Time	54
Adding the Music Player Tool to the Map	46	Language and Keyboard Settings	55
Changing the Media Source	47	Device and privacy settings	55
BirdsEye Imagery	47	Restoring settings	55
Downloading BirdsEye Imagery	47	Device information	55
Trip planner	47	Viewing E-label Regulatory and Compliance Information	55
Planning a trip	48		
Editing and reordering locations in a trip	48		

Specifications.....	56	Mounting the Device.....	62
Charging the Device.....	56	Opening the Front Cover.....	63
Device maintenance.....	56	Connecting Accessories.....	64
Garmin Support Centre.....	56	Connecting a Control Input.....	64
Map and Software Updates.....	56	Connecting the Device to Vehicle	
Connecting to a Wi-Fi Network.....	57	Power.....	65
Updating Maps and Software Using a		Pairing with a Garmin Navigation	
Wi-Fi Network.....	57	Device.....	65
Product updates.....	57	Garmin PowerSwitch	
Device Care.....	59	Specifications.....	66
Cleaning the outer casing.....	59	My Garmin PowerSwitch will not stay	
Cleaning the Touchscreen.....	59	connected.....	66
Avoiding theft.....	59	My accessories are not receiving	
Restarting the Device.....	59	power.....	66
Removing the Device, Mount and Suction		Wireless Cameras.....	66
Cup.....	59	Pairing the Camera with a Garmin	
Removing the Device from the		Navigation Device.....	67
Mount.....	59	Viewing the Wireless Camera.....	67
Removing the Mount from the Suction		Installing a memory card for maps and	
Cup.....	59	data.....	69
Removing the Suction Cup from the		Data management.....	69
Windscreen.....	59	About memory cards.....	69
Changing the Fuse in the Vehicle Power		Connecting the Device to Your	
Cable.....	60	Computer.....	69
Troubleshooting.....	60	Transferring GPX Files From Your	
The suction cup will not stay on my		Computer.....	70
windscreen.....	60	Transferring data from your	
My device is not acquiring satellite		computer.....	70
signals.....	60	Disconnecting the USB cable.....	70
My battery does not stay charged for		Adding BaseCamp™ Data to	
very long.....	60	Garmin Explore.....	70
My device is not contacting my		Viewing GPS signal status.....	71
emergency contact.....	61	Purchasing additional maps.....	71
My device does not connect to my			
phone.....	61		
My device does not appear as a			
removable drive on my computer.....	61		
My device does not appear as a portable			
device on my computer.....	61		
My device does not appear as either a			
portable device or a removable drive or			
volume on my computer.....	61		
Appendix.....	62		
Garmin PowerSwitch.....	62		
Mounting Considerations.....	62		

Getting started

⚠ WARNING

See the *Important safety and product information* guide in the product box for product warnings and other important information.

- 1 Connect to a Wi-Fi® network (*Connecting to a Wi-Fi Network, page 57*)(optional).
- 2 Pair your Bluetooth® phone and headset (*Pairing Your Phone and Headset, page 34*) (optional).
- 3 Update the maps and software on your device (*Product updates, page 57*).
- 4 Acquire GPS signals (*Acquiring GPS signals, page 2*).
- 5 Mount the device and connect it to power.
- 6 Adjust the screen brightness (*Adjusting the screen brightness, page 3*).
- 7 Navigate to your destination (*Starting a route, page 14*).

Device Overview



①	power key
②	microSD® memory card slot
③	USB power and data port

Turning the device on or off

- To turn the device on, press the power button or connect the device to power.
- To put the device in power saving mode, press the power button while the device is on.
While in power saving mode, the screen is off and the device uses very little power, but it can wake instantly for use.
TIP: you can charge your device faster by putting it in power saving mode while charging the battery.
- To turn off the device completely, hold the power button until a prompt appears on the screen and select **Off**.
The prompt appears after five seconds. If you release the power button before the prompt appears, the device enters power saving mode.

Acquiring GPS signals











When you turn on your navigation device, the GPS receiver must collect satellite data and establish the current location. The time required to acquire satellite signals varies based on several factors, including how far you are from the location where you last used your navigation device, whether you have a clear view of the sky, and how long it has been since you last used your navigation device. The first time you turn on your navigation device, it may take several minutes to acquire satellite signals.

- 1 Turn on the device.
- 2 Wait while the device locates satellites.
- 3 If necessary, go to an open area away from tall buildings and trees.

 in the status bar indicates the satellite signal strength. When at least half of the bars are filled, the device is ready for navigation.







Status bar icons

The status bar is located at the top of the main menu. The status bar icons display information about features on the device. You can select some icons to change settings or view additional information.

	GPS signal status. Hold to view GPS accuracy and acquired satellite information (Viewing GPS signal status, page 71).
	Bluetooth technology status. Select to view the Bluetooth settings (Bluetooth settings, page 53).
	Wi-Fi signal strength. Select to change the Wi-Fi settings (Wi-Fi settings, page 53).
	Connected to hands-free calling. Select to place a phone call (Hands-free calling, page 36).
	Active usage mode. Select to change the usage mode.
	Current time. Select to set the time (Setting the Time, page 54).
	Battery charge level.
	Garmin Drive™ app connection status (Pairing Your Phone and Headset, page 34).
	Temperature. Select to view the weather forecast (Viewing the Weather Forecast, page 50).
	Fuel status. Select to view fuel tracking information (Fuel tracking, page 20).

Using the on-screen buttons

On-screen buttons allow you to navigate the pages, menus and menu options on your device.

- Select  to return to the previous menu screen.
- Hold  to quickly return to the main menu.
- Select  or  to scroll through lists or menus.
- Hold  or  to scroll faster.
- Select  to see a context-based menu of options for the current screen.

Adjusting the volume

- 1 Select **Volume**.
- 2 Select an option:
 - Use the slider bar to adjust the volume.
 - Select  to mute the device.
 - Select a tick box to enable or disable additional sound options.

Using the audio mixer

You can use the audio mixer to set the volume levels for different audio types, such as navigation prompts or phone calls. The level for each audio type is a percentage of the master volume.



- 1 Select **Volume**.
- 2 Select **Audio Mixer**.
- 3 Use the sliders to adjust the volume for each audio type.

Adjusting the screen brightness

- 1 Select **Settings > Display > Brightness**.
- 2 Use the slider bar to adjust the brightness.

Transportation modes

Routing and navigation are calculated differently based on your transportation mode. The current transportation mode is indicated by an icon in the status bar.



	Vehicle mode
	Motorcycle mode
	Off-road mode

Choosing a Transportation Mode

Select the transportation mode icon on the status bar.

Using the Large Button Keyboard

You can enable additional keyboard languages or layouts in the language and keyboard settings .

- Select  or  to view more characters.
- Select  to switch to other keyboard languages and layouts.

Installation

Mounting your device in a motorcycle

Powered Motorcycle Mount

WARNING

Garmin® strongly recommends having an experienced installer with the proper knowledge of electrical systems install the device. Incorrectly wiring the power cable can result in damage to the vehicle or the battery and can cause bodily injury.

See the *Important safety and product information* guide in the product box for product warnings and other important information.

The device must be mounted in a suitable and secure location on your motorcycle, based on available power sources and safe cable routing. No fuse is required.

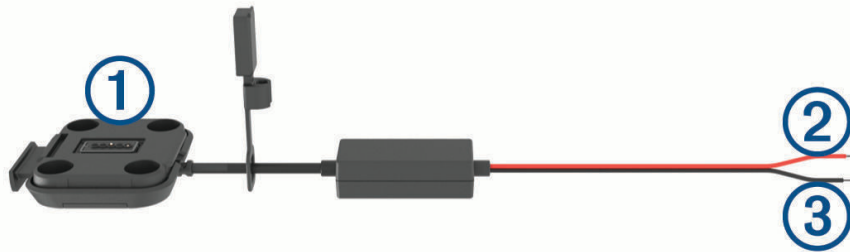

①	Motorcycle mount
②	10 to 30 Vdc system power (red)
③	System ground (black)

NOTE: additional parts are included with the device to provide more installation and wiring options. Contact an experienced installer for more information about using these parts with your motorcycle.

Crimp-Style Ring Terminal: connects the wiring harness directly to the battery terminal.

Cable Tie: secures cables to the motorcycle frame.

Installing the Handlebar Base

The device includes parts for two handlebar installation solutions. Custom mounts may require additional hardware.

Installing the U-bolt and Handlebar Base

- 1 Place the U-bolt ① around the handlebar ②, and thread the ends through the handlebar base ③.

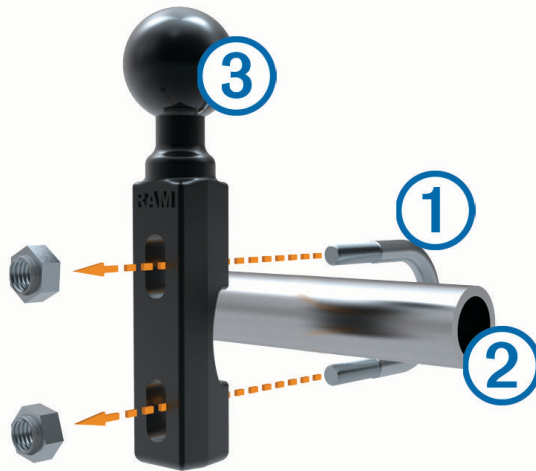

- 2 Tighten the nuts to secure the base.

NOTE: the recommended torque is 50 lbf-in (5.65 N-m). Do not exceed torque of 80 lbf-in (9.04 N-m).

Installing the Handlebar Base to the Clutch-Clamp or Brake-Clamp Brackets

- 1 Remove the two factory bolts on your clutch-clamp or brake-clamp bracket ①.

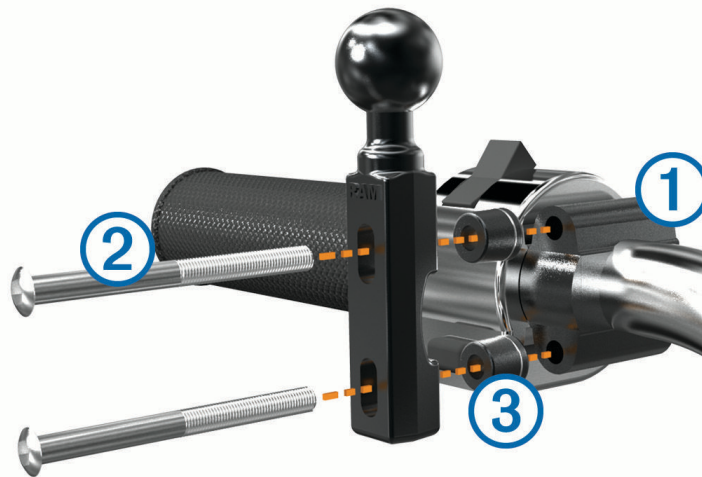

NOTE: both 1/4 in. (65 mm) standard and M6 bolts are included. Match the size of the factory bolts on your clutch-clamp or brake-clamp bracket.

- 2 Thread the new bolts ② through the handlebar base, spacers ③, and clutch-clamp or brake-clamp bracket.
- 3 Tighten the bolts to secure the base.

Attaching the Power Cables to the Motorcycle Mount

- 1 Thread the power cable connector ① through the opening ② in the motorcycle mount.

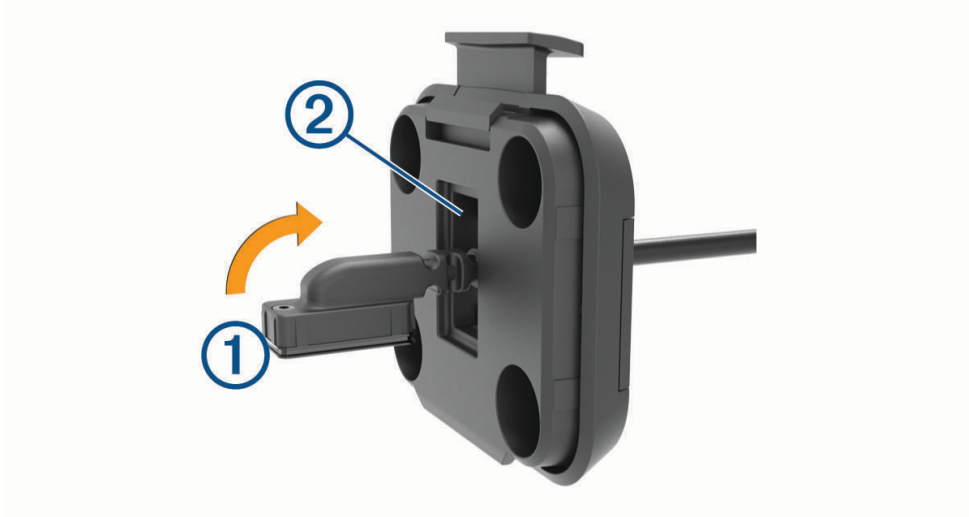

- 2 Pull the cable back until it is snug.
- 3 Screw the black screw ③ into the back of the mount ④ to hold the cable in place.



NOTE: an additional replacement screw is included in the box.

Attaching the Base Plate to the Motorcycle Mount

NOTICE

Direct, sustained contact with the base plate or any part of the motorcycle may damage the mount over time. To prevent this kind of damage, you must place the mounting spacers between the mount and base plate, and make sure that no part of the device or mount touches the motorcycle.

- 1 Thread the M4 x 20 mm panhead screws ① through the washers ②, cradle, spacers ③ and base plate ④.

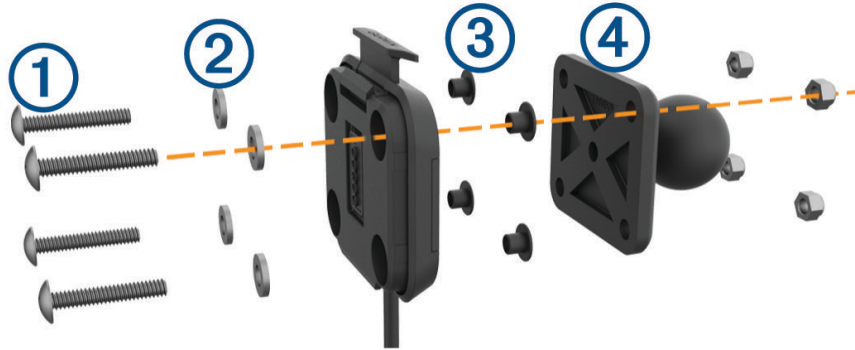

- 2 Tighten the nuts to secure the base plate.

Attaching the Base Plate to the Handlebar Base

- 1 Align the ball of the handlebar base ① and the ball of the base plate ② with each end of the double-socket arm ③.

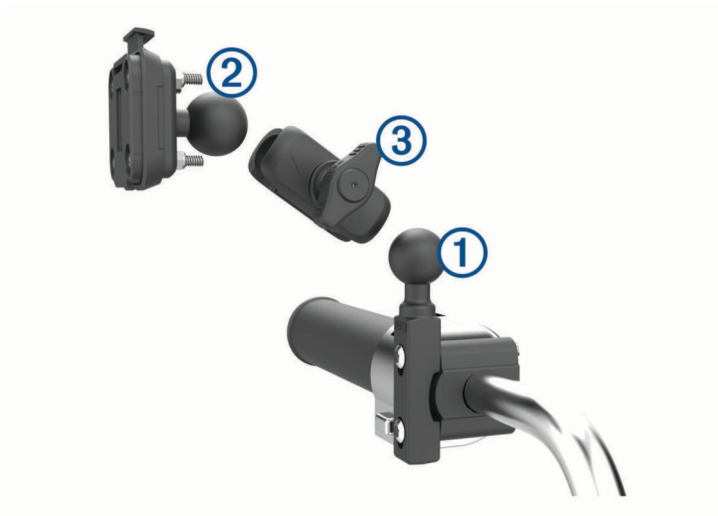

- 2 Insert each ball into the double-socket arm.
- 3 Tighten the knob slightly.
- 4 Adjust for optimal viewing and operation.
- 5 Tighten the knob to secure the mount.

Installing your device in the motorcycle mount

- 1 Fit the bottom of your device into the cradle.



- 2 Push the top of the device forward until it snaps into place.
The latch ① on the mount stays up after you have inserted the device.

Removing Your Device from the Motorcycle Mount

- 1 Press the release button on the top of the mount.
- 2 Lift out the device.

Mounting Your Device in an Automobile

NOTICE

Before mounting the device, check the local laws pertaining to windscreen mounting.

⚠ WARNING

This product contains a lithium-ion battery. To prevent the possibility of personal injury or product damage caused by battery exposure to extreme heat, store the device out of direct sunlight.

Do not use the suction cup mount on a motorcycle.

See the *Important safety and product information* guide in the product box for product warnings and other important information.

NOTE: the automobile mount is not included with all device models. Go to garmin.com to purchase optional accessories.

1 Plug the automotive power cable ① into the port ② on the device.

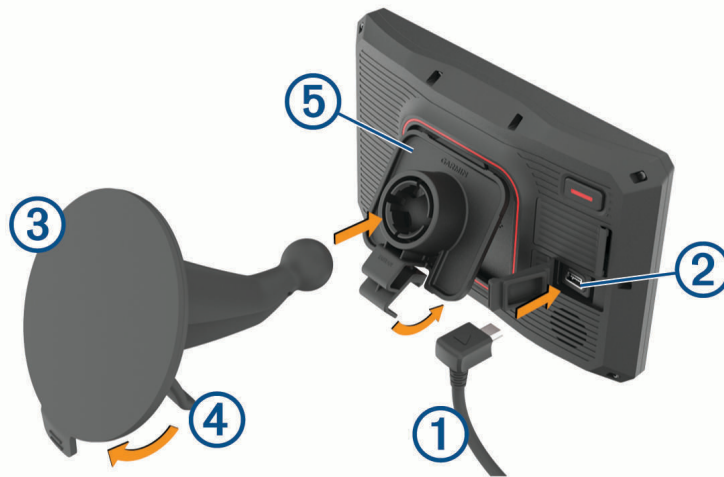

2 Remove the clear plastic from the suction cup ③.

3 Clean and dry your windscreen and the suction cup with a lint-free cloth.

4 Press the suction cup to the windscreen, and flip the lever ④ back toward the windscreen.

5 Snap the cradle ⑤ onto the suction-cup arm.

6 Fit the bottom of your device into the cradle.

7 Press the device into the cradle until it snaps into place.

8 Plug the other end of the automotive power cable into a power outlet.

Rider Awareness Features and Alerts

⚠ CAUTION

The rider alerts and speed limit features are for information only and do not replace your responsibility to abide by all posted speed limit signs and to use safe driving judgement at all times. Garmin is not responsible for any traffic fines or citations that you receive for failing to follow all applicable traffic laws and signs.

Your device provides features that can help encourage safer riding, even when you are riding in a familiar area. The device plays an audible tone or message and displays information for each alert. You can enable or disable the audible tone or message for each type of alert. Not all alerts are available in all areas.

School zone or nearby school: the device plays a tone and displays the distance to and speed limit (if available) for an upcoming school or school zone.

Speed limit reduction: the device plays a tone and displays the upcoming reduced speed limit so you can be prepared to reduce your speed.

Speeding alert: the device plays a tone and displays a red border on the speed limit icon when you exceed the posted speed limit for the current road.

Level crossing: the device plays a tone and displays the distance to an upcoming level crossing.

Animal crossing: the device plays a tone and displays the distance to an upcoming animal crossing area.

Curve: the device plays a tone and displays the distance to a curve in the road.

Slower traffic: the device plays a tone and displays the distance to slower traffic when you approach slower traffic at a higher speed. Your device must be receiving traffic information to use this feature.

Break planning: the device plays a tone and suggests upcoming rest stops after you have been driving for more than two hours without stopping.

Enabling or Disabling Rider Alerts

You can turn off individual audible rider alerts. Visual alerts appear even when the audible alert is disabled.

- 1 Select **Settings > Driver Assistance > Rider Alerts**.
- 2 Select or clear the tick box next to each alert.

Red light and speed cameras

NOTICE

Garmin is not responsible for the accuracy of or the consequences of using a red light or speed camera database.

NOTE: this feature is not available for all regions or product models.

Information about red light and speed camera locations is available in some areas for some product models. The device alerts you when you approach a reported speed or red light camera.

- In some areas, your device can receive live red light and speed camera data while connected to a smartphone running the Garmin Drive app.
- You can use the Garmin Express™ software (garmin.com/express) to update the camera database stored on your device. You should update your device frequently to receive the most up-to-date camera information.

Incident Detection and Notifications

WARNING

The device allows you to send your location to an emergency contact. This is a supplementary feature and should not be relied upon as a primary method to obtain emergency assistance. The Garmin Drive app does not contact emergency services on your behalf.

NOTICE

To use this feature, your device must be connected to the Garmin Drive app using Bluetooth technology. You can set emergency contacts using the Garmin Drive app.

To use this feature, your device must be connected to a compatible external power source using the included mount or a USB cable.

Your zūmo device uses built-in sensors to detect a possible vehicle incident.

- If you set up an emergency contact, the device can send an automated text message to that contact when it detects an incident and your vehicle stops moving. This can help alert the contact to your situation if you are not able to call or send a message. This feature requires your device to be connected to the Garmin Drive app using Bluetooth technology and your phone to have an active mobile data connection to send a message.
- If you have not set up an emergency contact, the device automatically displays the nearest address or geographic coordinates, if available, when it detects an incident. This feature is helpful if you need to tell emergency personnel your location.
- If you have an inReach[®] satellite communicator connected to your zūmo device, you can manually send an SOS when your zūmo device detects an incident.

Setting Up an Incident Contact

Before you can set up an incident detection contact, you must complete these tasks:

- Connect your device to Garmin Drive ([Pairing Your Phone and Headset, page 34](#)).
- Select **Settings** > **Wireless Networks** and verify that the Phone calls option is enabled for your phone.

The device must have access to the Garmin Drive app and to your smartphone phone book during the incident contact setup. If you do not want to use your device for hands-free calling, you can disable the Phone calls option after the incident contact setup is complete.

- 1 Select **Settings** > **Driver Assistance** > **Incident Notification** > **Continue**.

A list of your smartphone contacts appears.

- 2 Select a contact, and select **Next**.

- 3 Verify the contact's phone number, and select **Next**.

- 4 Enter your name or nickname, and select **Done**.

- 5 Review the sample incident message, and select **Next**.

- 6 Follow the on-screen instructions to inform your contact that you have added them as an incident contact.

NOTE: the incident notification message includes the name or nickname you entered, but it is not sent from your phone number. The message is sent using a third-party service, and you should inform your incident contact that the incident message will come from an unknown number.

- 7 Select **OK**.

- 8 Review the information, and select **Save**.

Cancelling an Incident Notification

When the device detects an incident, a message and a voice prompt inform you that a notification will be sent to your incident contact. A 60-second countdown timer starts when the incident is detected, and the device sends the notification automatically when the timer expires. If you do not want to send the notification, you can cancel it.

Before the timer expires, select **Cancel**.

Disabling Incident Notifications

While incident notifications are disabled, the device does not send an SMS notification when it detects an incident.

- 1 Select **Settings** > **Driver Assistance** > **Incident Notification**.
- 2 Clear the **Incident Detection SMS** tick box.

inReach Remote

The inReach remote function allows you to control your inReach satellite communication device (sold separately) using your zūmo device. You can send messages, view weather reports, trigger an SOS alert and more. Go to buy.garmin.com to purchase an inReach device.

Connecting an inReach Device

- 1 Bring the inReach device within 3 m (10 ft.) of your zūmo device.
- 2 On your zūmo device, select **Apps** > **inReach**.
- 3 Follow the on-screen instructions on your zūmo device to complete the pairing process.

After the pairing process is complete, the inReach and zūmo devices connect automatically when they are within range.

Sending an inReach Message

Before you can send an inReach message using your zūmo device, you must pair it with a compatible inReach device (*Connecting an inReach Device*, page 12).

You can use your device to send inReach messages to your contacts.

- 1 Select **Apps** > **inReach** > .
- 2 Select **New Message**.
- 3 Select **Select Contacts** to add one or more contacts.
- 4 Enter a message.
- 5 Select **Send**.

SOS

During an emergency, you can use your inReach device to contact the Garmin International Emergency Response Coordination Center (IERCC) to request help. Pressing the SOS button sends a message to the Garmin IERCC, and they notify the appropriate emergency responders of your situation. You can communicate with the Garmin IERCC during your emergency while you wait for help to arrive. You should only use the SOS function in a real emergency situation.

Initiating an SOS Rescue

Before you can initiate an SOS rescue using your zūmo device, you must pair it with a compatible inReach device ([Connecting an inReach Device](#), page 12).

NOTICE

While the device is in SOS mode, do not turn off or attempt to turn off the inReach device. Doing so could prevent this feature from operating properly and could delay receipt of assistance in the event of an emergency.

1 Select **Apps > inReach**.

2 Select .

3 Wait for the SOS countdown.

The device sends a default message to the emergency response service with details about your location.

4 Reply to the confirmation message from the emergency response service.

Your reply lets the emergency response service know that you are capable of interacting with them during the rescue.

For the first 10 minutes of your rescue, an updated location is sent to the emergency response service every minute. To conserve battery power after the first 10 minutes, an updated location is sent every 10 minutes when moving and every 30 minutes when stationary.

Cancelling an SOS Rescue

If you no longer need assistance, you can cancel an SOS rescue after it is sent to the emergency response service.

Select **Cancel SOS > Cancel SOS**.

Your device transmits the cancellation request. When you receive a confirmation message from the emergency response service, the device returns to normal operation.

Viewing Helmet Law Notifications

Helmet law and eye protection notifications may appear on your zūmo device the first time your device acquires satellites and when your device approaches a location with motorcycle safety rules.

NOTICE

Garmin recommends that all riders wear helmets for safety. Helmet law notifications are for reference only, are subject to change and are not intended to be considered legal advice. Helmet law notifications are available in the U.S. and Canada only.

Select the notification to view more details.

Searching for Helmet Laws

You can search for helmet laws by state or province.

1 Select **Apps > Helmet Guide**.

2 Select a county or province.



Navigating to your destination

Routes

A route is a path from your current location to one or more destinations.

- The device calculates a recommended route to your destination based on the preferences you set, including the route calculation mode ([Changing the route calculation mode, page 14](#)) and avoidances ([Avoiding Delays, Tolls and Areas, page 19](#)).
- The device can automatically avoid roads that are not appropriate for the active vehicle profile.
- You can start navigating to your destination quickly using the recommended route, or you can select an alternative route ([Starting a route, page 14](#)).
- If there are specific roads you need to use or avoid, you can customise the route ([Shaping Your Route, page 18](#)).
- You can add multiple destinations to a route ([Adding a location to your route, page 18](#)).

Starting a route

- 1 Select **Where To?**, and search for a location.
- 2 Select a location.
- 3 Select an option:
 - To start navigating using the recommended route, select **Go!**.
 - To choose an alternative route, select  and select a route. Alternative routes appear to the right of the map.
 - To edit the course of the route, select  > **Edit Route** and add shaping points to the route ([Shaping Your Route, page 18](#)).

The device calculates a route to the location and guides you using voice prompts and information on the map ([Your route on the map, page 15](#)). A preview of the major roads in your route appears at the edge of the map for several seconds.

If you need to stop at additional destinations, you can add the locations to your route ([Adding a location to your route, page 18](#)).

Taking a Route Using Garmin Adventurous Routing™

Your device can calculate adventurous routes that prefer curvy roads, hills and fewer motorways. This feature can provide a more enjoyable ride, but it may increase the time or distance to your destination.

NOTE: this feature is not available on all device models or for all map regions.

- 1 Select **Where To? > Categories**.
- 2 If necessary, select a subcategory.
- 3 Select a location.
- 4 Select .
- 5 Use the slider to increase or decrease the level of adventure of your route.
- 6 Select **Go!**

Changing the route calculation mode

- 1 Select **Settings > Navigation > Calculation Mode**.
- 2 Select an option:
 - Select **Faster Time** to calculate routes that are faster to drive, but can be longer in distance.
 - Select **Straight Line** to calculate point-to-point routes (without roads).
 - Select **Shorter Distance** to calculate routes that are shorter in distance, but can take more time to drive.

Starting a route by using the map

You can start a route by selecting a location from the map.

- 1 Select **View Map**.
- 2 Drag and zoom the map to display the area to search.
- 3 If necessary, select **Q** to filter the displayed points of interest by category. Location markers (coloured dots) appear on the map.
- 4 Select an option:
 - Select a location marker.
 - Select a point, such as a street, junction or address location.
- 5 Select **Go!**.

Going home

The first time you start a route home, the device prompts you to enter your home location.

- 1 Select **Where To? > Go Home**.
- 2 If necessary, enter your home location.

Editing your home location

- 1 Select **Where To? > ≡ > Set Home Location**.
- 2 Enter your home location.

Your route on the map

As you travel, the device guides you to your destination using voice prompts and information on the map. Instructions for your next turn or exit, or other actions appear across the top of the map.

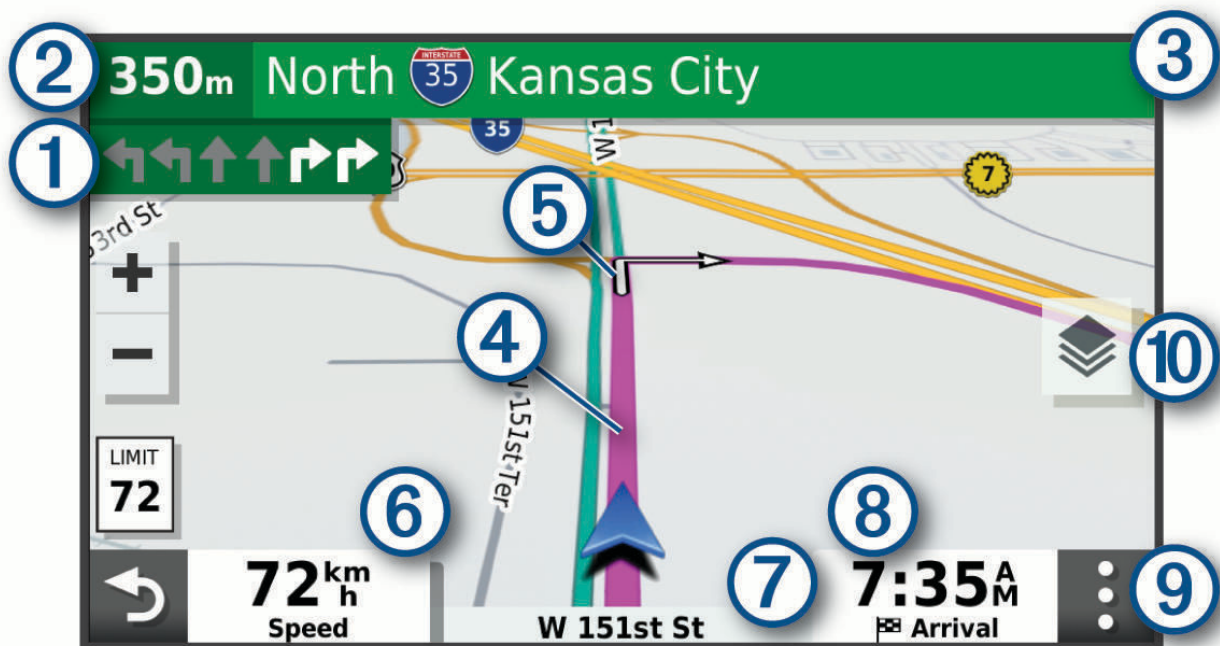

①	Next action in the route. Indicates the next turn, exit, or other action and the lane in which you should travel, if available.
②	Distance to the next action.
③	Name of the street or exit associated with the next action.
④	Route highlighted on the map.
⑤	Next action in the route. Arrows on the map indicate the location of upcoming actions.
⑥	Vehicle speed.
⑦	Name of the road on which you are travelling.
⑧	Estimated arrival time. TIP: you can touch this field to change the information it shows.
⑨	Map tools. Provides tools to show you more information about your route and surroundings.
⑩	Map layers. Allows you to change the map orientation and add topographic and BirdsEye imagery to your map view.

Active lane guidance

As you approach some turns, exits, or interchanges in your route, a detailed simulation of the road appears beside the map, if available. A coloured line ① indicates the proper lane for the turn.

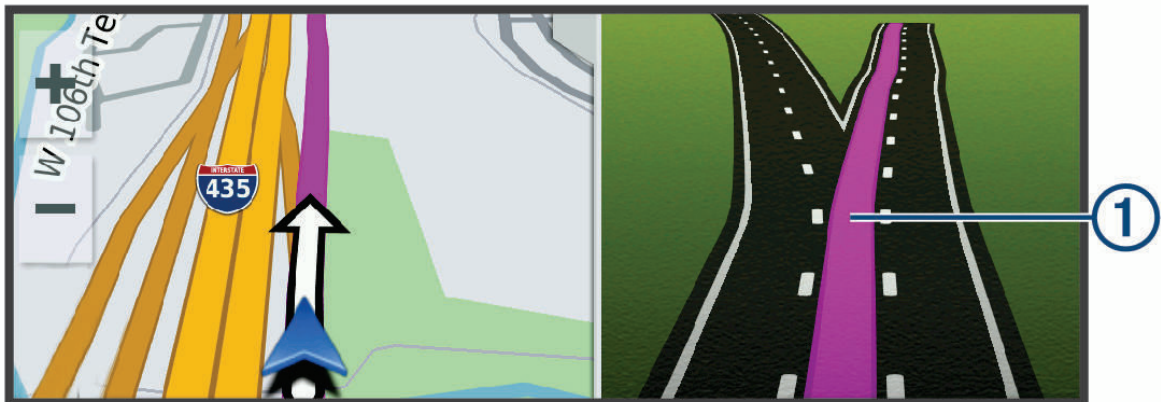

Viewing turns and directions

While navigating a route, you can view next turns, lane changes, or other directions for your route.

1 From the map, select an option:

- To view next turns and directions as you navigate, select  > **Turns**.

The map tool displays the next several turns or directions beside the map. The list updates automatically as you navigate the route.

- To view the complete list of turns and directions for the entire route, select the text bar at the top of the map.

2 Select a turn or direction (optional).

Detailed information appears. An image of the junction may appear for junctions on major roads, if available.

Viewing the Entire Route on the Map

1 While navigating a route, select anywhere on the map.

2 Select .

Arriving at your destination

When you approach your destination, the device provides information to help you complete your route.

-  indicates the location of your destination on the map, and a voice prompt announces you are approaching your destination.
- When you approach some destinations, the device automatically prompts you to search for parking. You can select **Yes** to find nearby parking areas ([Parking Near Your Destination, page 17](#)).
- When you stop at your destination, the device automatically ends the route. If the device does not detect your arrival automatically, you can select **Stop** to end your route.

Parking Near Your Destination

Your device can help you find a parking spot near your destination. When you approach some destinations, the device automatically prompts you to search for parking.

1 Select an option:

- When the device prompts you, select **Yes** to search for nearby parking.
- If the device does not prompt you, select **Where To? > Categories > Parking**, and select  > **My Destination**.

2 Select **Filter Parking**, and select one or more categories to filter parking by availability, type, price, or payment methods (optional).

NOTE: detailed parking data is not available in all areas or for all parking locations.

3 Select a parking location, and select **Go! > Add as Next Stop**.

The device guides you to the parking area.

Changing Your Active Route

Adding a location to your route

Before you can add a location to your route, you must be navigating a route ([Starting a route, page 14](#)).

You can add locations to the middle or end of your route. For example, you can add a petrol station as the next destination in your route.

TIP: to create complex routes with multiple destinations or scheduled stops, you can use the trip planner to plan, schedule, and save a trip ([Planning a trip, page 48](#)).

- 1 From the map, select  > **Where To?**.
- 2 Search for a location.
- 3 Select a location.
- 4 Select **Go!**.
- 5 Select an option:
 - To add the location as the next destination in your route, select **Add as Next Stop**.
 - To add the location to the end of your route, select **Add as Last Stop**.
 - To add the location and edit the order of destinations in your route, select **Add to Active Route**.

The device re-calculates the route to include the added location and guides you to the destinations in order.

Shaping Your Route

Before you can shape your route, you must start a route ([Starting a route, page 14](#)).

You can manually shape your route to change its course. This allows you to direct the route to use a certain road or go through a certain area without adding a destination to the route.

- 1 Select anywhere on the map.
- 2 Select **Shape Route**.

TIP: you can select  to zoom in on the map and select a more precise location.

The device enters route-shaping mode and recalculates the route to travel through the selected location.
- 3 Select **Go!**.
- 4 If necessary, select an option:
 - To add more shaping points to the route, select additional locations on the map.
 - To remove a shaping point, select the shaping point and select **Remove**.

Taking a detour

You can take a detour for a specified distance along your route or detour around specific roads. This is useful if you encounter construction zones, closed roads or poor road conditions.

- 1 From the map, select  > **Edit Route**.
- 2 Select an option:
 - To re-route for a specific distance, select **Detour by Distance**.
 - To detour around a specific road on the route, select **Detour by Road**.

Stopping the route

From the map, select  > **Stop**.

Avoiding Delays, Tolls and Areas

Avoiding traffic delays on your route

Before you can avoid traffic delays, you must be receiving traffic information.

By default, the device optimises your route to avoid traffic delays automatically. If you have disabled this option in the traffic settings ([Traffic Settings, page 54](#)), you can view and avoid traffic delays manually.

- 1 While navigating a route, select  > **Traffic**.
- 2 Select **Alternative Route**, if available.
- 3 Select **Go!**.

Avoiding toll roads

Your device can avoid routing you through areas that require tolls, such as toll roads, toll bridges, or congestion areas. The device may still include a toll area in your route if no other reasonable routes are available.

- 1 Select **Settings > Navigation**.
- 2 Select an option:
NOTE: the menu changes based on your area and the map data on your device.
 - Select **Toll Roads**.
 - Select **Tolls and Fees > Toll Roads**.
- 3 Select an option:
 - To be asked each time before routing through a toll area, select **Always Ask**.
 - To always avoid tolls, select **Avoid**.
 - To always allow tolls, select **Allow**.
- 4 Select **Save**.

Avoiding toll stickers

If the map data on your device contains detailed toll sticker information, you can avoid or allow roads that require toll stickers for each country.

NOTE: this feature is not available in all areas.

- 1 Select **Settings > Navigation > Tolls and Fees > Toll Stickers**.
- 2 Select a country.
- 3 Select an option:
 - To be asked each time before routing through an area that requires toll stickers, select **Always Ask**.
 - To always avoid roads that require toll stickers, select **Avoid**.
 - To always allow roads that require toll stickers, select **Allow**.
- 4 Select **Save**.

Avoiding road features

- 1 Select **Settings > Navigation > Avoidances**.
- 2 Select the road features to avoid on your routes and select **Save**.
NOTE: when motorway avoidances are enabled, long-distance routes may still include motorways.

Custom Avoidances

Custom avoidances allow you to select specific areas or sections of road to avoid. When the device calculates a route, it avoids these areas and roads unless no other reasonable route is available.

Avoiding a road

- 1 Select **Settings** > **Navigation** > **Custom Avoidances**.
- 2 Select **Add Avoid Road**.
- 3 Select the starting point of the section of road to avoid and select **Next**.
- 4 Select the ending point of the road section and select **Next**.
- 5 Select **Done**.

Avoiding an area

- 1 Select **Settings** > **Navigation** > **Custom Avoidances**.
- 2 If necessary, select **Add Avoidance**.
- 3 Select **Add Avoid Area**.
- 4 Select the upper left corner of the area to avoid and select **Next**.
- 5 Select the lower right corner of the area to avoid and select **Next**.
The selected area is shaded on the map.
- 6 Select **Done**.

Disabling a custom avoidance

You can disable a custom avoidance without deleting it.

- 1 Select **Settings** > **Navigation** > **Custom Avoidances**.
- 2 Select a created avoidance.
- 3 Select  > **Disable**.

Deleting custom avoidances

- 1 Select **Settings** > **Navigation** > **Custom Avoidances** > .
- 2 Select an option:
 - To delete all custom avoidances, select **Select All** > **Delete**.
 - To delete one custom avoidance, select the avoidance and select **Delete**.

Navigating off road

If you are not following roadways as you navigate, you can use Straight Line mode.

Select **Settings** > **Navigation** > **Calculation Mode** > **Straight Line** > **Save**.

The device ignores roads and calculates routes using straight lines between destinations.

Fuel tracking

You can set your device to estimate your fuel usage, warn you when you approach the maximum estimated fuel distance, and suggest fuel stops based on your estimated fuel range. When fuel tracking is enabled,  indicates the current fuel status.

White: fuel tracking is disabled, or the device is not connected to the motorcycle mount.

Green: the estimated fuel range is above the fuel tank warning level.

Yellow: the estimated fuel range is below the fuel tank warning level.

Red: the estimated distance remaining on the tank is 0.

Enabling fuel tracking

Before you can enable fuel tracking, the device must be in motorcycle mode or off road mode and placed in the motorcycle mount.

When you enable fuel tracking, a fuel gauge appears on the trip computer ([Viewing the trip information page, page 32](#)).

- 1 Fill your fuel tank.
- 2 Select **Apps > Fuel Settings > Fuel Tracking**.
- 3 Select **Distance Per Tank**.
- 4 Enter the distance the vehicle travels on a tank of fuel and select **Done**.

Setting a low-fuel warning

You can set the device to warn you when the tank is low on fuel.

NOTE: the device must be connected to the motorcycle mount to give low-fuel warnings.

- 1 Enable fuel tracking ([Enabling fuel tracking, page 21](#)).
- 2 Select **Remaining Fuel Warning**.
- 3 Enter a distance and select **Done**.

When you have only enough fuel left to travel the distance you entered, a low-fuel warning appears on the map page.

Resetting the Fuel Tank Mileage

When you refill your fuel tank, you should reset the fuel tank mileage on your device to more accurately track your remaining fuel.

Select **Apps > Fuel Settings > Reset Fuel Tank**.

Enabling dynamic fuel stops

Before you can enable dynamic fuel stops, the device must be in motorcycle mode, placed in the motorcycle mount and fuel tracking must be enabled.

You can set the device to suggest fuel stops based on your estimated fuel range.

Select **Apps > Fuel Settings > Dynamic Fuel Stops**.

Finding and saving locations

The maps loaded in your device contain locations, such as restaurants, hotels, vehicle services, and detailed street information. The Where To? menu helps you find your destination by providing several methods to browse, search, and save this information.

- Enter search terms to quickly search all location information ([Finding a location using the search bar, page 22](#)).
- Browse or search pre-loaded points of interest by category ([Points of Interest, page 22](#)).
- Search and check into Foursquare® points of interest ([Searching Foursquare points of interest, page 27](#)).
- Use search tools to find specific locations, such as addresses, junctions, or geographic coordinates ([Search tools, page 26](#)).
- Search near a different town or area ([Changing the search area, page 25](#)).
- Save your favourite locations to find them quickly in the future ([Saving Locations, page 28](#)).
- Return to recently found locations ([Viewing history, page 27](#)).

Finding a location using the search bar

You can use the search bar to search for locations by entering a category, brand name, address or town name.

- 1 Select **Where To?**.
- 2 Select **Search** in the search bar.
- 3 Enter all or part of the search term.
Suggested search terms appear below the search bar.
- 4 Select an option:
 - To search for a type of business, enter a category name (for example, "cinemas").
 - To search for a business name, enter all or part of the name.
 - To search for an address near you, enter the house number and street name.
 - To search for an address in another town, enter the house number, street name, town and county.
 - To search for a town, enter the town and county.
 - To search for coordinates, enter latitude and longitude coordinates.
- 5 Select an option:
 - To search using a suggested search term, select the term.
 - To search using the text you entered, select **Q**.
- 6 If necessary, select a location.

Points of Interest

NOTICE

You are responsible for understanding and complying with any applicable rules, laws or regulations associated with points of interest.

A point of interest is a place that you may find useful or interesting. Points of interest are organised by category and can include popular travel destinations such as petrol stations, restaurants, hotels, and entertainment venues.

Finding a location by category

- 1 Select **Where To?**.
- 2 Select a category or select **Categories**.
- 3 If necessary, select a subcategory.
- 4 Select a location.

Navigating to points of interest within a venue

NOTE: this feature may not be available in all areas or for all product models.

You can create a route to a point of interest (POI) within a larger venue, such as a store in a shopping centre or a specific terminal in an airport.

- 1 Select **Where To? > Search**.
- 2 Select an option:
 - To search for the venue, enter the name or address of the venue, select **Q**, and go to step 3.
 - To search for the POI, enter the name of the POI, select **Q**, and go to step 5.
- 3 Select the venue.
A list of categories appears below the venue, such as restaurants, car hire, or terminals.
- 4 Select a category.
- 5 Select the POI, and select **Go!**.

The device creates a route to the parking area or venue entrance closest to the POI. When you arrive at the destination, a chequered flag indicates the recommended parking area. A labelled point indicates the location of the POI within the venue.

Exploring a venue

NOTE: this feature may not be available in all areas or for all product models.

You can view a list of all points of interest located within each venue.

- 1 Select a venue.
- 2 Select **i** > **Explore this Venue**.

Viewing Your Garmin Explore™ Points of Interest

- 1 Select **Where To? > Explore**.
- 2 Select a data type.
- 3 Select an item to view the details.

Synchronising Garmin Explore Account Data

Before you can synchronise account data, you must connect to the Garmin Drive app and enable Garmin Explore.

You can synchronise data, such as tracks and saved locations, with your Garmin Explore account. This can be helpful to keep your data available on each of your compatible devices. Your device periodically synchronises data with your account automatically. You can also synchronise data manually at any time.

- 1 Select **Where To? > Explore**.
- 2 Select **🔑 > Sync Explore Data**.

Location Search Results

By default, the location search results appear in a list, with the nearest location at the top. You can scroll down to view more results.

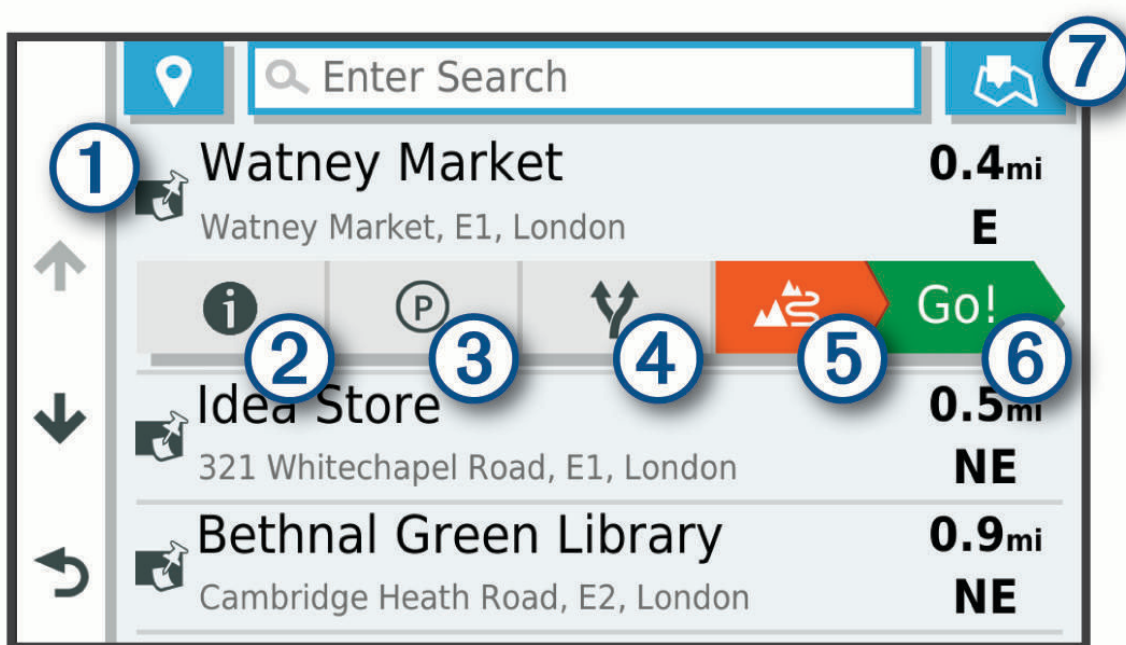



①	Select a location to view the option menu.
② i	Select to view detailed information about the selected location.
③ P	Select to find parking areas near the location.
④ Y	Select to view alternate routes to the locations.
⑤ AS	Select to start navigating to the location using Garmin Adventurous Routing.
⑥ Go!	Select to start navigating to the location using the recommended route.
⑦ Map	Select to view the search results on the map.

Location Search Results on the Map

You can view the results of a location search on the map instead of in a list.

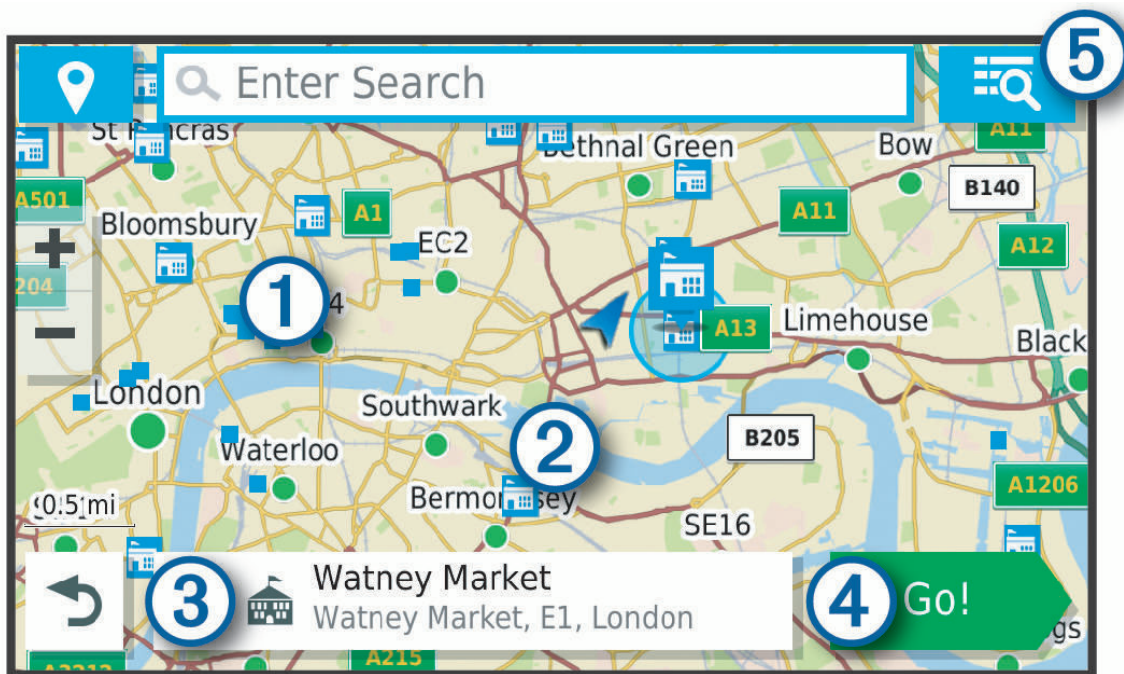
From the location search results, select **Map**. The nearest location appears at the centre of the map, and basic information about the selected location appears at the bottom of the map.



①	Drag the map to view additional search results.
②	Additional search results. Select to view another location.
③	Selected location summary. Select to view detailed information about the selected location.
④ Go!	Select to start navigating to the location using the recommended route.
⑤ 	Select to view the search results in a list.

Changing the search area

By default, the device searches near your current location. You can also search other areas, such as near your destination, near another city, or along your active route.

- 1 Select **Where To?**.
- 2 Select .
- 3 Select an option.

Parking

Your zūmo device includes detailed parking data, which can help you find nearby parking based on the likelihood of available parking spots, type of parking area, price, or accepted payment methods.

NOTE: detailed parking data is not available in all areas or for all parking locations.

Finding Parking Near Your Current Location

- 1 Select **Where To? > Categories > Parking**.
- 2 Select **Filter Parking**, and select one or more categories to filter parking by availability, type, price, or payment methods (optional).
NOTE: detailed parking data is not available in all areas or for all parking locations.
- 3 Select a parking location.
- 4 Select **Go!**.

Finding Parking Near a Specified Location

- 1 Search for a location.
- 2 From the location search results, select a location.
- 3 Select **P**.
A list of parking areas near the selected location appears.
- 4 Select **Filter Parking**, and select one or more categories to filter parking by availability, type, price, or payment methods (optional).
NOTE: detailed parking data is not available in all areas or for all parking locations.
- 5 Select a parking location.
- 6 Select **Go!**.

Understanding Parking Colours and Symbols

Parking locations that include detailed parking data are colour-coded to show the likelihood of finding parking. Symbols indicate the type of parking available (street or car park), relative pricing information and payment type. You can view the legend for these colours and symbols on the device.

From the parking search results, select .

Search tools

Search tools allow you to search for specific types of locations by responding to on-screen prompts.

Finding an address

NOTE: the order of the steps may change depending on the map data loaded on your device.

- 1 Select **Where To?**.
- 2 If necessary, select  to search near a different town or area.
- 3 Select **Address**.
- 4 Follow the on-screen instructions to enter address information.
- 5 Select the address.

Finding a junction

You can search for a junction between two streets, motorways, or other roads.

- 1 Select **Where To? > Junctions**.
- 2 Follow the on-screen instructions to enter street information.
- 3 Select the junction.

Finding a location using coordinates

You can find a location using latitude and longitude coordinates.

- 1 Select **Where To? > Coordinates**.
- 2 If necessary, select  and change the coordinate format or datum.
- 3 Enter the latitude and longitude coordinates.
- 4 Select **View on Map**.

Finding HISTORY® points of interest

NOTE: this feature is not available on all product models or for all map regions.

NOTICE

You are responsible for understanding and complying with any applicable rules, laws or regulations associated with campsites and points of interest.

Your device includes HISTORY points of interest, which allow you to find and learn about historically significant locations and attractions, such as historic buildings, monuments, museums and notable locations of historic events.

- 1 Select **Where To? > HISTORY®**.
- 2 Select a category.
- 3 Select a location.
- 4 Select  to view a photo and a short summary of the location's history.

Foursquare

Foursquare is a location-based social network. Your device includes millions of pre-loaded Foursquare points of interest, which are indicated by the Foursquare logo in your location search results.

You can connect to your Foursquare account using the Garmin Drive app on your compatible smartphone. This allows you to view Foursquare location details, check in to a location and search for points of interest in the online Foursquare database.

Connecting to your Foursquare account

Before you can use this feature, your device must be connected to a supported phone running the Garmin Drive app ([Pairing Your Phone and Headset, page 34](#)).

- 1 On your smartphone, open the Garmin Drive app.
- 2 Select  > **Foursquare®** > **Login**.
- 3 Enter your Foursquare login information.

Searching Foursquare points of interest

You can search for Foursquare points of interest loaded on your device. While your device is connected to your Foursquare account using the Garmin Drive app, the search provides the most up-to-date results from the online Foursquare database and customised results from your Foursquare user account ([Connecting to your Foursquare account, page 27](#)).

Select **Where To?** > **Foursquare®**.

Viewing Foursquare location details

Before you can use this feature, your device must be connected to your Foursquare account using the Garmin Drive app ([Connecting to your Foursquare account, page 27](#)).

You can view detailed Foursquare location information, such as user ratings, restaurant pricing information, and hours of operation.

- 1 From the location search results, select a Foursquare point of interest.
- 2 Select .

Checking in with Foursquare

Before you can use this feature, your device must be connected to your Foursquare account using the Garmin Drive app ([Connecting to your Foursquare account, page 27](#)).

- 1 Select **Where To?** > **Foursquare®** > **Check In**.
- 2 Select a point of interest.
- 3 Select  > **Check In**.

Tripadvisor®

NOTICE

Garmin is not responsible for the accuracy or timeliness of the Tripadvisor information.

You are responsible for understanding and complying with any applicable rules, laws or regulations associated with points of interest.

Your device includes Tripadvisor traveller ratings. Tripadvisor ratings appear automatically in the search results list for restaurants, hotels and attractions. You can also search for nearby Tripadvisor points of interest and sort by distance or popularity.

Finding Tripadvisor points of interest

- 1 Select **Where To?** > **Tripadvisor**.
- 2 Select a category.
A list of nearby Tripadvisor points of interest for the category appears.
- 3 Select **Sort Results** to sort the search results by distance or popularity (optional).

Viewing history

Your device stores a history of the last 50 locations you have found.

Select **Where To?** > **History**.

Clearing the list of recently found places

Select **Where To?** > **History** >  > **Clear** > **Yes**.

Viewing current location information

You can use the Where Am I? page to view information about your current location. This feature is helpful if you need to tell emergency personnel your location.

From the map, select the vehicle.

Finding emergency services and fuel

You can use the Where Am I? page to find the nearest hospitals, police stations, and fuel stations.

- 1 From the map, select the vehicle.
- 2 Select **Hospitals**, **Police Station**, **Petrol Stations** or **Roadside Assist..**

NOTE: some service categories are not available in all areas.

A list of locations for the selected service appears, with the nearest locations at the top.

- 3 Select a location.
- 4 Select an option:
 - To navigate to the location, select **Go!**.
 - To view the phone number and other location details, select .

Getting directions to your current location

If you need to tell another person how to get to your current location, your device can give you a list of directions.

- 1 From the map, select the vehicle.
- 2 Select  > **Directions to Me**.
- 3 Select a starting location.
- 4 Select **Select**.

Adding a shortcut

You can add shortcuts to the Where To? menu. A shortcut can point to a location, a category, or a search tool. The Where To? menu can contain up to 36 shortcut icons.

- 1 Select **Where To?** > **Personalise**.
- 2 Select an item.

Removing a shortcut

- 1 Select **Where To?** >  > **Remove Shortcut(s)**.
- 2 Select a shortcut to remove.
- 3 Select the shortcut again to confirm.
- 4 Select **Done**.

Saving Locations

Saving a location

- 1 Search for a location (*Finding a location by category, page 22*).
- 2 From the search results, select a location.
- 3 Select  > **Save**.
- 4 Enter a name and select **Done**.

Saving a Location by Using the Map



You can save a location by selecting a location from the map.

- 1 Select **View Map**.
- 2 Drag and zoom the map to display the area to search.
- 3 Select a point, such as a street, junction or address location.
- 4 Select **Save**.
- 5 Select one or more options:
 - To change the name of a location, select **Name**, and enter a name.
 - To change the location marker, select **Map Symbol**.
 - To assign a collection category, select **Collections**.
- 6 Select **Done**.

Saving your current location

- 1 From the map, select the vehicle icon.
- 2 Select **Save**.
- 3 Enter a name and select **Done**.
- 4 Select **OK**.

Editing a Saved Location

- 1 Select **Where To? > Favourites**.
- 2 If necessary, select a category.
- 3 Select a location.
- 4 Select .
- 5 Select  > **Edit**.
- 6 Select an option:
 - Select **Name**.
 - Select **Phone Number**.
 - Select **Categories** to assign categories to the saved location.
 - Select **Change Map Symbol** to change the symbol used to mark the saved location on a map.
- 7 Edit the information.
- 8 Select **Done**.

Deleting a favourite location

NOTE: deleted locations cannot be recovered.

- 1 Select **Where To? > Favourites**.
- 2 Select  > **Delete Favourite(s)**.
- 3 Select the box next to the saved locations to delete and select **Delete**.

Using the Map

You can use the map to navigate a route ([Your route on the map, page 15](#)) or to view a map of your surroundings when no route is active.

- 1 Select **View Map**.
- 2 Touch anywhere on the map.
- 3 Select an option:
 - Drag the map to pan left, right, up, or down.
 - To zoom in or out, select **+** or **-**.
 - To switch between North Up and 3-D views, select **▲**.
 - To filter the displayed points of interest by category, select **Q**.
 - To start a route, select a location on the map, and select **Go!** ([Starting a route by using the map, page 15](#)).

Map Tools

Map tools provide quick access to information and device functions while you view the map. When you activate a map tool, it appears in a panel at the edge of the map.

Stop: stops navigation of the active route.

Edit Route: allows you to re-route or skip locations in your route ([Changing Your Active Route, page 18](#)).

Mute: mutes the device audio.

Towns Ahead: shows upcoming towns and services along your active route or along a highway.

Up Ahead: shows upcoming locations along the route or the road on which you are travelling ([Up ahead, page 31](#)).

Elevation: displays elevation changes ahead.

Traffic: displays traffic conditions along your route or in your area ([Viewing upcoming traffic, page 32](#)). This feature is not available in all areas or for all device models.

Trip Data: displays customisable trip data, such as speed or mileage ([Viewing trip data from the map, page 31](#)).

Track Recorder: displays the track data for your active route.

Turns: displays a list of upcoming turns in your route ([Viewing turns and directions, page 17](#)).

Phone: displays a list of recent phone calls from your connected phone, and displays in-call options while a phone call is active.

Weather: displays weather conditions for your area.

Report Camera: allows you to report a speed or red light camera. This tool is available only when you have speed or red light camera data on your device and you have an active connection to the Garmin Drive app ([Pairing Your Phone and Headset, page 34](#)).

Music Player: displays media controls and media information.

Group Ride: displays the distance and direction of the members in your group ride ([Group Ride, page 39](#)).

Radio: allows you to use the push-to-talk feature with a compatible Bluetooth headset ([Enabling Push-to-Talk with a Headset, page 42](#)).

Viewing a map tool

- 1 From the map, select **⋮**.
- 2 Select a map tool.
The map tool appears in a panel at the edge of the map.
- 3 When you have finished using the map tool, select **✕**.

Up ahead

The Up Ahead tool provides information about upcoming locations along your route or the road on which you are travelling. You can view upcoming points of interest by category, such as restaurants, fuel stations or roadside services.

You can customise three categories to show in the Up Ahead tool.

Viewing upcoming locations

1 From the map, select  > **Up Ahead**.

While you are travelling, the map tool shows the next location along your road or route.

2 Select an option:

- If the map tool shows categories, select a category to view a list of nearby locations in that category.
- If the map tool shows upcoming locations, select a location to view location details or start a route to the location.

Customising the up ahead categories

You can change the location categories that appear in the Up Ahead tool.

1 From the map, select  > **Up Ahead**.

2 Select a category.

3 Select .

4 Select an option:

- To move a category up or down in the list, select and drag the arrow next to the category name.
- To change a category, select the category.
- To create a custom category, select a category, select **Custom Search** and enter the name of a business or category.

5 Select **Save**.

Towns Ahead

While you are travelling on a highway or navigating a route that includes a highway, the Towns Ahead tool provides information about upcoming towns along the highway. For each town, the map tool shows the distance to the highway exit and the services available, similar to the information on highway road signs.

Viewing Upcoming Towns and Exit Services

1 From the map, select  > **Towns Ahead**.

While you are travelling along a motorway or an active route, the map tool shows information about upcoming towns and exits.

2 Select a town.

The device shows a list of points of interest located at the selected town exit, such as fuel stations, lodging or restaurants.

3 Select a location, and select **Go!** to start navigating.

Trip information

Viewing trip data from the map

From the map, select  > **Trip Data**.

Customising the trip data fields

- 1 From the map, select  > **Trip Data**.
- 2 Select a trip data field.
- 3 Select an option.

The new trip data field appears in the trip data map tool.

Viewing the trip information page

The trip information page displays your speed and provides statistics about your trip.

From the map, select **Speed**.

Resetting trip information

- 1 From the map, select **Speed**.
- 2 Select  > **Reset Field(s)**.
- 3 Select an option:
 - When not navigating a route, select **Select All** to reset every data field on the first page except the speedometer.
 - Select **Reset Overall Data** to reset the information on the trip computer.
 - Select **Reset Max. Speed** to reset the maximum speed.
 - Select **Reset Trip B** to reset the odometer.

Viewing upcoming traffic

NOTICE

Garmin is not responsible for the accuracy or timeliness of the traffic information.

Before you can use this feature, your device must be receiving traffic data ([Traffic, page 37](#)).

You can view traffic incidents coming up along your route or along the road on which you are travelling.

- 1 While navigating a route, select  > **Traffic**.

The nearest upcoming traffic incident appears in a panel on the right side of the map.
- 2 Select the traffic incident to view additional details.

Viewing traffic on the map

The traffic map shows colour-coded traffic flow and delays on nearby roads.

- 1 From the main menu, select **Apps** > **Traffic**.
- 2 If necessary, select  > **Legend** to view the legend for the traffic map.

Searching for traffic incidents

- 1 From the main menu, select **Apps** > **Traffic**.
- 2 Select  > **Incidents**.
- 3 Select an item in the list.
- 4 If there is more than one incident, use the arrows to view additional incidents.

Customising the map

Customising the map layers

You can customise which data appears on the map, such as icons for points of interest and road conditions.

- 1 Select **Settings** > **Map & Vehicle** > **Map Layers**.
- 2 Select the layers to include on the map, and select **Save**.

Changing the map data field

- 1 From the map, select a data field.
NOTE: you cannot customise Speed.
- 2 Select a type of data to display.

Changing the Map Buttons

- 1 From the map, hold a map button.
- 2 Select an option:
 - To replace a map button, select a map button and select a map button to display.
 - To remove a map button, select .
- 3 Select **Save**.

Changing the map perspective

- 1 Select **Settings > Map & Vehicle > Driving Map View**.
- 2 Select an option:
 - Select **Track Up** to display the map in two dimensions (2-D), with your direction of travel at the top.
 - Select **North Up** to display the map in 2-D with north at the top.
 - Select **3-D** to display the map in three dimensions.
- 3 Select **Save**.

Live services, traffic and smartphone features

WARNING

Do not read or interact with notifications while driving, because doing so can cause distraction that could lead to an accident resulting in serious personal injury or death.

NOTICE

Garmin is not responsible for the accuracy or timeliness of the traffic information.

The Garmin Drive app allows your device to receive smart notifications and live information, such as live traffic data and weather information.

Live traffic data: sends live traffic data to your device, such as traffic incidents and delays, construction zones and road closings ([Traffic, page 37](#)).

Weather information: sends real-time weather forecasts, road conditions and weather radar to your device ([Viewing the Weather Forecast, page 50](#)).

Smart Notifications: displays phone notifications and messages on your device. This feature is not available for all languages.

Hands-Free calling: allows you to place and receive phone calls through the device using your connected Bluetooth headset.

Send locations to device: allows you to send locations from your smartphone to your navigation device.





Foursquare check in: allows you to check in to Foursquare locations using your navigation device ([Checking in with Foursquare, page 27](#)).

Bluetooth Feature status icons

Status icons appear in the Bluetooth settings next to each paired device.

Select **Settings > Wireless Networks**.

- A grey icon indicates the feature is disabled or disconnected for that device.
- A coloured icon indicates the feature is connected and active for that device.

	Hands-free calling
	Smart notifications
	Garmin Drive features and services
	Media streaming
	Headset is connected

Pairing Your Phone and Headset

The first time you turn on your device, you are prompted to pair your phone and headset. If necessary, you can complete setup at a later time by selecting **Settings > Complete Setup**. You must pair your zūmo device with your phone and Bluetooth headset to use several Bluetooth features. After the devices are paired, they connect automatically when they are turned on and within range.

Some features also require the Garmin Drive app. You can connect to the Garmin Drive app during the pairing process or later.

- 1 Place the zūmo device and your headset or phone within 3 m (10 ft.) of each other.
- 2 On your headset or phone, enable Bluetooth wireless technology and set your phone to be visible.
See the owner's manual for your headset or phone for more information.
- 3 On the zūmo device, select **Settings > Wireless Networks**.
- 4 If necessary, select the tick box to enable Bluetooth.
- 5 Select **Search for Devices** and choose your headset or phone from the list of nearby devices.
- 6 Follow the on-screen instructions to pair your headset or phone with your device.

Smart Notifications

While your device is connected to the Garmin Drive app, you can view notifications from your smartphone on your zūmo device, such as text messages, incoming calls, and calendar appointments.

NOTE: you may need to wait a few minutes to receive notifications on your navigation device after it connects to the Garmin Drive app.  appears coloured in the Bluetooth settings when smart notifications are connected and active ([Bluetooth Feature status icons, page 34](#)).

Receiving notifications

WARNING

Do not read or interact with notifications while driving, because doing so can cause distraction that could lead to an accident resulting in serious personal injury or death.

Before you can use this feature, your device must be connected to a supported phone running the Garmin Drive app ([Pairing Your Phone and Headset, page 34](#)).

From most pages, a pop-up appears when the device receives a notification from your smartphone. If the device is moving, you must verify you are a passenger and not the driver before you can view notifications.

NOTE: if you are viewing the map, notifications appear in a map tool.

- To ignore a notification, select **OK**.
The pop-up closes, but the notification remains active on your phone.
- To view a notification, select **View**.
- To listen to the notification, select **View > Play**.
The device reads the notification using text-to-speech technology. This feature is not available for all languages.
- To perform additional actions, such as dismissing the notification from your phone, select **View**, and select an option.

NOTE: additional actions are available for only some notification types and must be supported by the app generating the notification.

Receiving notifications while viewing the map

WARNING

Do not read or reply to notifications while driving. If you do so, you could become distracted by the display, which could lead to an accident causing serious personal injury or death.

Before you can use this feature, your device must be connected to a supported phone running the Garmin Drive app ([Pairing Your Phone and Headset, page 34](#)).

When you are viewing the map, new notifications appear in a map tool at the edge of the screen. If the device is moving, you must verify you are a passenger and not the driver before you can view notifications.

- To ignore a notification, select **X** or wait for popup to expire.
The pop-up closes, but the notification remains active on your phone.
- To view a notification, select the notification text.
- To listen to the notification, select **Play Message**.
The device reads the notification using text-to-speech technology. This feature is not available for all languages.
- To perform additional actions, such as dismissing the notification from your phone, select **View**, and select an option.

NOTE: additional actions are available for only some notification types and must be supported by the app generating the notification.

Viewing the list of notifications

You can view a list of all active notifications.

1 Select **Apps > Smart Notifications**.

The list of notifications appears. Unread notifications appear black, and previously read notifications appear grey.

2 Select an option:

- To view a notification, select the notification description.
- To listen to a notification, select .

The device reads the notification using text-to-speech technology. This feature is not available for all languages.

Hands-free calling

NOTE: while most phones and headsets are supported and can be used, a particular phone or headset cannot be guaranteed to be compatible. All features may not be available for your phone.

Using Bluetooth wireless technology, your device can connect to your compatible mobile phone and wireless headset or helmet to become a hands-free device. To check compatibility, go to www.garmin.com/bluetooth.

Placing a call

1 Select **Apps > Phone**.

2 Select an option:

- To dial a number, select **Dial**, enter the phone number and select **Dial**.
- To view numbers of recent, missed or recently dialed or received calls, select **Call History**, select a log, select a number and select **Call** to dial it.
- To call a contact from your phone book, select **Phone Book**, select a contact and select **Call**.
- To call a point of interest location such as a restaurant or attraction, select **Browse Categories**, select a category, select a location and select **Call**.

Calling home

Before you can call home, you must enter a phone number for your home location.

Select **Apps > Phone > Call Home**.

Placing a Call Using Voice Dial

1 Select **Apps > Phone > Voice Dial**.

2 Listen for the voice prompt.

3 Say **Call** and say the contact name, phone number or location you want to call.

Using in-call options

In-call options are available when you answer a call. Some options may not be compatible with your phone.

TIP: if you close the in-call options page, you can open it again by selecting  from any screen. You can also select the caller from the map.

- To set up a conference call, select **Add Call**.
- To transfer audio to your phone, select **Call in Prog on Navigator**.
TIP: you can use this feature if you want to disconnect the Bluetooth connection and remain on the call, or if you need privacy.
- To use the dial pad, select **Keypad**.
TIP: you can use this feature to use automated systems, such as voice mail.
- To mute the microphone, select **Mute**.
- To hang up, select **End Call**.

Setting up Bluetooth features for your Apple® device

By default, all compatible Bluetooth features are enabled when you pair your phone. You can enable, disable, or customise certain features.

Disabling Bluetooth features (iPhone)

By default, all compatible Bluetooth features are enabled when you pair your phone. You can disable specific Bluetooth features and remain connected to the other features.

- 1 Select **Settings** > **Wireless Networks**.
- 2 Select an option:
 - To disable all Bluetooth features, clear the Bluetooth tick box.
 - To disable hands-free calling, select the phone name and clear the **Phone calls** check box.

Setting up Bluetooth features for your smartphone with Android™

By default, all compatible Bluetooth features are enabled when you pair your phone. You can enable, disable, or customise certain features.

Disabling Bluetooth features (Android)

By default, all compatible Bluetooth features are enabled when you pair your phone. You can disable specific Bluetooth features and remain connected to the other features.

- 1 Select **Settings** > **Wireless Networks**.
- 2 Select an option:
 - To disable all Bluetooth features, clear the Bluetooth tick box.
 - To disable only hands-free calling, select the phone name and clear the **Phone calls** tick box.

Disconnecting a Bluetooth device

You can temporarily disconnect a Bluetooth device without deleting it from the paired devices list. The Bluetooth device can connect to your zūmo device automatically in the future.

- 1 Select **Settings** > **Wireless Networks**.
- 2 Select the device to disconnect.
- 3 Select **Disconnect**.

Deleting a paired phone

You can delete a paired phone to prevent it from automatically connecting to your device in the future.

- 1 Select **Settings** > **Wireless Networks**.
- 2 Select the phone, then select **Forget Device**.

Traffic

NOTICE

Garmin is not responsible for the accuracy or timeliness of the traffic information.

Your device can provide information about traffic on the road ahead or on your route. You can set your device to avoid traffic when calculating routes, and to find a new route to your destination if a large traffic delay occurs on your active route ([Traffic Settings, page 54](#)). The traffic map allows you to browse the map for traffic delays in your area.

To provide traffic information, your device must be receiving traffic data.

- All product models can receive subscription-free traffic data using the Garmin Drive app.

Traffic data is not available in all areas. For information about traffic coverage areas, go to garmin.com/traffic.

Receiving traffic data using your smartphone

Your device can receive subscription-free traffic data while connected to a smartphone running the Garmin Drive app.

- 1 Connect your device to the Garmin Drive app (*Pairing Your Phone and Headset, page 34*).
- 2 On your zūmo device, select **Settings** > **Traffic** and verify the **Traffic** check box is selected.

Receiving traffic data using a traffic receiver

NOTICE

Heated (metallised) windscreens could degrade the performance of the traffic receiver.

A traffic receiver receives traffic data from an over-the-air broadcast signal, where available. To receive over-the-air traffic data, the device must be connected to vehicle power using a traffic-compatible power cable. A traffic receiver is included with some product models (*Traffic, page 37*).

Traffic data is not available in all areas. For information about traffic coverage areas, go to garmin.com/traffic.

Connect the device to vehicle power using the traffic-compatible power cable (*Mounting Your Device in an Automobile, page 9*).

If your product model includes traffic data, the vehicle power cable included with your device is traffic-compatible.

When you are within a traffic coverage area, your device can display traffic information and help you avoid traffic delays.

Traffic Receiver Subscriptions

A regional traffic data subscription is included with most traffic receivers. You can add subscriptions for additional regions to your traffic receiver. For more information, go to garmin.com/traffic.

Viewing traffic subscriptions

Select **Settings** > **Traffic** > **Subscriptions**.

Adding a subscription

You can purchase traffic subscriptions for other regions or countries.

- 1 Select **Settings** > **Traffic**.
- 2 Select **Subscriptions** > **+**.
- 3 Write down the FM traffic receiver unit ID.
- 4 Go to garmin.com/fmtraffic to purchase a subscription and get a 25-character code.
The traffic subscription code cannot be reused. You must obtain a new code each time you renew your service. If you own multiple FM traffic receivers, you must obtain a new code for each receiver.
- 5 Select **Next** on the device.
- 6 Enter the code.
- 7 Select **Done**.

Viewing traffic on the map

The traffic map shows colour-coded traffic flow and delays on nearby roads.

- 1 From the main menu, select **Apps** > **Traffic**.
- 2 If necessary, select **≡** > **Legend** to view the legend for the traffic map.

Searching for traffic incidents

- 1 From the main menu, select **Apps** > **Traffic**.
- 2 Select **≡** > **Incidents**.
- 3 Select an item in the list.
- 4 If there is more than one incident, use the arrows to view additional incidents.

Using the apps

Group Ride

The Group Ride app allows you to coordinate rides and communicate with nearby riders using preset text messages, live map locations and voice communications.

NOTE: before you can use the Group Ride app, you must install a Group Ride accessory. Go to garmin.com to purchase a Group Ride accessory.

Starting a Group Ride

You can create a group ride that allows you to choose the group radio channel, view and remove riders who join your group ride and set the group ride name.

- 1 From the main menu, select **Group Ride > Start a Group Ride**.
- 2 Enter your rider name and select **Done**.
- 3 If necessary, select the radio channel and select **Next**.
- 4 Enter the ride name and select **Done**.

As riders join your group ride, their names appear on the list.

- 5 Select **Start**.

The group ride begins after all riders sync with the group ride.

Joining a Group Ride

You can join a nearby group ride that was created by another rider.

NOTE: for some product models, the Group Ride app is located in the apps menu.

- 1 From the main menu, select **Group Ride > Nearby Group Rides**.
- 2 Select a nearby group ride and select **Join**.

Rejoining a Recent Group Ride

You can rejoin any of your ten most-recent group rides.

- 1 From the main menu, select **Group Ride > Recent Group Rides**.
- 2 Select a recent group ride and select **Join**.

Adding Riders to a Group Ride

You can add riders to a group ride that is already in progress.

- 1 From the main menu, select **Group Ride**.
- 2 If necessary, select .
- 3 Select **Add**.

As new riders join the group ride, they appear on the list.

- 4 Select **Continue**.

Broadcasting a Message

WARNING

Do not read, send or reply to any messages while driving. If you do so, you could become distracted by the display, which could lead to an accident causing personal injury or death.

You can broadcast a preset message to the members in your active group ride that are in range of the VHF radio.

- 1 From the main menu, select **Group Ride**.
- 2 If necessary, select .
- 3 Select **Broadcast to Group**.
- 4 Select a preset message and select **Send**.

Broadcasting a Location

WARNING

While driving, do not interact with the display to broadcast your location. If you do so, you could become distracted by the display, which could lead to an accident causing serious personal injury or death.

You can broadcast a location to the members in your active group ride that are in range of the VHF radio.

- 1 From the main menu, select **Group Ride**.
- 2 If necessary, select .
- 3 Select **Broadcast to Group > Broadcast a Location** and select a location.
- 4 Select **Share**.

Viewing a Group Ride Notification

WARNING

Do not read or reply to any notifications while driving. If you do so, you could become distracted by the display, which could lead to an accident causing serious personal injury or death.

From most pages, a notification appears when the device receives a broadcasted group ride location or message. You can also view group ride notifications in the Group Ride app.

NOTE: when you are viewing the map, new notifications appear in a map tool at the edge of the screen..

- 1 From the main menu, select **Group Ride > ** and select a notification.
- 2 Select **Go!** to navigate to a shared location.

Exiting a Group Ride

- 1 From the main menu, select **Group Ride**.
- 2 If necessary, select .
- 3 Select **Exit > Continue**.

Group Ride Settings

From the main menu, select **Group Ride > **.

Edit Rider Name: allows you to set your name that displays during a group ride. This setting is not available during an active group ride.

Rider Map Labels: sets the label to be displayed on each active rider on the map.

Show Tracks on Map: shows the track that each group ride member takes on the map.

Auto Zoom to Group: enables the map to automatically zoom to the active group ride.

Reset Default Settings: allows you to reset all group ride settings to default values. This setting is not available during an active group ride.

Radio

NOTE: this feature is not available on all product models.

You can use the radio app to create radio presets, select a radio channel and select squelch codes. To use this feature, you must connect the device and the antenna to the Group Ride mount. The zūmo device configures radio settings automatically when you join or create a group ride.

Selecting a Preset

NOTE: for some product models, the Radio app is located in the apps menu.

- 1 From the main menu, select **Radio**.
- 2 Select an option:
 - To move through available presets, select ▲ or ▼.
 - To select a preset from the menu, select **Preset**.

Selecting a Radio Channel

- 1 From the main menu, select **Radio**.
- 2 Select an option:
 - To move to a different channel, select + or -.
 - To select a MURS channel from the menu, select **Channel**.

Adjusting the Squelch

You can adjust the squelch and change between CTCSS, DCS and Open squelch modes to improve audio quality and avoid radio interference in your area.

- 1 From the main menu, select **Radio**.
- 2 Select an option:
 - To choose a squelch code within the current mode, select + or -.
 - To adjust the squelch mode, select **Open**.

Adding a Custom Radio Preset

- 1 Select **Radio** > **Preset** > (+).
- 2 Select + or - to select a channel and squelch code.
- 3 Select **Save**.

Selecting a Roger Tone

You can select the tone other devices play when you operate your radio.



- 1 Select **Radio** > 🔑 > **Roger Tone**.
- 2 Select a roger tone.
The device plays the selected tone.
- 3 Select **Save**.

Turning the Radio Off

Select **Radio** > 🔌 > **Continue**.

Enabling Push-to-Talk with a Headset

You can enable push-to-talk controls for use with a compatible Bluetooth headset. This allows you to transmit your voice using the voice dial feature on your headset.

- 1 Select **Radio** >  > **Push to Talk Over Headset**.
- 2 If necessary, follow the on-screen instructions to pair your headset with the device.
- 3 Select **Push to Talk Over Headset**.
- 4 Select .

Transmitting Your Voice

Before you can transmit your voice, you must pair your zūmo device with a compatible Bluetooth headset or connect the fist microphone.

You can transmit your voice over the radio using the connected fist microphone or a compatible Bluetooth headset.

NOTE: for some product models, the Radio app is located in the apps menu.

Select an option:

- Hold the push-to-talk button on the side of the connected fist microphone.
- From the main menu, select **Radio** > **Push to Talk**.
- Use the voice dial feature on your connected Bluetooth headset ([Enabling Push-to-Talk with a Headset, page 42](#)).

TIP: you can press the pause or stop button to manually close the radio.

NOTE: you must enable the **Push to Talk Over Headset** setting to use this feature ([Radio Settings, page 42](#)).

Adjusting the Radio Volume

- 1 Select **Radio** > .
- 2 Use the slider bars to adjust the volume.

Radio Settings

From the main menu, select **Radio** > .



Push to Talk Over Headset: enables you to transmit your voice using the push-to-talk button on your compatible headset.

Roger Tone: sets the roger tone the device plays when you operate your radio.

Reset Default Settings: resets all radio settings and presets to factory default values.

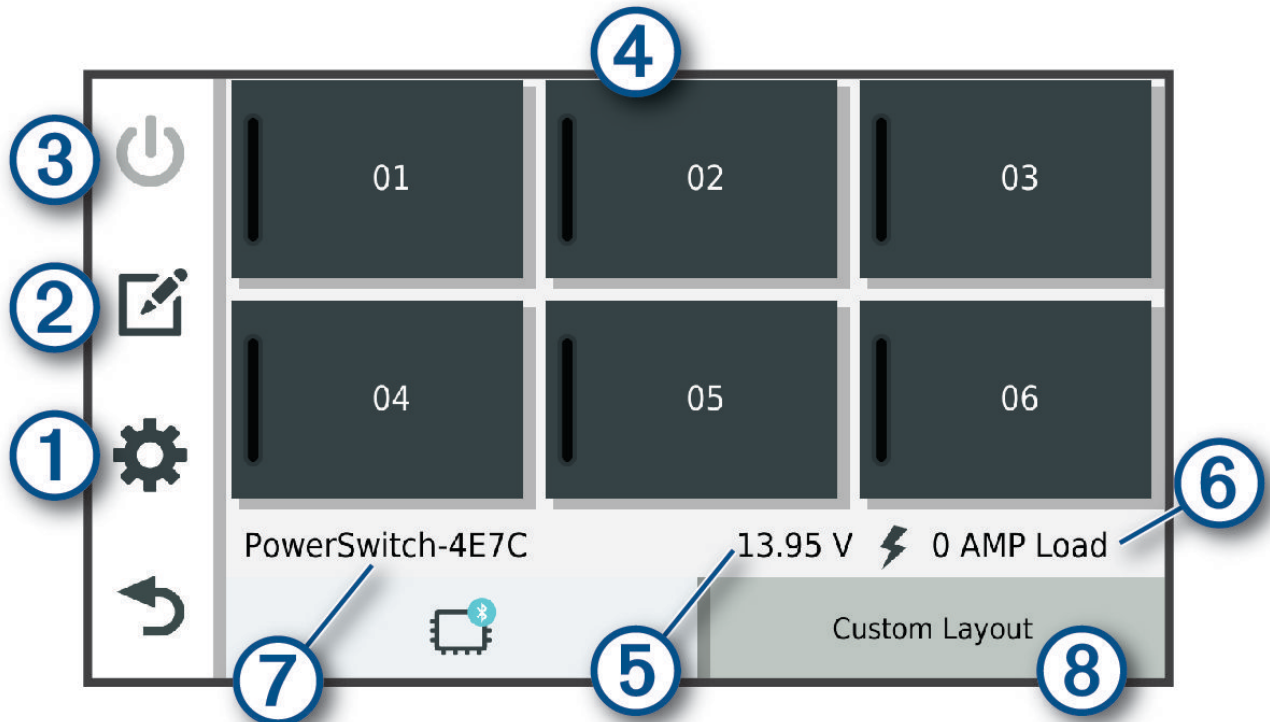
Garmin PowerSwitch™ App



① 	Opens the app settings menu
② 	Enters editing mode to customise the app layout and functions
③ 	Turns off all outputs
④ Power buttons	Activates each connected output
⑤	Displays input voltage
⑥	Displays the total amperage of the selected Garmin PowerSwitch device
⑦	Displays the device name
⑧	Displays Garmin PowerSwitch device tabs and custom layout tabs

Activating a Power Switch



Before you can use the Garmin PowerSwitch app to activate a switch, you must install your Garmin PowerSwitch device in your vehicle and pair it with the Garmin PowerSwitch app.

From the Garmin PowerSwitch app, select a power button to turn a switch on or off.

Turning Off All Switches

Select .

Customising a Button

- 1 From the Garmin PowerSwitch app screen, select .
The app enters editing mode.
- 2 Select  on the button you want to customise.
- 3 Select an option:
 - To change the name of the button, select the **Button Label** field and enter a name.
 - To add an icon to the button, select the **Icon** field and select an icon.
 - To change the button colour, select a colour.
 - To change the button mode, select a button mode.
 - To adjust the intensity of the switch, use the slider.
 - To set the button to activate with a control input, select a control input.
- 4 Select .
- 5 Select **Done**.

Assigning a Switch to a Control Input



Before you can use control input functions, you must connect a control input to your Garmin PowerSwitch device ([Connecting a Control Input, page 64](#)).

You can assign one or more switches to turn on when the Garmin PowerSwitch device receives a signal from a control input.



- 1 Select .
- 2 Select your Garmin PowerSwitch device.
- 3 Select a control input.
- 4 Select one or more switches.

Adding a Custom Layout



You can add a custom layout tab to the Garmin PowerSwitch app. Buttons added to a custom layout can control multiple switches at the same time.

- 1 From the Garmin PowerSwitch app, select .
The device enters editing mode.
- 2 Select .



Adding a Button to a Custom Layout

- 1 From the Garmin PowerSwitch app, select a custom layout tab.
- 2 Select .
The app enters editing mode.
- 3 Select **Add Button**.
- 4 On the new button, select .
- 5 Select an option:
 - To change the name of the button, select the **Button Label** field and enter a name.
 - To add an icon to the button, select the **Icon** field and select an icon.
 - To change the button colour, select a colour.
- 6 Select **Add Action**.
- 7 If necessary, select a Garmin PowerSwitch device and a switch.
- 8 Select an action:
 - To set the button to turn the switch on or off with each press, select **Toggle**.
 - To set the button to turn on the switch, select **Turn On**.
 - To set the button to turn off the switch, select **Turn Off**.
- 9 Select a button mode:
 - To set the button to activate with one touch, select **Normal**.
 - To set the button to activate only while touching the button, select **Momentary**.
 - To set the button to turn on and off repeatedly, select **Strobe** and select time intervals.
- 10 If applicable, use the slider to set the brightness of lights.
- 11 Select .
- 12 If necessary, select **Add Action** to add additional actions to the button.
You can add one action for every switch on the Garmin PowerSwitch device.

Arranging Buttons In a Custom Layout

- 1 From the Garmin PowerSwitch app, select a custom layout tab.
- 2 Select .
The app enters editing mode.
- 3 On the button you want to move, hold  and drag the button to a new location.

Deleting a Custom Layout or Button

- 1 From the Garmin PowerSwitch app, select a custom layout tab.
- 2 Select .
The app enters editing mode.
- 3 Select an option:
 - To delete a button, select  on the button you want to delete.
 - To delete a layout tab, select  on the layout tab.

Routines

Routines automate your Garmin PowerSwitch device. When you define a routine on your compatible Garmin navigation device, it turns switches on or off automatically when the conditions of the routine are met. For example, you can set a routine to turn on a switch at specific time each day or when your vehicle reaches a specific speed. Routines are available only when using a compatible Garmin navigation device.

Adding a Routine

- 1 From the Garmin PowerSwitch app, select  > **Routines**.
- 2 If necessary, select **Add Routine**.
- 3 Select **When**.
- 4 Select a trigger:
 - To set a switch to trigger when your vehicle reaches a specific speed, select **Speed** > **Next** and follow the on-screen instructions to enter speed thresholds.
 - To set a switch to trigger at a specific time each day, select **Time** > **Next** and enter a time.
 - To set a switch to trigger at sunrise, select **Sunrise**.
 - To set a switch to trigger at sunset, select **Sunset**.
- 5 Select **Add Action**.
- 6 Select a device, a switch, an action and a button mode.
- 7 If necessary, use the slider to adjust the dimmer.
- 8 Select **Save**.

Editing a Routine

- 1 From the Garmin PowerSwitch app, select  > **Routines**.
- 2 Select on the routine you want to edit.
- 3 Select an option:
 - To change the trigger for the routine, select **When** and select a trigger.
 - To change an action, select on the action you want to change and update the action.
 - To add an action to the routine, select **Add Action** and enter information about the action.
- 4 Select **Save**.

Deleting a Routine

- 1 From the Garmin PowerSwitch app, select  > **Routines**.
- 2 Select on the routine you want to delete.

Viewing the Owner's Manual on Your Device

You can view the complete owner's manual on the device screen in many languages.

- 1 Select **Apps** > **Owner's Manual**.
The owner's manual appears in the same language as the software text.
- 2 Select  to search the owner's manual (optional).

Media player

The media player can play music or audio from these sources.

- Music files stored on your zūmo device.
- Bluetooth audio from a paired phone.

Adding the Music Player Tool to the Map

The music player map tool enables you to control the music player from your map.

- 1 Open the map.
- 2 Select  > **Music Player**.
The music player controls appear on the map.

Changing the Media Source

You can change the source from which media is played on your device.

- 1 Select **Music**.
- 2 Select the current media source ①.

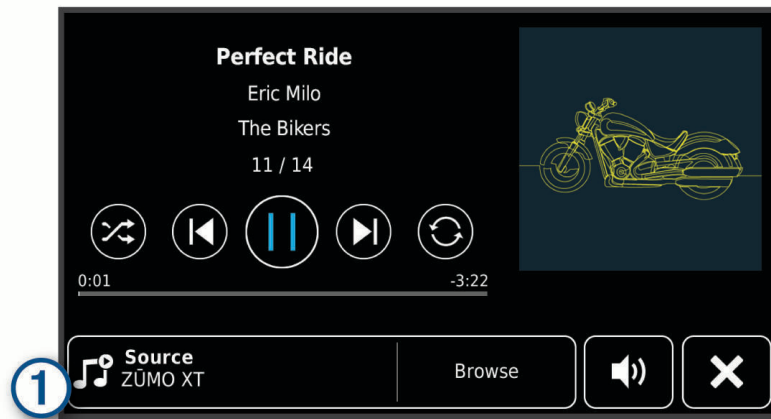

- 3 Select an available media source from the list.

BirdsEye Imagery

BirdsEye imagery provides downloadable, high-resolution map imagery, including detailed satellite imagery and raster-based topographical maps. You can download BirdsEye imagery directly to your device when it is connected to a Wi-Fi network.

Downloading BirdsEye Imagery

Before you can download BirdsEye imagery directly to your device, you must connect to a wireless network ([Connecting to a Wi-Fi Network, page 57](#)).

- 1 Select **BirdsEye Direct**.
- 2 Select **↓**.
- 3 Select an option:
 - To download BirdsEye imagery files for a specific location or area, select **Location** and select a category.
NOTE: the location defaults to your current location.
 - To select an image quality option, select **Detail**.
 - To define the size of the area to be shown in the downloaded imagery files, select **Size** and enter a distance from the selected location.
 - To select where to save the downloaded imagery, select **Save to**.
- 4 Select **Download**.
- 5 Enter a name for the downloaded imagery and select **Done**.

Trip planner



You can use the trip planner to create and save a trip, which you can navigate later. This can be useful for planning a delivery route, a vacation, or a road trip. You can edit a saved trip to further customise it, including reordering locations, optimising the order of stops, adding suggested attractions and adding shaping points. You can also use the trip planner to edit and save your active route.

Planning a trip

A trip can include many locations, and it must include at least a starting point and a destination. The starting point is the location from which you plan to start your trip. If you start navigating the trip from a different location, the device gives you the option to route to your starting point first. For a round trip, the starting location and final destination can be the same.

- 1 Select **Apps > Trip Planner > New Trip**.
- 2 Select **Select Start Location**.
- 3 Choose a location for your starting point, and select **Select**.
- 4 Select **Select Destination**.
- 5 Choose a location for a destination, and select **Select**.
- 6 Select **Add Location** to add more locations (optional).
- 7 After you have added all the necessary locations, select **Next > Save**.
- 8 Enter a name and select **Done**.

Editing and reordering locations in a trip

- 1 Select **Apps > Trip Planner > Saved Trips**.
- 2 Select a saved trip.
- 3 Select a location.
- 4 Select an option:
 - To move the location up or down, select , and drag the location to a new position in the trip.
 - To add a new location after the selected location, select .
 - To remove the location, select .

Optimising the order of stops in a trip

The device can automatically optimise the order of stops in your trip to create a shorter, more efficient route. The starting location and final destination are not changed when you optimise the order.

While editing a trip, select  > **Optimise Order**.

Discovering Attractions Along Your Trip

The device can suggest interesting or popular attractions to add to your trip.

- 1 While editing a trip, select  > **Suggest Attractions**.
- 2 Select an attraction to view more information.
- 3 Select **Select** to add the attraction to your trip.

Changing routing options for a trip

You can customise how the device calculates the route when you start your trip.

- 1 Select **Apps > Trip Planner > Saved Trips**.
- 2 Select a saved trip.
- 3 Select the vehicle profile icon, and select the vehicle you plan to use while navigating the trip (optional).
- 4 Select .
- 5 Select **Route Preference** to change the calculation mode for the trip (*Changing the route calculation mode*, page 14).

Navigating to a favourite trip

- 1 Select **Apps** > **Trip Planner** > **Saved Trips**.
- 2 Select a saved trip.
- 3 Select **Go!**.
- 4 Select the first location to navigate to, and select **Start**.

The device calculates a route from your current location to the selected location, and then it guides you to the remaining trip destinations in order.

Sharing a Route

You can share routes with other zūmo devices.

- 1 Select **Apps** > **Share Route**.
- 2 Select an option:
 - To share a route using Garmin Drive, select **Garmin Drive™**.
 - To share a route using a Bluetooth connection, select **Bluetooth**.
 - To copy the route to a microSD card, select **Memory Card**.
- 3 Select a route.
- 4 Select **Done**.
- 5 Follow the on-screen instructions on your zūmo device to complete the sharing process.

Tracks

A track is a recording of your path. The track log contains information about the recorded path, including time, location, and elevation information.

Recording Tracks

Tracking records your path. When you start tracking, your device logs your location and updates the track. If your device is paired with a Garmin Explore account, your device periodically synchronises recorded tracks with the app.

- 1 From the main screen, select **Track**.
- 2 Select **Start**.

TracBack[®]

Following your recent track

The TracBack feature records the most recent segment of your movement. You can retrace your recent track back to a previous location.

- 1 Select **Apps** > **TracBack**.
Your recent track appears on the map.
- 2 Select **Go!**.

Saving your recent track as a trip

You can save your recent track as a trip, which you can navigate later using the trip planner ([Navigating to a favourite trip, page 49](#)).

- 1 Select **TracBack**.
Your recent track appears on the map.
- 2 Select  > **Save as Trip**.
- 3 Enter a name and select **Done**.

Logging service history

You can log the date and odometer reading when service or maintenance is performed on your vehicle. The device provides several service categories, and you can add custom categories ([Adding service categories, page 50](#)).

- 1 Select **Apps > Service History**.
- 2 Select a service category.
- 3 Select **Add Record**.
- 4 Enter the odometer reading, and select **Next**.
- 5 Enter a comment (optional).
- 6 Select **Done**.

Adding service categories

- 1 Select **Apps > Service History**.
- 2 Select  **> Add Category**.
- 3 Enter a category name, and select **Done**.

Viewing the Weather Forecast

NOTICE

Garmin is not responsible for the accuracy or timeliness of the weather data.

Before you can use this feature, your device must be receiving weather data. You can connect your device to the Garmin Drive app to receive weather data ([Pairing Your Phone and Headset, page 34](#)).

- 1 Select **Apps > Weather**.
The device shows the current weather conditions and a forecast for the next several days.
- 2 Select a day.
The detailed forecast for that day appears.

Viewing weather near a different town

- 1 Select **Apps > Weather > Current Location**.
- 2 Select an option:
 - To view weather for a favourite town, select a town in the list.
 - To add a favourite town, select **Add Town**, and enter a town name.

Viewing the weather radar

Before you can use this feature, your device must be connected to a supported phone running the Garmin Drive app ([Pairing Your Phone and Headset, page 34](#)).

- 1 Select **Apps > Weather Radar**.
- 2 Select  to animate the radar map.

Viewing weather alerts

Before you can use this feature, your device must be connected to a supported phone running the Garmin Drive app ([Pairing Your Phone and Headset, page 34](#)).

NOTE: this feature is not available in all areas.

While you are travelling with your device, weather alerts may appear on the map. You can also view a map of weather alerts near your current location or near a selected town.

- 1 Select **Apps > Weather**.
- 2 If necessary, select a town.
- 3 Select  **> Weather Alerts**.

Checking road conditions



Before you can use this feature, your device must be connected to a supported phone running the Garmin Drive app ([Pairing Your Phone and Headset, page 34](#)).

You can view weather-related road conditions for the roads in your area, on your route or in another town.

- 1 Select **Apps > Weather**.
- 2 If necessary, select a town.
- 3 Select  > **Road Conditions**.

Creating a Round-Trip Route

The device can create a round-trip route using a specified starting location and a distance, duration or destination.

- 1 From the main menu, select **Apps > Round Trip**.
- 2 Select **Start Location**.
- 3 Select a location, and select **Select**.
- 4 Select **Trip Attributes**.
- 5 Select an option:
 - Select **Choose a Distance** to plan your route by distance.
 - Select **Choose a Duration** to plan your route based on time.
 - Select **Choose a Destination** to plan your route based on a specified location.
- 6 Select **Next**.
- 7 Enter a distance, duration or destination.
- 8 Select an option:
 - If you entered a distance or duration, select **Done**.
 - If you selected a destination, select **Select**.
- 9 Select **Add a Direction**.
- 10 Select a direction and select **Next**.
- 11 Select **Calculate**.
- 12 Select one or more options:
 - Select  to view elevation statistics along your route.
 - Select  to shape your route.
 - Use the slider to increase or decrease the level of adventure on your route.
- 13 Select a route, and select **Go!**.

photoLive traffic cameras

Before you can use this feature, your device must be connected to the Garmin Drive app ([Pairing Your Phone and Headset, page 34](#)).

photoLive traffic cameras provide live images of traffic conditions on major roads and junctions.

The photoLive service is not available in all areas.

Viewing and Saving photoLive Traffic Cameras

You can view live images from nearby traffic cameras. You can also save traffic cameras for areas you travel frequently.

1 Select **Apps > photoLive**.

2 Select **Touch to Add**

3 Select a road.

4 Select a traffic camera location.

A preview of the live image from the camera appears next to a map of the camera's location. You can select the image preview to view the full-sized image.

5 Select **Save** to save the camera (optional).

A thumbnail image preview of the camera is added to the main screen of the photoLive app.

Viewing photoLive Traffic Cameras on the Map

The photoLive map tool shows traffic cameras from the road ahead of you.

1 From the map, select **☰ > photoLive**.

The device shows the live image from the nearest traffic camera on the road ahead, along with the distance to the camera. When you pass the camera, the device loads the live image of the next camera on the road.

2 If no cameras are found for the road, select **Find Cameras** to view or save nearby traffic cameras (optional).

Viewing Previous Routes and Destinations

Before you can use this feature, you must enable the travel history feature (*Device and privacy settings, page 55*).

You can view your previous routes and places where you have stopped on the map.

Select **Apps > Where I've Been**.

zūmo settings

Map and vehicle settings

Select **Settings > Map & Vehicle**.

Vehicle: sets the vehicle icon that represents your position on the map.

Driving Map View: sets the perspective on the map.

Map Detail: sets the level of detail on the map. More detail may cause the map to be drawn more slowly.

Map Theme: changes the colour of the map data.

Map Layers: sets the data that appears on the map page (*Customising the map layers, page 32*).

Auto Zoom: automatically selects the zoom level for optimal use of your map. When disabled, you must zoom in or out manually.

Skip Next Stop Confirmation: sets a confirmation message to appear when skipping a location on your route.

myMaps: sets which installed maps the device uses.

Enabling maps

You can enable map products installed on your device.

TIP: to purchase additional map products, go to <http://buy.garmin.com>.

1 Select **Settings > Map & Vehicle > myMaps**.

2 Select a map.

Navigation settings

Select **Settings > Navigation**.

Calculation Mode: sets the route calculation method.

Off-Route Recalculation: sets recalculation preferences when navigating away from an active route.

Avoidances: sets road features to avoid on a route.

Custom Avoidances: allows you to avoid specific roads or areas.

Toll Roads: sets preferences for avoiding toll roads.

Tolls and Fees: sets preferences for avoiding toll roads and toll stickers.

NOTE: this feature is not available in all areas.

Environmental Zones: sets the avoidance preferences for areas with environmental or emissions restrictions that may apply to your vehicle.

Restricted Mode: disables all functions that require significant operator attention.

GPS Simulator: stops the device from receiving a GPS signal and saves battery power.

Calculation Mode Settings

Select **Settings > Navigation > Calculation Mode**.

The route calculation is based on road speeds and vehicle acceleration data for a given route.

Faster Time: calculates routes that are faster to drive but can be longer in distance.

Shorter Distance: calculates routes that are shorter in distance but can take more time to drive.

Straight Line: calculates a direct line from your location to your destination.

Setting a simulated location

If you are indoors or not receiving satellite signals, you can use the GPS simulator to plan routes from a simulated location.

1 Select **Settings > Navigation > GPS Simulator**.

2 From the main menu, select **View Map**.

3 Tap the map twice to select an area.

The address of the location appears at the bottom of the screen.

4 Select the location description.

5 Select **Set Location**.

Bluetooth settings

Select **Settings > Wireless Networks**.

Bluetooth: enables Bluetooth wireless technology.

Search for Devices: searches for nearby Bluetooth devices.

Friendly Name: allows you to enter a friendly name that identifies your device on other devices with Bluetooth wireless technology.

Wi-Fi settings

The wireless network settings allow you to manage Wi-Fi networks.

Select **Settings > Wireless Networks**.

Wi-Fi: enables the Wi-Fi radio.

Saved Networks: allows you to edit or remove saved networks.

Search for Networks: searches for nearby Wi-Fi networks ([Connecting to a Wi-Fi Network, page 57](#)).

Driver Assistance Settings

Select **Settings > Driver Assistance**.

Rider Alerts: allows you to enable or disable alerts for upcoming zones or road conditions (*Rider Awareness Features and Alerts, page 10*).

Speeding Alert: alerts you when you are exceeding the speed limit.

Route Preview: shows a preview of the major roads in your route when you start navigation.

Break Planning: reminds you to take a break and shows upcoming services after you drive for an extended time. You can enable or disable break reminders and upcoming service suggestions.

Automatic Incident Detection: enables the device to detect a possible vehicle incident.

Incident Notification: allows you to set up a contact to be notified when the device detects a possible vehicle incident.

Proximity Alerts: alerts you when you approach speed cameras or red light cameras.

Display settings

Select **Settings > Display**.

Orientation: allows you to set the display to portrait (vertical) or landscape (horizontal).

NOTE: this feature is not available on all product models.

Colour Mode: allows you to select day or night colour mode. If you select the Auto option, the device automatically switches to day or night colours based on the time of day.

Brightness: allows you to adjust the display brightness.

Display Timeout: allows you to set the amount of idle time before your device enters sleep mode while using battery power.

Screenshot: allows you to take a picture of the device screen. Screenshots are saved in the Screenshot folder of the device storage.

Traffic Settings

From the main menu, select **Settings > Traffic**.

Traffic: enables traffic.

Current Provider: sets the traffic provider to use for traffic data. The Auto option selects the best available traffic data automatically.

Subscriptions: lists the current traffic subscriptions.

Optimise Route: enables the device to use optimised alternative routes automatically or upon request (*Avoiding traffic delays on your route, page 19*).

Traffic Alerts: sets the traffic delay severity for which the device displays a traffic alert.

Units and time settings

To open the Units and Time settings page, from the main menu, select **Settings > Units & Time**.

Current Time: sets the device time.

Time Format: allows you to select a 12-hour, 24-hour or UTC display time.

Units: sets the unit of measure used for distances.

Position Format: sets the co-ordinate format and datum used for geographical co-ordinates.

Setting the Time

1 From the main menu, select the time.

2 Select an option:

- To set the time automatically using GPS information, select **Automatic**.
- To set the time manually, drag the numbers up or down.

Language and Keyboard Settings

To open the Language and Keyboard settings, from the main menu, select **Settings > Language & Keyboard**.

Voice Language: sets the language for voice prompts.

text language: sets all on-screen text to the selected language.

NOTE: changing the text language does not change the language of user-entered data or map data, such as street names.

Keyboard language: enables keyboard languages.

Device and privacy settings

Select **Settings > Device**.

About: displays the software version number, the unit ID number and information on several other software features.

Regulatory: displays regulatory markings and information.

EULAs: displays the end-user licence agreements.

NOTE: you need this information when you update the system software or purchase additional map data.

Software Licences: displays software licensing information.

Device Data Reporting: shares anonymous data to improve the device.

Travel History: allows the device to store a record of the places you go. This allows you to view the trip log, use the Where I've been feature and use myTrends™ suggested routes.

Reset: allows you to clear your travel history, reset settings or delete all user data.

Restoring settings

You can restore a category of settings or all settings to the factory default values.

- 1 Select **Settings**.
- 2 If necessary, select a settings category.
- 3 Select  > **Restore**.

Device information

Viewing E-label Regulatory and Compliance Information

- 1 From the settings menu, swipe to the bottom of the menu.
- 2 Select **Device > Regulatory**.

Specifications

Water resistance	IEC 60529 IPX7 ¹
Operating temperature range	From -15° to 55°C (from 5° to 131°F)
Charging temperature range	From 0° to 45°C (from 32° to 113°F)
Power input (vehicle power cable, motorcycle or external power)	From 12 to 24 Vdc
Battery type	Lithium-ion battery
Battery voltage range	From 3.5 to 4.1 V
Wireless frequencies/protocols	Wi-Fi: 2.4 GHz @ 18 dBm maximum or 5 GHz @ 15 dBm nominal Bluetooth: 2.4 GHz @ 4 dBm nominal

Charging the Device

NOTE: this Class III product shall be powered by an LPS power supply.

You can charge the battery in the device using any of these methods.

- Install the device in the mount, and connect the mount to vehicle power.

NOTICE

Do not connect the device directly to the vehicle power cable.

- Connect the device to an optional power adapter accessory, such as a wall power adapter.
You can purchase an approved Garmin AC-DC adapter suitable for home or office use from a Garmin dealer or www.garmin.com. The device may charge slowly when connected to a third-party adapter.

Device maintenance

Garmin Support Centre

Go to support.garmin.com for help and information, such as product manuals, frequently asked questions, videos and customer support.

Map and Software Updates

For the best navigation experience, you should keep the maps and software on your device up to date.

Map updates provide the newest available changes to roads and locations in the maps used by your device. Keeping maps up to date helps your device find recently added locations and calculate more accurate routes. Map updates are large and may take several hours to complete.

Software updates provide changes and improvements to the device features and operation. Software updates are small and take a few minutes to complete.

You can update your device using two methods.

- You can connect the device to a Wi-Fi network to update directly on the device (recommended). This option allows you to update your device conveniently without connecting it to a computer.
- You can connect the device to a computer and update it using the Garmin Express application (garmin.com/express).

¹*The device withstands incidental exposure to water of up to 1 m for up to 30 min. For more information, go to www.garmin.com/waterrating.

Connecting to a Wi-Fi Network

The first time you turn on the device, it prompts you to connect to a Wi-Fi network and register your device. You can also connect to a Wi-Fi network using the settings menu.

- 1 Select **Settings > Wireless Networks**.
- 2 If necessary, select **Wi-Fi** to enable Wi-Fi technology.
- 3 Select **Search for Networks**.
The device displays a list of nearby Wi-Fi networks.
- 4 Select a network.
- 5 If necessary, enter the password for the network, and select **Done**.

The device connects to the network, and the network is added to the list of saved networks. The device reconnects to this network automatically when it is within range.

Updating Maps and Software Using a Wi-Fi Network

NOTICE

Map and software updates may require the device to download large files. Regular data limits or charges from your Internet service provider apply. Contact your Internet service provider for more information about data limits or charges.

You can update the maps and software by connecting your device to a Wi-Fi network that provides access to the Internet. This allows you to keep your device up to date without connecting it to a computer.

- 1 Connect the device to a Wi-Fi network ([Connecting to a Wi-Fi Network, page 57](#)).
While connected to a Wi-Fi network, the device checks for available updates. When an update is available,  appears on the Settings icon in the main menu.
- 2 Select **Settings > Updates**.
The device checks for available updates. When an update is available, **Update Available** appears below Map or Software.
- 3 Select an option:
 - To install all available updates, select **Install All**.
 - To install only map updates, select **Map > Install All**.
 - To install only software updates, select **Software > Install All**.
- 4 Read the licence agreements, and select **Accept All** to accept the agreements.
NOTE: if you do not agree with the licence terms, you can select **Reject**. This stops the update process. You cannot install updates until you accept the licence agreements.
- 5 Using the included USB cable, connect the device to external power and select **Continue** ([Charging the Device, page 56](#)).
For the best results, a USB wall charger that provides at least 1 A power output is recommended. Many USB power adapters for smartphones, tablets, or portable media devices may be compatible.
- 6 Keep the device connected to external power and within range of the Wi-Fi network until the update process is complete.

TIP: if a map update is interrupted or cancelled before it completes, your device may be missing map data. To repair missing map data, you must update the maps again using either Wi-Fi or Garmin Express.

Product updates

On your computer, install Garmin Express (www.garmin.com/express).

This provides easy access to these services for Garmin devices:

- Software updates
- Map updates
- Product registration

Updating Maps and Software with Garmin Express

You can use the Garmin Express application to download and install the latest map and software updates for your device.

- 1 If you do not have the Garmin Express application installed on your computer, go to garmin.com/express and follow the on-screen instructions to install it.
- 2 Open the  Garmin Express application.
- 3 Connect your device to your computer using a mini-USB cable.

The small end of the cable connects to the mini-USB port  on your zūmo device and the large end connects to an available USB port on your computer.

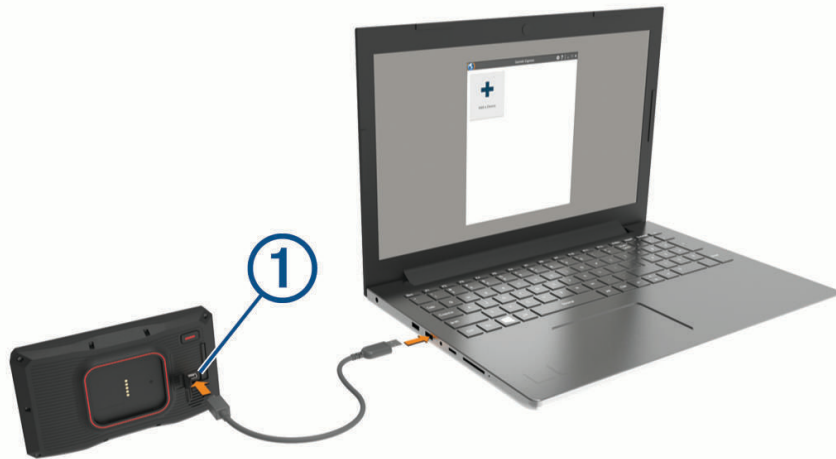

- 4 When your zūmo device prompts you to enter file transfer mode, select **Continue**.
- 5 In the Garmin Express application, click **Add a Device**.
The Garmin Express application searches for your device and displays the device name and serial number.
- 6 Click **Add Device** and follow the on-screen instructions to add your device to the Garmin Express application.
When setup is complete, the Garmin Express application displays the updates available for your device.

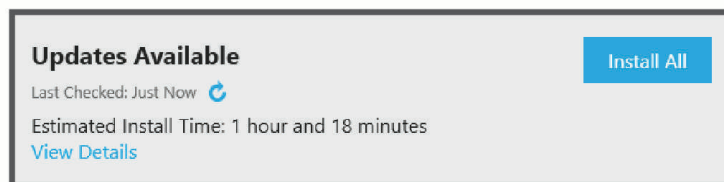

- 7 Select an option:
 - To install all available updates, click **Install All**.
 - To install a specific update, click **View Details** and click **Install** next to the update you want.The Garmin Express application downloads and installs the updates onto your device. Map updates are very large and this process may take a long time on slower internet connections.
NOTE: if a map update is too large for the internal storage of the device, the software may prompt you to install a microSD card in your device to add storage space (*Installing a memory card for maps and data*, page 69).
- 8 Follow the on-screen instructions during the update process to finish installing updates.
For example, during the update process, the Garmin Express application may instruct you to disconnect and reconnect your device.

Device Care

NOTICE

Avoid dropping your device.

Do not store the device where prolonged exposure to extreme temperatures can occur, as it can cause permanent damage.

Never use a hard or sharp object to operate the touchscreen as this may result in damage.

Cleaning the outer casing

NOTICE

Avoid chemical cleaners and solvents that can damage plastic components.

- 1 Clean the outer casing of the device (not the touchscreen) using a cloth dampened with a mild detergent solution.
- 2 Wipe the device dry.

Cleaning the Touchscreen

- 1 Use a soft, clean, lint-free cloth.
- 2 If necessary, lightly dampen the cloth with water.
- 3 If using a dampened cloth, turn off the device and disconnect the device from the power.
- 4 Gently wipe the screen with the cloth.

Avoiding theft

- Remove the device and mount from sight when not in use.
- Remove the residue left on the windscreen by the suction cup.
- Do not keep your unit in the glove compartment.
- Register your device using the Garmin Express software (garmin.com/express).

Restarting the Device

You can restart your device if it stops functioning.

Hold the power key for 12 seconds.

Removing the Device, Mount and Suction Cup

Removing the Device from the Mount

- 1 Press the release tab or button on the mount.
- 2 Tilt the bottom of the device upward, and lift the device from the mount.

Removing the Mount from the Suction Cup

- 1 Turn the device mount to the right or left.
- 2 Apply pressure until the socket on the mount releases the ball on the suction cup.

Removing the Suction Cup from the Windscreen

- 1 Flip the lever on the suction cup towards you.
- 2 Pull the tab on the suction cup towards you.

Changing the Fuse in the Vehicle Power Cable

NOTICE

When replacing the fuse, do not lose any of the small pieces and make sure they are put back in the proper position. The vehicle power cable does not work unless it is assembled correctly.

If your device does not charge in your vehicle, you may need to replace the fuse located at the tip of the vehicle adapter.

- 1 Rotate the end piece ① anti-clockwise to unlock it.

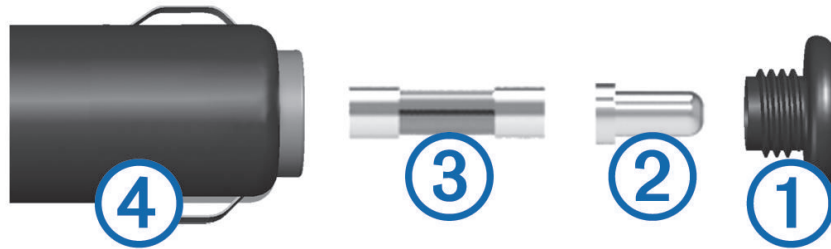

TIP: you may need to use a coin to remove the end piece.

- 2 Remove the end piece, the silver tip ② and the fuse ③.
- 3 Insert a new fast-blow fuse that has the same current, such as 1 A or 2 A.
- 4 Place the silver tip in the end piece.
- 5 Push in the end piece and rotate it clockwise to lock it back into the vehicle power cable ④.

Troubleshooting

The suction cup will not stay on my windscreen

- 1 Clean the suction cup and windscreen with surgical spirit.
- 2 Dry with a clean, dry cloth.
- 3 Mount the suction cup (*Mounting Your Device in an Automobile, page 9*).

My device is not acquiring satellite signals

- Verify the GPS simulator is turned off (*Navigation settings, page 53*).
- Take your device out of multi-storey car parks and away from tall buildings and trees.
- Remain stationary for several minutes.

My battery does not stay charged for very long

- Decrease the screen brightness (*Display settings, page 54*).
- Shorten the display timeout (*Display settings, page 54*).
- Decrease the volume (*Adjusting the volume, page 3*).
- Turn off the Wi-Fi radio when it is not in use (*Wi-Fi settings, page 53*).
- Put the device in power saving mode when not in use (*Turning the device on or off, page 1*).
- Keep your device away from extreme temperatures.
- Do not leave your device in direct sunlight.

My device is not contacting my emergency contact

WARNING

The device allows you to send your location to an emergency contact. This is a supplementary feature and should not be relied upon as a primary method to obtain emergency assistance. The Garmin Drive app does not contact emergency services on your behalf.

If your device is not contacting your emergency contact, you can try these options.

- Verify that the zūmo navigator is connected to a compatible external power source, such as the included mount or using a USB cable.
- Verify that the zūmo navigator is connected to the Garmin Drive app on your smartphone using Bluetooth wireless technology ([Pairing Your Phone and Headset, page 34](#)).
- Verify that your smartphone is in an area of network coverage where data connectivity is available.
- Verify that the **Automatic Incident Detection** feature and the **Incident Notification** feature are enabled on your zūmo navigator ([Driver Assistance Settings, page 54](#)).
- Verify that you have set up an emergency contact with your device ([Setting Up an Incident Contact, page 11](#)).
- Verify that the incident contact's phone is capable of receiving text messages or email.

My device does not connect to my phone

- Select **Settings > Wireless Networks**.
The Bluetooth option must be enabled.
- Enable Bluetooth wireless technology on your phone and bring your phone within 10 m (33 ft.) of the device.
- Verify your phone is compatible.
Go to www.garmin.com/bluetooth for more information.
- Complete the pairing process again.
To repeat the pairing process, you must unpair your phone and device ([Disconnecting a Bluetooth device, page 37](#)) and complete the pairing process ([Pairing Your Phone and Headset, page 34](#)).

My device does not appear as a removable drive on my computer

On most computers, the device connects using Media Transfer Protocol (MTP). In MTP mode, the device appears as a portable device and not as a removable drive.

My device does not appear as a portable device on my computer

On Mac® computers and some Windows® computers, the device connects using USB mass storage mode. In USB mass storage mode, the device appears as a removable drive or volume, and not as a portable device. Windows versions prior to Windows XP Service Pack 3 use USB mass storage mode.

My device does not appear as either a portable device or a removable drive or volume on my computer

- 1 Disconnect the USB cable from your computer.
- 2 Turn off the device.
- 3 Connect the USB cable to your device and to a USB port on your computer.

TIP: the USB cable must connect to a USB port on your computer, not to a USB hub.

The device turns on automatically and goes into MTP mode or USB mass storage mode. A picture of the device connected to a computer appears on the device screen.

NOTE: if you have several network drives mapped on your computer, Windows may have trouble assigning drive letters to your Garmin drives. For information about assigning drive letters, see the help file for your operating system.

Appendix

Garmin PowerSwitch

⚠ WARNING

Garmin strongly recommends having an experienced installer with the proper knowledge of electrical systems install the device. Incorrectly wiring the power cable can result in damage to the vehicle or the battery and can cause bodily injury.

You can use a connected Garmin PowerSwitch device to control lights, fans and more from your zūmo device.

Mounting Considerations

- The device must be mounted close to the battery and within the range of the supplied power cable.
- The mounting surface must be strong enough to support the weight of the device.
- The location must allow room for the routing and connection of all cables.

Mounting the Device

Before you can mount the device, you must select a mounting location and purchase the appropriate hardware for your mounting surface.

NOTICE

Avoid wires, gauges, air bags, air bag covers, heating, ventilation, and air conditioning and other items when drilling pilot holes and attaching the mount to the vehicle. Garmin is not responsible for any damages or consequences arising from the installation.

- 1 Place the mount on the selected location.



- 2 Using the mount as a template, mark the two screw locations ①.
- 3 Drill pilot holes (optional).
For some types of mounting material, drilling pilot holes is necessary. Do not drill through the mount.
- 4 Securely fasten the mount to the surface using the appropriate hardware for your mounting surface.

Opening the Front Cover

You must open the front cover to make electrical connections.

- 1 Lift the front cover latch ① and rotate it anticlockwise.



- 2 Pull the front cover off of the device.



Connecting Accessories

NOTICE

Do not use the device to control or power a winch. Failure to follow this notice could cause damage to your vehicle or your device.

Do not connect a power source to an accessory output terminal. Failure to follow this notice could cause damage to your vehicle or your device.

Accessory requirements:

- Verify the amperage rating of each accessory before wiring it to the Garmin PowerSwitch device. The device supports accessories up to 30 A for each channel and a maximum of 100 A for the entire system.
 - Use 10 AWG (6 mm²) wires for accessories that use 20 to 30 A.
 - Use 12 AWG (4 mm²) wires for accessories that use 10 to 20 A.
 - Use 14 AWG (2.5 mm²) wires for accessories that use less than 10 A.
 - Use the appropriate size terminals for all accessory connections.
 - Crimp all terminal connectors securely.
- 1 Connect the positive wire from the accessory ① to one of the accessory terminals ② on the Garmin PowerSwitch device.

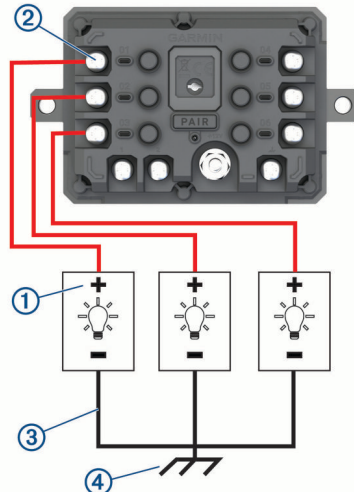

- 2 Connect the negative or ground wire ③ to an unpainted ground stud ④ on the vehicle frame, to a ground distribution block or directly to the negative terminal on the battery.

⚠ CAUTION

Do not connect the accessory ground wires to the ground terminal (GND) on the Garmin PowerSwitch device, as doing so could result in personal injury or property damage, or could negatively impact device functionality.

- 3 Verify that all electrical connections are tight and will not come loose during use.

Connecting a Control Input

You can connect to the control terminals to enable the Garmin PowerSwitch device to turn on customisable outputs. For example, you can connect your vehicle ignition switch to a control input terminal to turn on accessories automatically each time you start your vehicle. The control terminals detect a signal from 3.3 V to 18 V. You can configure output functions with the Garmin PowerSwitch app.

Connect the control wire from the control source in your vehicle to one of the two control terminals on the Garmin PowerSwitch device.

Connecting the Device to Vehicle Power

Before you can connect the device to vehicle power, you must remove the warning tag from the +12V terminal on the device.

You should always confirm all electrical connections are secure and will not come loose while operating the device.

- 1 Connect the large ring end of the included ground wire ① to the negative terminal on the vehicle battery.

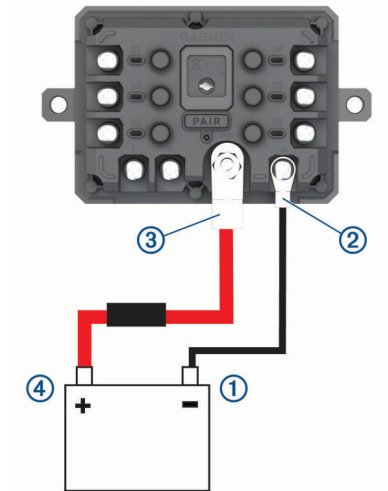

- 2 Connect the small ring end of the ground wire to the **GND** terminal ② on the device.
- 3 Connect the small ring end of the included 12-V cable to the **+12V** terminal ③ on the device.
- 4 Tighten the $\frac{3}{8}$ in. nut on the +12V terminal to a maximum torque specification of 4.52 N-m (40 lbf-in.). You should confirm the nut cannot be loosened by hand.

NOTICE

Do not overtighten the +12V terminal to prevent damage to the terminal.

- 5 Connect the large ring end of the 12-V cable ④ to the positive terminal on the vehicle battery.

Pairing with a Garmin Navigation Device

You can pair your Garmin PowerSwitch device with a compatible Garmin navigation device.

- 1 Turn on power to your Garmin PowerSwitch device and place your compatible Garmin navigation device within 1 m (3.3 ft.) of it.
- 2 On your compatible navigation device, open the Garmin PowerSwitch app.
- 3 Follow the on-screen instructions to complete the pairing and setup process.

The main app dashboard appears. After the devices are paired, they connect automatically when they are turned on and within range.

Garmin PowerSwitch Specifications

Dimensions (D x W x H)	75 x 125 x 32 mm (2.95 x 4.92 x 1.26 in.)
Operating temperature range	From -25° to 85°C (from -13° to 185°F)
Wireless frequency	2.4 GHz @ 10 dBm
Power input	From 12 to 16 V using the included vehicle power cable.
Maximum accessory output	30 A
Maximum system output	100 A
Current draw with all outputs off	3 mA
Water rating	IEC 60529 IPX7 ²

My Garmin PowerSwitch will not stay connected

- Verify the Garmin PowerSwitch device is receiving power.
- Verify that Bluetooth technology is enabled on your paired navigation device or smartphone.
- Move the navigation device or smartphone closer to your Garmin PowerSwitch device.
- Verify that your vehicle's battery is supplying at least 12 V of power.

The Garmin PowerSwitch device turns off all outputs automatically to preserve your vehicle's battery if it is receiving less than 11 V of power (*My accessories are not receiving power, page 66*).

My accessories are not receiving power

- Verify that the Garmin PowerSwitch device is receiving power from the vehicle battery.
- Verify that your vehicle's battery is supplying at least 12 V of power.

The Garmin PowerSwitch device turns off all outputs automatically to preserve your vehicle's battery if it is receiving less than 11 V of power. Outputs turn back on when the device detects more than 12 V of power.

- Verify that all electrical connections are secure and will not come loose while operating the vehicle.
- Verify that each connected accessory draws less than 30 A.

If an accessory draws more than 30 A, the device turns off that output automatically.

- Verify that the total system load is less than 100 A.

If the device detects a system load of more than 100 A, it turns off all outputs automatically.

- Inspect all electrical connections for an electrical short circuit.

Wireless Cameras

Your device can display the video feed from one or more connected wireless cameras (sold separately).

²*The device withstands incidental exposure to water of up to 1 m for up to 30 min. For more information, go to www.garmin.com/waterrating.

Pairing the Camera with a Garmin Navigation Device

You can pair the camera with a compatible Garmin navigation device. For more information about compatible Garmin devices, go to the product page at garmin.com/bc40.

- 1 Update your navigation device to the latest software.
Your device may not support the BC 40 camera without the latest software. For more information about updating the software, see the owner's manual for your navigation device.
- 2 Install batteries in the camera.
The camera enters pairing mode automatically and the LED flashes blue while the camera is in pairing mode. The camera remains in pairing mode for two minutes. If pairing mode expires, you can remove and reinstall the batteries.
- 3 Bring the compatible Garmin navigation device outside your vehicle and within 1.5 m (5 ft.) of the camera and turn on the navigation device.
The device detects your camera automatically and prompts you to pair with it.
- 4 Select **Yes**.
TIP: if the navigation device does not detect the camera automatically, you can select **Settings > Wireless Cameras > Add New Camera** to pair with it manually.
The device pairs with your camera.
- 5 Enter a name for the camera (optional).
You should use a descriptive name that clearly identifies the location of the camera.
- 6 Select **Done**.

Viewing the Wireless Camera

WARNING

This device is intended to enhance situational awareness when used properly. If used improperly, you could become distracted by the display, which could lead to an accident causing serious personal injury or death. Always view the display at a glance when the vehicle is in motion to avoid becoming distracted.

From the home screen or the map, select .

Aligning the Guidance Lines

For the best reference, the guidance lines should be aligned to reflect the outside edges of the vehicle. You should align the guidance lines separately for each backup camera. When you change the camera angle, you should immediately align the guidance lines again.

- 1 Position your vehicle with the driver's side closely aligned to a kerb, driveway or parking stall lines.
TIP: it can be helpful to position the vehicle in the centre of a parking stall and then pull forward into the next stall. This allows you to use the parking stall lines at the rear of the vehicle as reference points for alignment.
- 2 From the paired Garmin navigation device, select **Settings > Wireless Cameras**.
- 3 Select the paired camera name and select **Guidance Lines > Adjust Guidance Lines**.

- 4 Use the arrows in the corners of the screen to move the ends of the white, driver's-side guidance line. The guidance line should appear directly on top of the kerb, driveway or parking stall line.

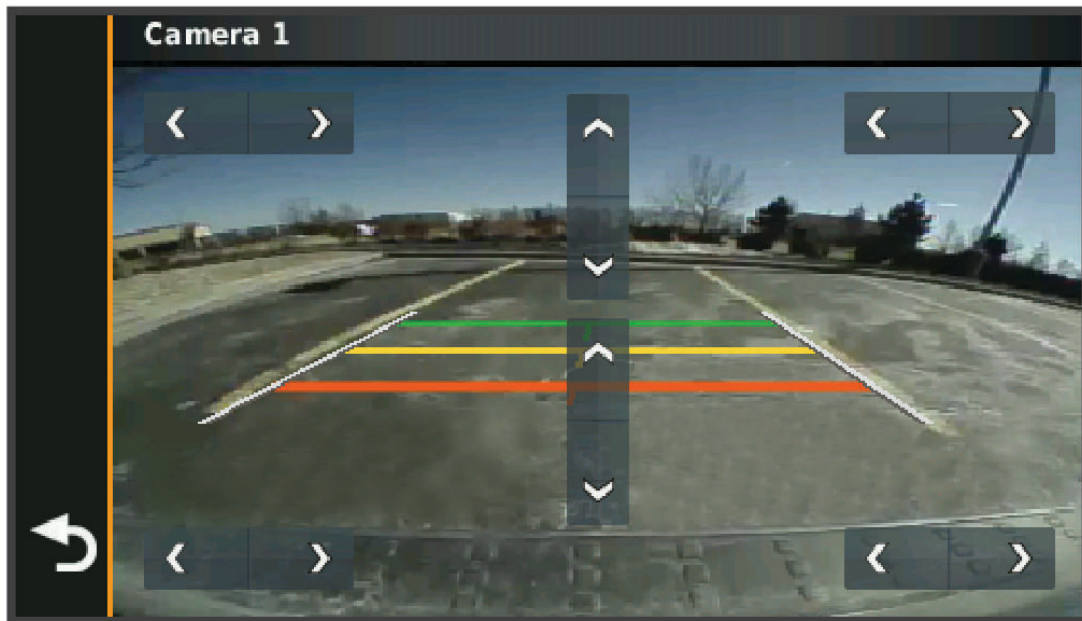

- 5 Use the arrows in the centre of the screen to move the coloured distance guidance lines up or down. The red guidance line should be aligned with the rearmost part of your vehicle. This could be the rear bumper, a trailer hitch or another object protruding from the rear of the vehicle.
- 6 Reposition the vehicle with the passenger side closely aligned to a kerb, driveway or parking stall lines and use the arrows to align the white, passenger-side guidance line. The guidance lines should be symmetrical.

Installing a memory card for maps and data

You can install a memory card to increase the storage space for maps and other data on your device. You can purchase memory cards from an electronics supplier, or go to www.garmin.com/maps to purchase a memory card with pre-loaded Garmin mapping software. The device supports microSD memory cards from 4 to 256 GB.

- 1 Locate the map and data memory card slot on your device (*Device Overview*, page 1).
- 2 Pull up the weather cap from the microSD card slot.
- 3 Slide the microSD card slot cover towards the edge of the device.

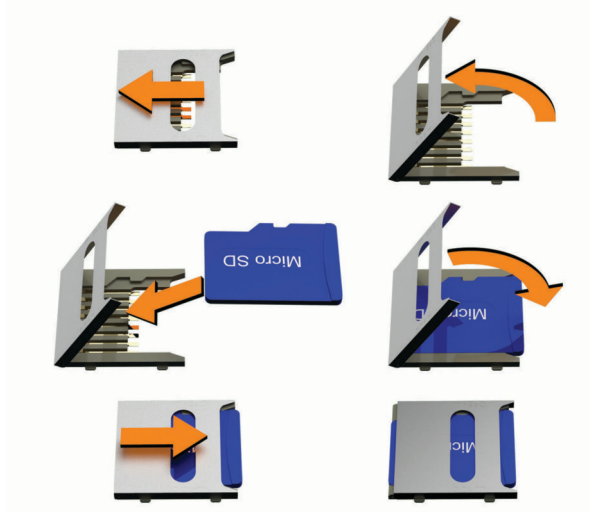

- 4 Pull the microSD card slot cover up.
- 5 Insert a microSD card into the slot.
NOTE: confirm that the microSD card fits flush against the card slot contacts.
- 6 Close the SD card cover.
- 7 Slide the SD card cover towards the centre of the device.

Data management

The device has a memory card slot for additional data storage.

NOTE: the device is compatible with Windows 7 and newer, and Mac OS 10.7 and newer.

About memory cards

You can purchase memory cards from an electronics supplier, or purchase pre-loaded Garmin mapping software (www.garmin.com). Memory cards can be used to store files such as maps and custom POIs.

Connecting the Device to Your Computer

You can connect the device to your computer using a USB cable.

- 1 Plug the small end of the USB cable into the port on the device.
- 2 Plug the larger end of the USB cable into a port on your computer.
- 3 When your zūmo device prompts you to enter file transfer mode, select **Yes**.

A picture of your device connected to a computer appears on the device screen.

Depending on your computer operating system, the device appears as either a portable device, a removable drive, or a removable volume.

Transferring GPX Files From Your Computer

Apple computers may require additional third-party software, such as Android File Transfer, to read and write files on this device.

If you have already created routes that you want to use on your device, you can transfer GPX files directly from your computer.

- 1 Connect the device to your computer ([Connecting the Device to Your Computer, page 69](#)).
The device appears as a portable device.
- 2 On your computer, open the file browser.
- 3 Select a GPX file.
- 4 Select **Edit > Copy**.
- 5 Browse to the GPX folder on the device.
- 6 Select **Edit > Paste**.

Transferring data from your computer

- 1 Connect the device to your computer ([Connecting the Device to Your Computer, page 69](#)).
Depending on your computer operating system, the device appears as either a portable device, a removable drive, or a removable volume.
- 2 On your computer, open the file browser.
- 3 Select a file.
- 4 Select **Edit > Copy**.
- 5 Browse to a folder on the device.
NOTE: for a removable drive or volume, you should not place files in the Garmin folder.
- 6 Select **Edit > Paste**.

Disconnecting the USB cable

If your device is connected to your computer as a removable drive or volume, you must safely disconnect your device from your computer to avoid data loss. If your device is connected to your Windows computer as a portable device, it is not necessary to safely disconnect the device.

- 1 Complete an action:
 - For Windows computers, select the **Safely Remove Hardware** icon in the system tray and select your device.
 - For Apple computers, select the device, and select **File > Eject**.
- 2 Disconnect the cable from your computer.

Adding BaseCamp™ Data to Garmin Explore

You can export your BaseCamp data files and import them to Garmin Explore for use with your zūmo device.

- 1 Export your data from BaseCamp:
 - If you are using an Apple computer, see [Exporting Data from BaseCamp with an Apple Computer, page 71](#).
 - If you are using a PC, see [Exporting Data from BaseCamp with a PC, page 71](#).
- 2 Import your BaseCamp data to the Garmin Explore website ([Importing Data to Garmin Explore, page 71](#)).
- 3 Synchronise your Garmin Explore data with your zūmo device ([Synchronising Garmin Explore Account Data, page 23](#)).

Exporting Data from BaseCamp with a PC

- 1 Select an option:
 - To export all BaseCamp data stored on your computer, select **My Collection** and select **File > Export > Export 'My Collection'**.
 - To export one or more items or a list, select one or more items or a list and select **File > Export > Export Selection**.
- 2 Enter a name, select a location for the exported file, select the file format and select **Save**.

Exporting Data from BaseCamp with an Apple Computer

- 1 Select an option:
 - To export all BaseCamp data stored on your computer, select **My Collection** and select **File > Export 'My Collection'**.
 - To export one or more items or a list, select one or more items or a list and select **File > Export Selected User Data**.
- 2 Enter a name.
- 3 Select a location for the exported file.
- 4 Select the file format.
- 5 Select **Export**.

Importing Data to Garmin Explore

- 1 Go to explore.garmin.com and log in to your account.
- 2 Select the **Map** tab.
- 3 Select .
- 4 Follow the on-screen instructions.

Viewing GPS signal status

Hold  for three seconds.

Purchasing additional maps

- 1 Go to your device product page at garmin.com.
- 2 Click on the **Map** tab.
- 3 Follow the on-screen instructions.

