

vtech[®]

Instruction Manual

My Busy Workbench

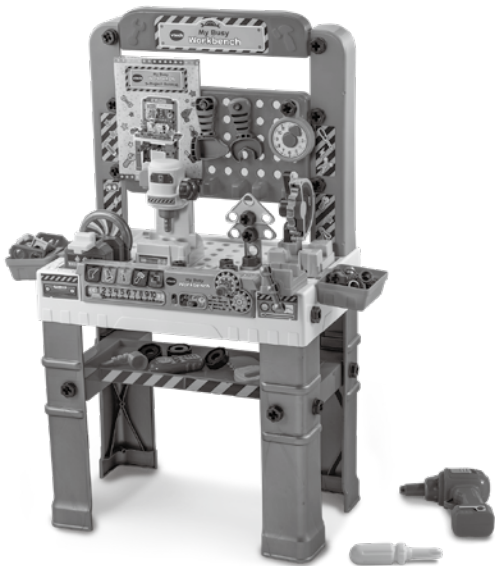

VTech understands that a child's needs and abilities change as they grow and with that in mind we develop our toys to teach and entertain at just the right level...

vtech Baby

Toys that will stimulate their interest in different textures, sounds and colours

I am...

...responding to colours, sounds and textures

...understanding cause and effect

...learning to touch, reach, grasp, sit-up, crawl and toddle

Birth-36 months



Pre-School

Interactive toys to develop their imagination and encourage language development

I want...

...to get ready for school by starting to learn the alphabet and counting

...my learning to be as fun, easy and exciting as can be

...to show my creativity with drawing and music so my whole brain develops

3-6 years



Electronic Learning Computers

Cool, aspirational and inspiring computers for curriculum related learning

I need...

...challenging activities that can keep pace with my growing mind

...intelligent technology that adapts to my level of learning

...National Curriculum based content to support what I'm learning at school

4-10 years



To learn more about this and other VTech® products, visit www.vtech.co.uk

INTRODUCTION

Thank you for purchasing the **My Busy Workbench**.

Let's build! Get ready for role-play fun with the included workbench, working toy drill, hammer, spanner, sander, saw and screws. Let's get to work!

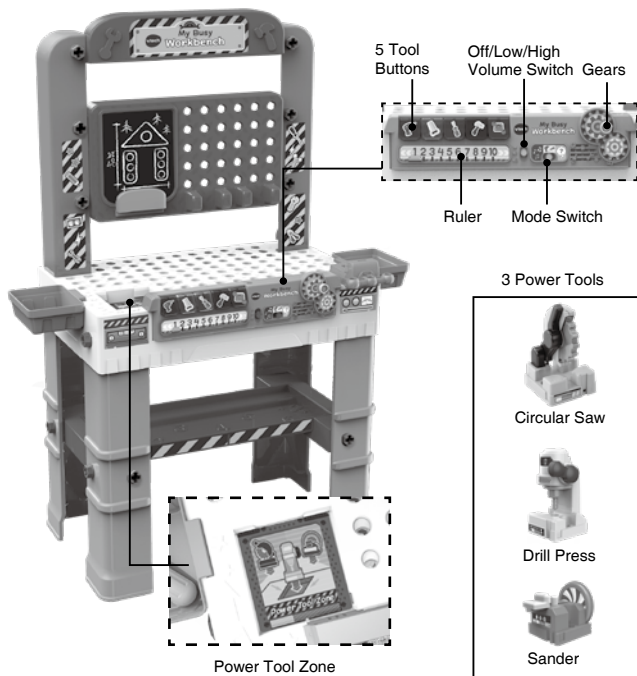

INCLUDED IN THE PACKAGE

- 1 Workbench top

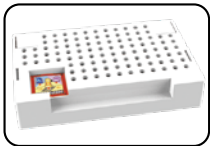

- 1 Electronic panel



- 1 Back panel

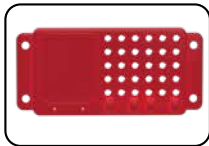

- 1 Back panel top



- 2 Panel supports

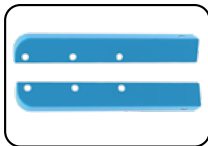

- 4 Legs



- 2 Trays



- 1 Left leg support

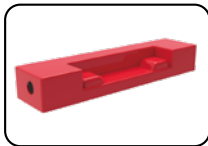

- 1 Right leg support

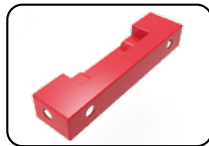

- 1 Centre tray



- 1 Circular saw top

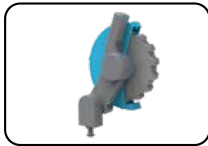

- 1 Circular saw base



- 1 Sander base

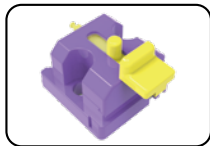

- 1 Sander top



- 1 Drill press top

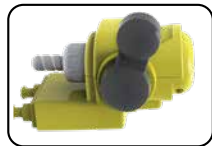

- 1 Drill press base

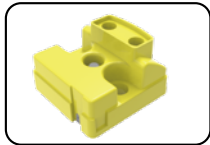

- 1 Project Guide holder



- 1 Clock



- 1 Drill



- 1 Spanner



- 1 Hammer



- 1 Walkie-Talkie



- 1 Saw



- 1 L-Shaped Spanner



- 1 Vice



- 1 Screwdriver



- 1 Large gear

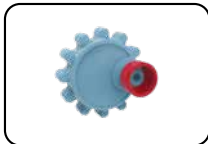

- 17 Building pieces

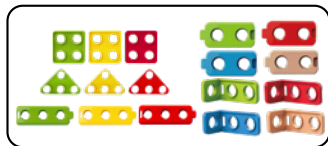

- 4 Toy pegs & 4 Toy Wheels

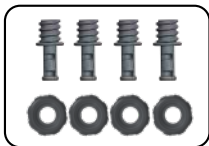

- 10 Blue toy screws & nuts



- 5 Toy bolts



For Workbench Assembly

- 19 Grey toy screws & nuts

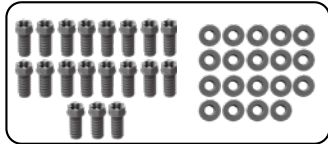

- 10 Real screws



Note:

The grey toy screws and toy nuts are for assembly.
The blue toy screws and toy nuts are play pieces.

- 1 Label sheet



- Project Guide
- Quick Start Guide

WARNING

All packing materials such as tape, plastic sheets, packaging locks, removable tags, cable ties, cords and packaging screws are not part of this toy and should be discarded for your child's safety.

NOTE

Please save this Instruction Manual as it contains important information.

Unlock the Packaging Locks

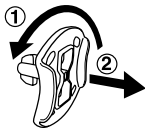

- ① Rotate the packaging locks anticlockwise 90 degrees.
- ② Pull out the packaging locks and discard.

CAUTION:

Adult assembly required. This package contains small parts. For your child's safety, do not let your child play with the toy until it is fully assembled.

CAUTION:

For your child's safety, do not let your child stand or sit on the table of the Workbench.

BATTERY INSTRUCTIONS

Battery Removal and Installation

1. Make sure the unit is turned **Off**.
2. Find the battery cover located on the back of the electronic panel, use a screwdriver to loosen the screws, and then open the battery cover.
3. Remove old batteries by pulling up on one end of each battery.
4. Install 2 new AA (AM-3/LR6) batteries following the diagram inside the battery box. (For best performance, alkaline batteries or fully charged Ni-MH rechargeable batteries are recommended).
5. Replace the battery cover and tighten the screws to secure.

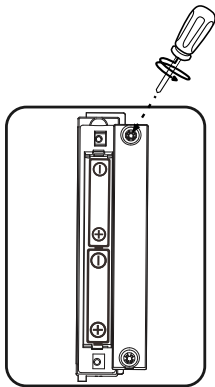

IMPORTANT: BATTERY INFORMATION

- Insert batteries with the correct polarity (+ and -).
- Do not mix old and new batteries.
- Do not mix alkaline, standard (carbon-zinc) or rechargeable batteries.
- Only batteries of the same or equivalent type as recommended are to be used.
- Do not short-circuit the supply terminals.
- Remove batteries during long periods of non-use.
- Remove exhausted batteries from the toy.
- Dispose of batteries safely. Do not dispose of batteries in fire.

RECHARGEABLE BATTERIES:

- Remove rechargeable batteries (if removable) from toy before charging.
- Rechargeable batteries are only to be charged under adult supervision.
- Do not charge non-rechargeable batteries.

Disposal of batteries and product



The crossed-out wheeled bin symbols on products and batteries, or on their respective packaging, indicates they must not be disposed of in domestic waste as they contain substances that can be damaging to the environment and human health.

The chemical symbols Hg, Cd or Pb, where marked, indicate that the battery contains more than the specified value of mercury (Hg), cadmium (Cd) or lead (Pb) set out in the Batteries and Accumulators Regulation.

The solid bar indicates that the product was placed on the market after 13th August, 2005.



Please dispose of your product and batteries responsibly. In the UK, give this toy a second life by disposing of it at a small electricals collection point* so all of its materials can be recycled.

Learn more at:

www.vtech.co.uk/recycle

www.vtech.com.au/sustainability

* Visit www.recyclenow.com to see a list of collection points near you.

LABEL APPLICATION

Please securely stick the labels to the toy as indicated below:



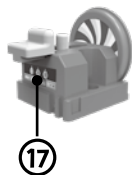
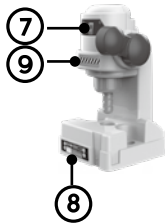
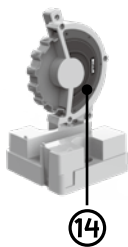
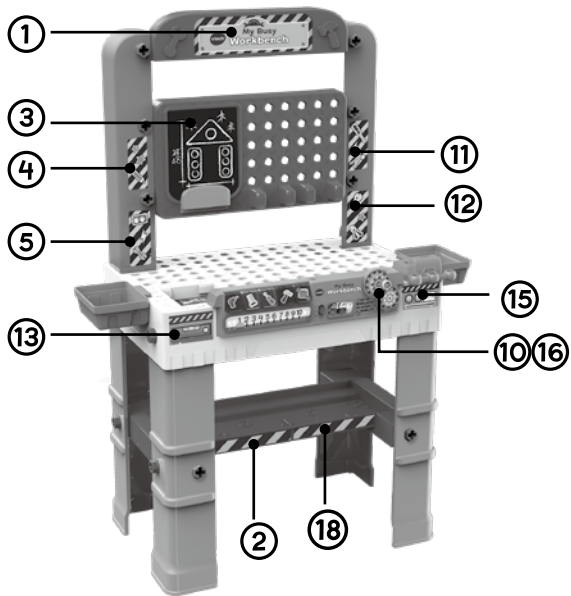

WORKBENCH ASSEMBLY INSTRUCTIONS

Please refer to images on pages 3, 4 and 5.

1. **NOTE:** Use the included **L-Shaped Spanner** to screw a **Grey Toy Nut** to a **Grey Toy Screw** during assembly.

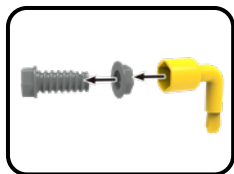

2. Use the included **Drill** or **Screwdriver** to tighten 8 **Grey Toy Screws** and **Nuts** to attach the **Right** and **Left Leg Supports** where the centre tray will rest on the left and right legs.

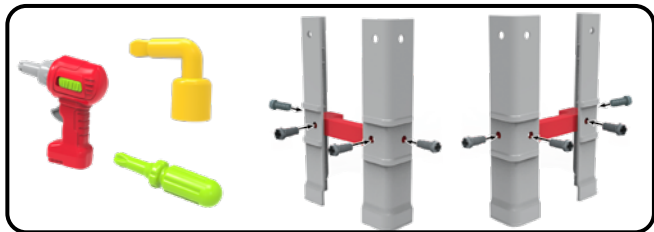

3. Insert the **Centre Tray** into the two **Leg Supports**.

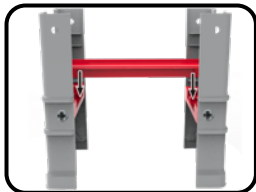

4. Insert the **Large Gear** into the **Electronic Panel**. Insert the **Electronic Panel** into the slot of the **Workbench Top**. Use four of the **Real Screws** and your own screwdriver to securely attach the **Electronic Panel**.

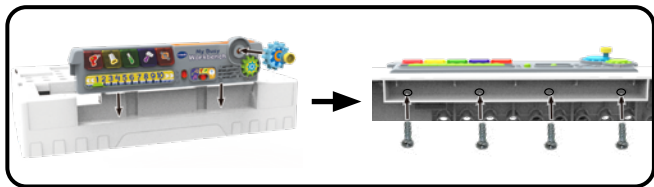

5. Use four of the **Real Screws** and your own screwdriver to securely attach the **Vice**.

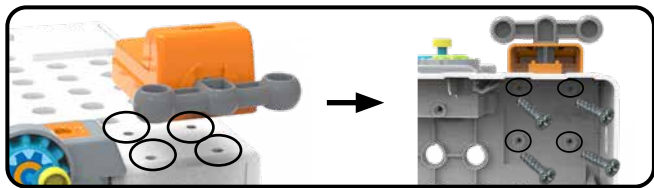

6. To secure the base to the legs, use the included **Drill** or **Screwdriver** to tighten two of the **Grey Toy Screws** to the **Workbench Top**.
NOTE: Do not use 2 extra Grey Toy Screws to secure the back legs. You will do this later on in assembly.



7. Use the remaining two **Real Screws** to attach the **Project Guide Holder** to the **Back Panel** of the **Workbench**.

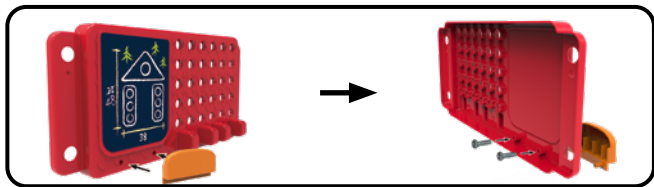

8. Use four of the **Grey Toy Screws** and the included **Drill** or **Screwdriver** to tighten the **Back Panel** of the **Workbench** to the **Panel Supports**.

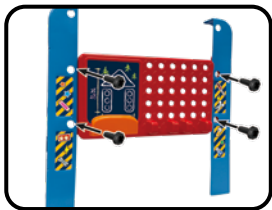

9. Use two of the **Grey Toy Screws** and the included **Drill** or **Screwdriver** to tighten the **Back Panel Top** of the **Workbench** to the **Panel Supports**.



10. Insert the **Panel Supports** into the **Workbench Top** and use two of the **Grey Toy Screws** and the included **Drill** or **Screwdriver** to tighten the supports.

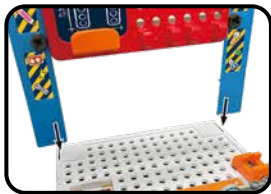

11. Clip the two **Trays** into the slots to the left and right of the **Workbench Top**.



12. Use a **Grey Toy Screw** and the included **Drill** or **Screwdriver** to attach the **Clock** to the **Back Panel** of the **Workbench**.



13. Put a **Toy Peg** into the **Back Panel** of the **Workbench** and hang the **Spanner** or **Hammer** on the **Toy Peg**, or insert the **Spanner** or **Hammer** into a slot on the **Back Panel** of the **Workbench**.



POWER TOOL ASSEMBLY INSTRUCTIONS

Circular Saw, Drill Press and Sander

1. Insert the **Drill Press Top** into the **Drill Press Base**. You will hear the pieces snap into place when properly inserted.

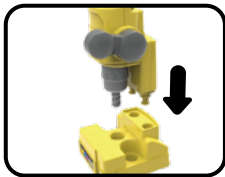

2. Insert the **Circular Saw Top** into the **Circular Saw Base**. You will hear the pieces snap into place when properly inserted.

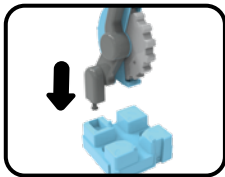

3. Insert the **Sander Top** into the **Sander Base**. You will hear the pieces snap into place when properly inserted.

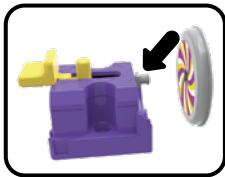

NOTE: The tool tops and bases cannot be disassembled after assembly.

Activating Normal Play Mode

The first time the **My Busy Workbench** is used, you will need to exit Try-Me mode and activate Normal Play mode.

1. Turn the unit **On**.
2. Place a **Power Tool** on the **Power Tool Zone**. You will hear a sound indicating that the unit is in Normal Play mode.

Using the Power Tools

Drill Press

- Place the **Drill Press** in the **Power Tool Zone**.
- Place a rectangular **Building Piece** on the base of the **Drill Press**.
- Press down the **Drill Press** handle to pretend to make straight holes.

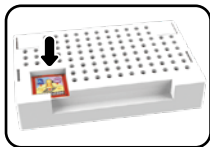

Circular Saw

- Place the **Circular Saw** in the **Power Tool Zone**.
- Connect two rectangular **Building Pieces** together.
- Place the **Building Piece** on the **Circular Saw** base.
- Press down the grey handle of the **Circular Saw** to “cut” the **Building Piece** into two parts.



Sander

- Place the **Sander** in the **Power Tool Zone**.
- Place a rectangular **Building Piece** on the peg of the sander.
- Push the bar forward to pretend to make the block smooth.



TO BEGIN PLAY

Move the **Off/Low/High Volume Switch** to Low or High to turn on the unit, then move the **Mode Switch** to select a game to play.

PRODUCT FEATURES

1. Off/Low/High Volume Switch

To turn the unit **On** or adjust the volume, slide the **Off ●/Low 🗨/High 🗨) Volume Switch** to Low or High volume. To turn the unit **Off**, slide the switch to **Off**.



2. Mode Switch

Slide the **Mode Switch** to choose from three different activities.



3. Power Tools

Place **Circular Saw**, **Drill Press** or **Sander** in the **Power Tool Zone** to learn about colours, tools facts and fun sound effects. Listen to sing-along songs or answer the activity questions.

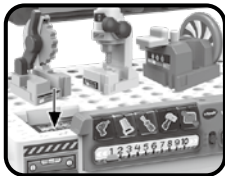

4. Tool Buttons

Press the **Tool Buttons** to learn about colours and tools facts, listen to sing-along songs or to answer the activity questions. The light will flash or light up with the songs and melodies.



5. Ruler

Move the ruler slider to learn about numbers and ruler facts, listen to sing-along songs or answer the activity questions.

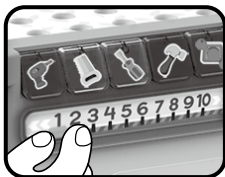

6. Gears

Turn the **Gears** to learn about gear facts, listen to gear sound effects and sing-along songs or repeat question.

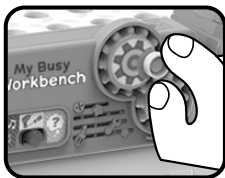

7. Automatic Shut-Off

To preserve battery life, the **My Busy Workbench** will automatically shut off after approximately 1 minute without input. The unit can be turned on again by sliding the **Off/Low/High Volume Switch**.

NOTE

If the unit powers down or if the light fades out during play, please install a new set of batteries.

ACTIVITIES

1. Music Mode

Move the **Mode Switch** to Music Mode  to hear fun songs. Press the buttons, or insert the circular saw, drill press, or sander tools into the Power Tool Zone, or move the ruler slider to listen to sing-along songs about tools and number facts. Turn the Gears to listen to fun music.



2. Free Play Mode

Move the **Mode Switch** to Free Play Mode  to enter this activity. Press the buttons, or insert the circular saw, drill press, or sander tools into the Power Tool Zone, or move the ruler slider to learn about tools, numbers, colours and measuring. Turn the Gears to learn about gear facts and to listen to gears sounds.



3. Quiz Mode

Move the **Mode Switch** to Quiz Mode  to enter this activity. The workbench will ask a series of questions about tools, colours, numbers, or recognisable tools (circular saw, drill press, and sander); press the buttons, or move the ruler slider to answer. Turn the gears to repeat the question.



CARE & MAINTENANCE

1. Keep the unit clean by wiping it with a slightly damp cloth.
2. Keep the unit out of direct sunlight and away from direct heat sources.
3. Remove the batteries if the unit will not be in use for an extended period of time.
4. Do not drop the unit on hard surfaces and do not expose the unit to moisture or water.
5. If the unit stops working or malfunctions, install a new set of batteries.

CONSUMER SERVICES

Creating and developing **VTech®** products is accompanied by a responsibility that we at **VTech®** take very seriously. We make every effort to ensure the accuracy of the information, which forms the value of our products. However, errors sometimes can occur. It is important for you to know that we stand behind our products and encourage you to call our Consumer Services Department with any problems and/or suggestions that you might have. A service representative will be happy to help you.

UK Customers:

Phone: 0330 678 0149 (from UK) or +44 330 678 0149 (outside UK)

Website: www.vtech.co.uk/support

Australian Customers:

Phone: 1800 862 155

Website: support.vtech.com.au

NZ Customers:

Phone: 0800 400 785

Website: support.vtech.com.au

Contact VTech

Tel: 0330 678 0149 (from UK)

+44 330 678 0149 (outside UK)

1800 862 155 (Aus) / 0800 400 785 (NZ)

www.vtech.co.uk

www.vtech.com.au

**Visit our website for more
information about our products,
downloads, resources and more.**

www.vtech.co.uk
www.vtech.com.au



TM & © 2023 VTech Holdings Limited.
All rights reserved.
IM-560000-000
Version: 0