



**SPEED**  
CHAMPIONS

76918





### **Get excited about our new packaging!**

We're switching from plastic to paper-based packaging. That's why you might find a mix of paper and plastic in our boxes!

### **Nos nouveaux emballages vous emballeront !**

Nous passons des emballages en plastique aux emballages à base de papier. C'est pourquoi vous pourriez trouver un mélange de papier et de plastique dans nos boîtes !

### **¡Te presentamos nuestros nuevos empaques!**

Estamos sustituyendo las bolsas de plástico por bolsas con base de papel. ¡Por eso, puedes encontrar una mezcla de papel y de plástico en nuestras cajas!

**[LEGO.com/sustainable-packaging](https://www.lego.com/sustainable-packaging)**



# BUILDER



Apple and the Apple logo are trademarks of Apple Inc., registered in the U.S. and other countries and regions. App Store is a service mark of Apple Inc. Google Play and the Google Play logo are trademarks of Google LLC. Tencent and the Tencent logo are trademarks of Tencent Inc.

**EN** Ask parents' permission before going online | **DE** Eltern um Erlaubnis bitten, bevor du online gehst | **FR** Demande l'autorisation d'un parent avant d'aller en ligne | **IT** Chiedi il permesso ai tuoi genitori prima di andare online | **ES** Pídeles permiso a tus papás antes de conectarte a Internet | **PT** Pede autorização aos pais antes de acederes online | **JA** オンラインになる前に ほかの方のきよかをもらおう | **ZH** 上网前应先征得父母的同意 | **KO** 온라인 접속 전에 보호자 동의가 필요합니다 | **RU** Спроси разрешения у родителей, прежде чем заходить в интернет | **PL** Poproś rodziców o zgodę, zanim wejdziesz do Internetu | **CS** Než půjdeš na internet, požádej rodiče o svolení | **SK** Skôr než pôjdeš na internet, vypýtaj si povolenie od rodičov | **HU** Kérj szülői engedélyt, mielőtt online csatlakoznál! | **RO** Cere permisiunea părinților înainte de a te conecta online | **BG** Поискайте разрешение от родител, преди да влезете онлайн | **LV** Pirms došanās tiešsaistē palūdz atļauju vecākiem | **ET** Enne Interneti kasutamist küsi vanematelt luba | **LT** Prieš prisijungdami prie interneto, atsklauskite tėvų

[LEGO.com/devicecheck](https://www.lego.com/devicecheck)

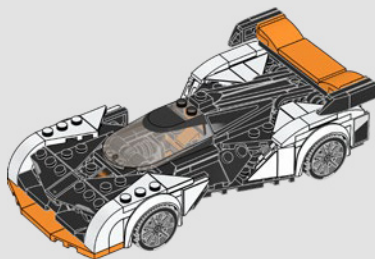
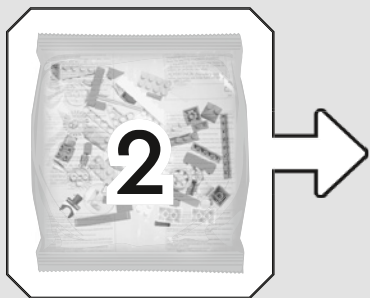
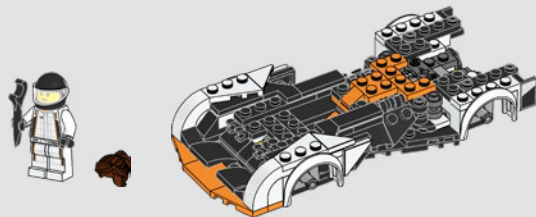
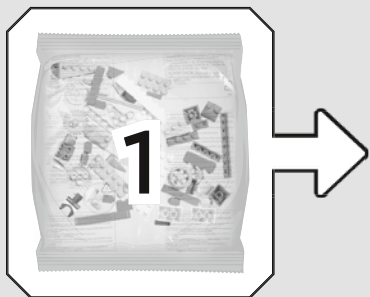



1

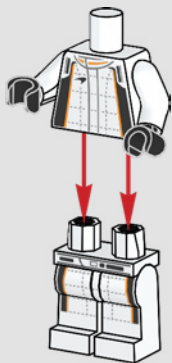

2

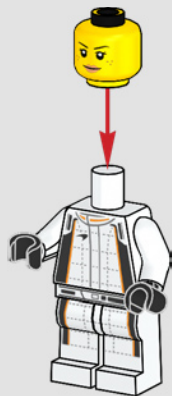

3



4



5

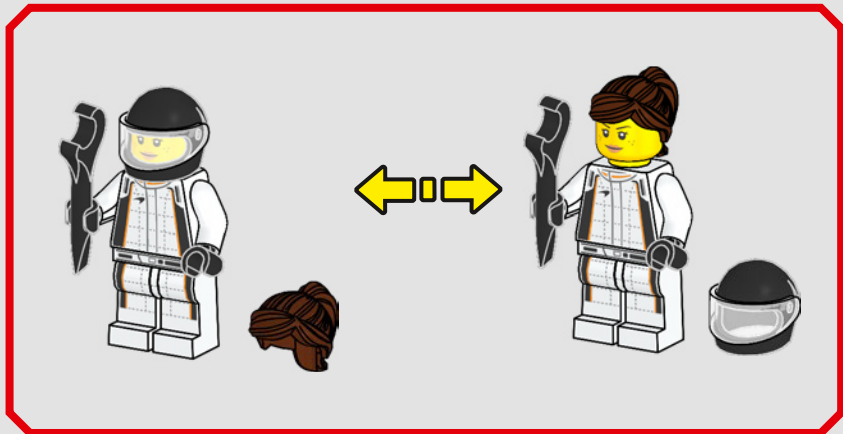
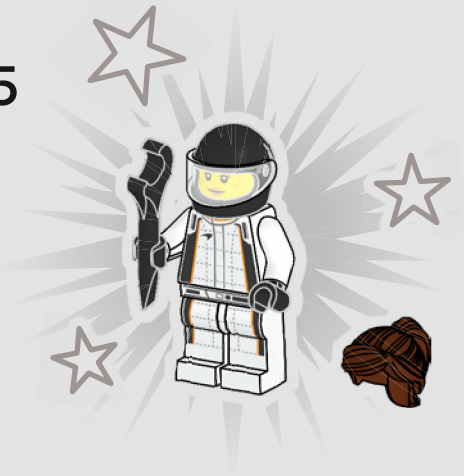

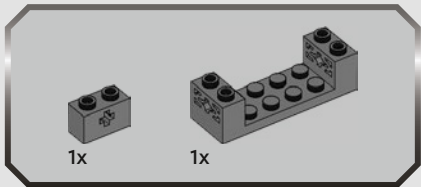
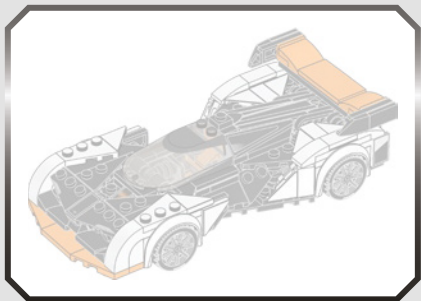

1

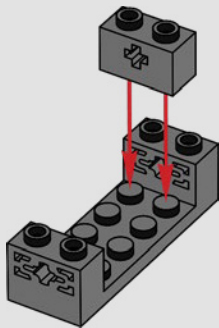

2

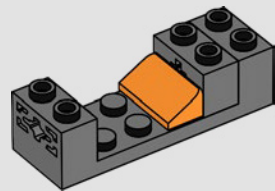



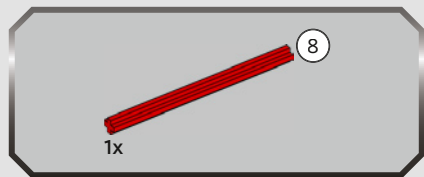

3

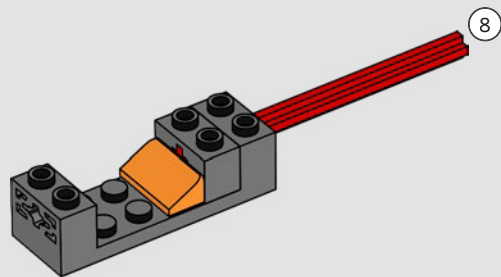

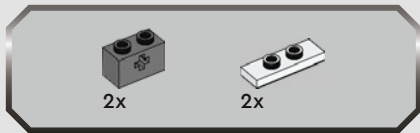

4

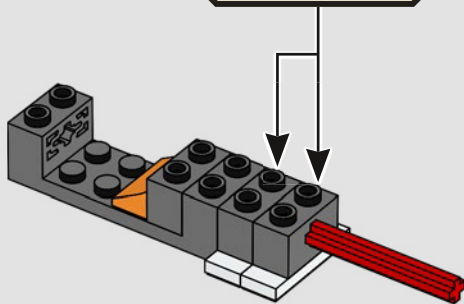
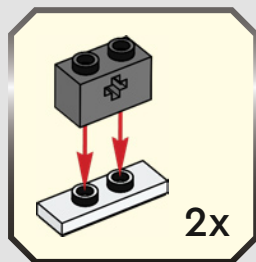



5

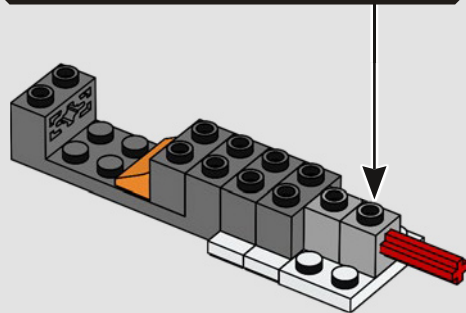
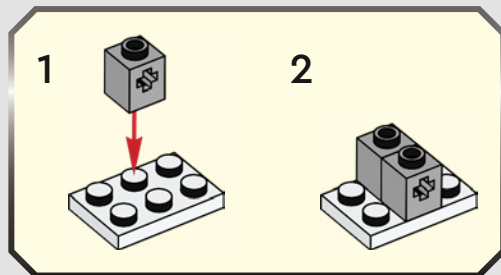

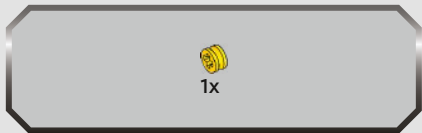

6

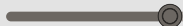
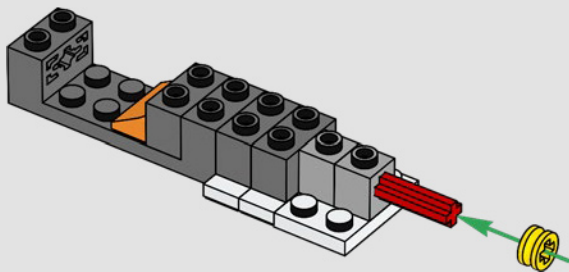

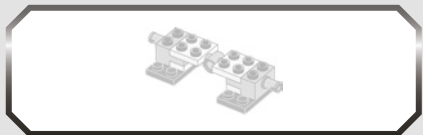

7

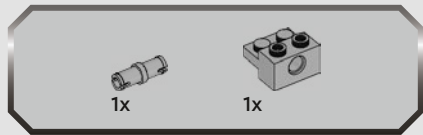
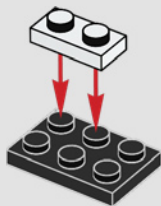

8

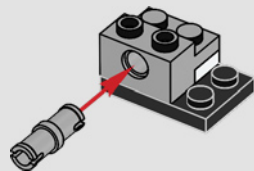



1x

9

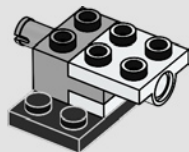

1x

10

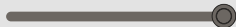
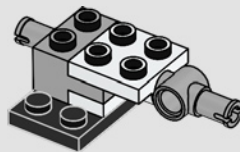

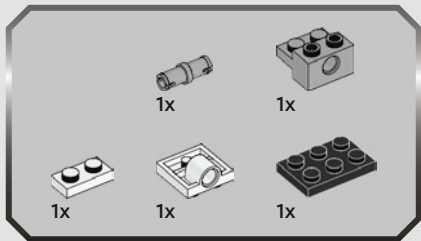

11

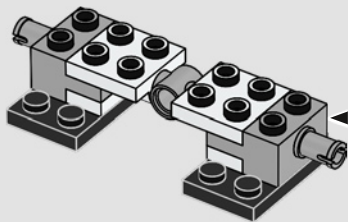
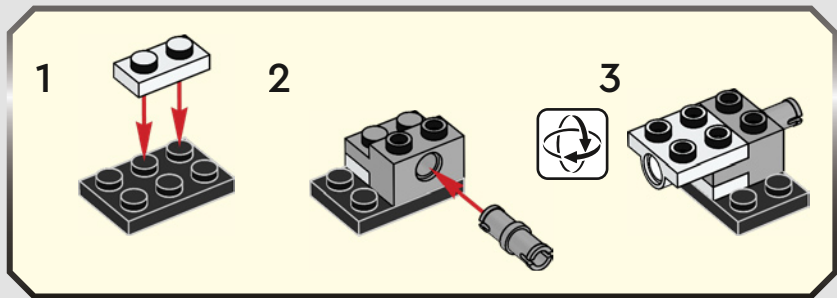

12

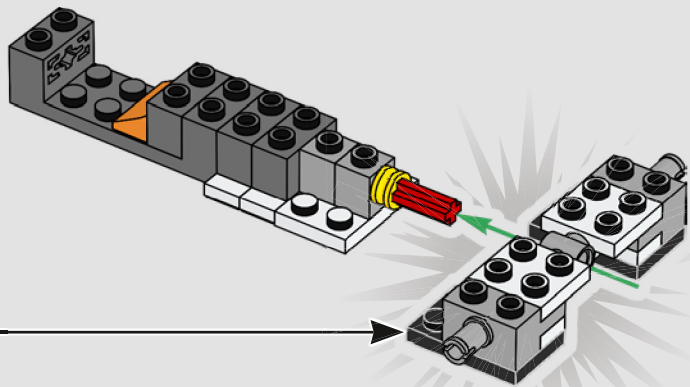

13

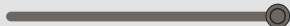
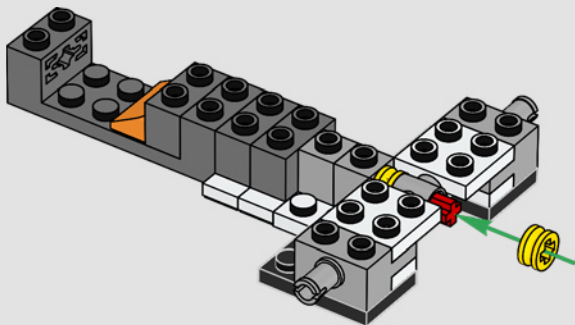



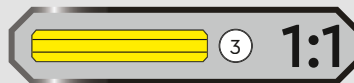
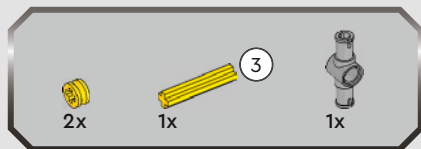

14

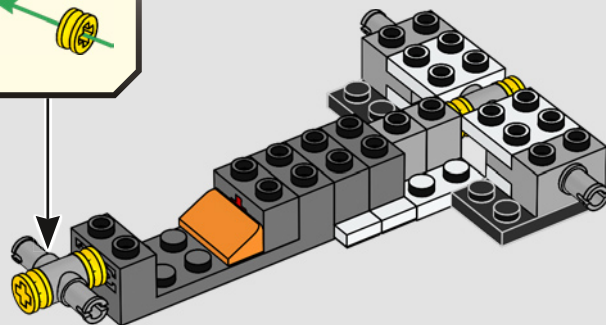
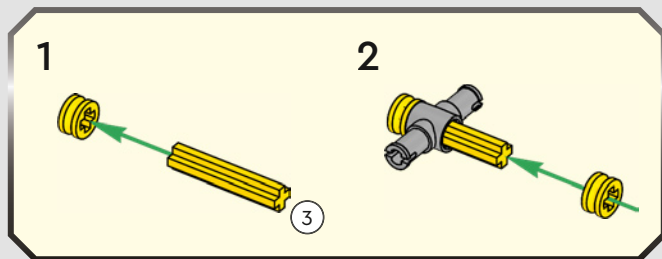

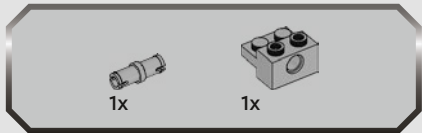
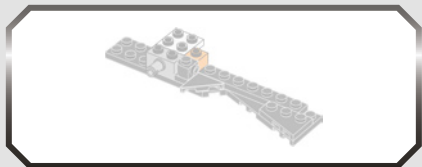

15

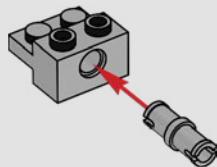

16

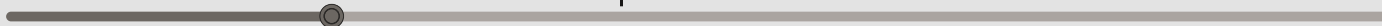
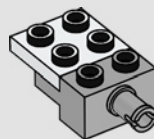

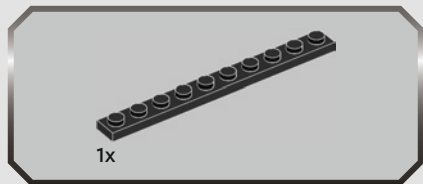

17

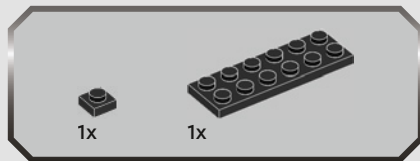
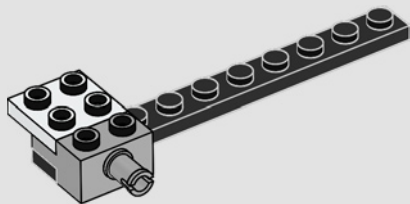

18

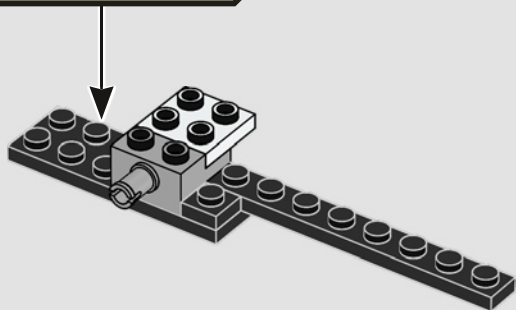
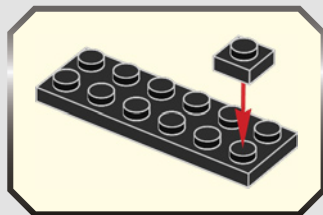

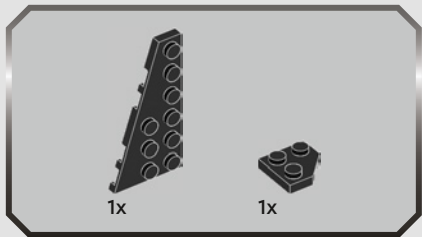

19

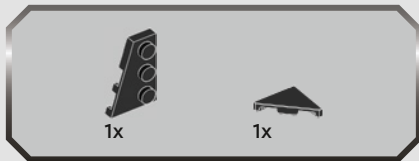
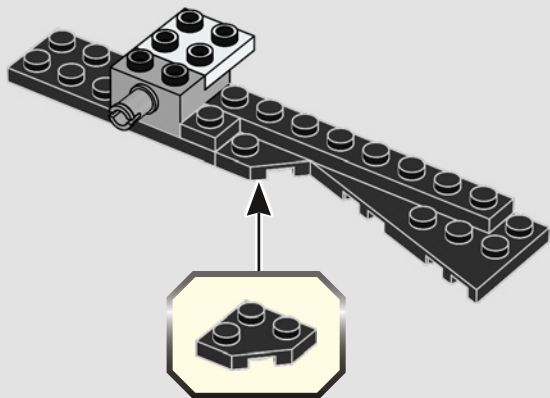

20

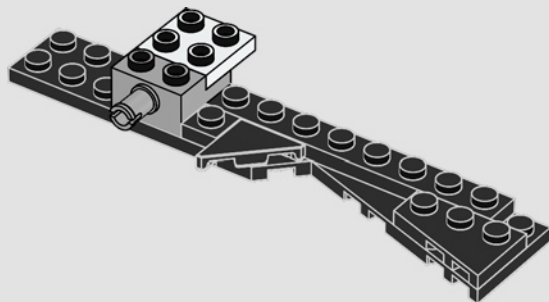



21

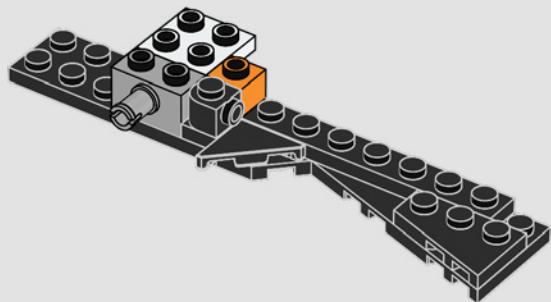

22

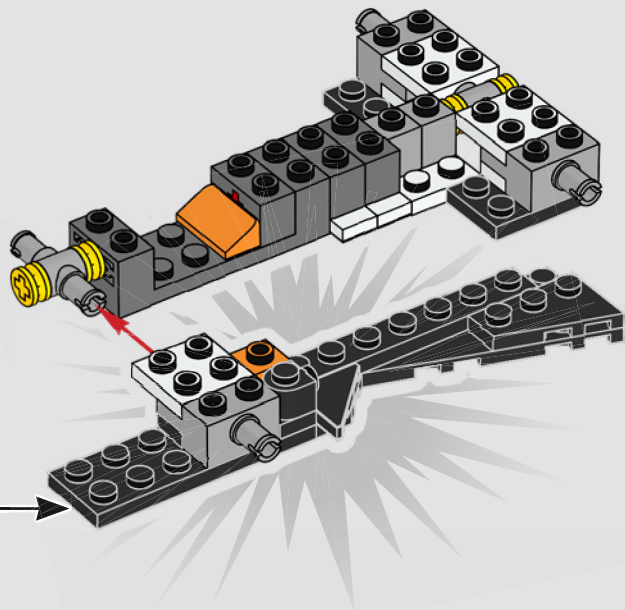

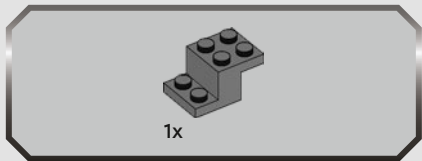

23

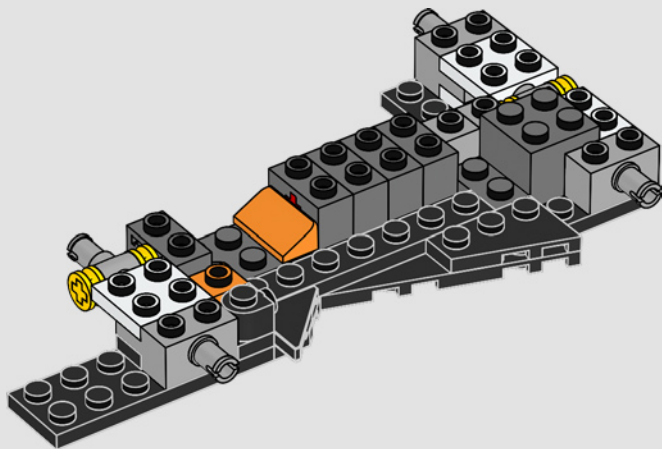

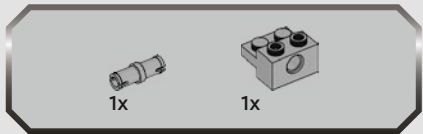
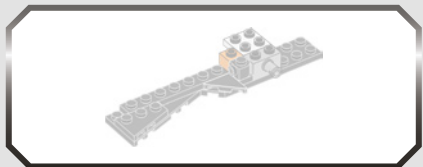

24

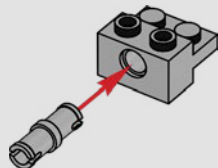

25

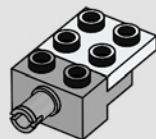

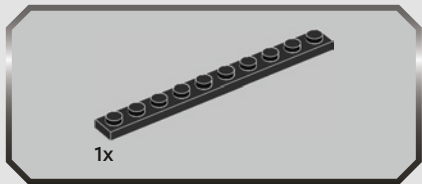

26

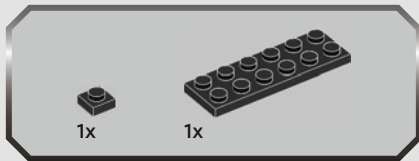
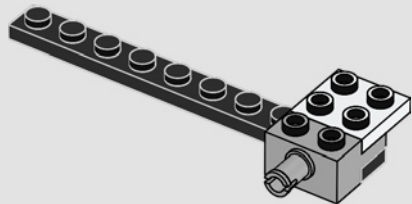

27

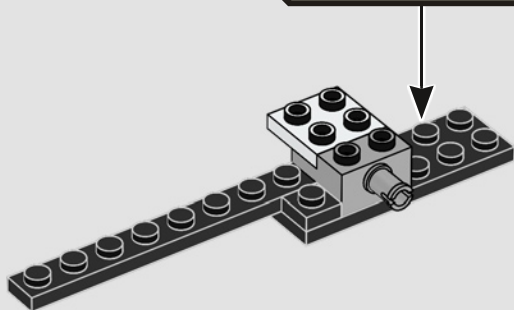
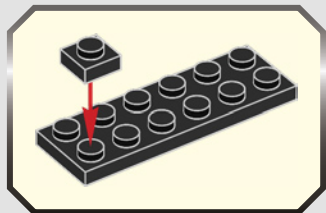



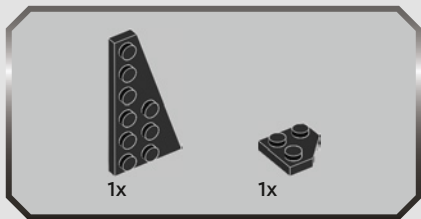

28

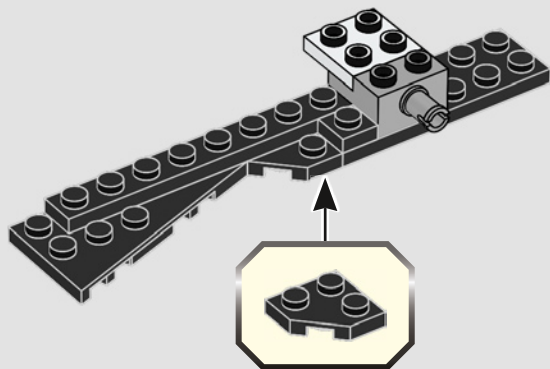

29

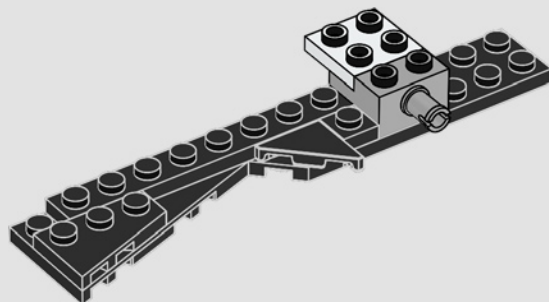



1x



1x

30

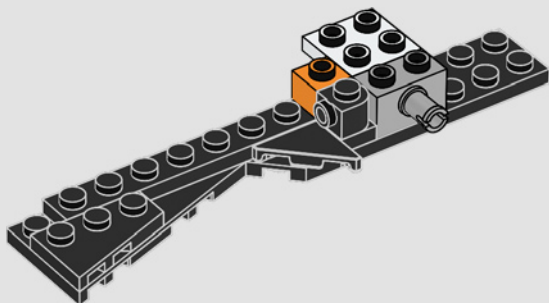

31

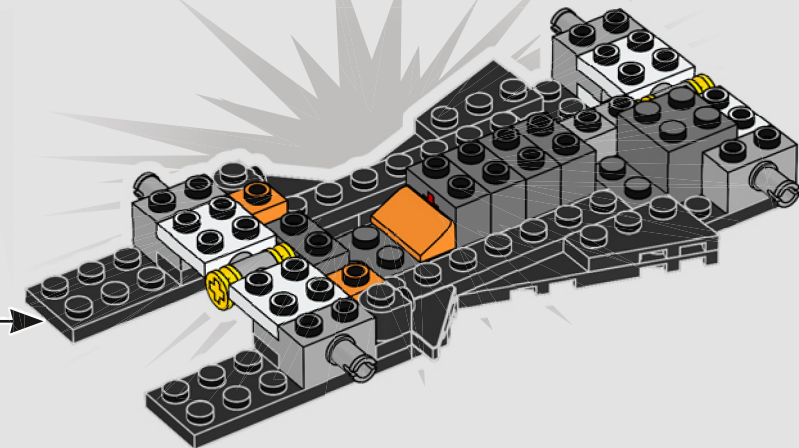

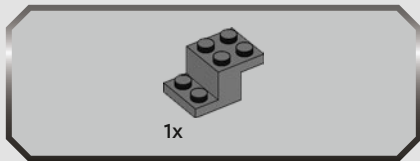

32

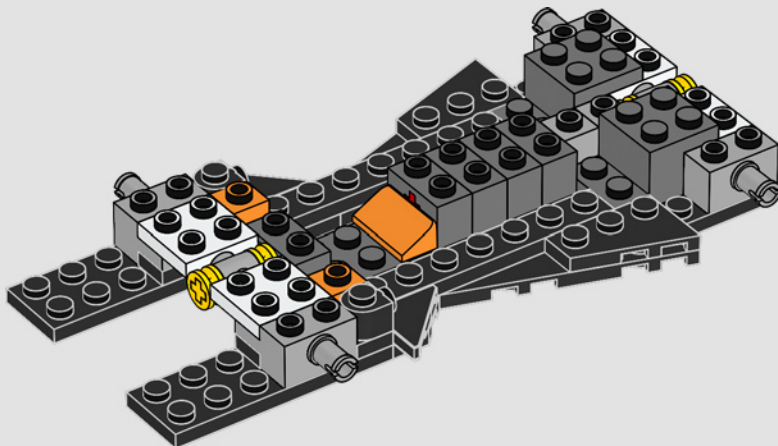

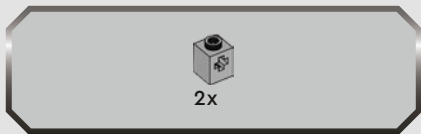

33

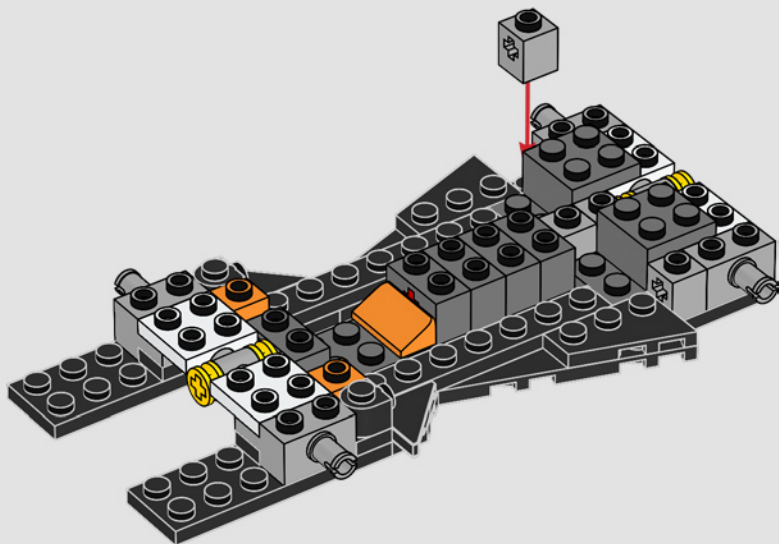



34

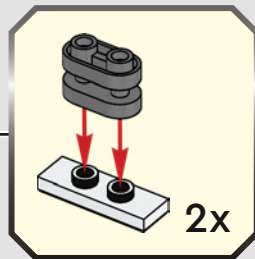
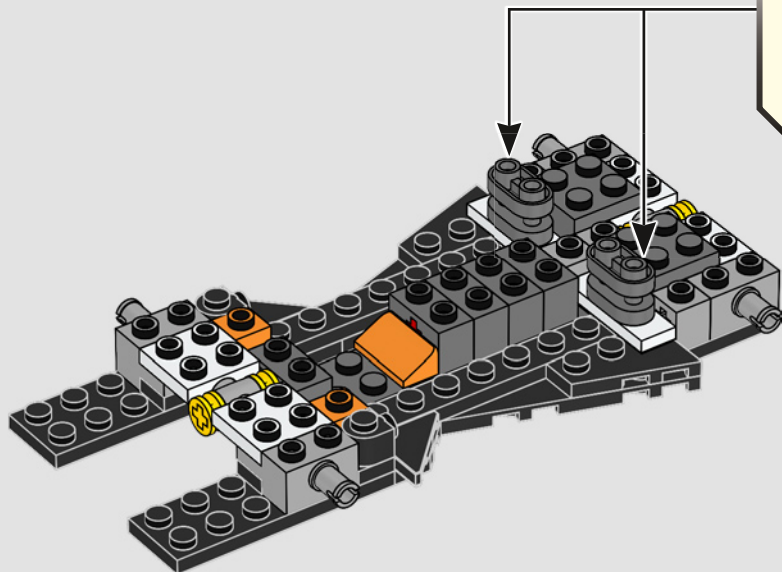

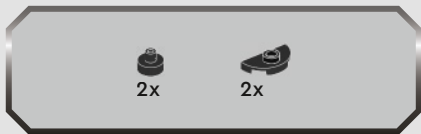

35

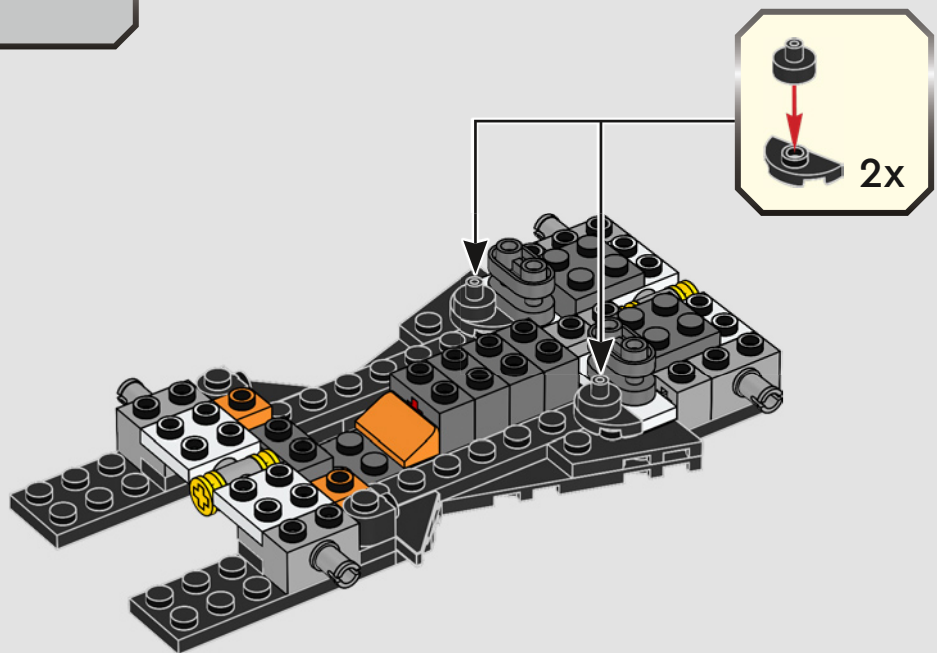



2x

36

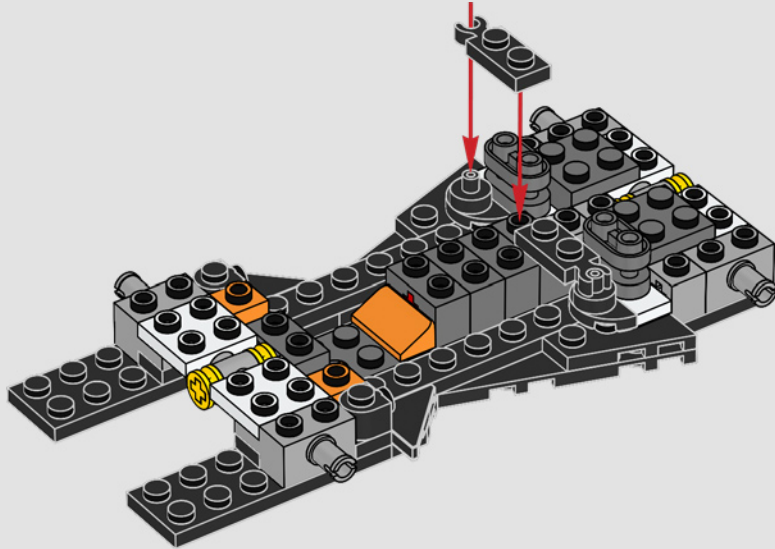



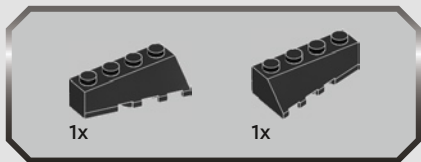

37

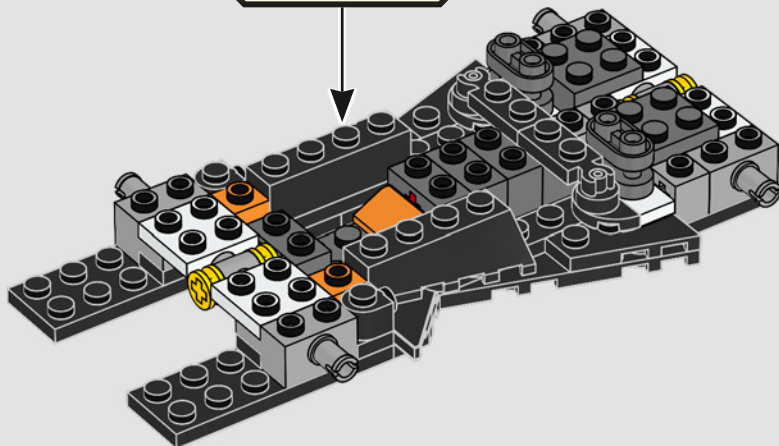
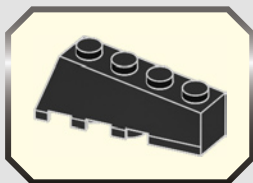

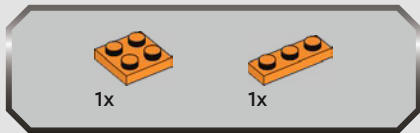

38

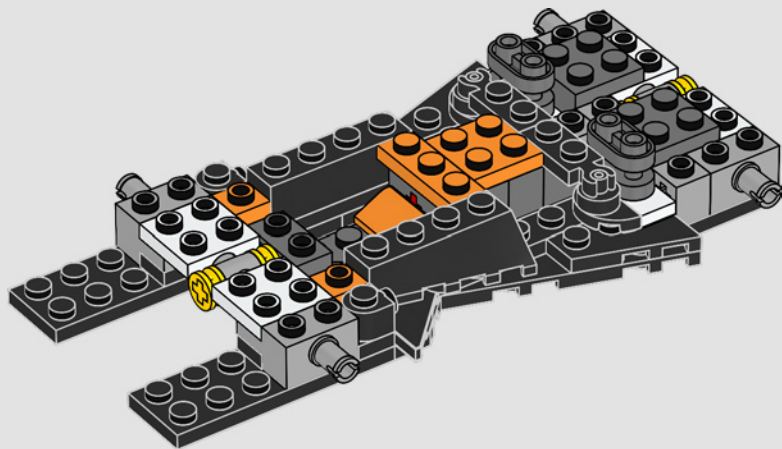

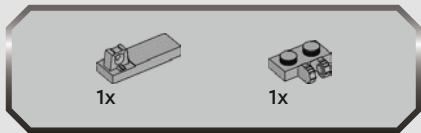

39

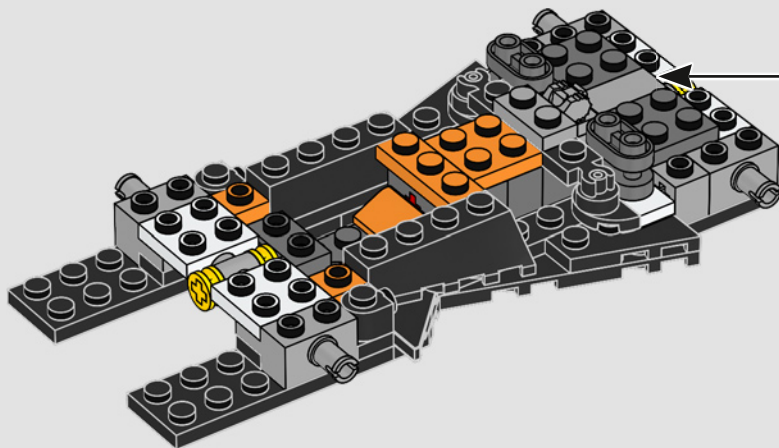
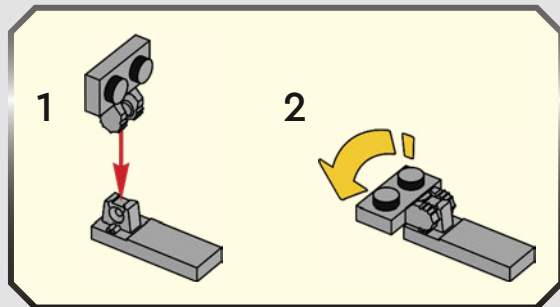



40

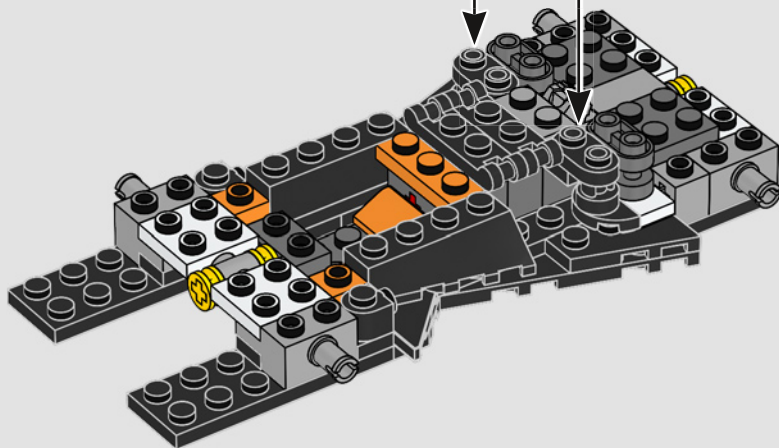



41

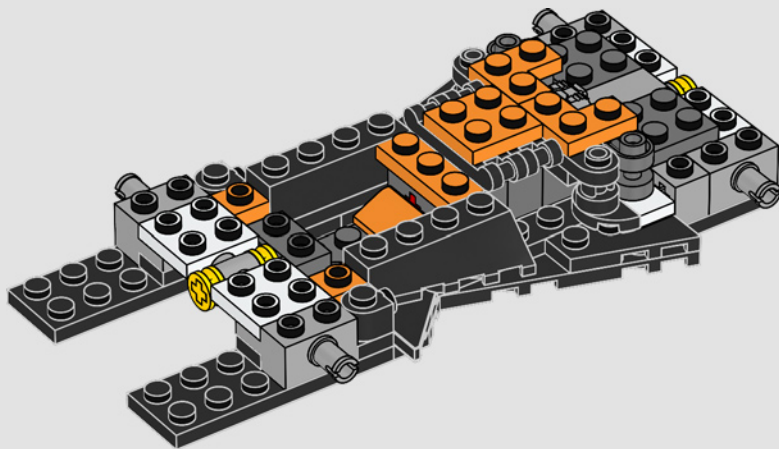

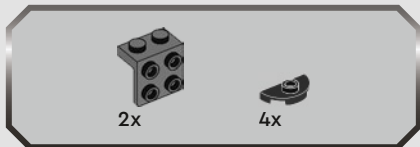

42

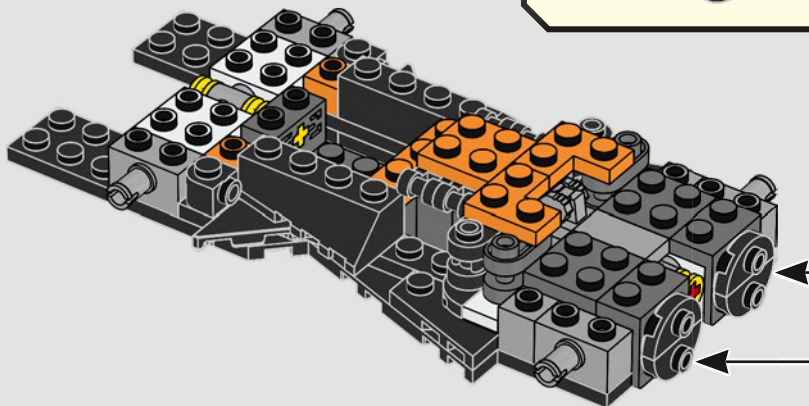
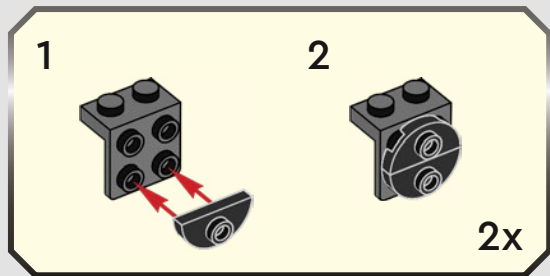

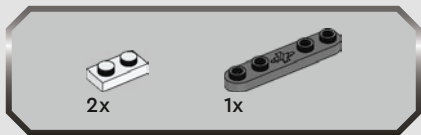

43

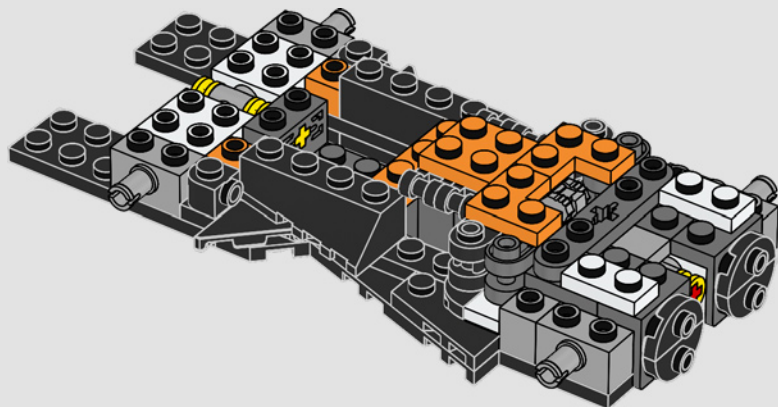

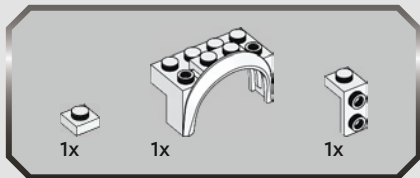

44

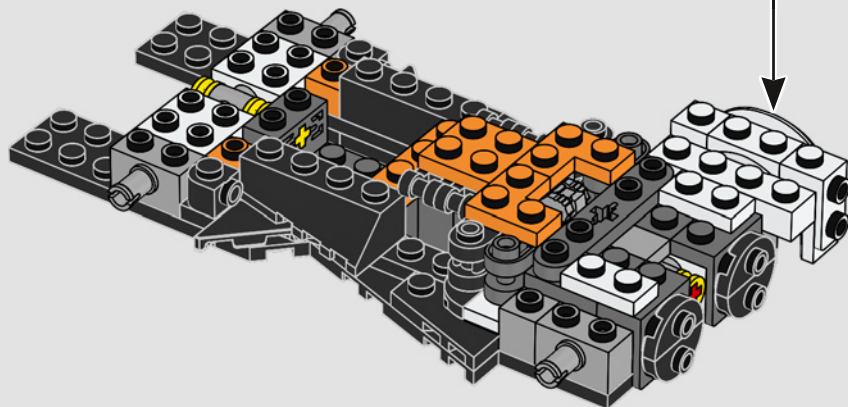
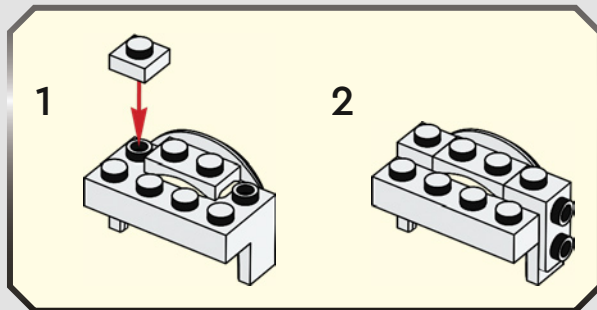



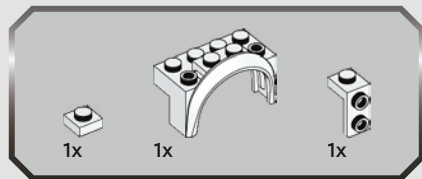

45

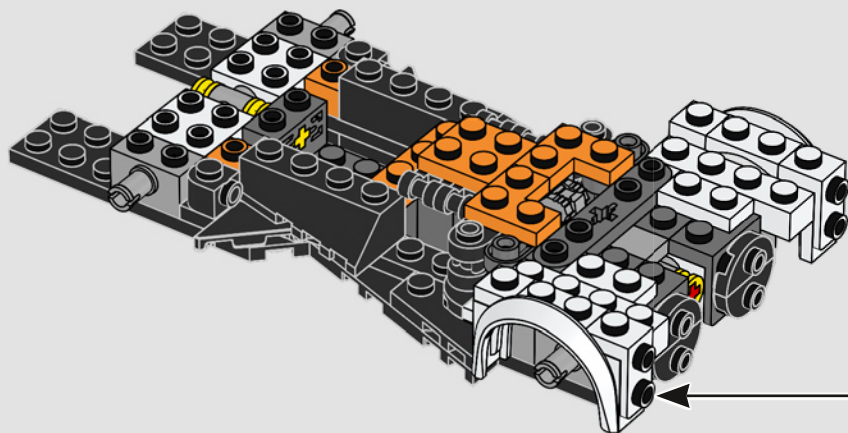
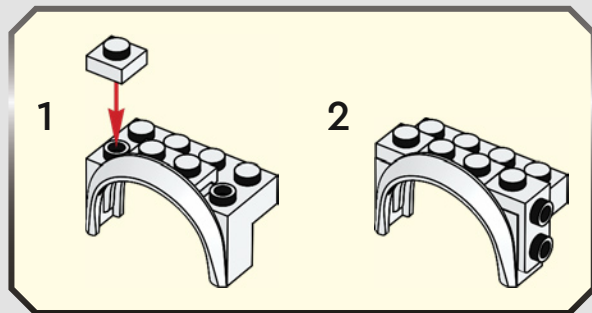



2x

46

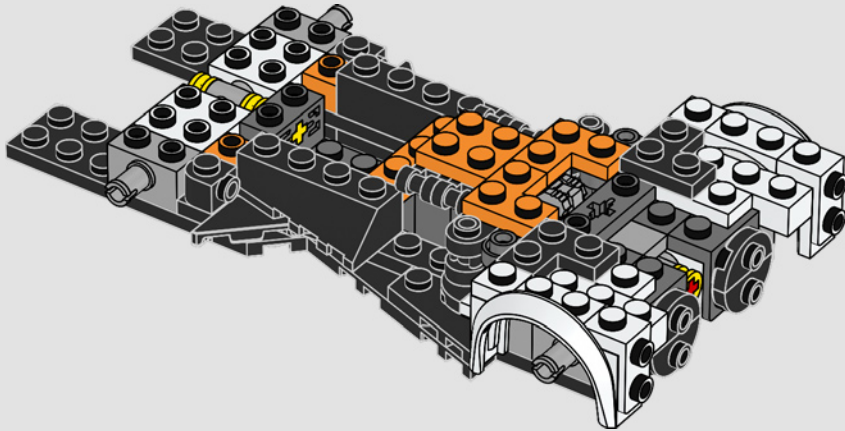

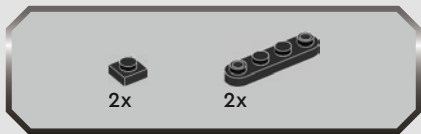

47

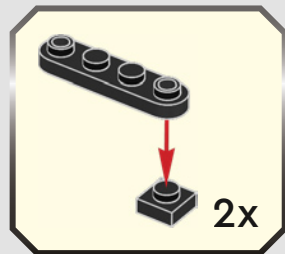
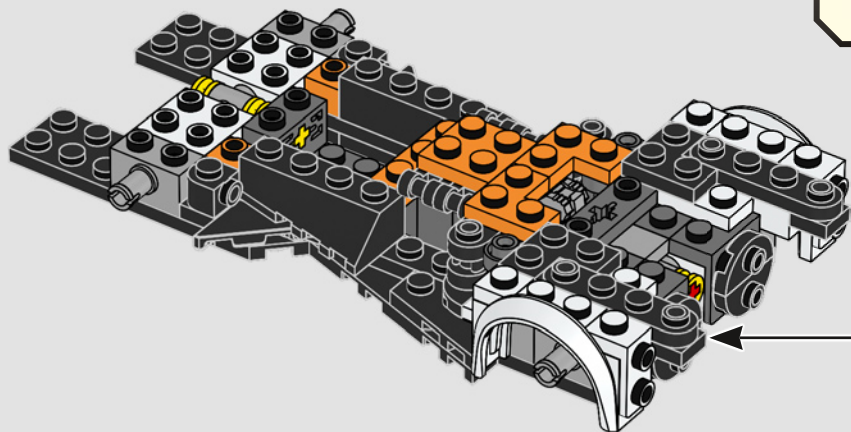



48

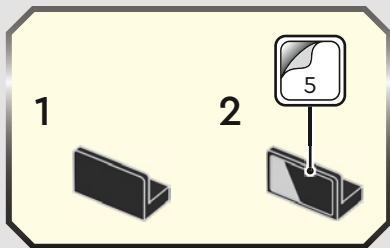
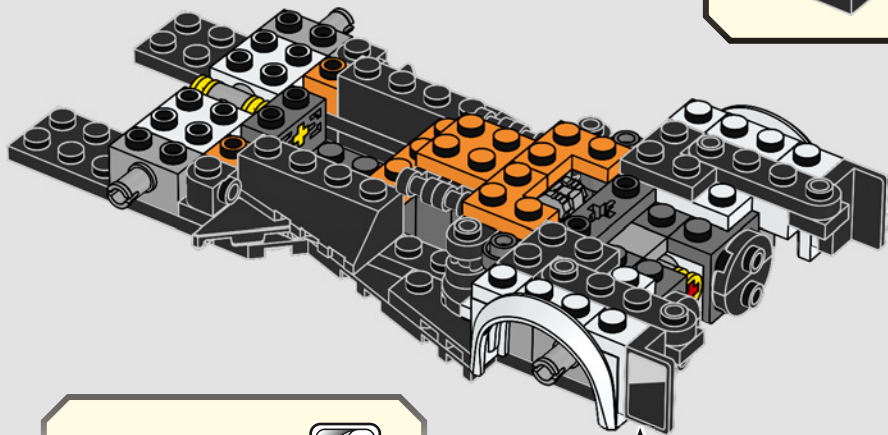
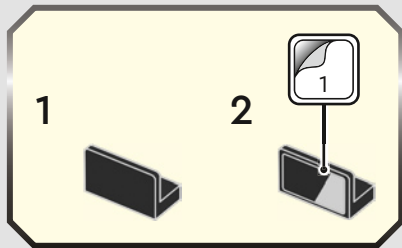

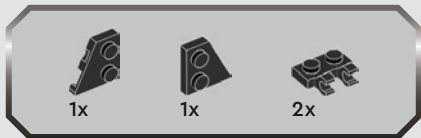

49

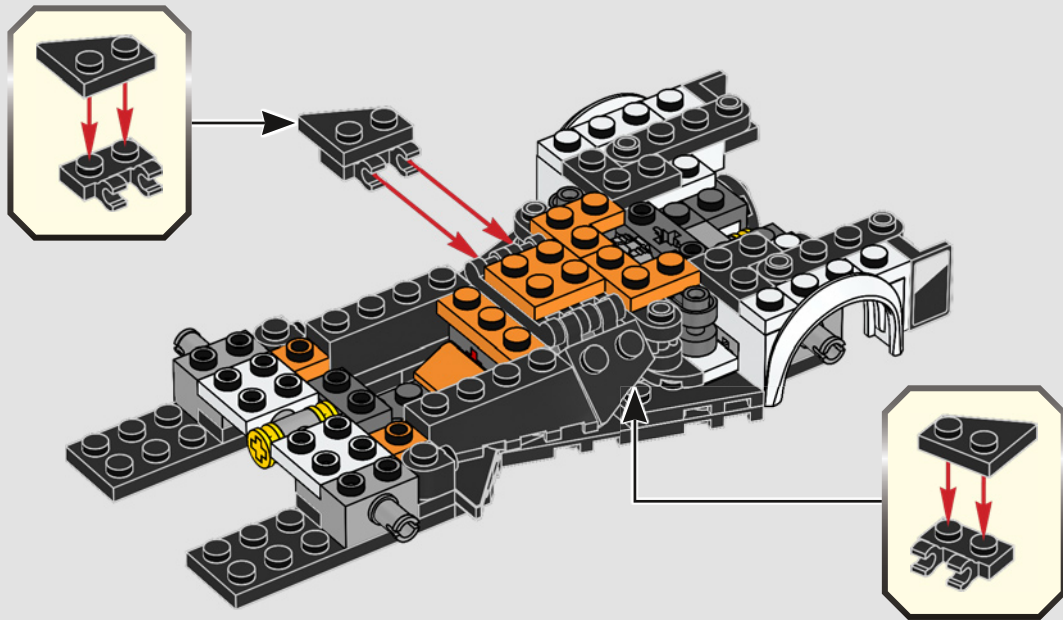

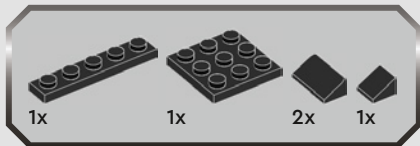

50

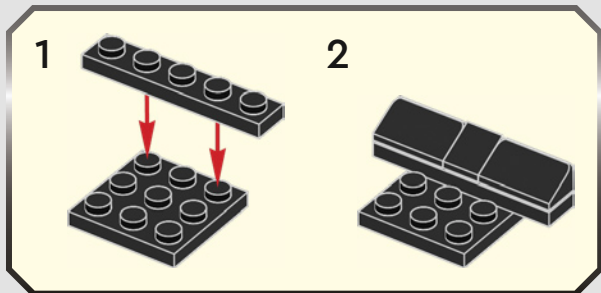

2

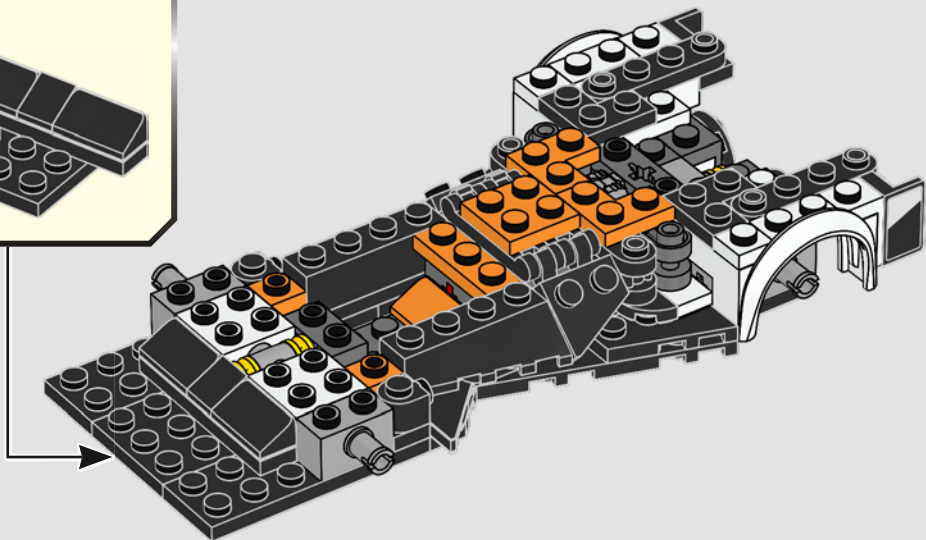
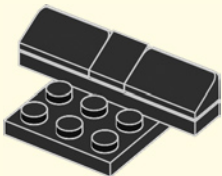



2x

51

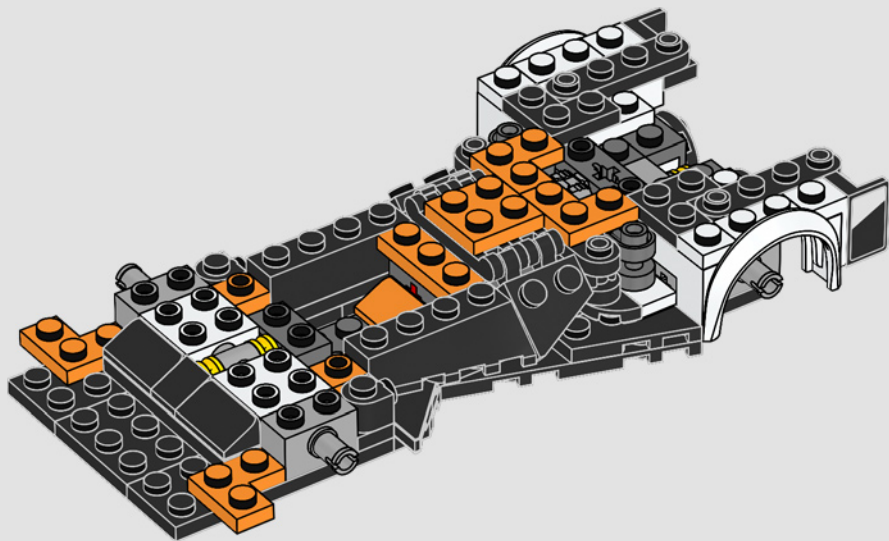

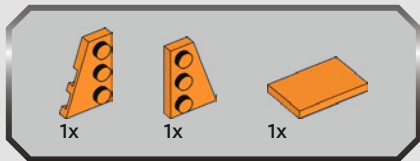

52

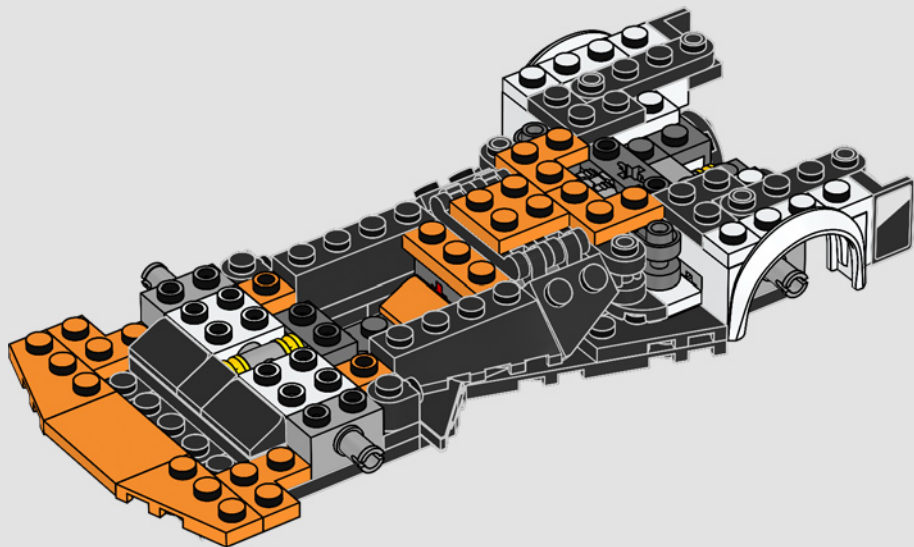





53

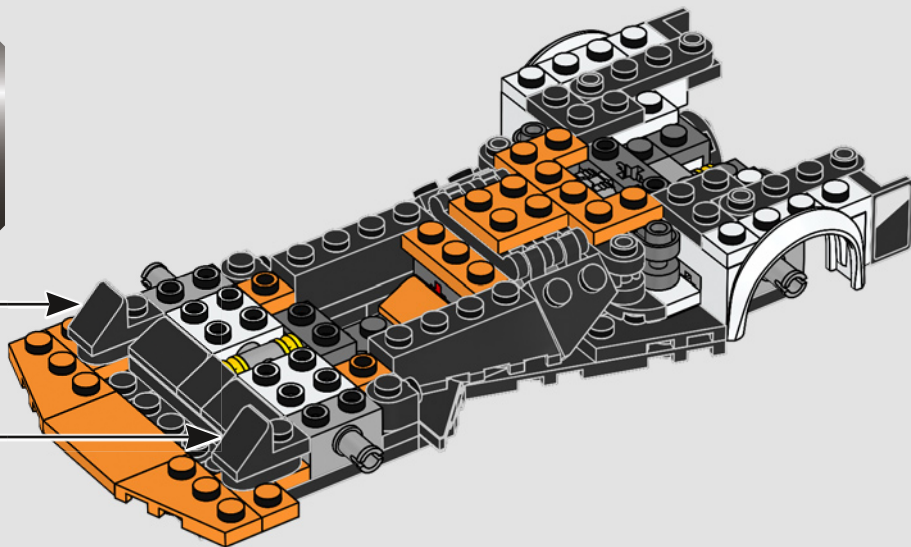
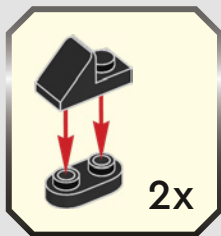



54

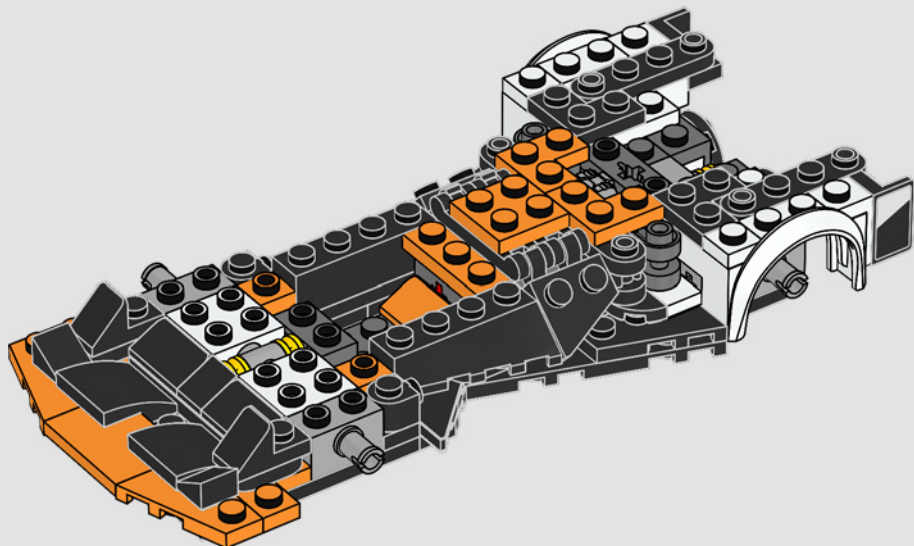

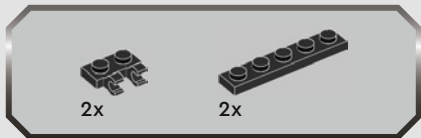

55

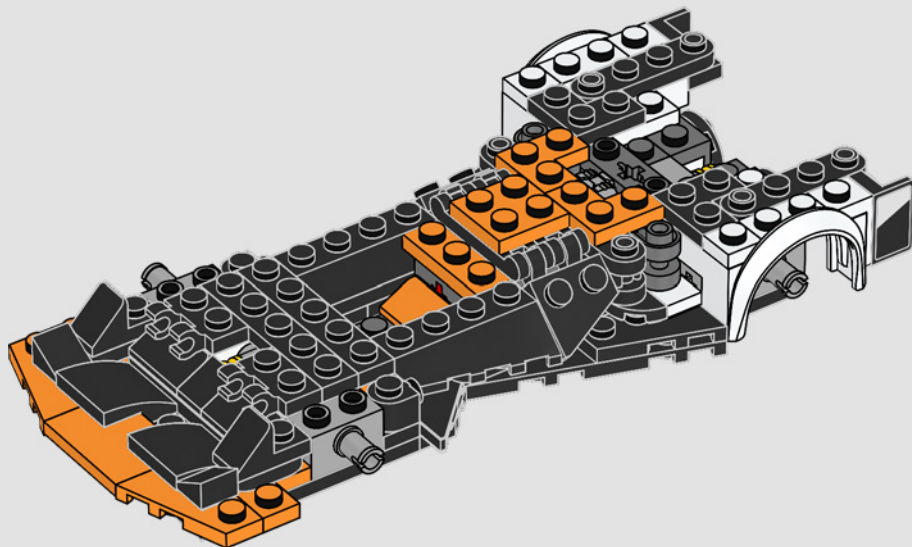

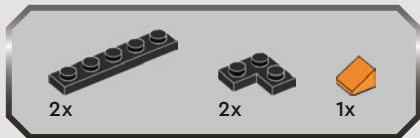

56

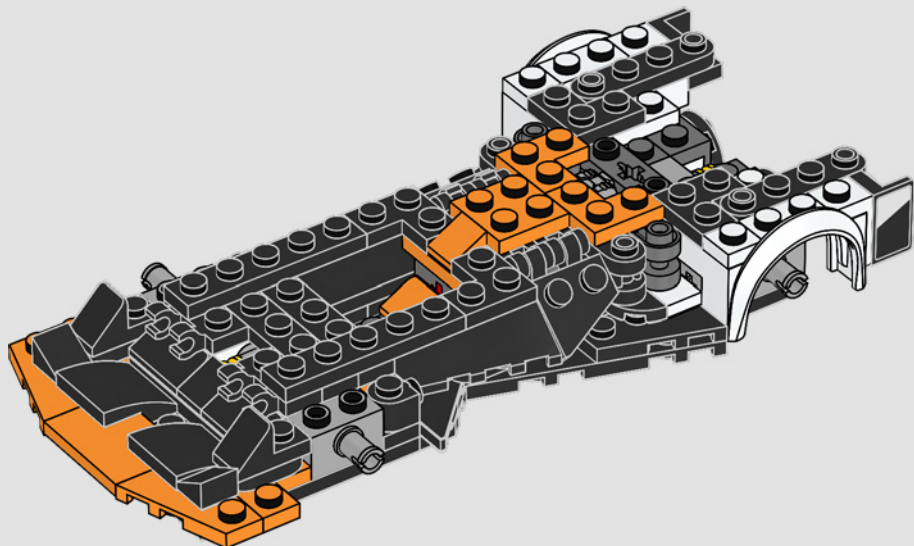

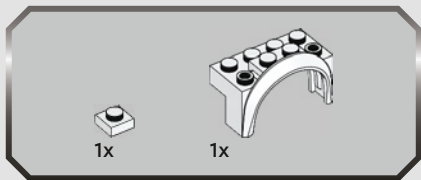

57

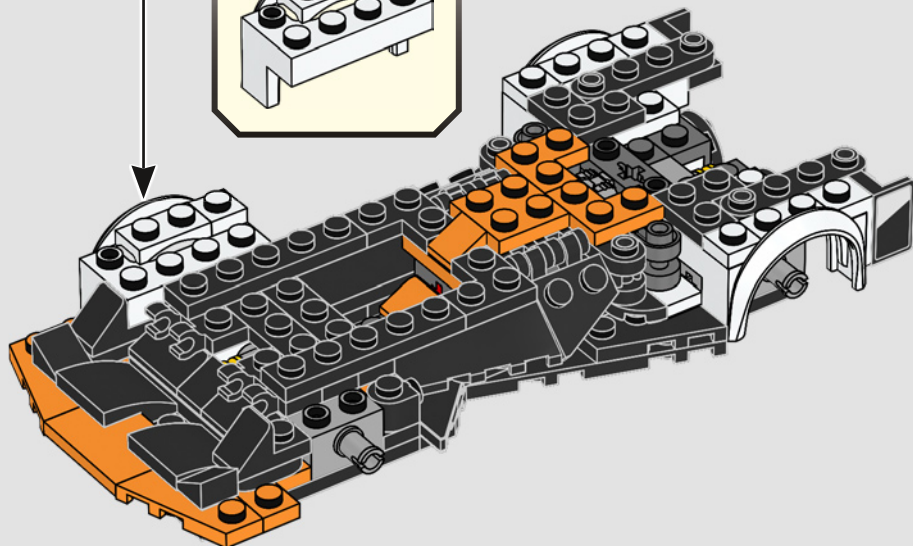
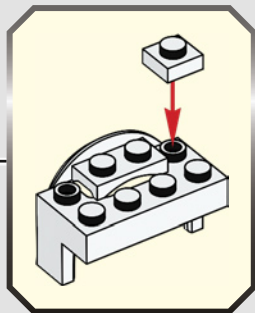

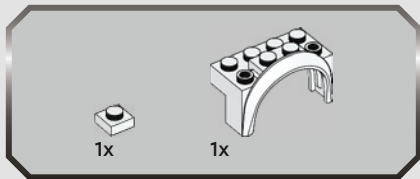

58

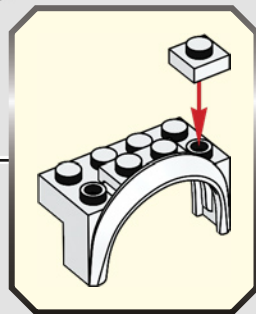
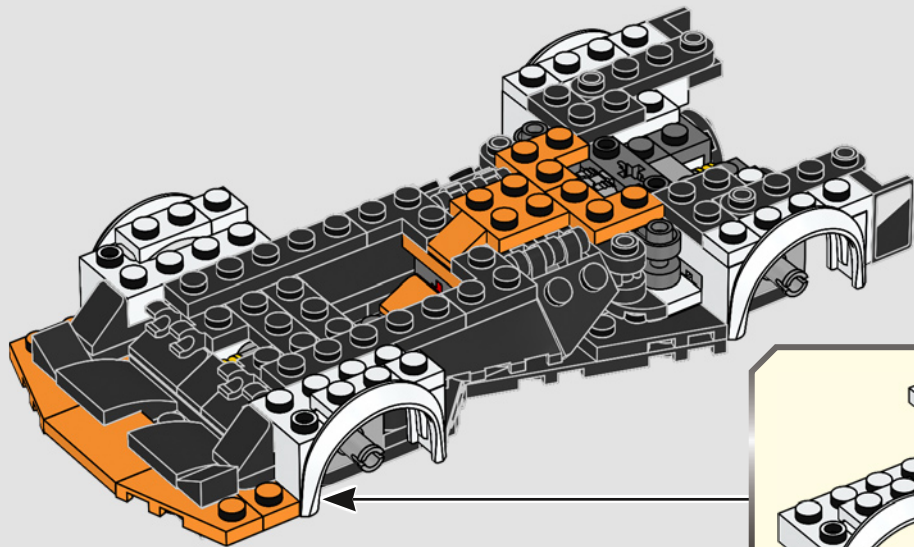



59

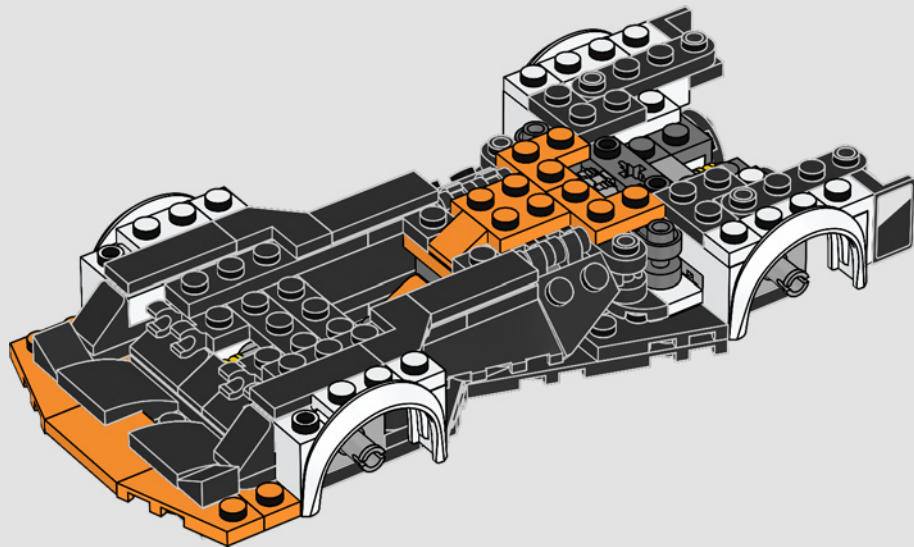

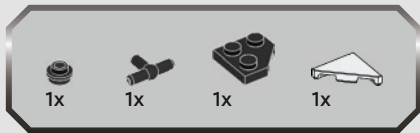

60

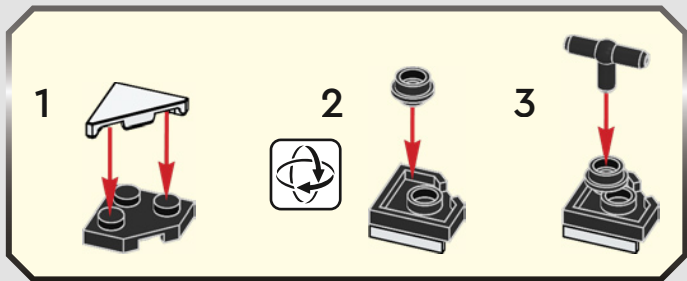
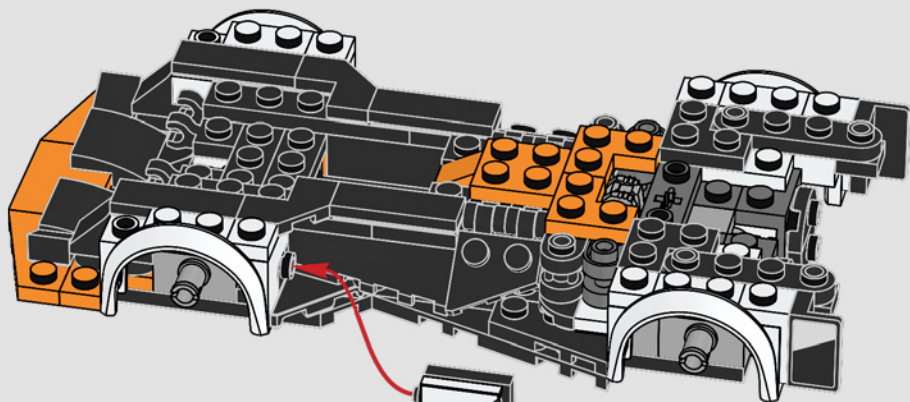



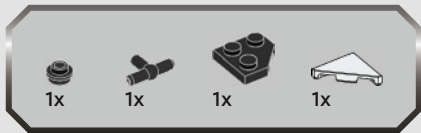

61

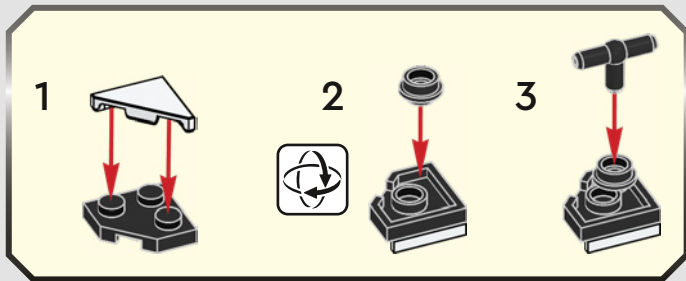
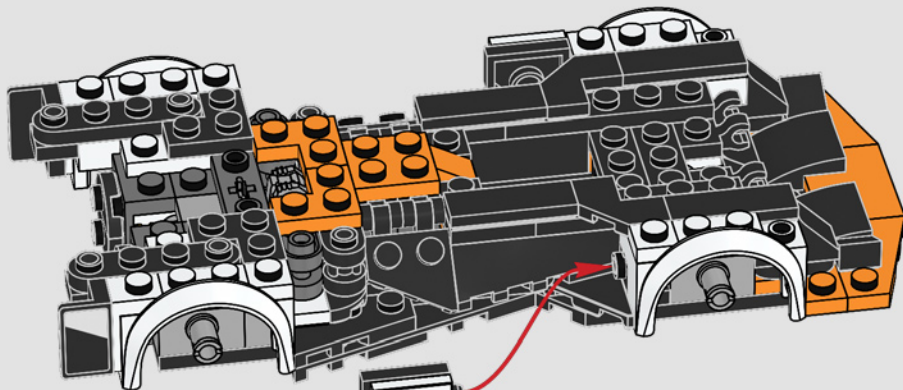



62

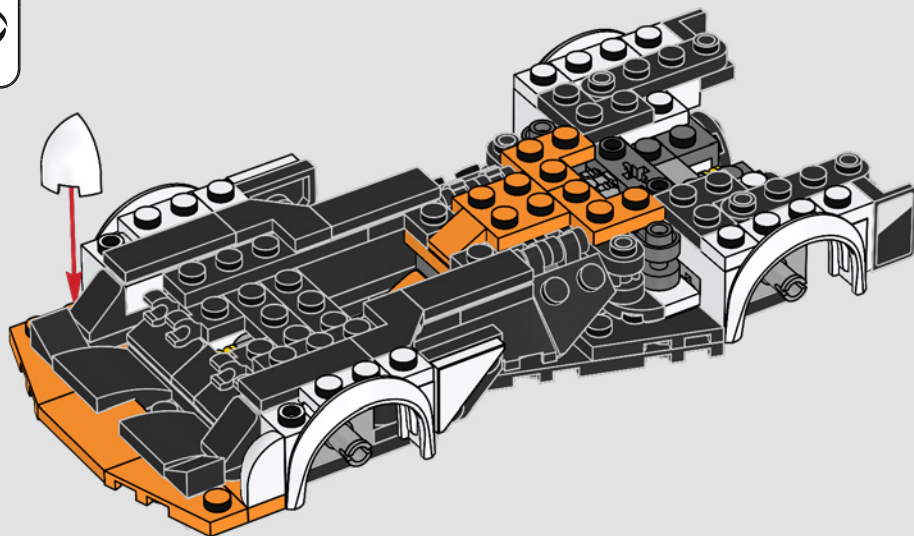



63

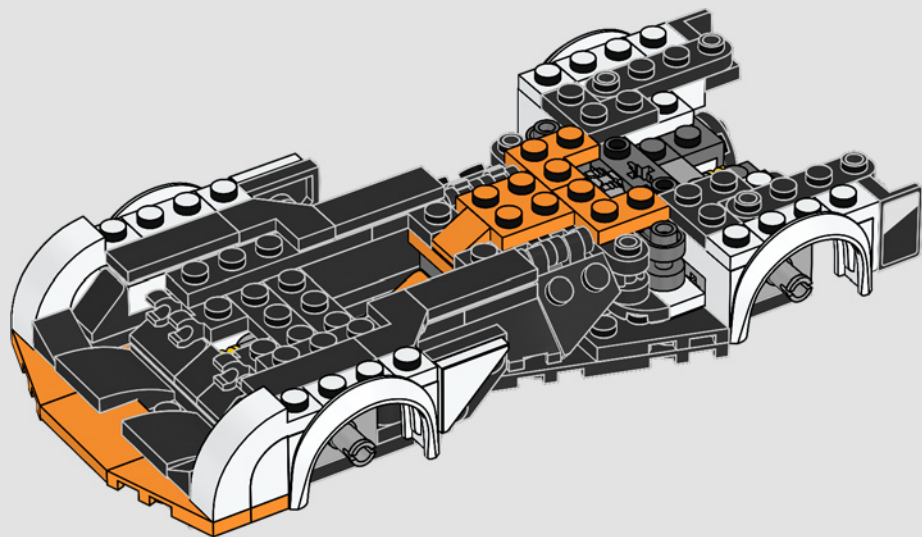

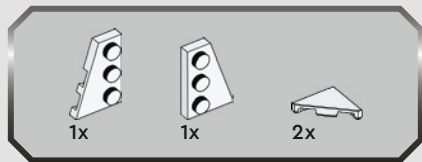

64

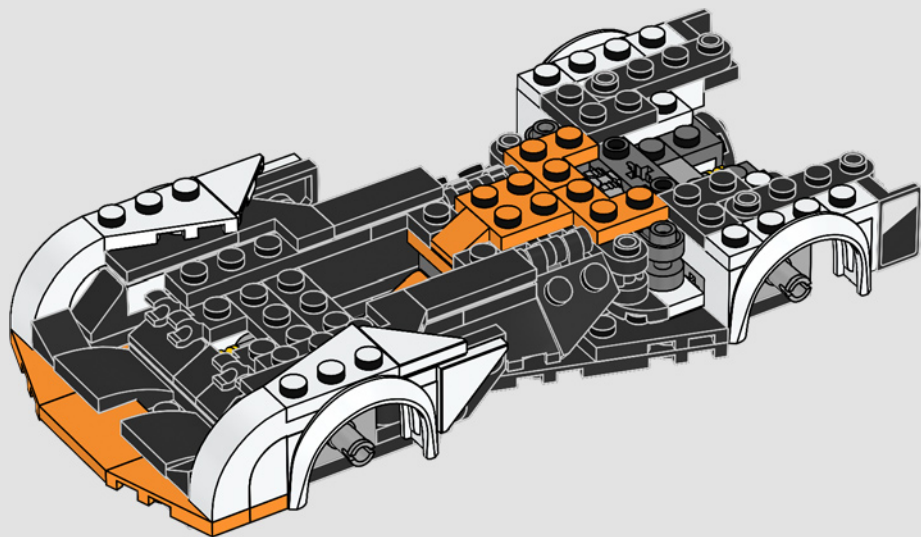



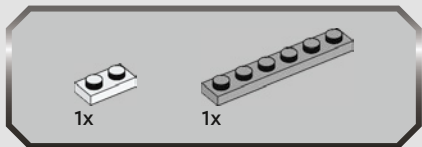
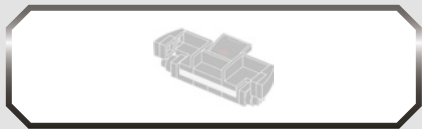

65

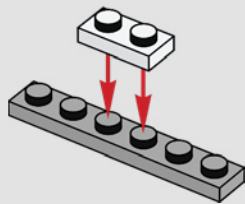

2x

66



2x

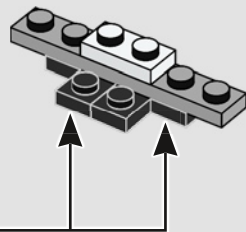

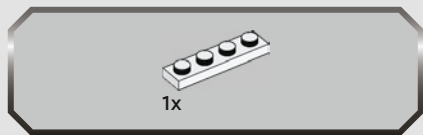

67

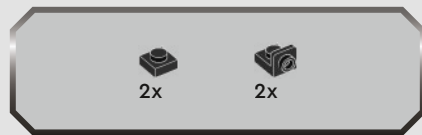
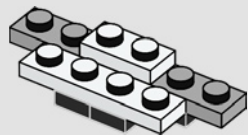

68

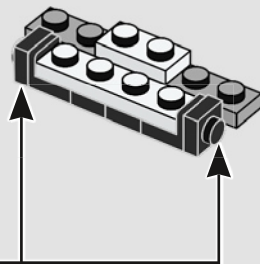
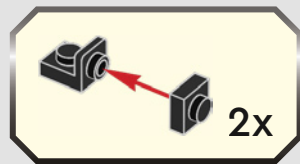



69

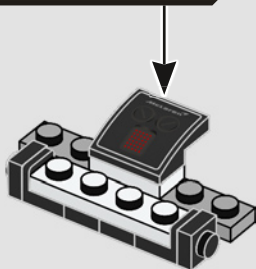
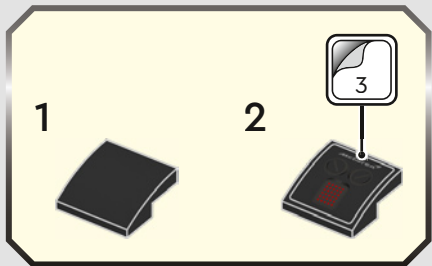

70

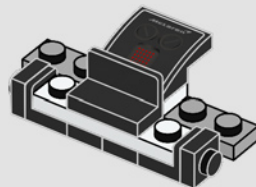





71

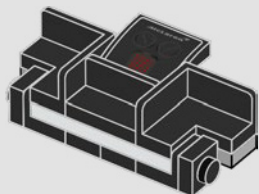

72

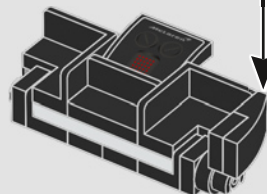
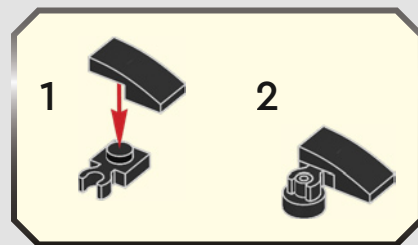

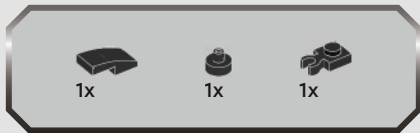

73

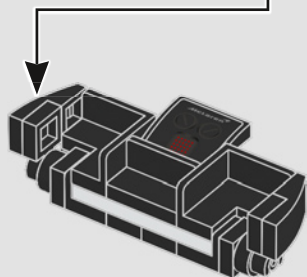
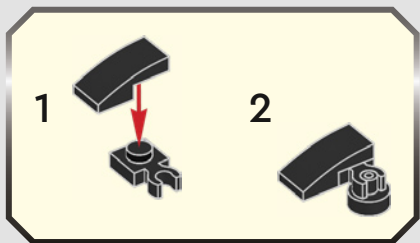

74

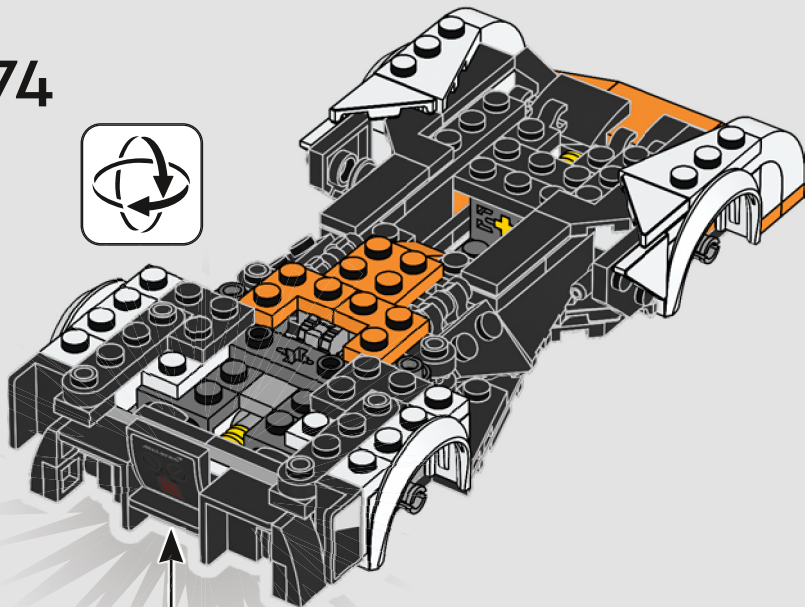



75

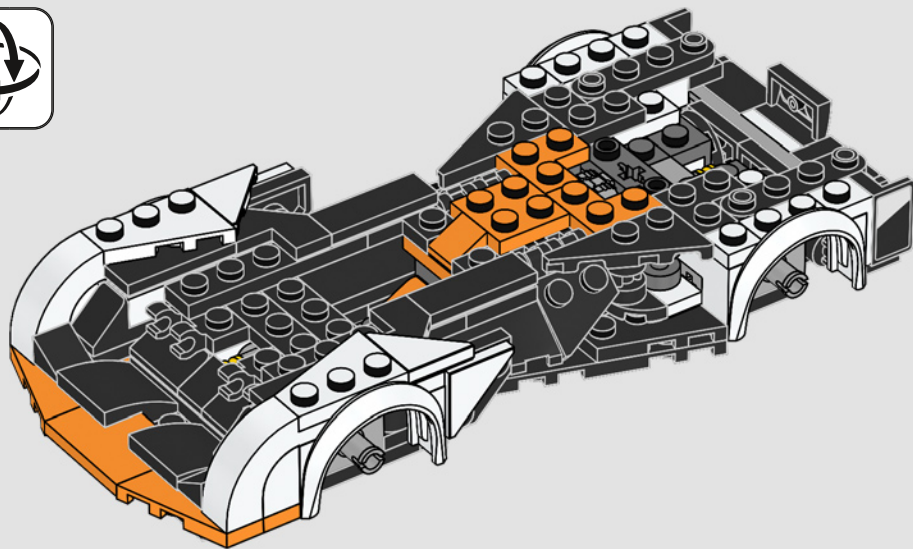

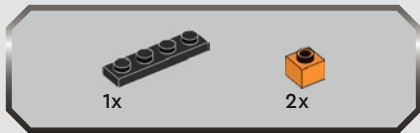

76

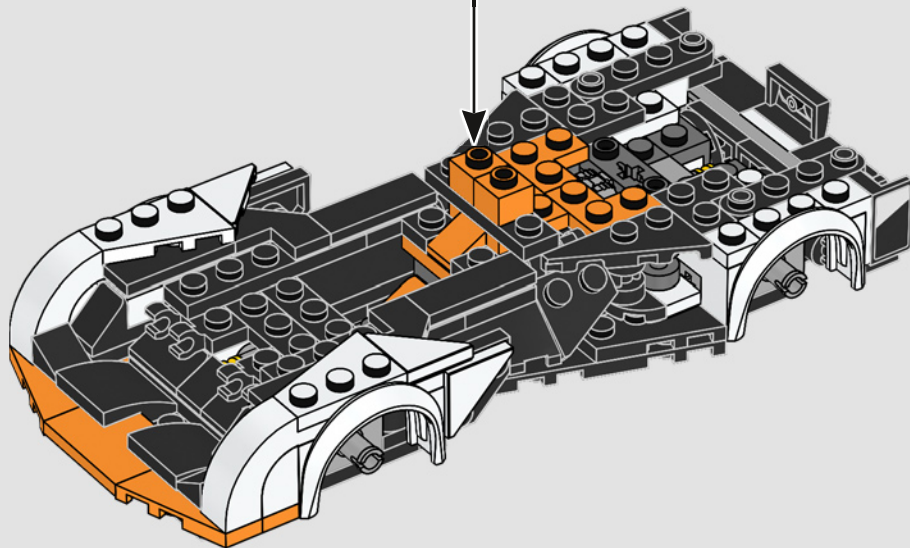
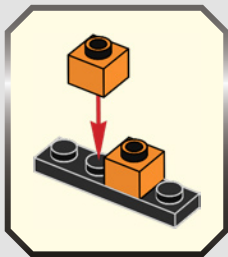

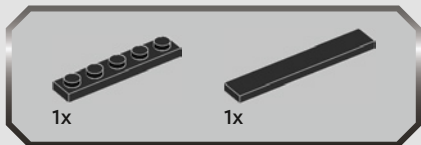
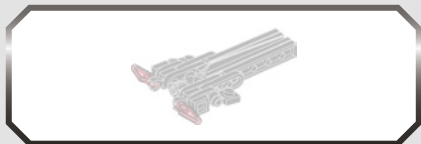

77

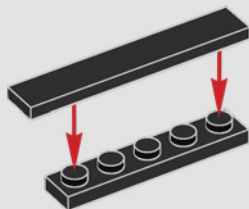

78

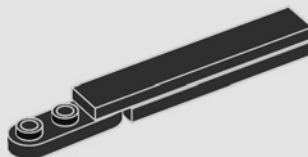

79

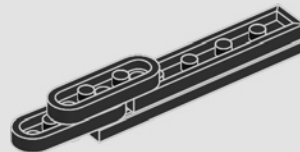



1x



1x

80

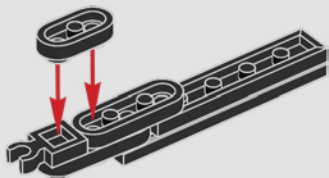

1x



1x

81

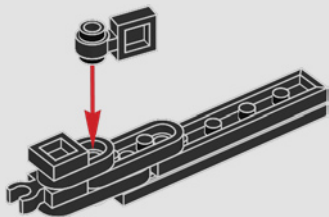

1x

82

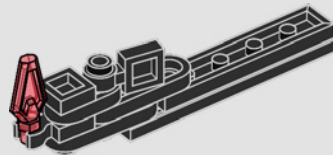

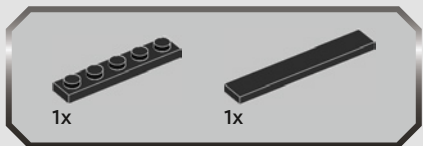
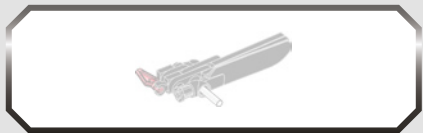

83

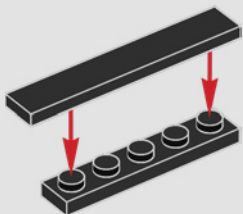

84

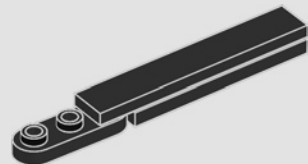

85

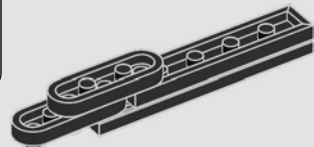



1x



1x

86

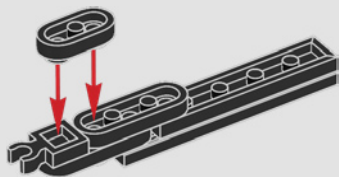

1x



1x

87

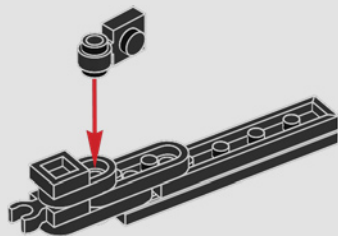



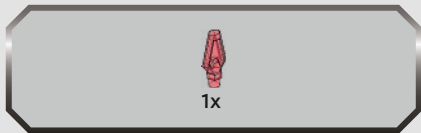

88

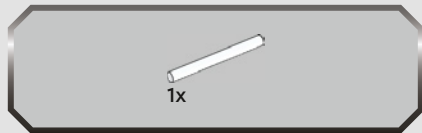
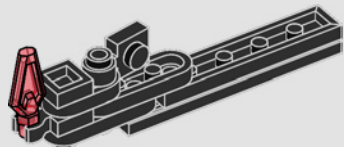

89

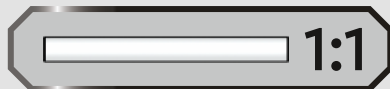
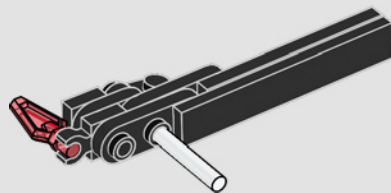

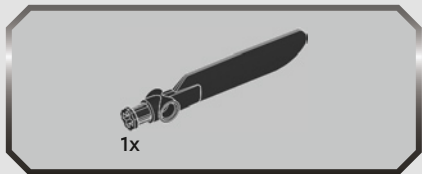

90

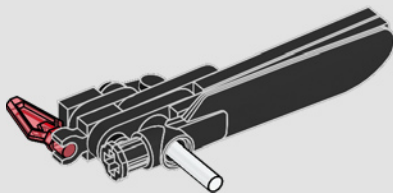

91

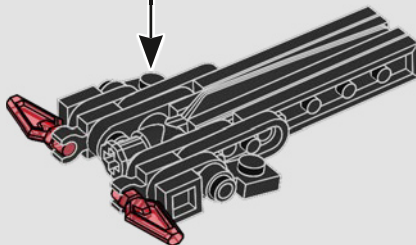

92

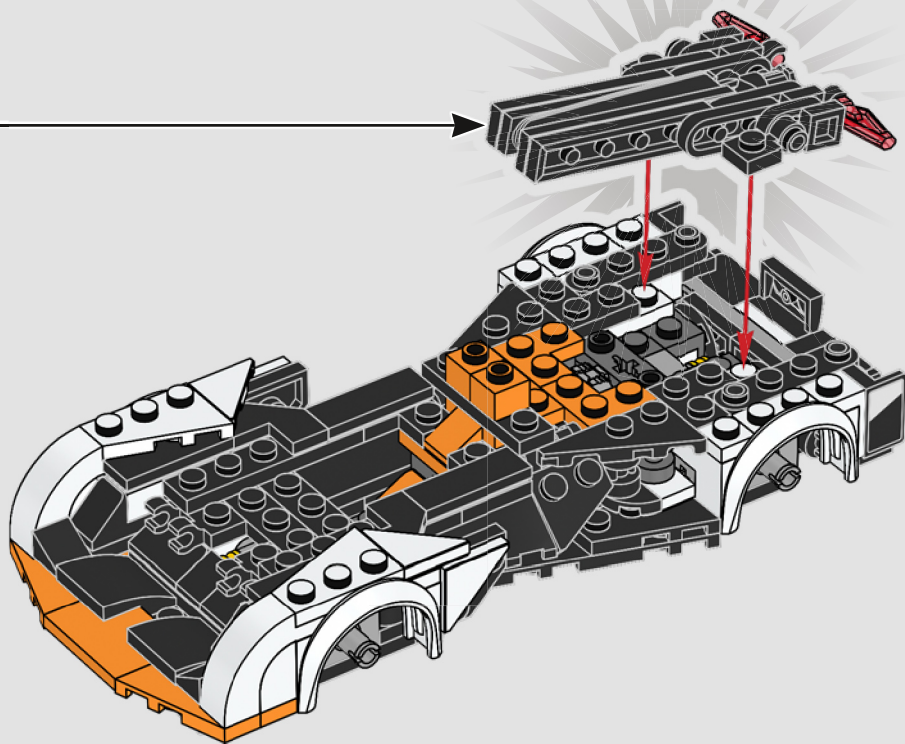



93

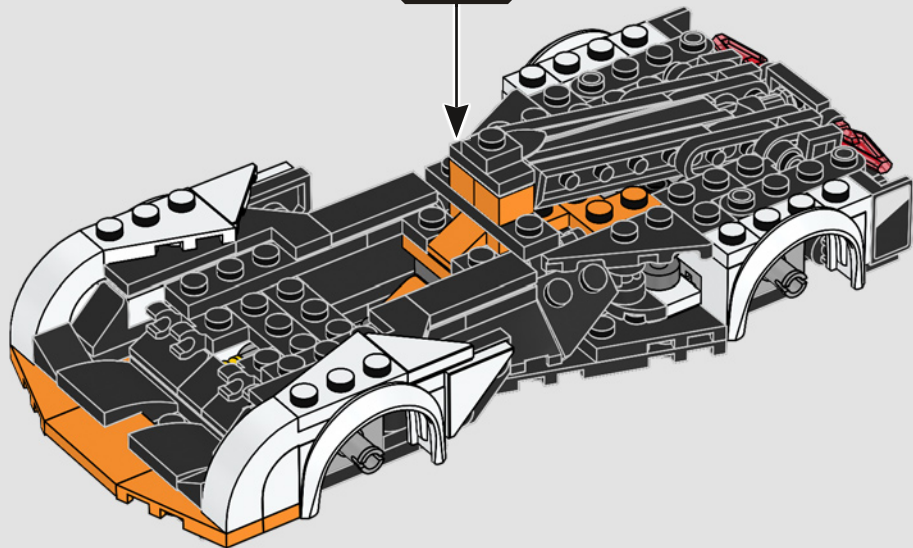
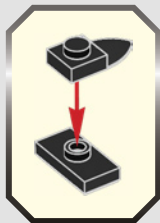

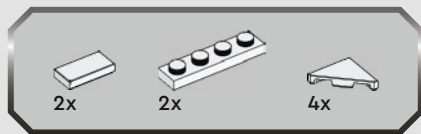

94

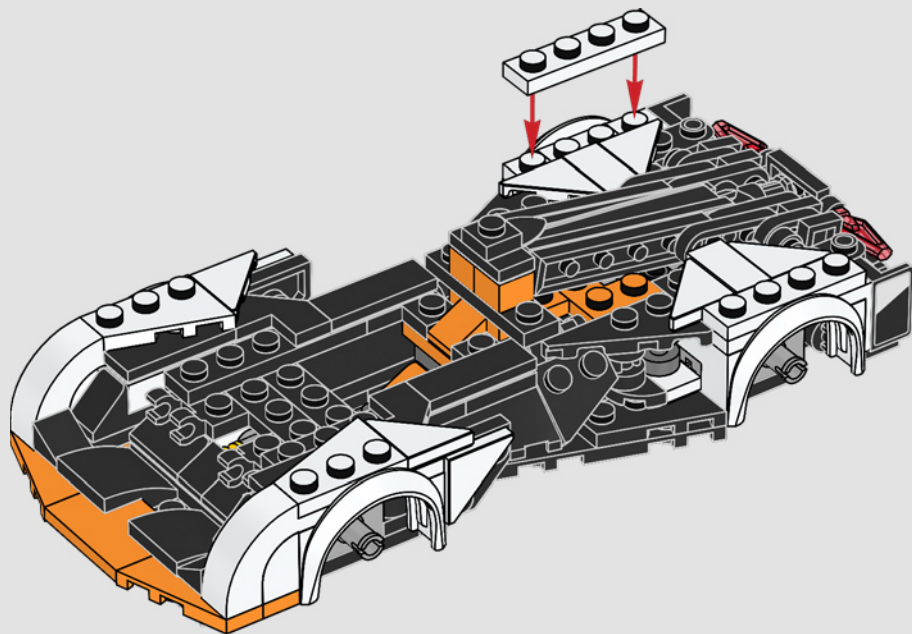



2x



4x

95

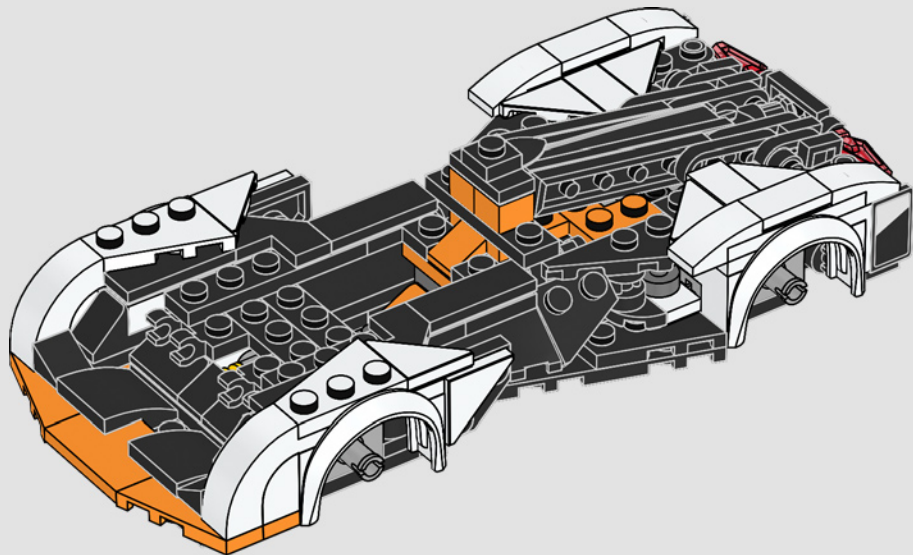



2x

96

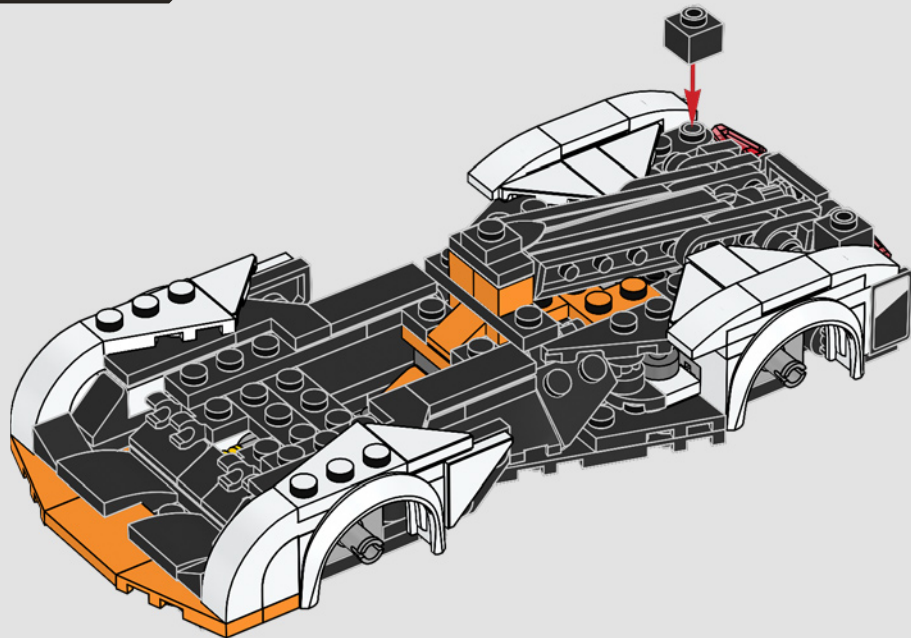

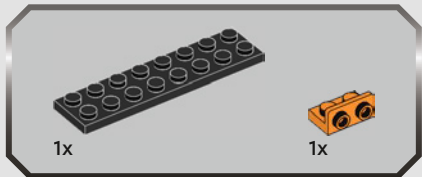
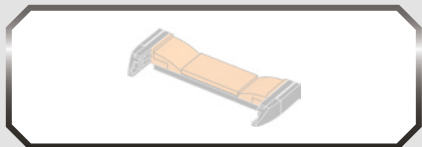

97

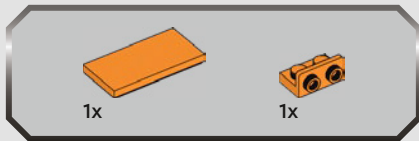
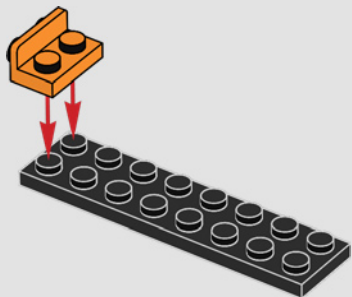

98

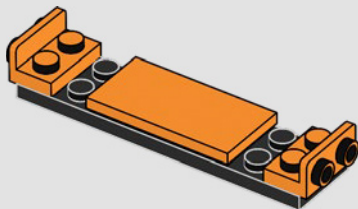





99

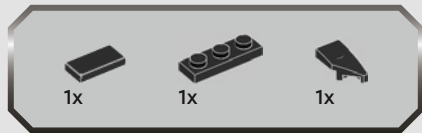
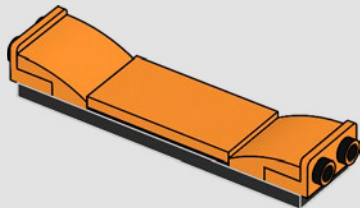

100

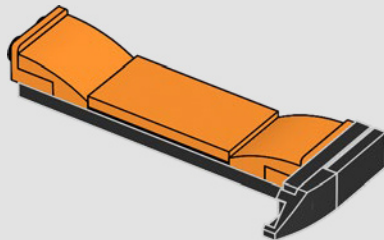
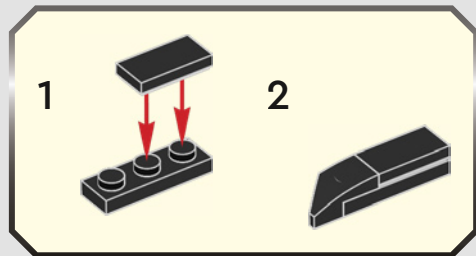



101

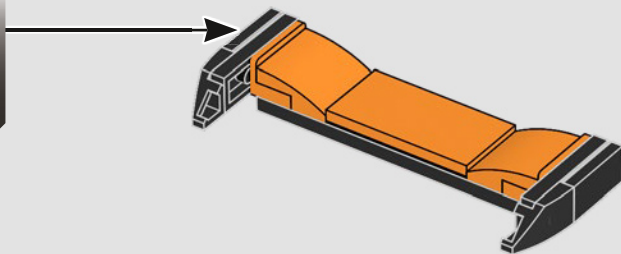
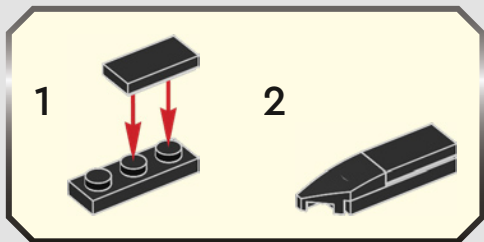

102

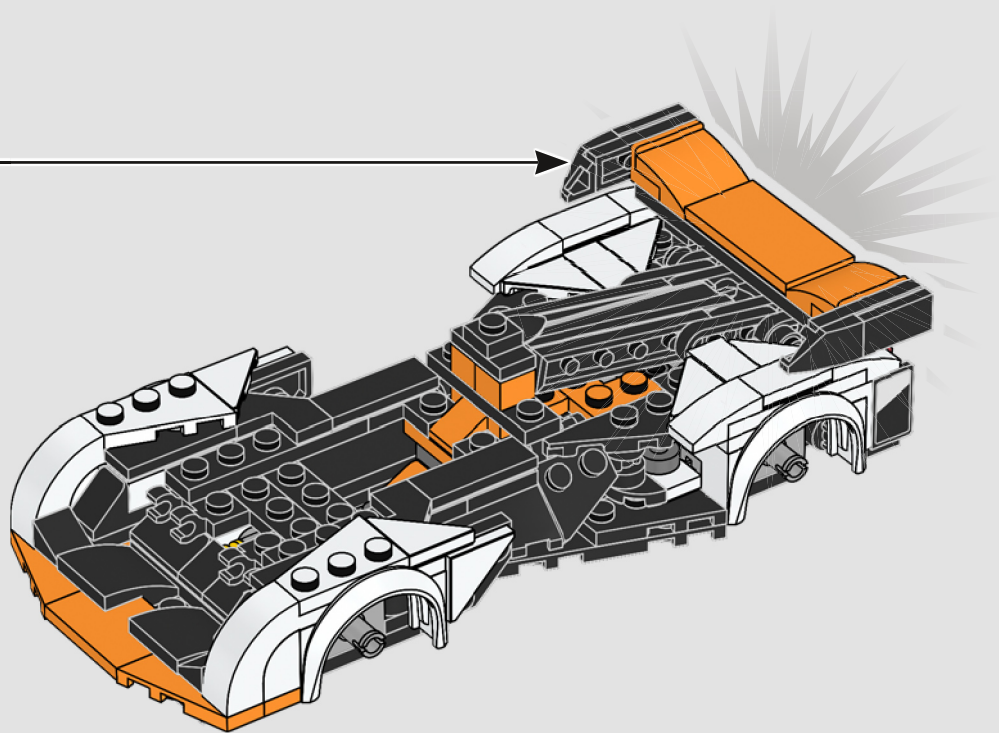

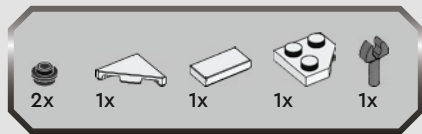

# 103

1

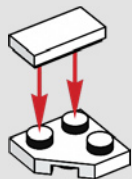

2



3

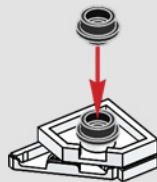

4

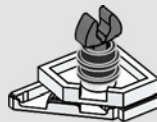

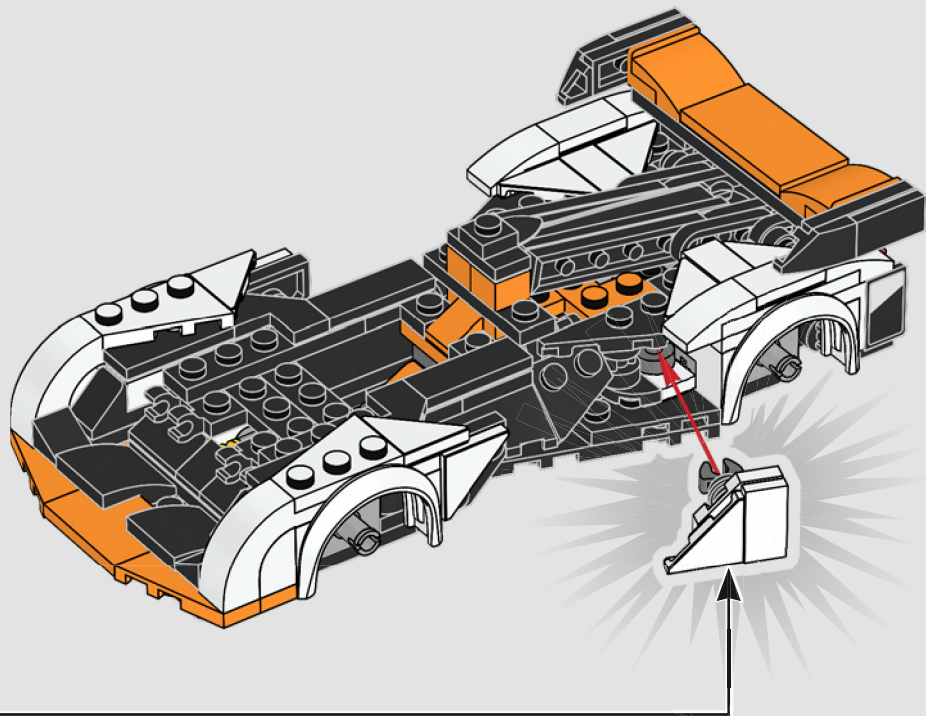

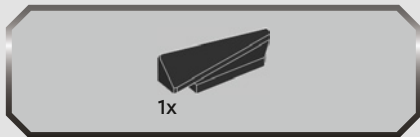

104

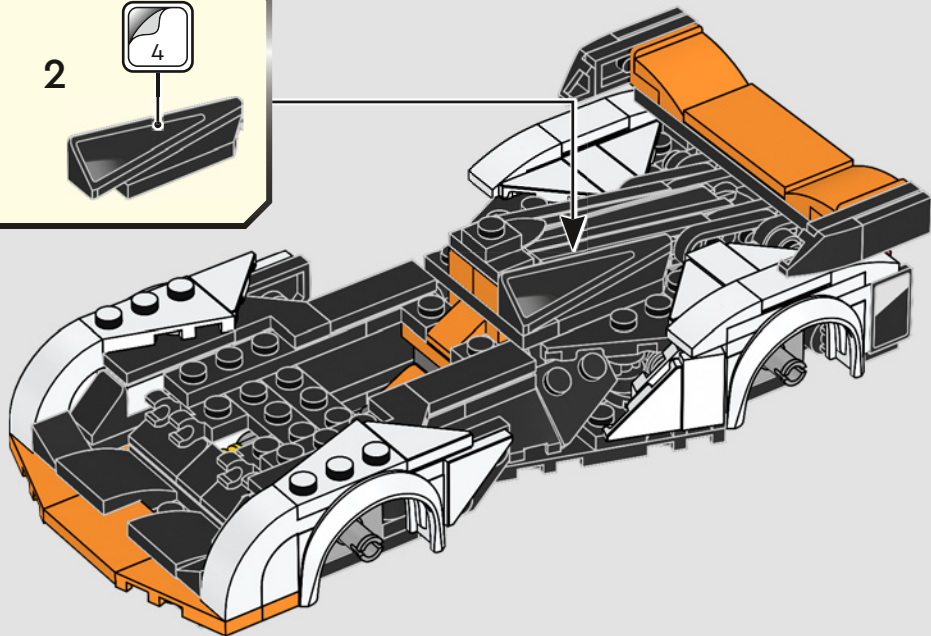
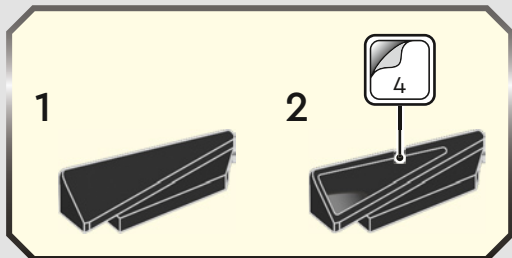

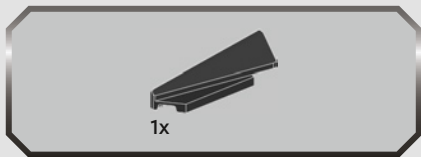

105

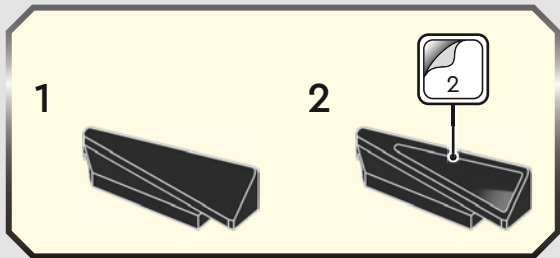
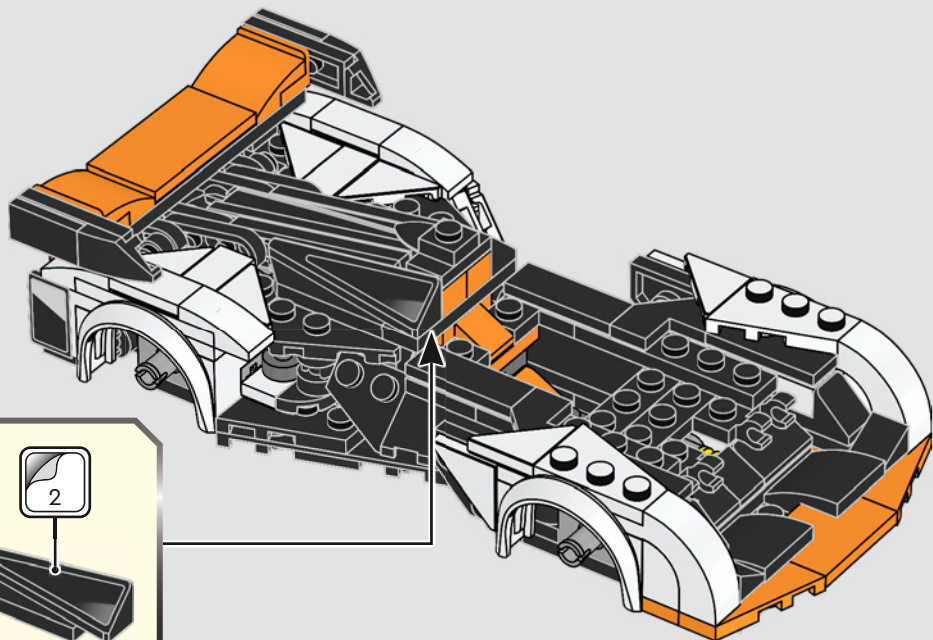

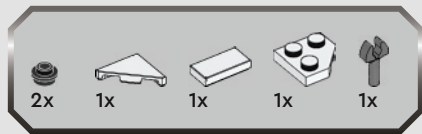

106

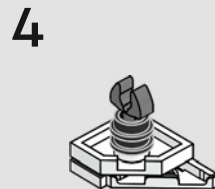
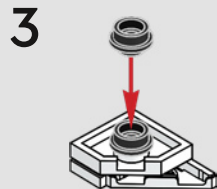
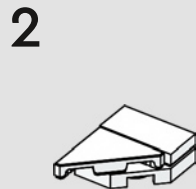
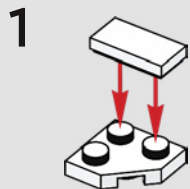



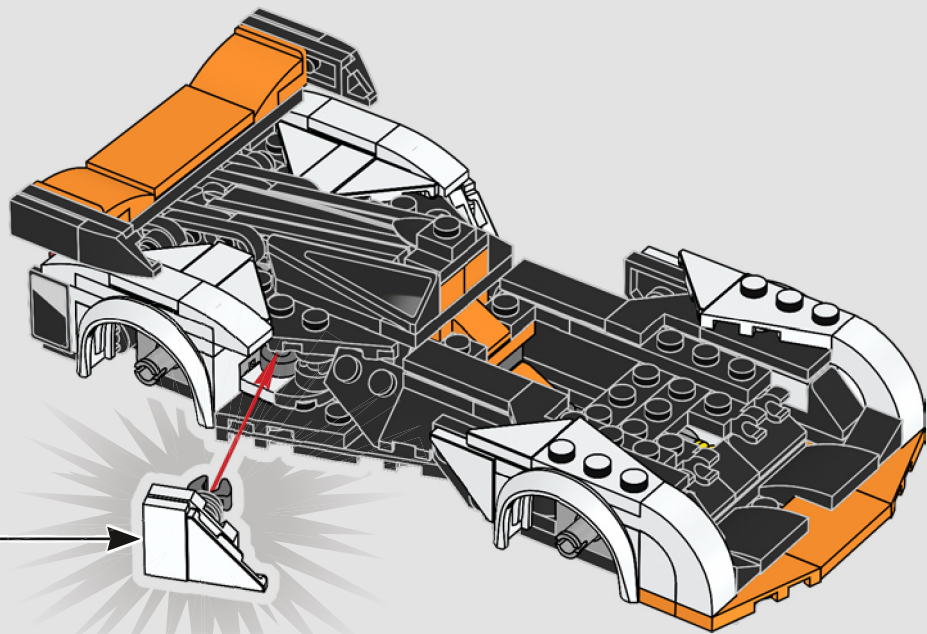



107

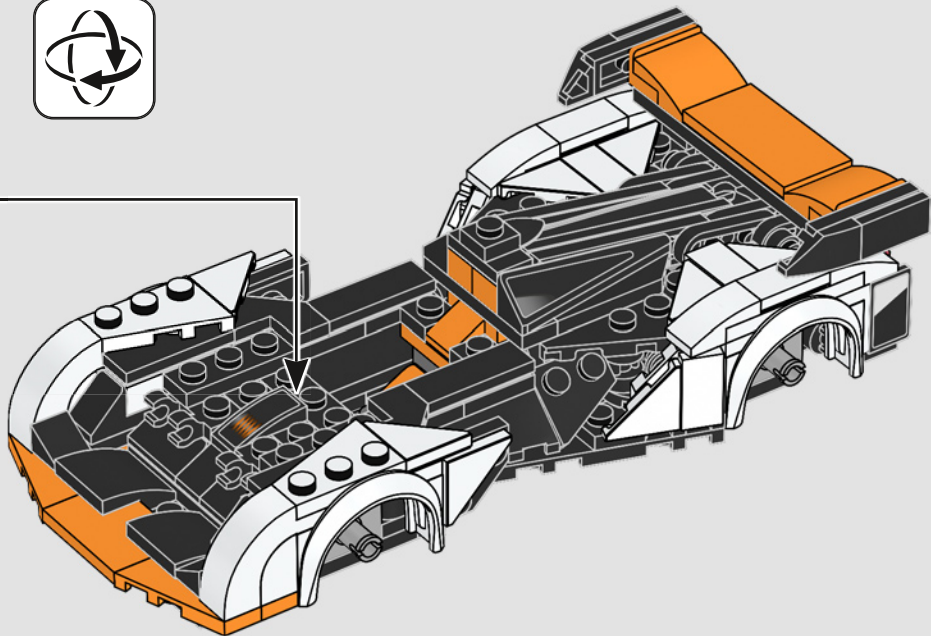
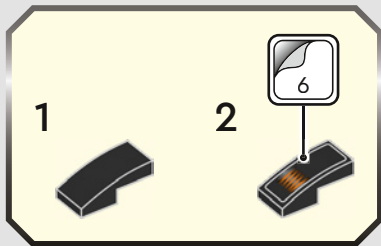

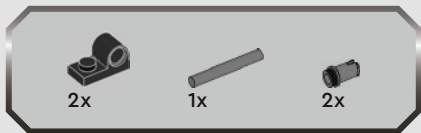

108

1



2

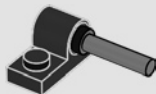

3

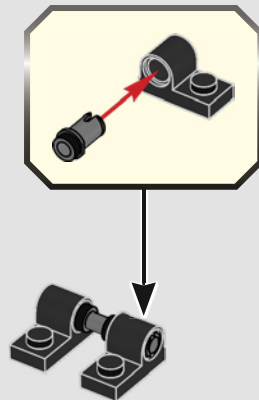

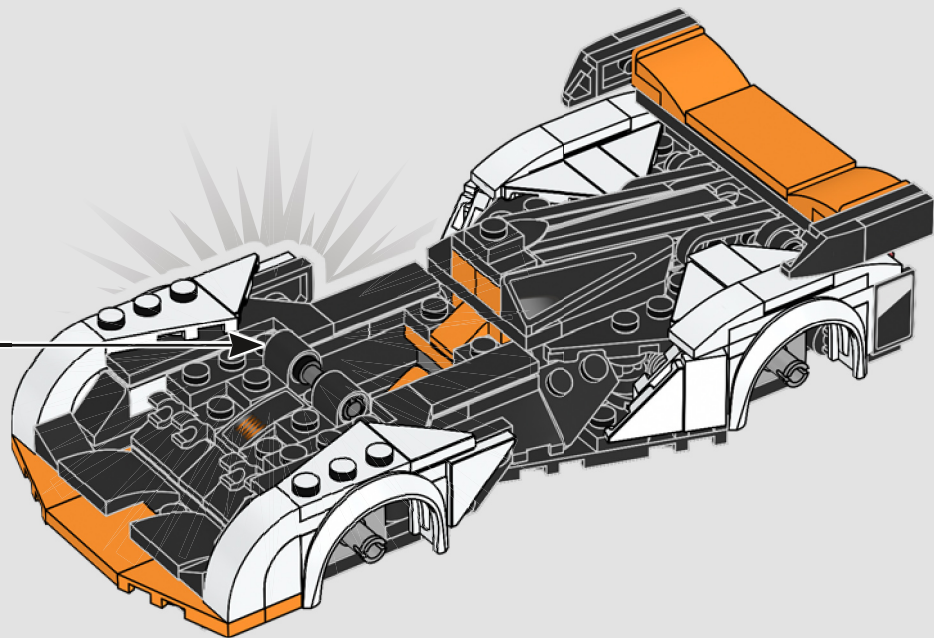



109

1



2



3



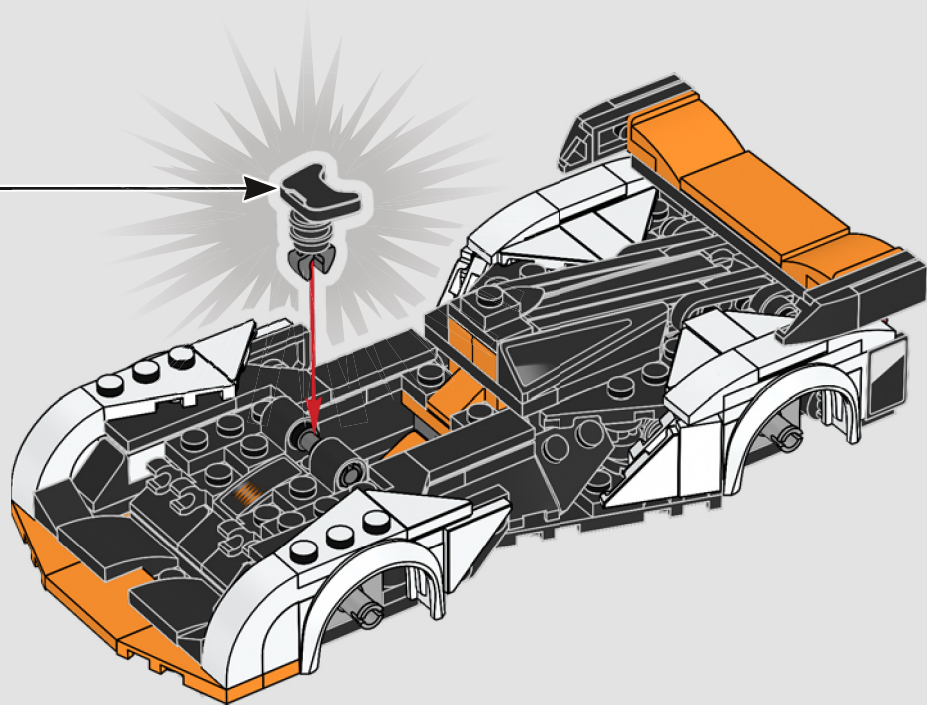

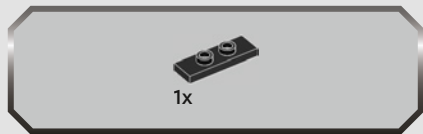

110

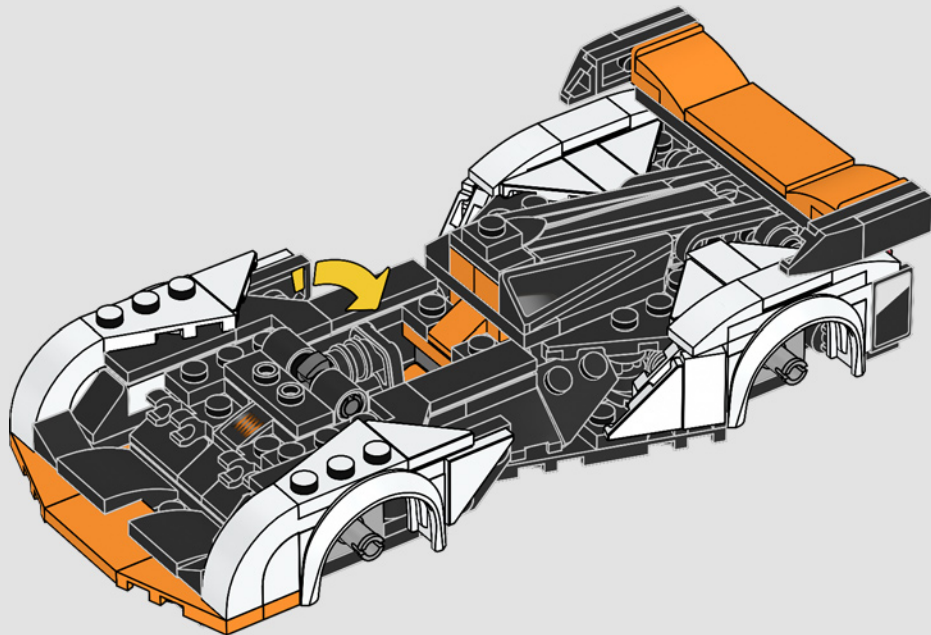

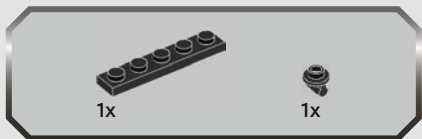

111

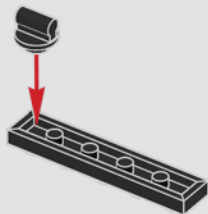

112

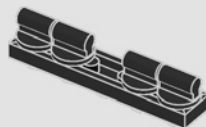

113

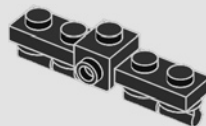





114

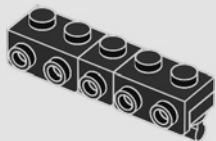

115

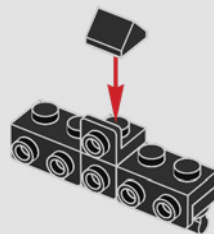



116

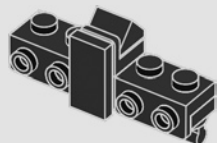

117

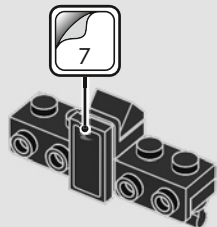

118

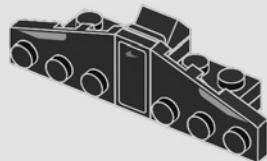

119

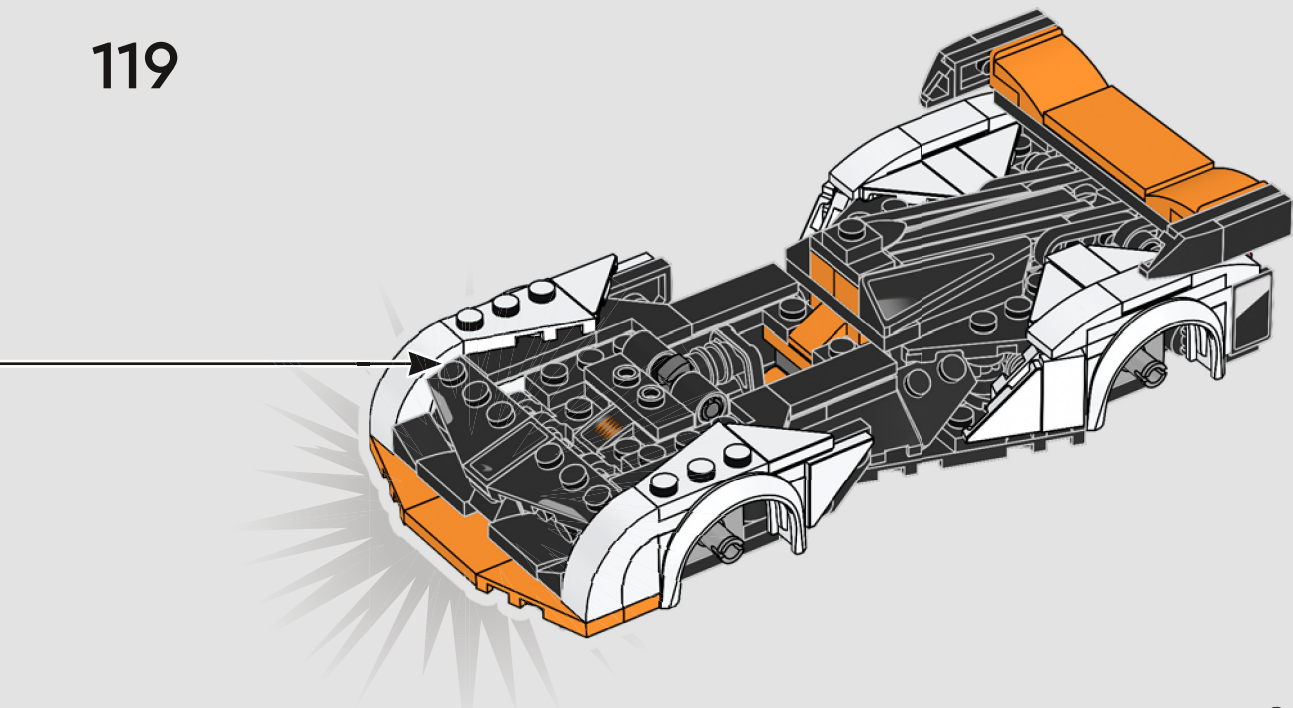



120

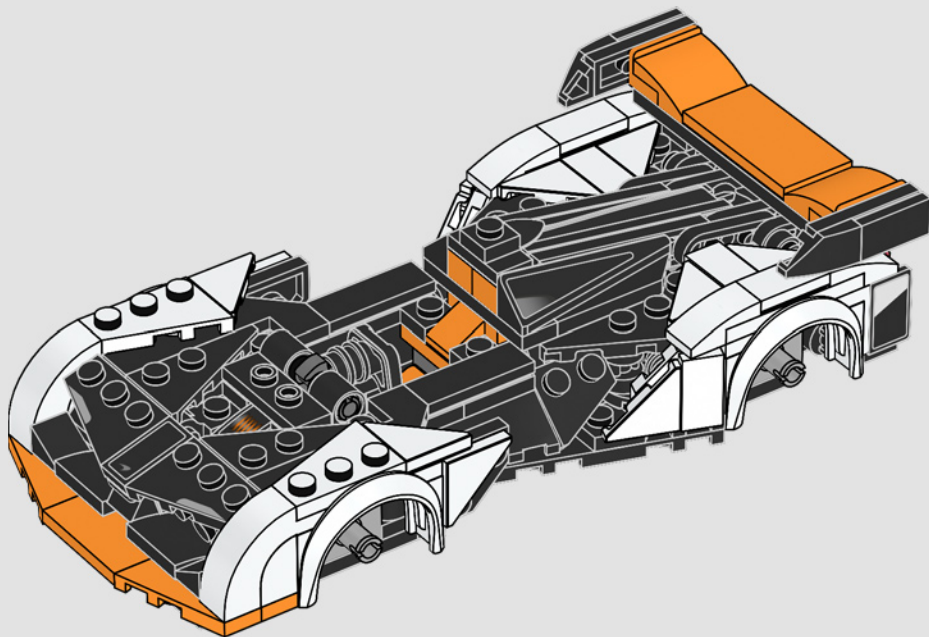



121

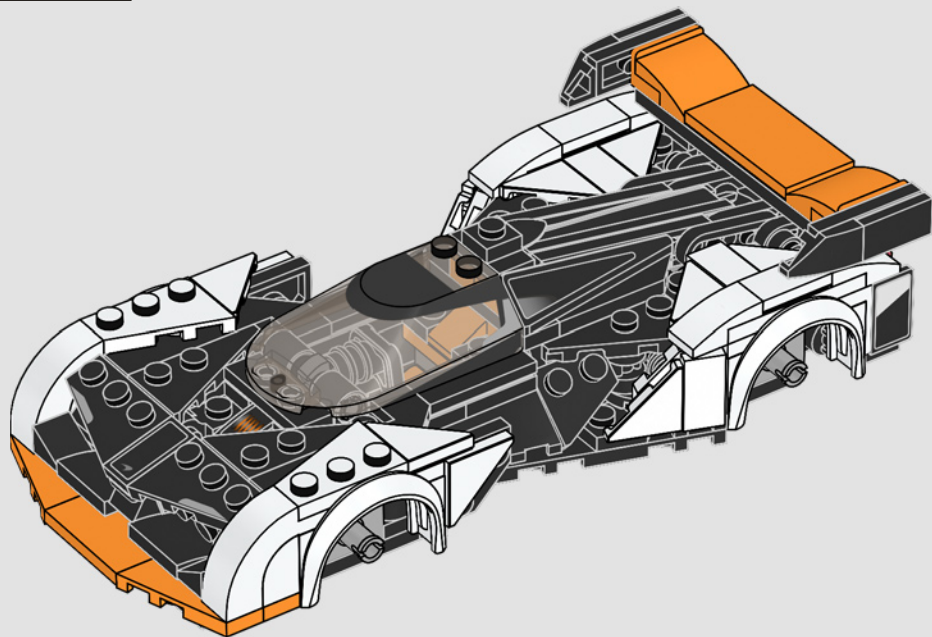





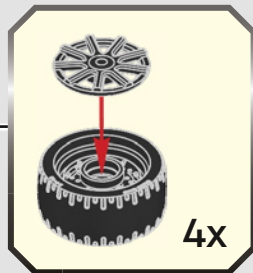
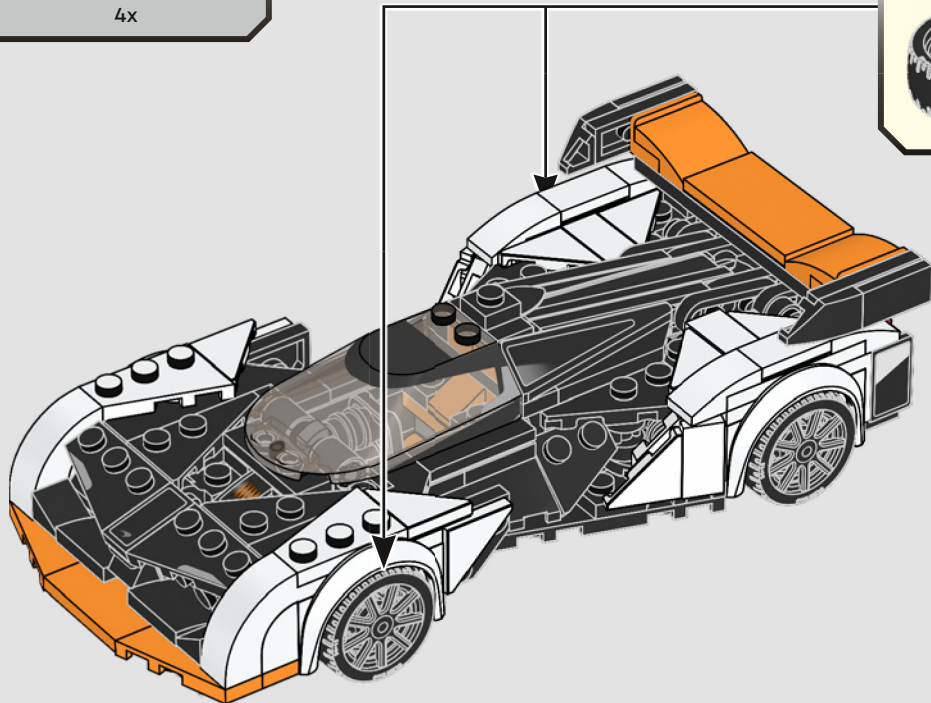

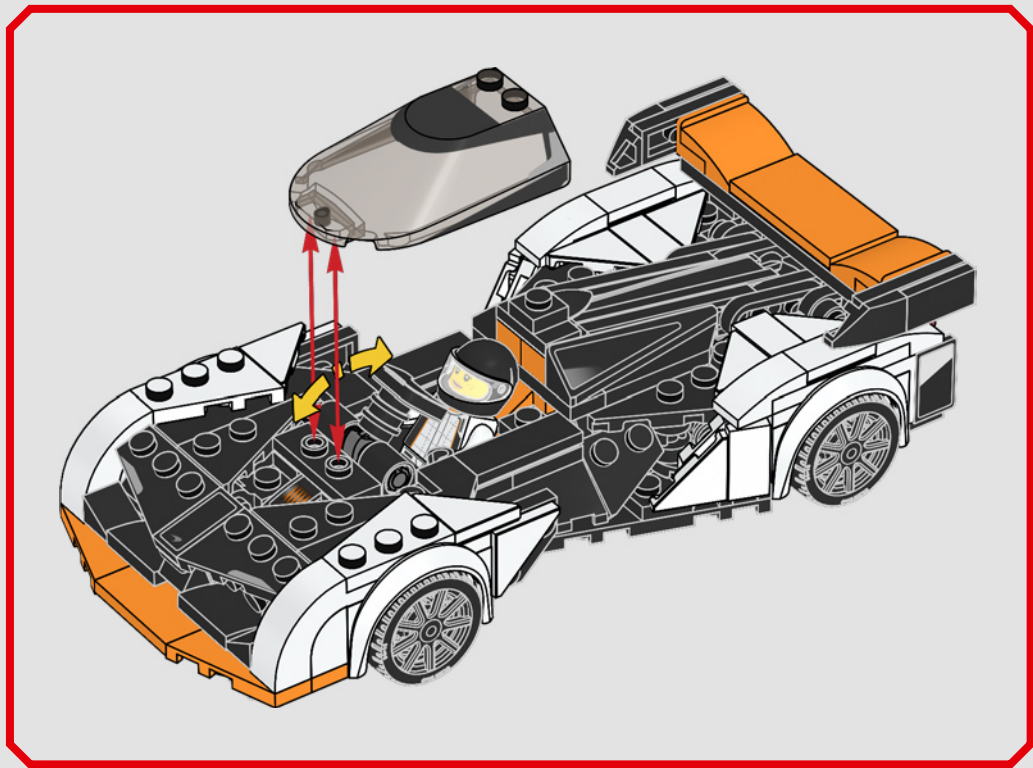

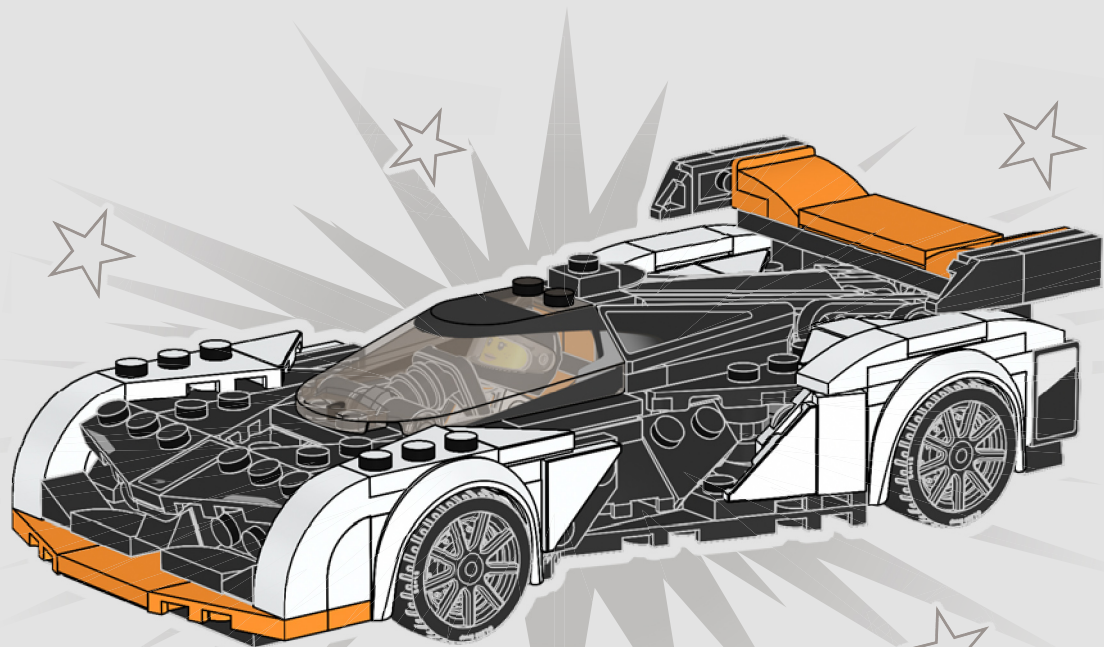



























































122









 2x 6442360	 6x 306901	 1x 6116602	 4x 6271167	 2x 307026	 2x 6104209	 4x 6330189	 2x 6347310
 4x 302401	 4x 6034044	 1x 302101	 1x 6303499	 4x 6335388	 6x 6438919	 2x 4548180	 1x 73081
 3x 6210272	 2x 6176240	 3x 371001	 1x 4651441	 15x 302426	 14x 6210270	 1x 6275175	 4x 3200026
 5x 302301	 10x 6217875	 3x 371001	 1x 6130007	 2x 6388352	 6x 6196548	 2x 6279875	 5x 306926
 2x 6442358	 4x 6061024	 1x 6440844	 1x 6088550	 1x 6181720	 1x 6157554	 2x 6281993	 2x 4121966
 1x 4298609	 4x 6195371	 4x 6438923	 4x 6186675	 1x 6439560	 1x 6141556	 1x 6181713	 1x 6173119
 1x 4179875	 1x 6046979	 6x 4666579	 8x 6168646	 3x 6299338	 2x 6295293	 1x 6438738	 2x 6192309
 1x 4179874	 1x 6440840	 6x 4666579	 6x 6356406	 3x 6234695	 1x 4180508	 1x 6438738	 3x 6146220
 2x 4629913	 1x 6438736	 2x 6384910	 8x 6424674	 1x 4273590	 1x 6141554	 1x 4180536	 1x 6092585
		 1x 6130004	 3x 4106347	 1x 4298619	 2x 6295295	 1x 6438737	 2x 6069000
		 1x 6130004	 9x 4504382	 2x 6003301			

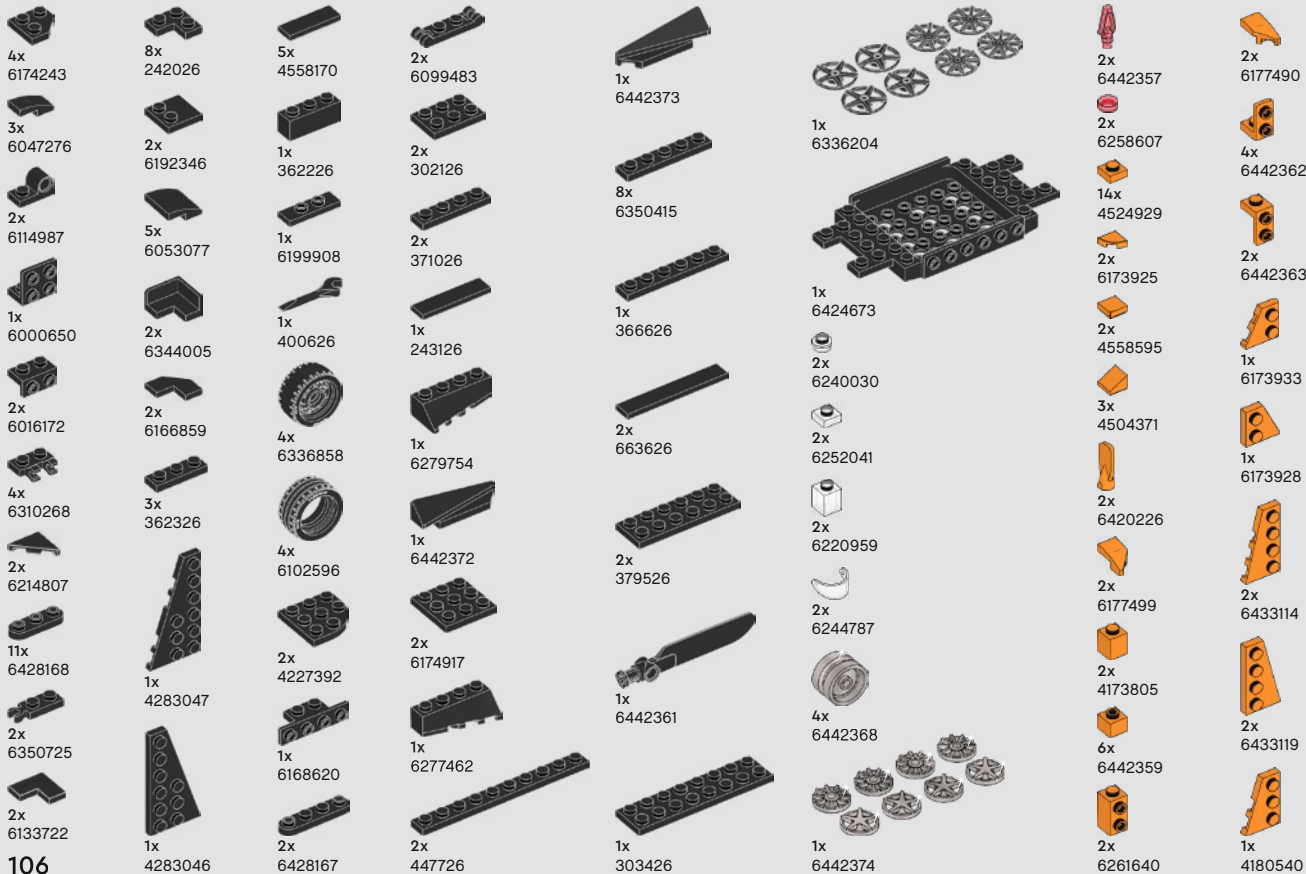



[LEGO.com/service](https://www.LEGO.com/service)



YOU COULD **WIN**



Scan this QR code or go to **LEGO.COM/PRODUCTFEEDBACK** and give us your short feedback about this LEGO® set for a chance to win a cool LEGO prize.

Terms and Conditions apply\*



**DE: Du könntest GEWINNEN.** Es gelten die Teilnahmebedingungen\* **FR: Tu pourrais GAGNER.** Des conditions s'appliquent\* **IT: Potresti VINCERE tu.** Termini e condizioni sono applicabili\* **ES: Puedes GANAR.** Aplican términos y condiciones\* **PT: Poderá GANHAR.** Aplicam-se termos e condições\* **JA: プレゼント付き! 利用規約が適用されます\*** **ZH: 轻松获奖. 条款和条件适用\*** **KO: 상품의 주인이 되어보세요. 소정의 약관이 적용됩니다\*** **RU: Вы можете ВЫИГРАТЬ.** Действуют положения и условия\* **PL: Szansa na WYGRANĄ.** Obowiązują warunki korzystania\* **CS: Máte šanci VYHRÁT.** Platí všeobecné smluvní podmínky\* **SK: Máte šancu VYHRAŤ.** Platia všeobecné zmluvné podmienky\* **HU: TE IS NYERHETSZ.** Felhasználási feltételek érvényesek\* **RO: Ai putea CÂȘTIGA.** Se aplică termeni și condiții\* **BG: Можете да СПЕЧЕЛИТЕ.** Има определени правила и условия\* **LV: Tu vari LAIMĒT.** Ir spēkā noteikumi un nosacījumi.\* **ET: Sul on võimalus VÕITA.** Kehtivad tingimused\* **LT: Jūs galite LAIMĖTI.** Taikomos sąlygos\*  
\*LEGO.com/productfeedback-terms