



# MINECRAFT

21253



LEGO® Builder



### **Get excited about our new packaging!**

We're switching from plastic to paper-based packaging. That's why you might find a mix of paper and plastic in our boxes!

### **Nos nouveaux emballages vous emballeront !**

Nous passons des emballages en plastique aux emballages à base de papier. C'est pourquoi vous pourriez trouver un mélange de papier et de plastique dans nos boîtes !

### **¡Te presentamos nuestros nuevos empaques!**

Estamos sustituyendo las bolsas de plástico por bolsas con base de papel. ¡Por eso, puedes encontrar una mezcla de papel y de plástico en nuestras cajas!

**[LEGO.com/sustainable-packaging](https://www.lego.com/sustainable-packaging)**

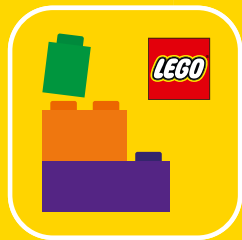

Q LEGO® Builder

# BUILDER



Apple and the Apple logo are trademarks of Apple Inc., registered in the U.S. and other countries and regions. App Store is a service mark of Apple Inc. Google Play and the Google Play logo are trademarks of Google LLC. Tencent and the Tencent logo are trademarks of Tencent Inc.

Q [LEGO.com/devicecheck](https://lego.com/devicecheck)

**EN** Ask parents' permission before going online | **DE** Eltern um Erlaubnis bitten, bevor du online gehst | **FR** Demande l'autorisation d'un parent avant d'aller en ligne | **IT** Chiedi il permesso ai tuoi genitori prima di andare online | **ES** Pídeles permiso a tus papás antes de conectarte a Internet | **PT** Pede autorização aos pais antes de acederes online | **ZH** 上网前应先征得父母的同意 | **PL** Poproś rodziców o zgodę, zanim wejdiesz do Internetu | **CS** Než půjdeš na internet, požádej rodiče o svolení | **SK** Skôr než pôjdeš na internet, vypýtaj si povolenie od rodičov | **HU** Kérj szülői engedélyt, mielőtt online csatlakoznál! | **RO** Cere permisiunea părinților înainte de a te conecta online | **BG** Поискайте разрешение от родител, преди да влезете онлайн | **LV** Pirms došanās tiešsaistē palūdz atļauju vecākiem | **ET** Enne Interneti kasutamist küsi vanematelt luba | **LT** Prieš prisijungdami prie interneto, atsiklauskite tėvų

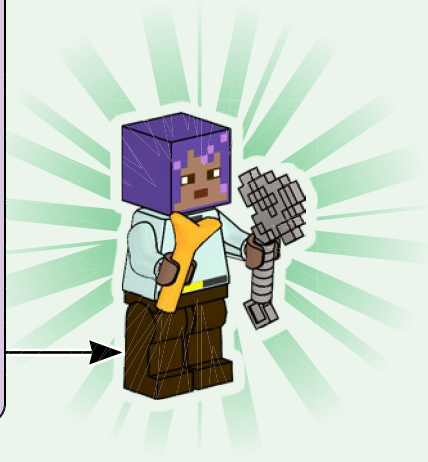
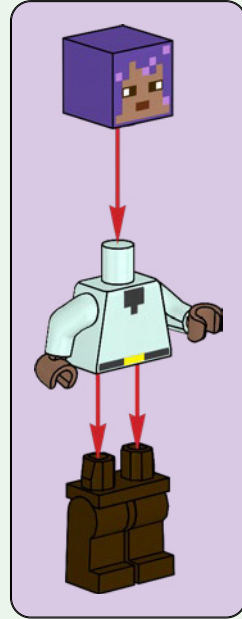

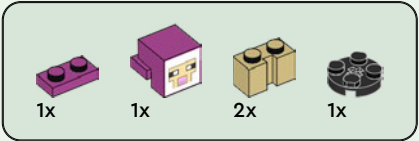

1



2

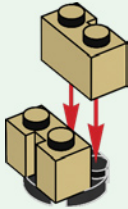

3



4

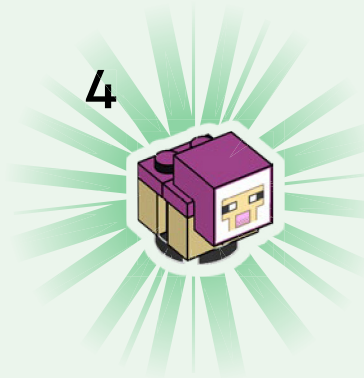

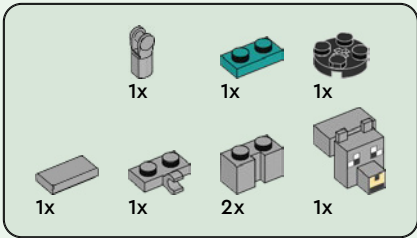
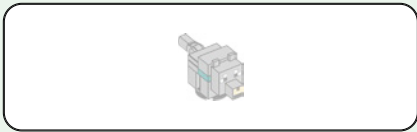

1



2

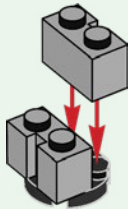

3

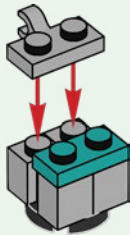

4

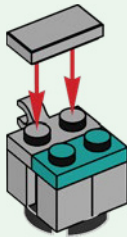

5

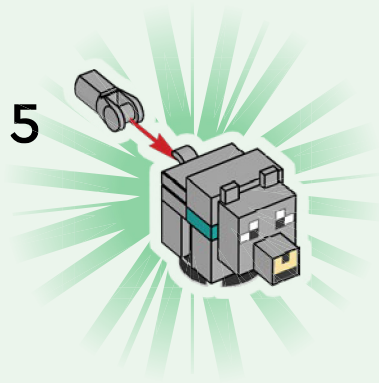

6

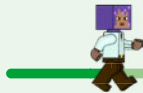

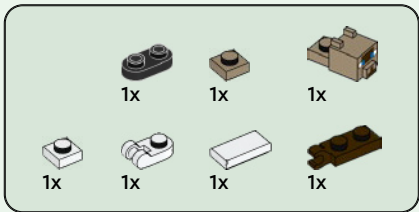

1



2

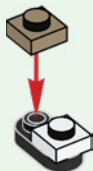

3



4

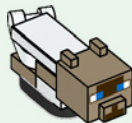

5

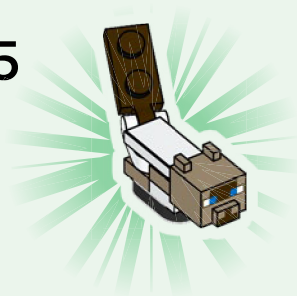

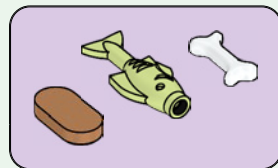
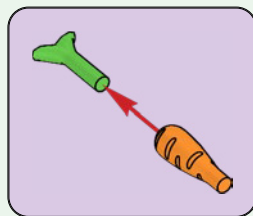
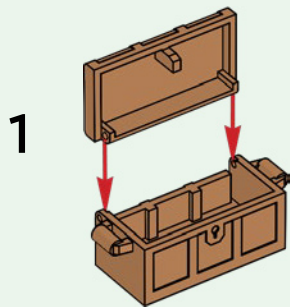
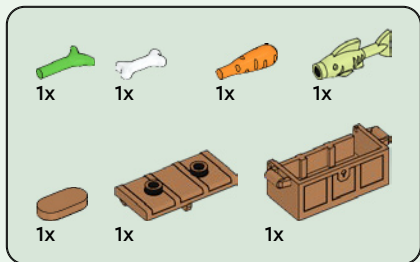

2

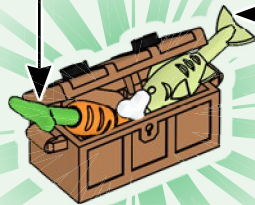





2x



2x



2x



2x



2x

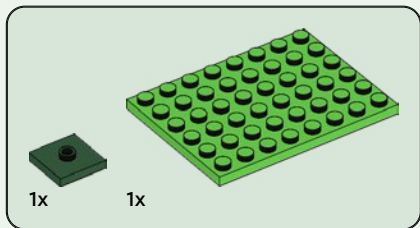
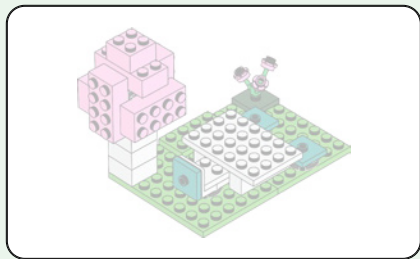

1

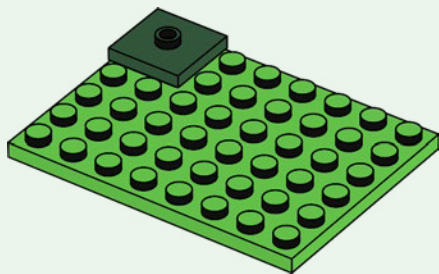

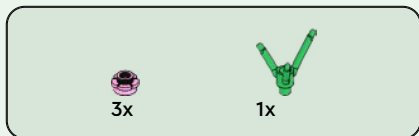

2

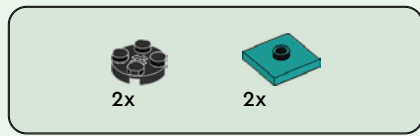
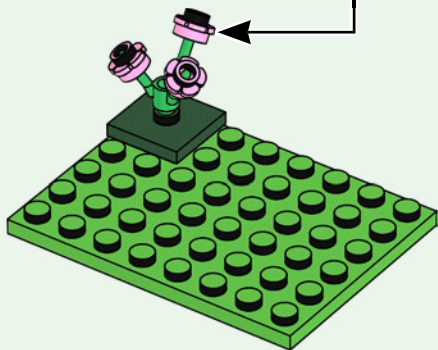
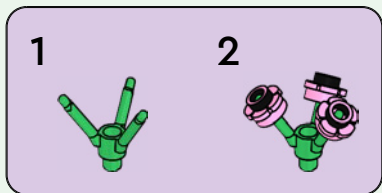

3

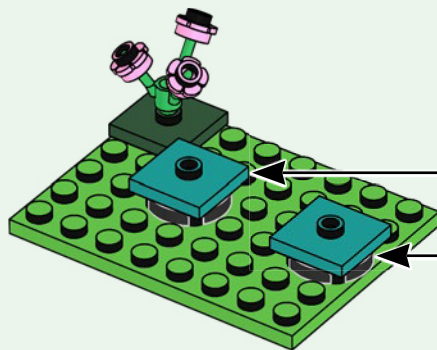
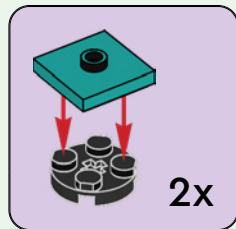

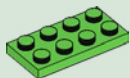

1x

4

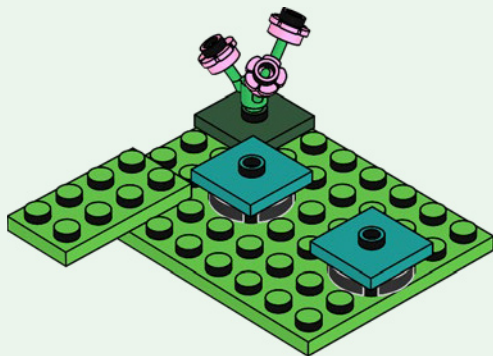

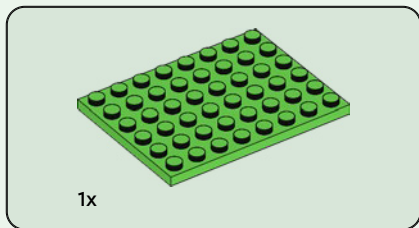

5

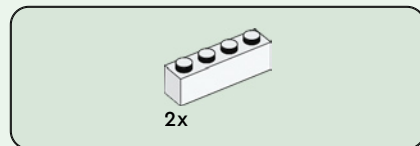
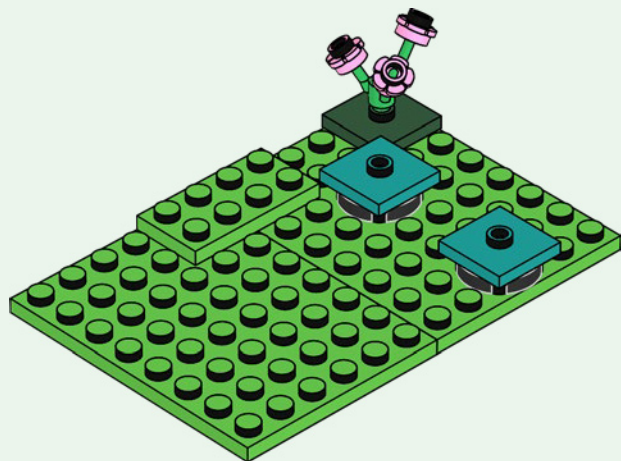

6

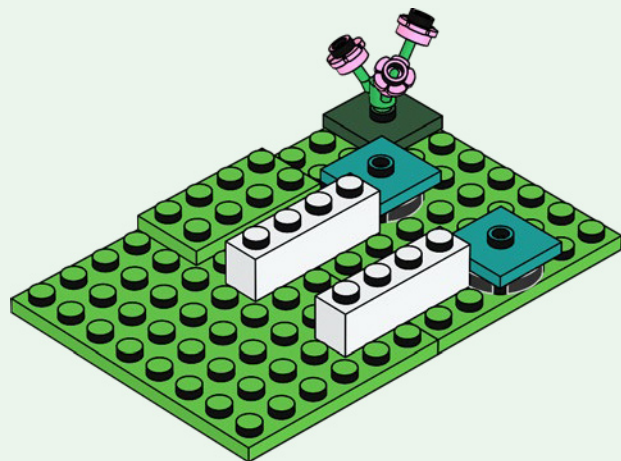

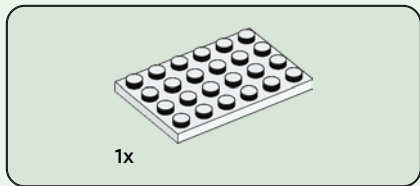

7

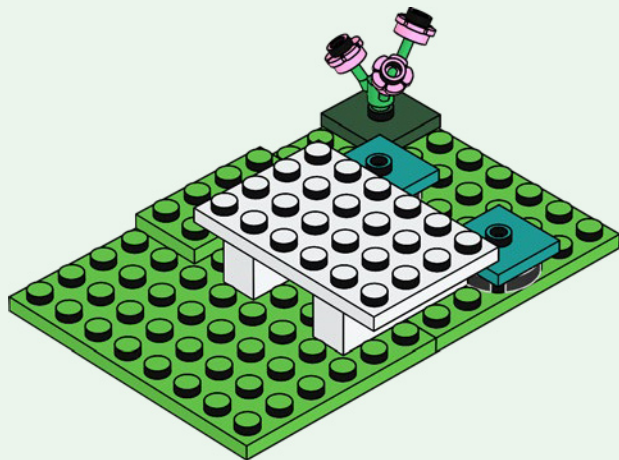

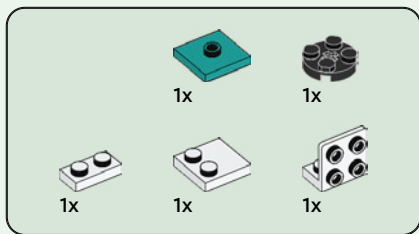

# 8

1



2



3

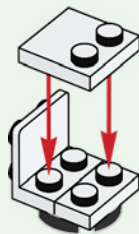

4

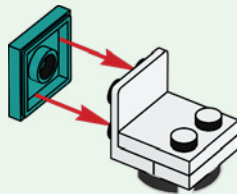

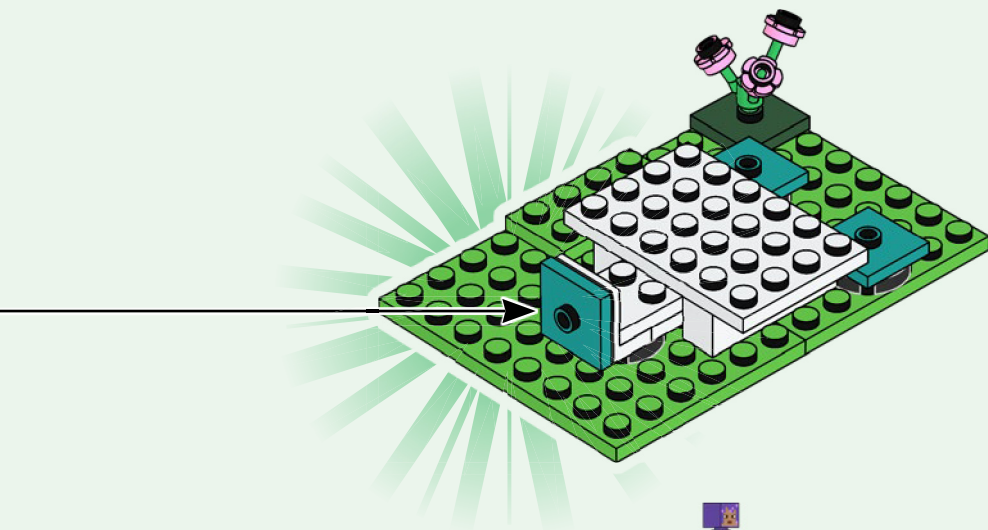



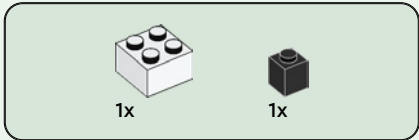
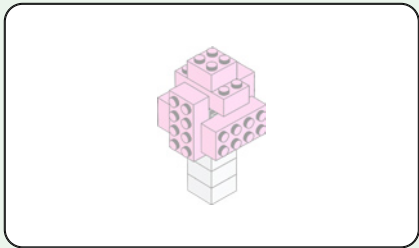

9

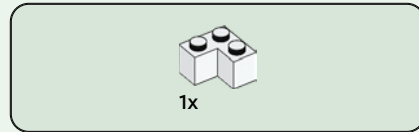
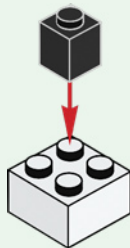

10

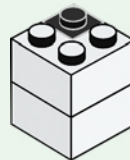



3x

11

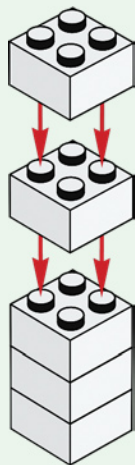

2x

12

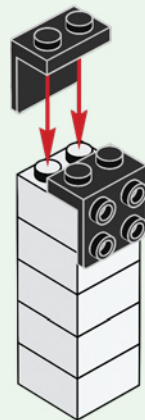



2x

13

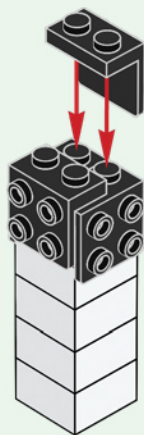

2x

14

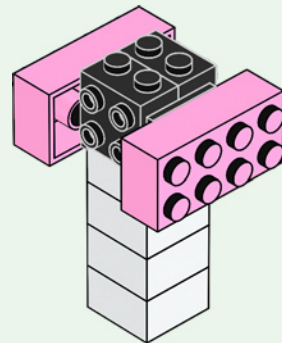

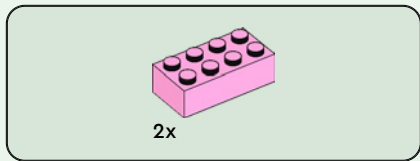

15

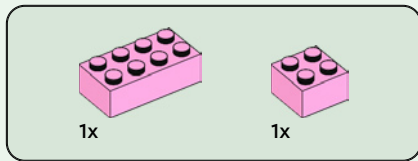
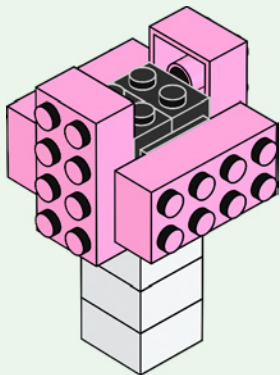

16

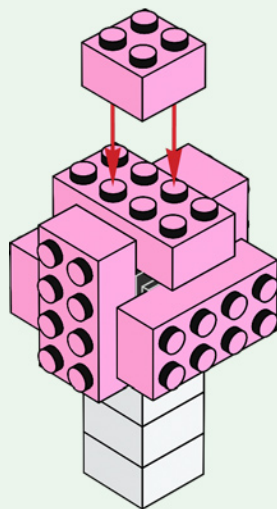

17

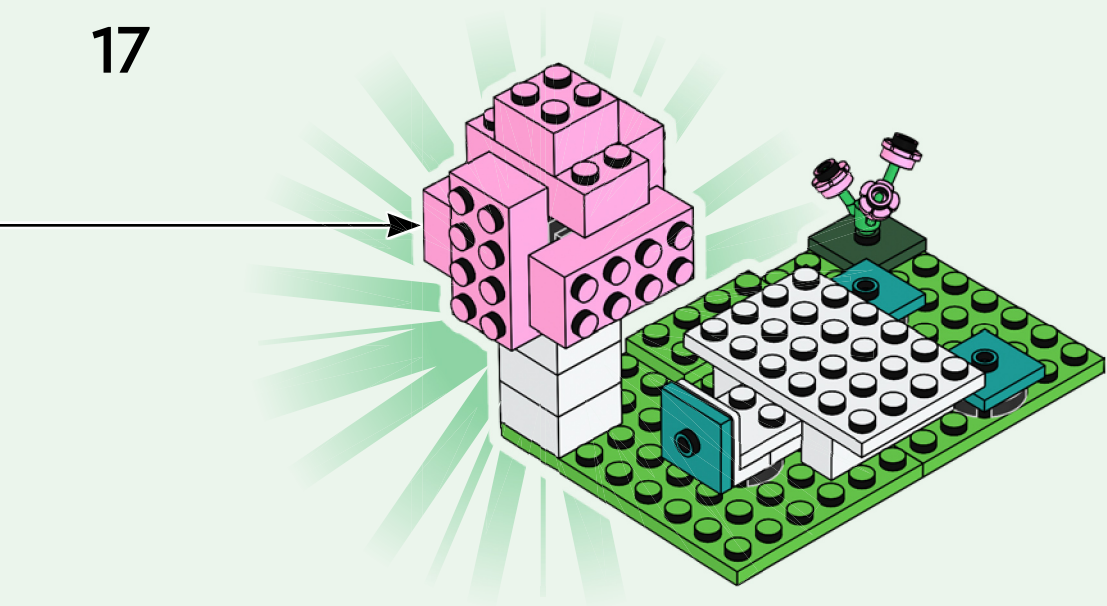

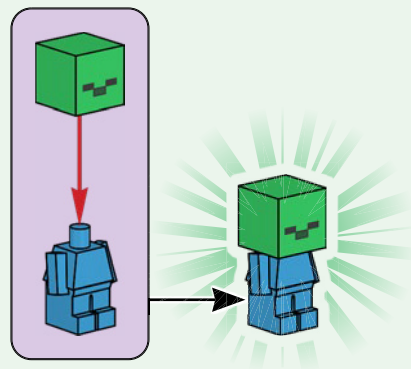



1x



1x



2x



1x



1x

1



2

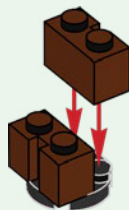

3

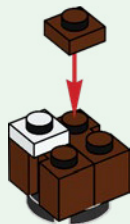

4





1x



1x



1x



1x

1



2



3

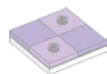

1x



2x



2x

1

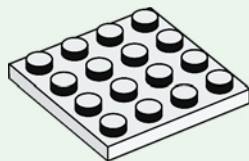

2

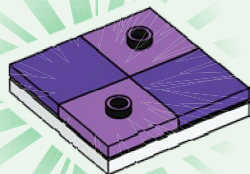



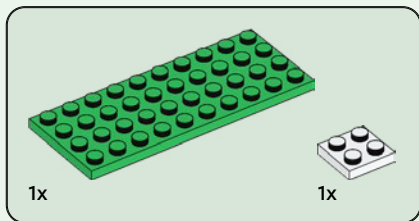
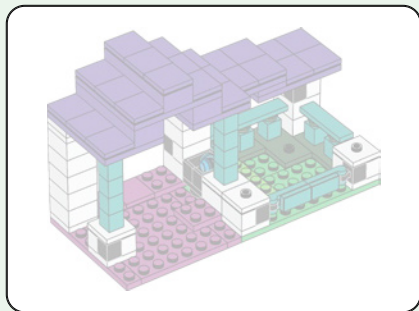

18

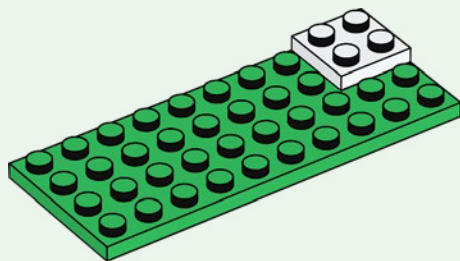



2x

19

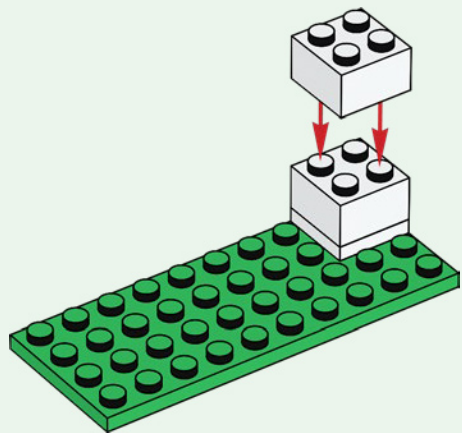

1x

20

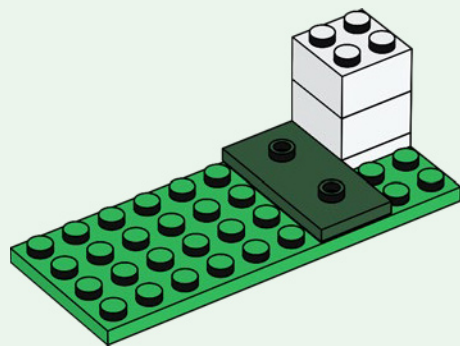

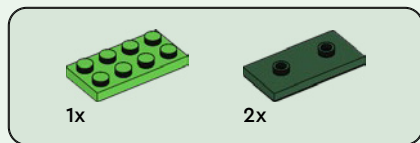

21

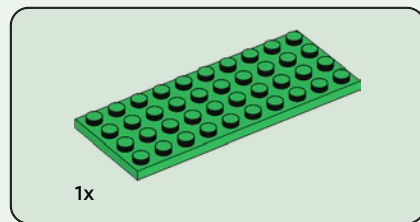
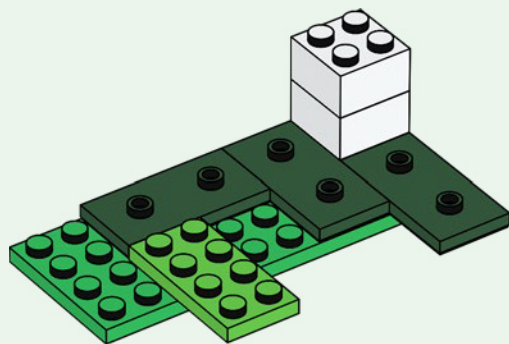

22

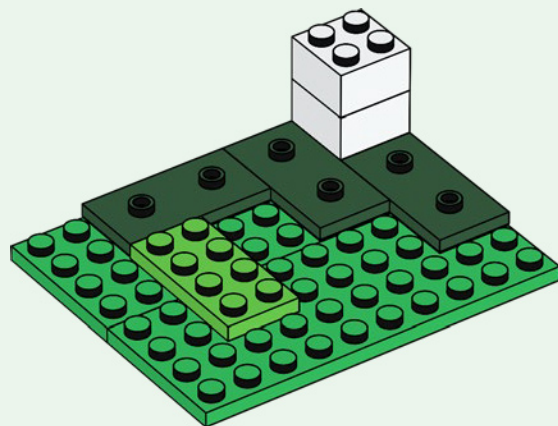



5x



5x

# 23



5x

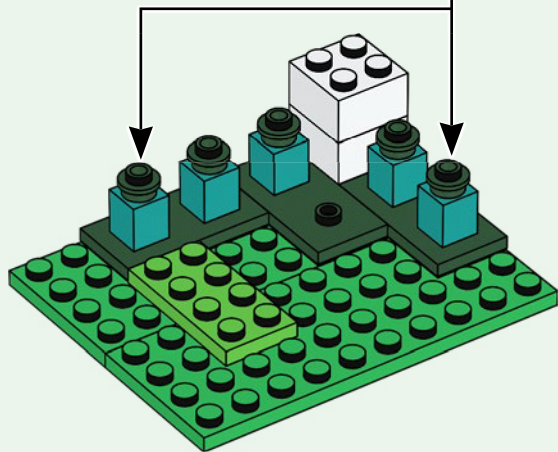

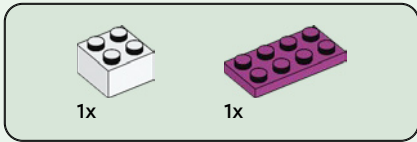

24

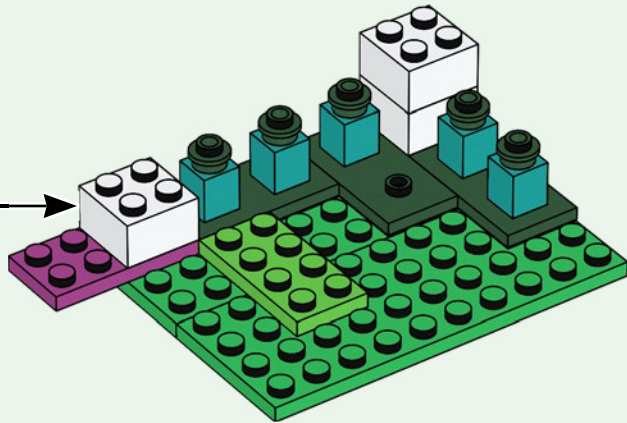
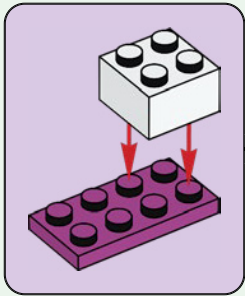

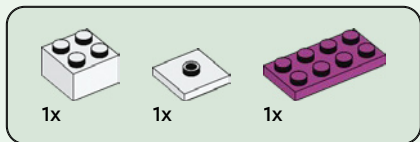

25

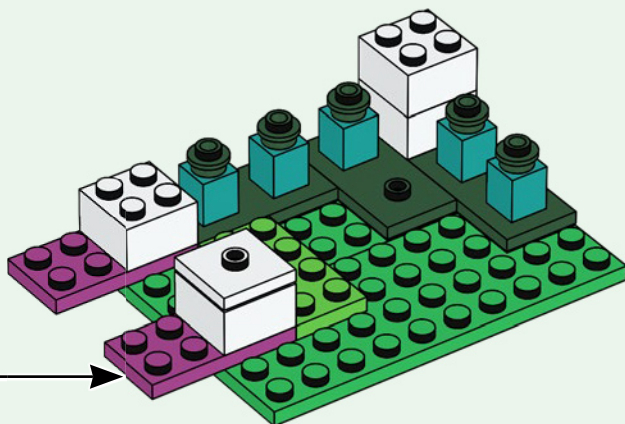
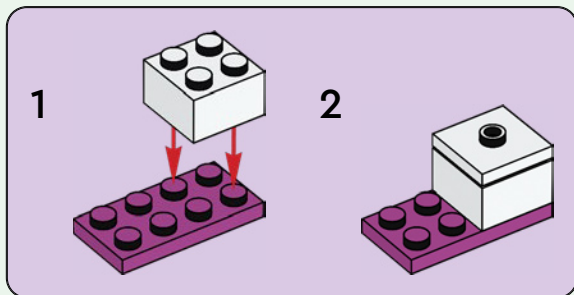

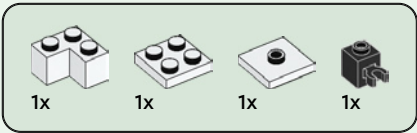

26

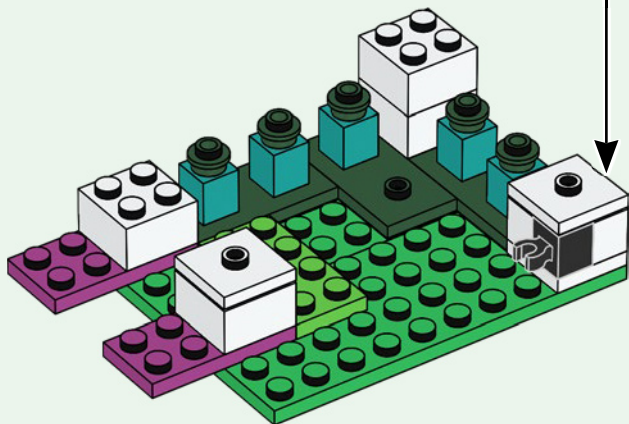
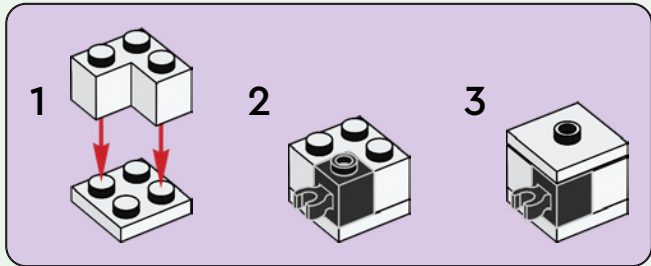

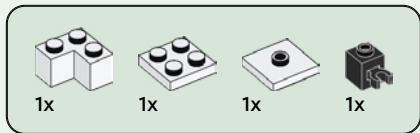

27

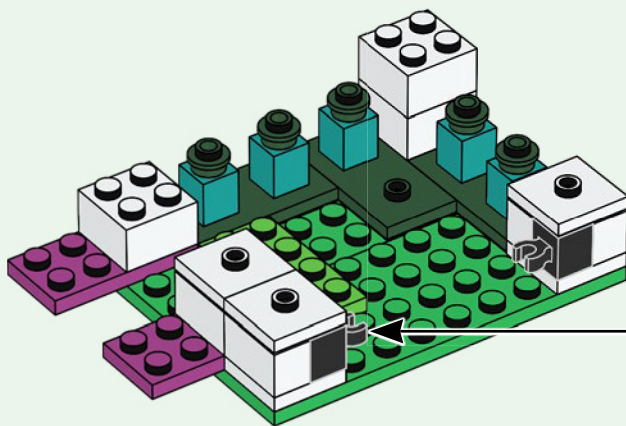
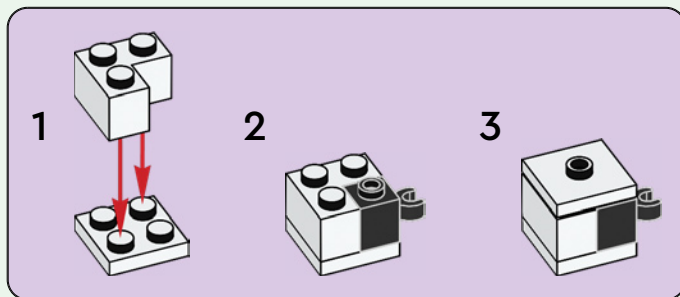







2x



1x



1x



2x

# 29

1

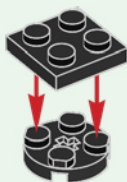

2

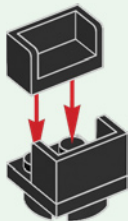

3

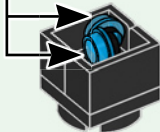

2x

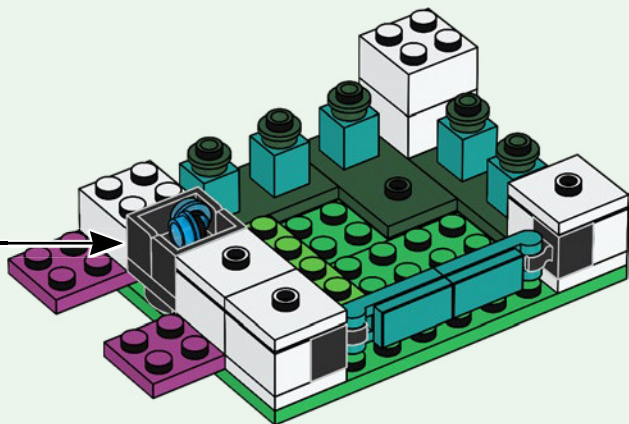

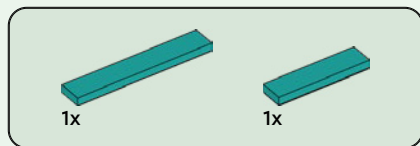

30

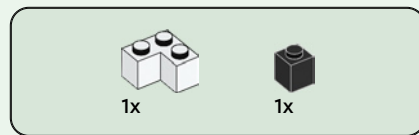
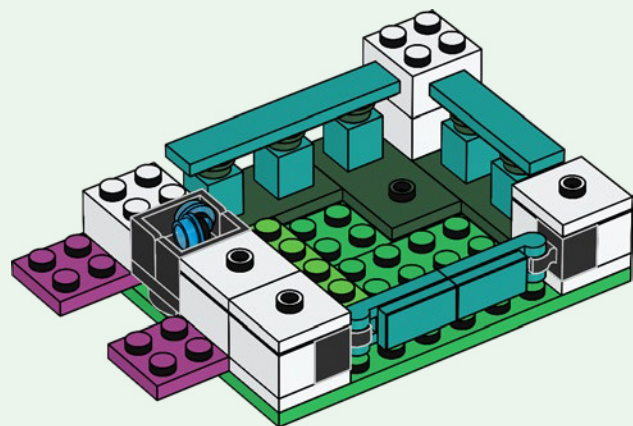

31

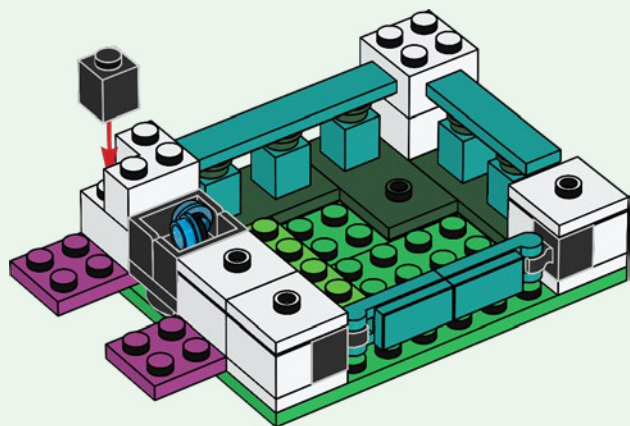



1x



1x

# 32

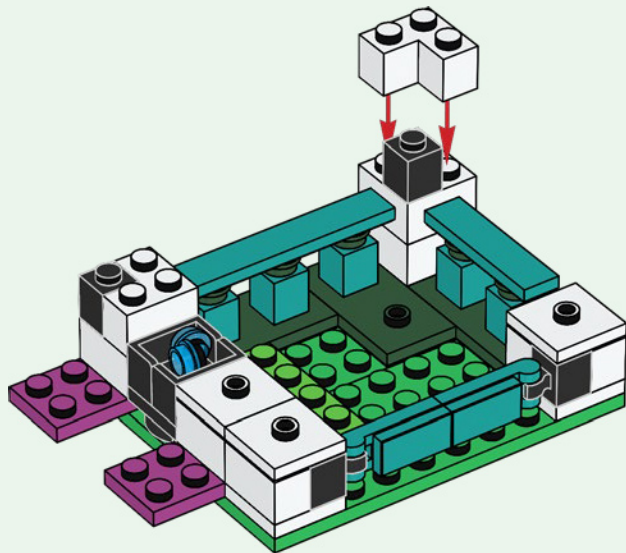



1x

# 33

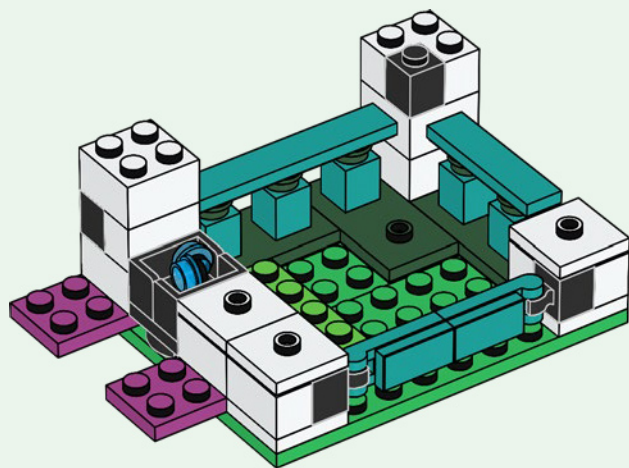

2x

# 34

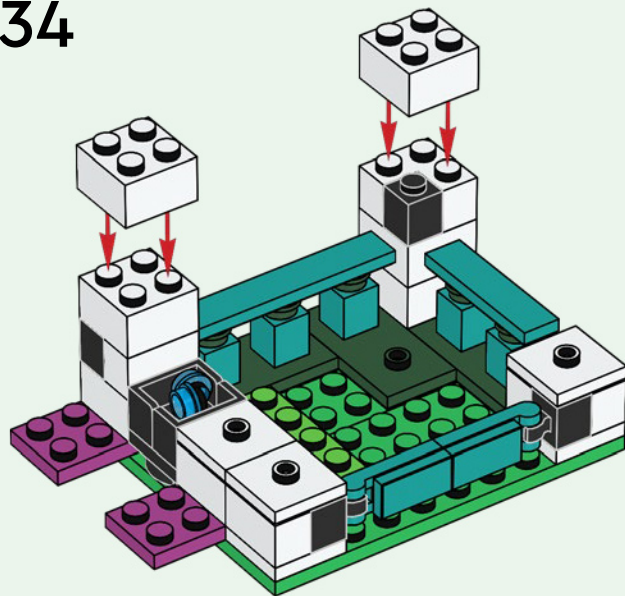

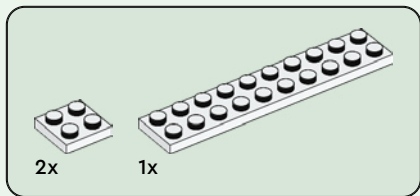

35

1

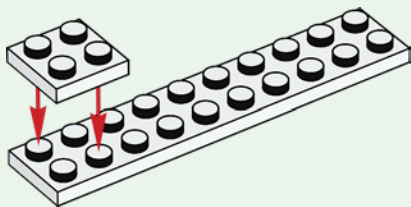

2

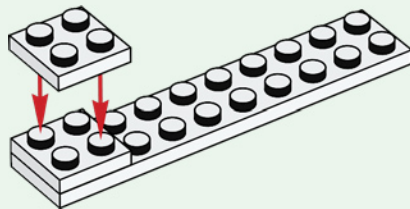

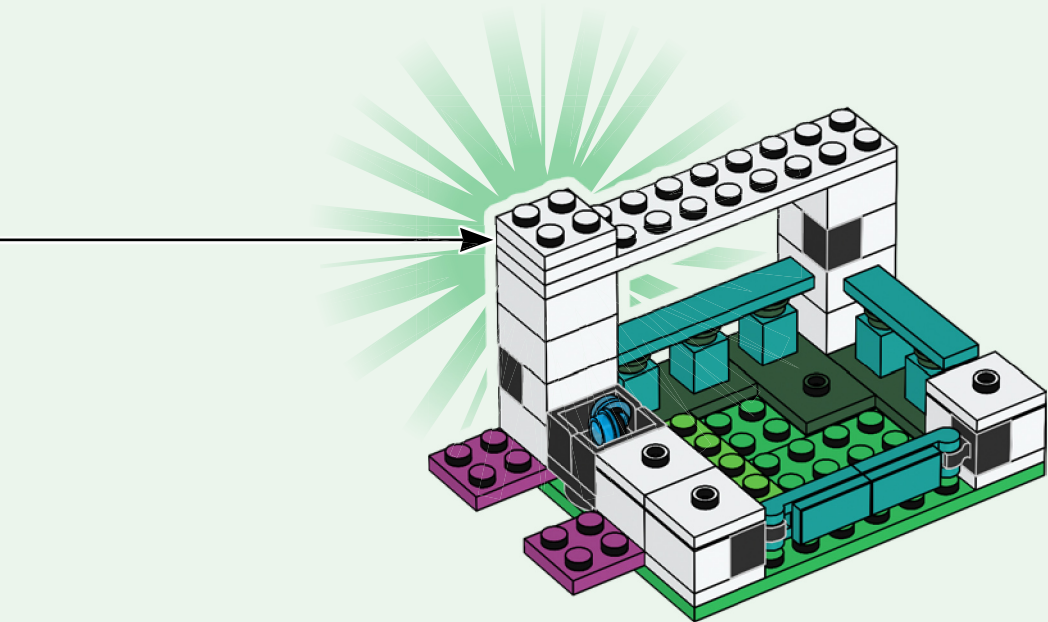

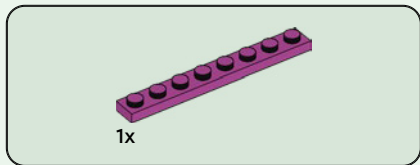

36

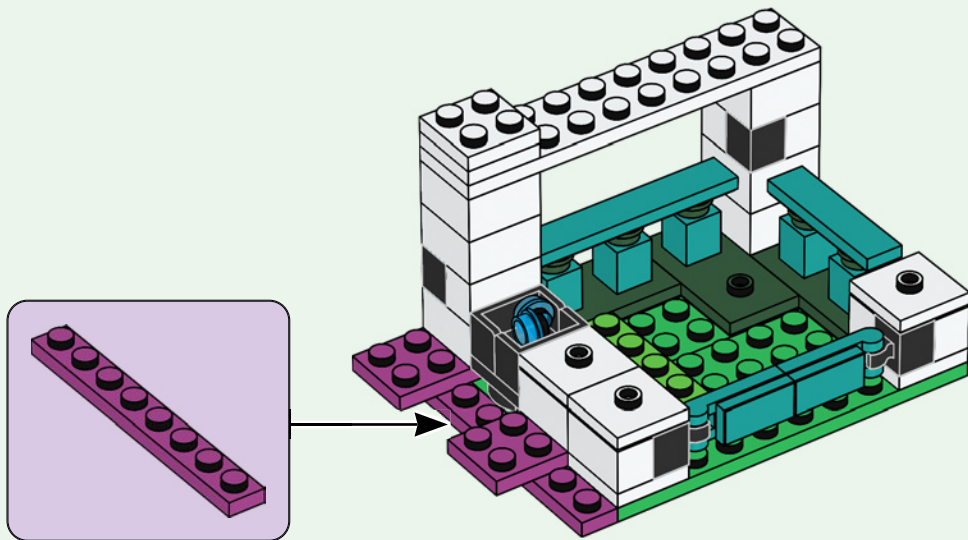



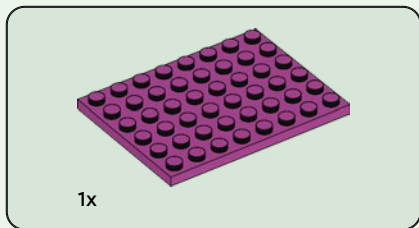

37

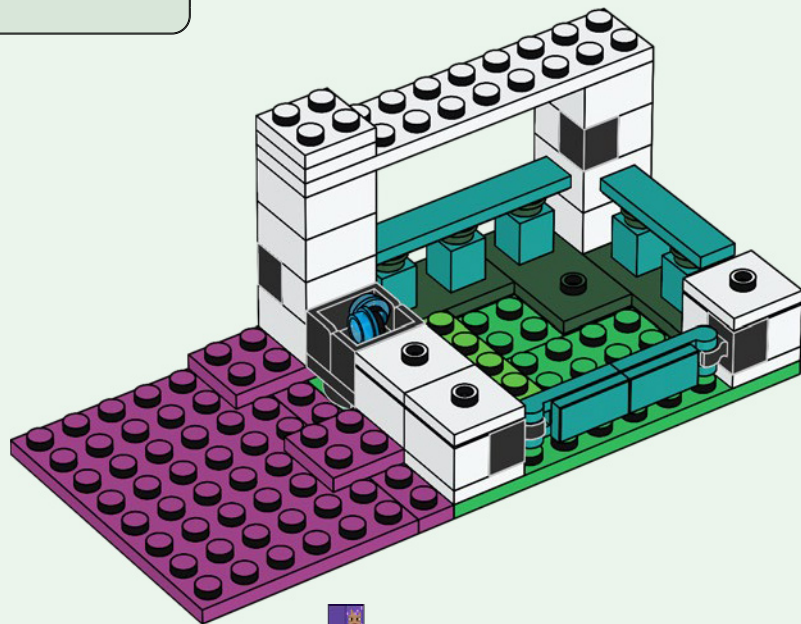



1x



2x

38

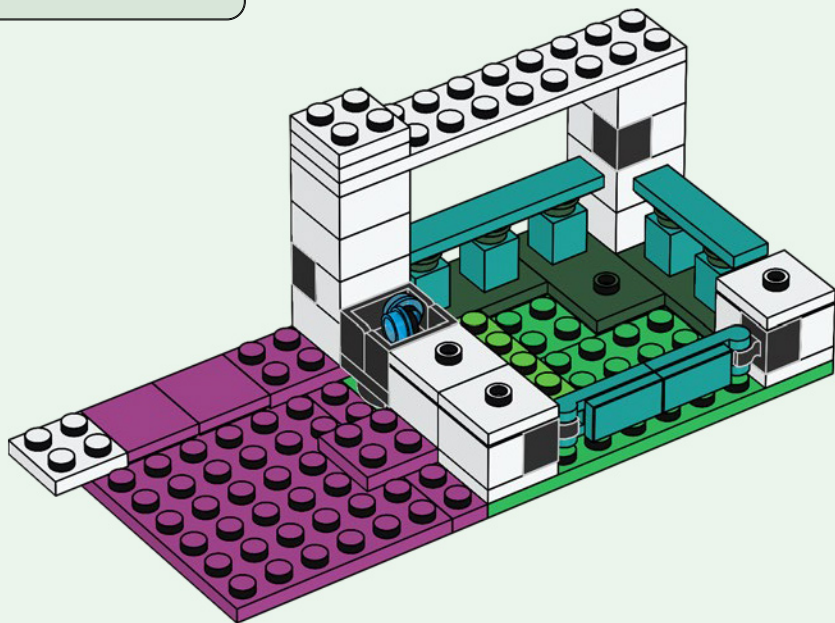

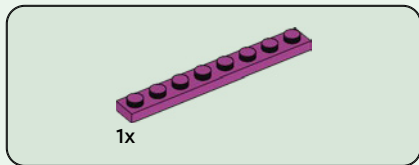

39

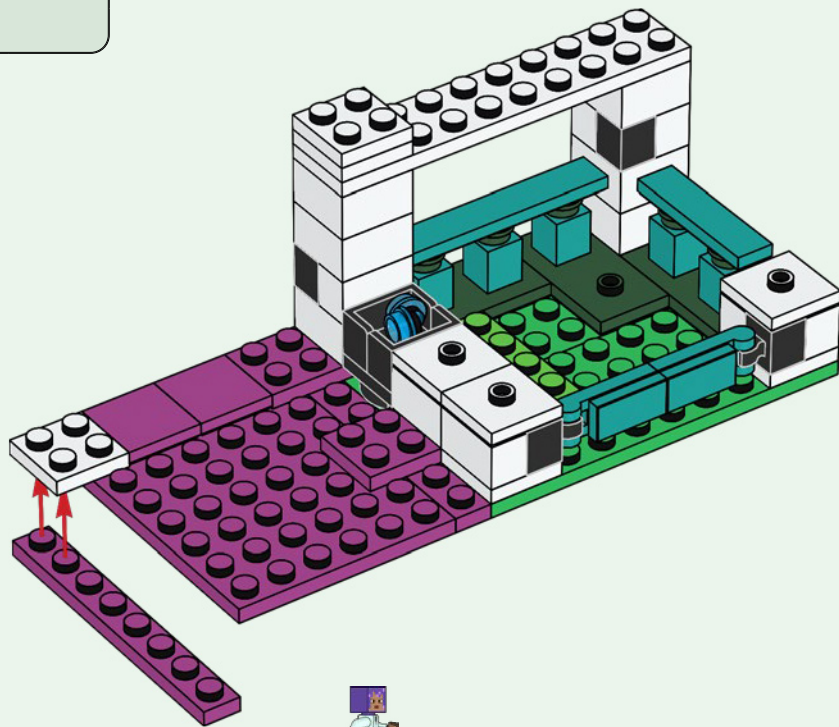

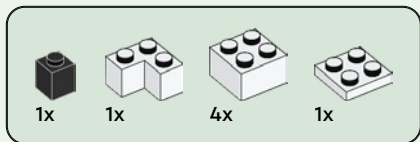

40

1

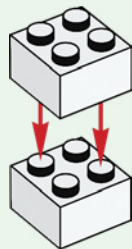

2

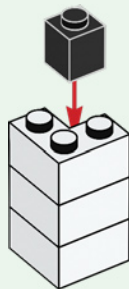

3

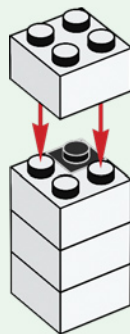

4

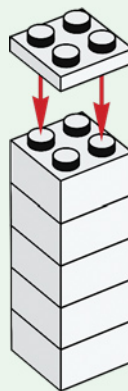

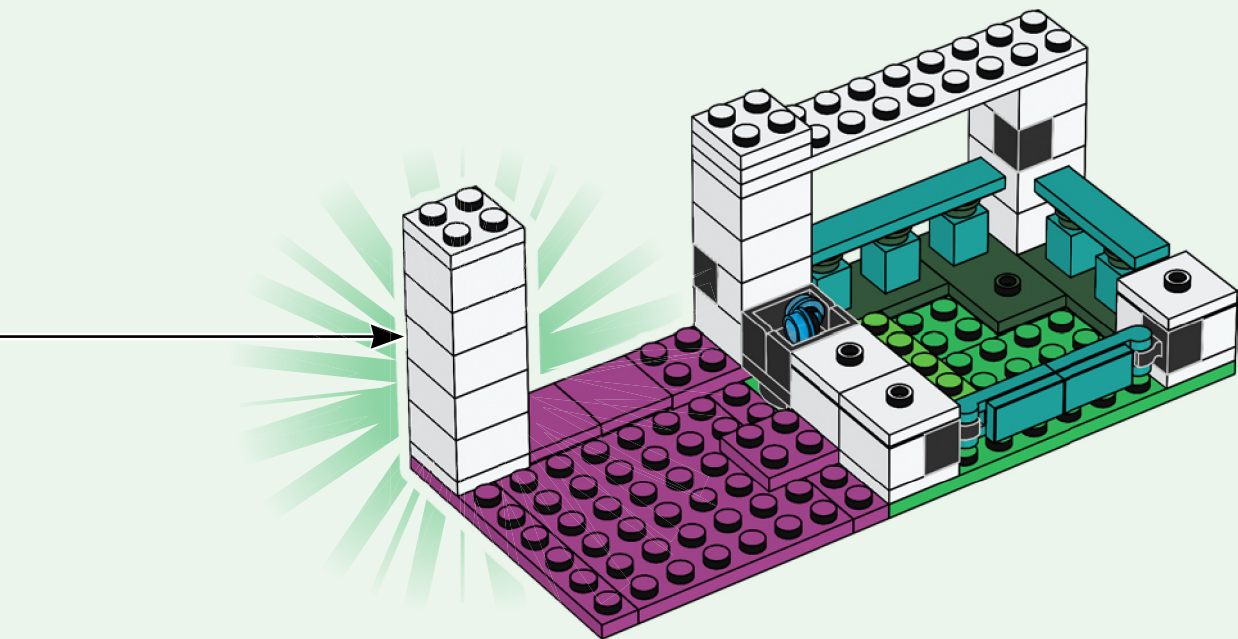

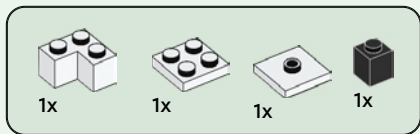

41

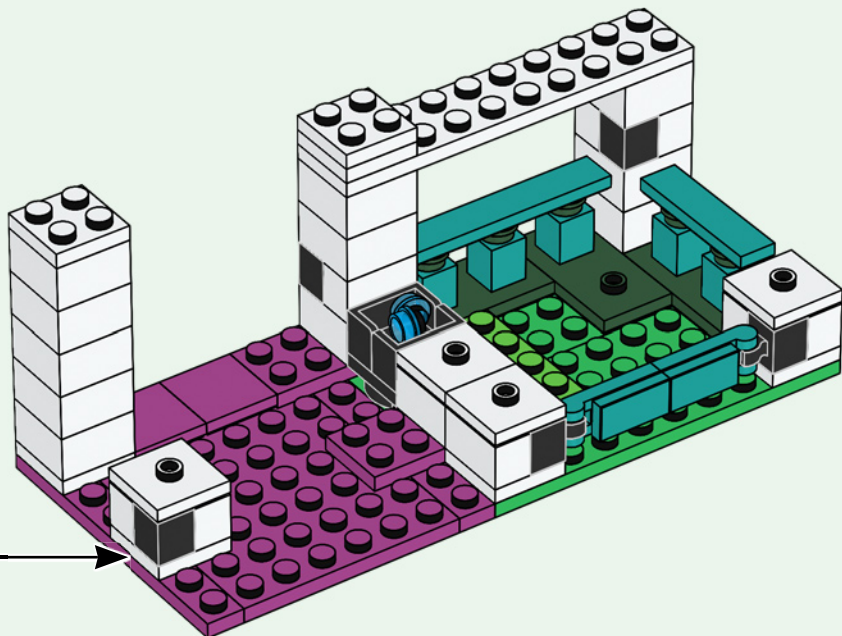
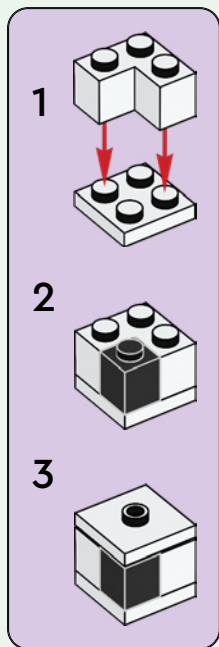

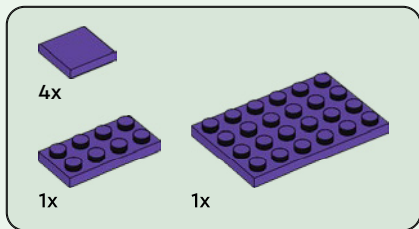

42

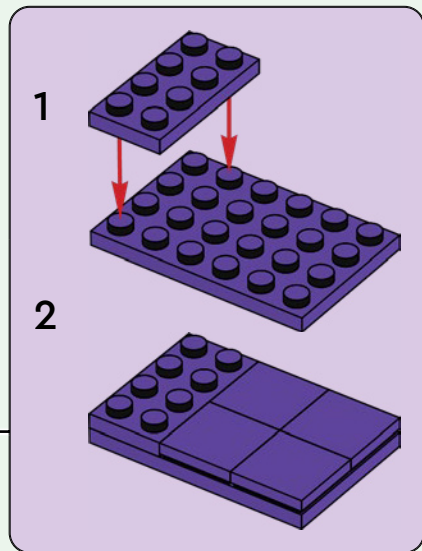
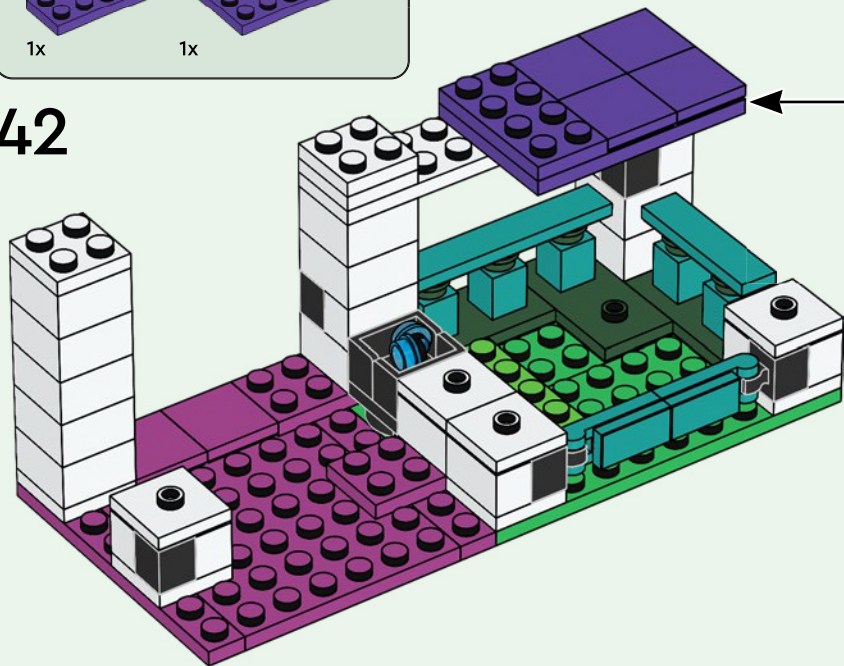

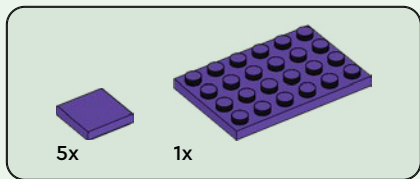

43

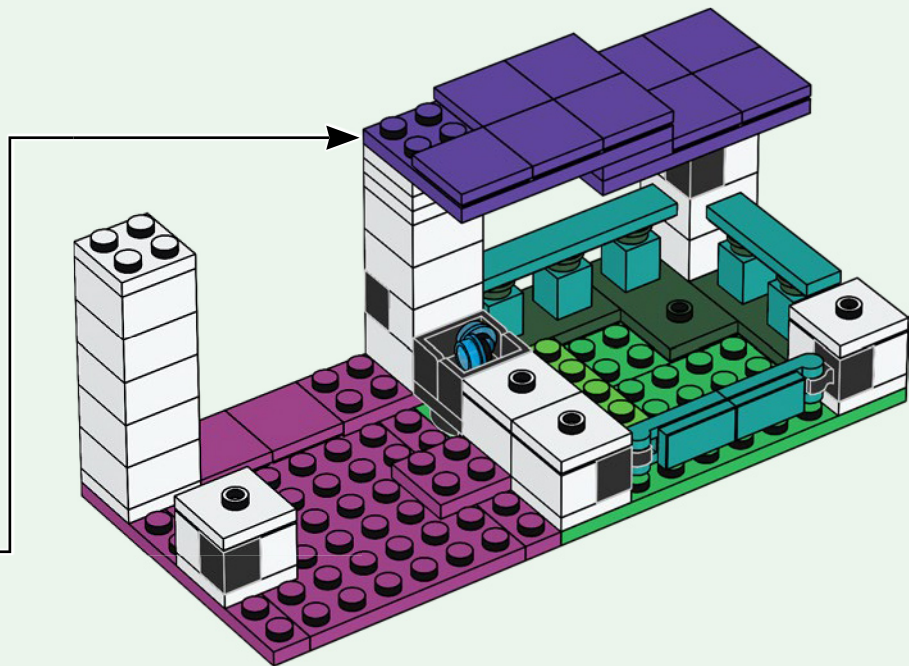
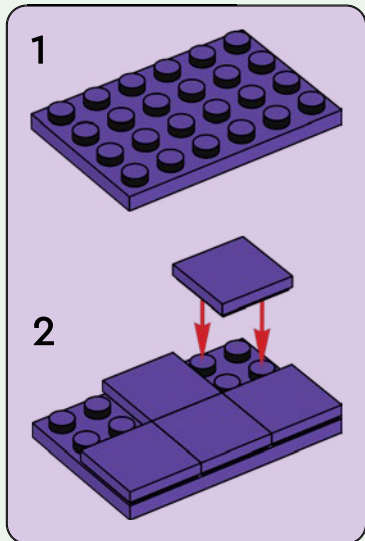



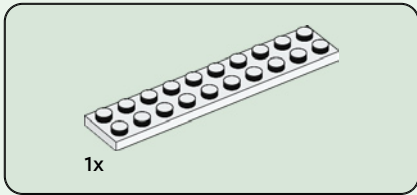

44

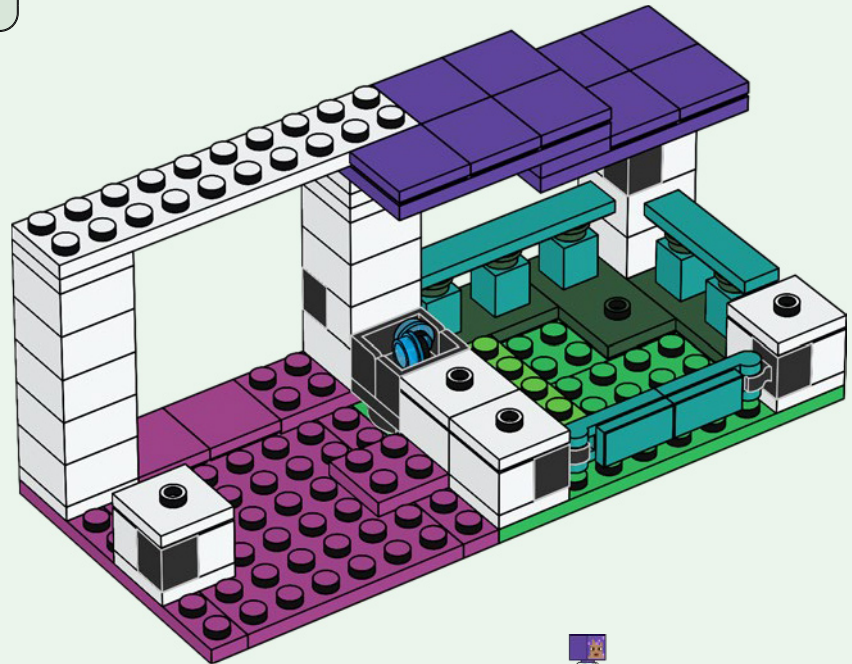



8x



2x

# 45

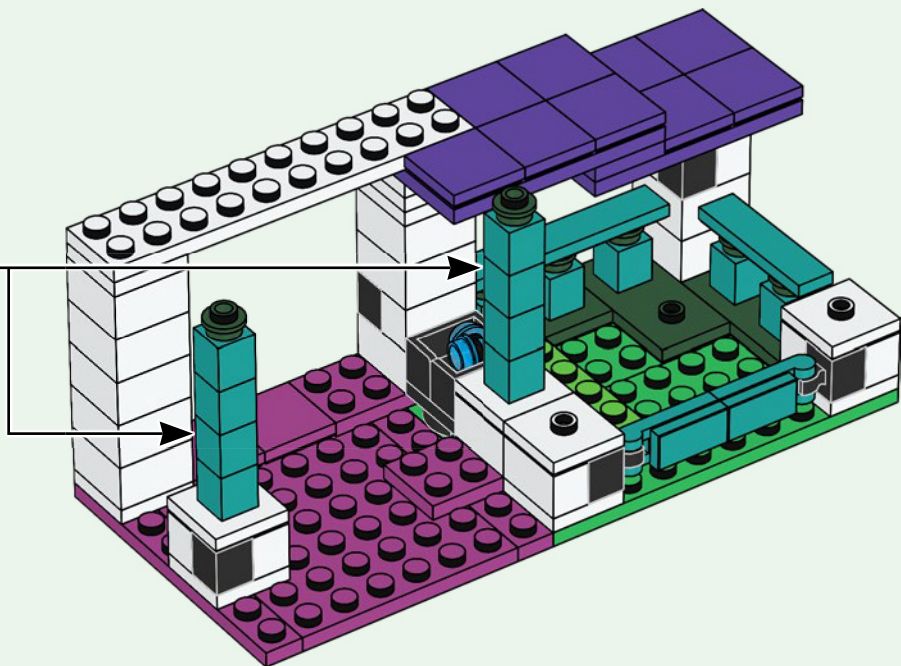
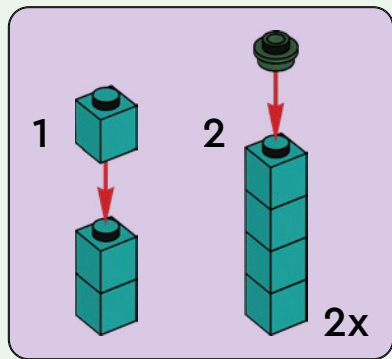

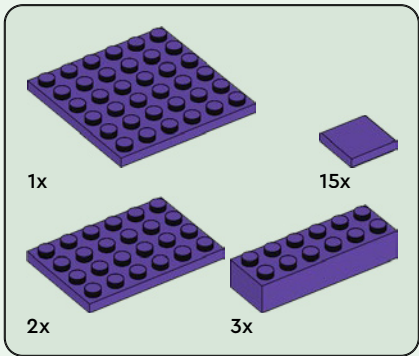

46

1

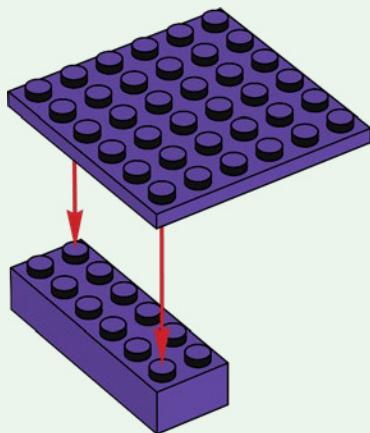

2

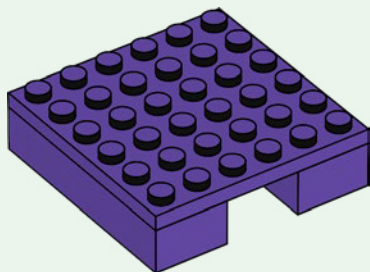

3

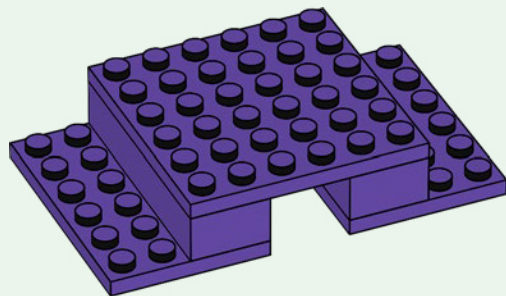

4

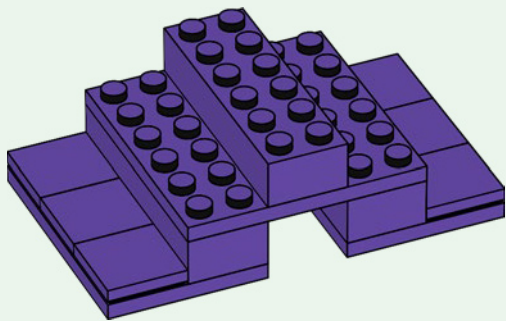

5

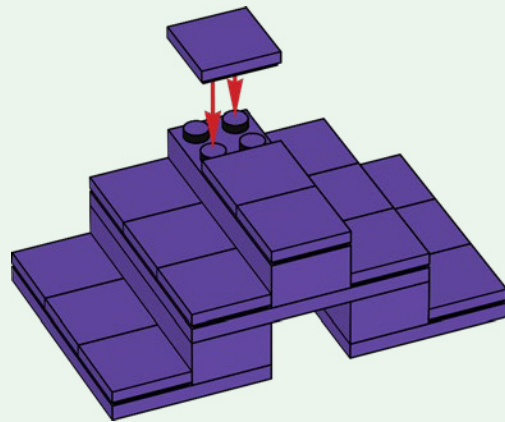

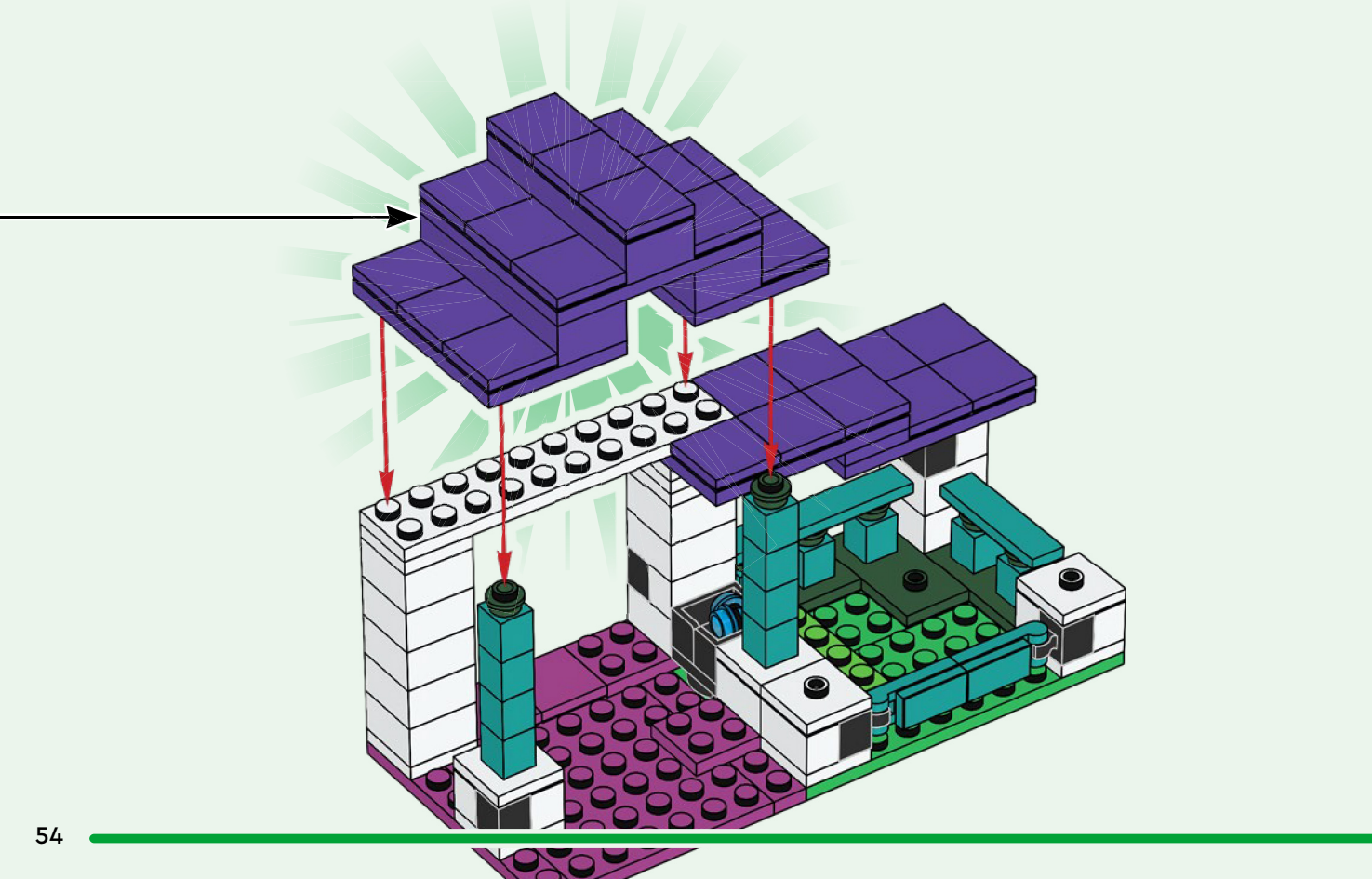

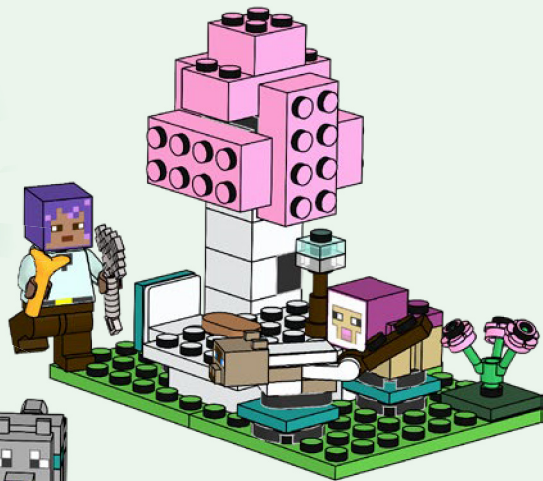
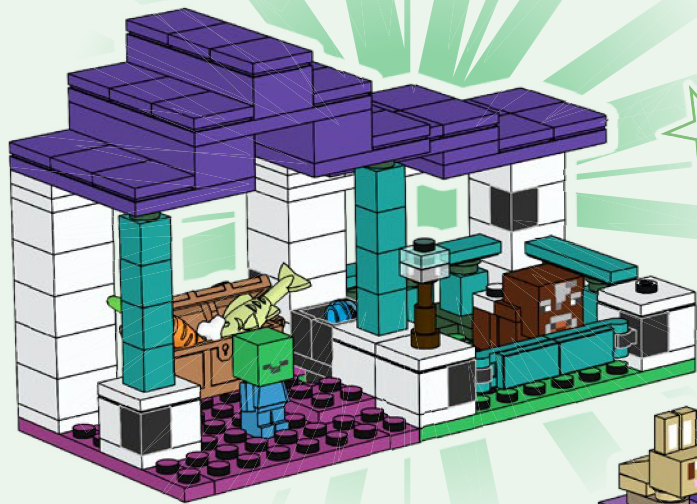



# MINECRAFT

21256



21257



21251





21255



21252



21253



21254



# MINECRAFT

Combine sets to expand your play!

Combiner les ensembles pour  
encore plus de jeu !

¡Combina sets para jugar  
mucho más!

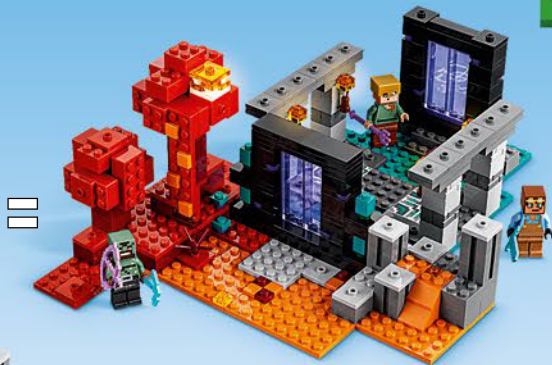
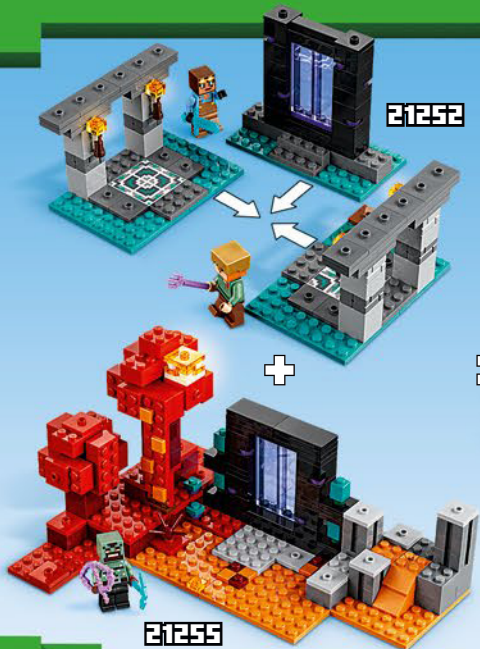



+



21254

=





Rebuild  
the  
world™





Rebuild  
the  
world™





2x  
302401



1x  
6360202



1x  
6174937



1x  
302301



1x  
306901



1x  
6097637



1x  
6218822



8x  
302201



15x  
300301



7x  
235701

62



4x  
6126046



2x  
301001



1x  
4243812



1x  
303201

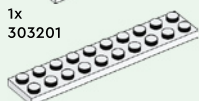

2x  
383201



1x  
4161734



1x  
4159553



2x  
6103001



1x  
6468465



5x  
300526



2x  
6336977



1x  
6210270



7x  
403226



2x  
6248496



4x  
6117973



1x  
302226



1x  
6331398



1x  
6269971



1x  
4119479



2x  
6141590

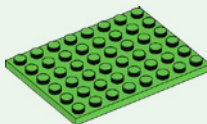

2x  
6340684

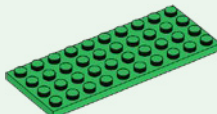

2x  
6398657



13x  
6213776



1x  
6213777



2x  
6213779



3x  
6290269



2x  
6295286



1x  
6292786



1x  
6264986



1x  
6424015



1x  
6103415



2x  
6249234



1x  
6468464



2x  
6037658



2x  
6109929



1x  
6441042



1x  
4549436



1x  
6231386



1x  
6468466



7x  
6230571



1x  
6186827



3x  
6383324



1x  
4221744



2x  
6103004



1x  
6468468



1x  
6343976



2x  
4617170



1x  
6313114



1x  
4211414



1x  
6468467



3x  
6212501



1x  
4550359



5x  
4520632



26x  
6057386



1x  
6468469



1x  
6030277



3x  
6147004



4x  
6147032



1x  
6426669



2x  
6252043



2x  
6252041



2x  
6240214



1x  
6291414



1x  
4529672



2x  
4538950



1x  
6347286



1x  
6096682



1x  
6399909



1x  
6394960



1x  
6102984



1x  
6089099



1x  
6397838



1x  
6470358



2x  
6177195



 [LEGO.com/service](https://www.LEGO.com/service)

YOU COULD  
**WIN**

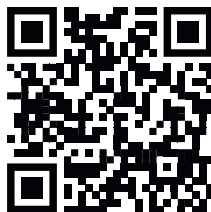

Scan this QR code or go to  
**LEGO.COM/PRODUCTFEEDBACK** and give  
us your short feedback about this LEGO® set  
for a chance to win a cool LEGO prize.

Terms and Conditions apply\*

**EN: YOU COULD WIN.** Terms and Conditions apply\* **DE: Du könntest GEWINNEN.** Es gelten die Teilnahmebedingungen\* **FR: Tu pourrais GAGNER.** Des conditions s'appliquent\* **IT: Potresti VINCERE tu.** Termini e condizioni sono applicabili\* **ES: Puedes GANAR.** Aplican términos y condiciones\* **PT: Poderá GANHAR.** Aplicam-se termos e condições\* **ZH: 轻松获奖. 条款和条件适用\*** **PL: Szansa na WYGRANĄ.** Obowiązują warunki korzystania\* **CS: Máte šanci VYHRÁT.** Platí všeobecné smluvní podmínky\* **SK: Máte šancu VYHRAŤ.** Platia všeobecné zmluvné podmienky\* **HU: TE IS NYERHETSZ.** Felhasználási feltételek érvényesek\* **RO: Ai putea CÂȘTIGA.** Se aplică termenii și condiții\* **BG: Можете да СПЕЧЕЛИТЕ.** Има определени правила и условия\* **LV: Tu vari LAIMĒT.** Ir spēkā noteikumi un nosacījumi.\* **ET: Sul on võimalus VÕITA.** Kehtivad tingimused\* **LT: Jūs galite LAIMĖTI.** Taikomos sąlygos\*

\*[LEGO.com/productfeedback/terms](https://www.lego.com/productfeedback/terms)

LEGO and the LEGO logo are trademarks of the/son des marques de commerce du/son marcas registradas de LEGO Group. ©2024 The LEGO Group.  
© 2024 Mojang AB. All Rights Reserved. Minecraft, the Minecraft logo, the Mojang Studios logo and the Creeper logo are trademarks of the Microsoft group of companies.

6495805