

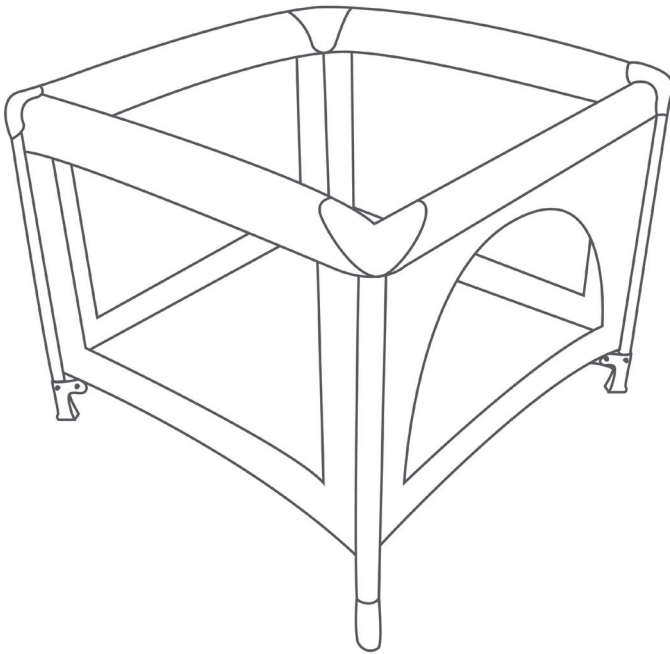

## TRAVEL COT

*Enjoy*



\* The illustration in the manual are only indicative and design may differ from the product you purchased

**INSTRUCTION FOR USE**

## PART LIST

**EN:** Unpack all the parts, and make sure that all parts are there:  
A. Crib      B. Mattress      C. Travel bag

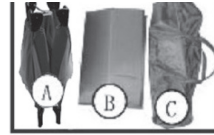

## ASSEMBLY OF THE CRIB

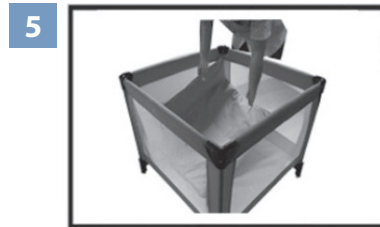
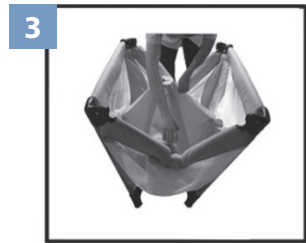
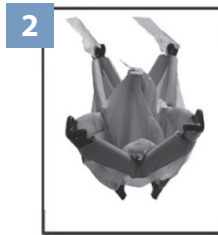

## TO FOLD THE CRIB

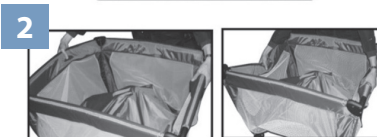
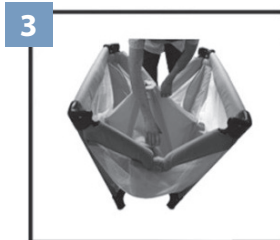
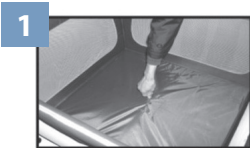

**IMPORTANT: Keep for future reference - READ CAREFULLY****ASSEMBLY OF THE CRIB**

1. Remove crib from travel bag.

Unfasten the Velcro straps that secure the mattress around the crib.

2. Put the four legs of the crib open, on a flat surface, while holding up the base of the crib.

3. Pull upwards on the side rails until they lock into place.

4. Push the centre of the base of the crib down until it is horizontally positioned and locks into place.

**NOTE:** the base of the crib must not be pushed down until the rails are locked into place, as the base forms the safety lock. The arms will not lock into place when the safety lock is engaged; in that case, you will need to pull up the base and lock the arms again.

5. Place the mattress, padded side up, into the base of the crib.

**NOTE:** check that the rails are securely locked and that the base is sitting flat before using the crib.

**TO FOLD THE CRIB**

1. Remove the mattress from the crib.

Hold the strap up and pull up vertically until about 10 cm below the side rails.

2. Hold the lock button upward in the centre of the rails.

Hold the button in and lift the rail slightly to release the lock.

3. Push each rail down, while holding the button, ensuring that both halves of the rail have unlocked and fold together. Gather the frame of the crib together.

4. Wrap the mattress around the closed crib and secure the Velcro straps.

5. Pull the travel bag over the crib and zip up the bag.

**WARNING**

- Do not leave objects of any kind inside the travel cot. There is always the danger that items could be swallowed (danger of suffocation) and the risk of strangulation.
- All screwed and clampable fastening parts must always be firmly tightened. Please check regularly.
- Never place the travel cot close to open fire (fireplace, grill, etc.) or other places with elevated heat.
- Never use the travel cot without the mattress.
- Do not use the travel cot when parts of the fixture are defective or missing.
- To clean the travel cot, use only warm water, soap, or a mild detergent.

EN12227: 2010